

THIS DRAWING IS UNPUBLISHED. RELEASED FOR PUBLICATION 2018  
 © COPYRIGHT 2018 BY TYCO ELECTRONICS JAPAN G.K. ALL RIGHTS RESERVED.

REVISIONS				
P	LTR	DESCRIPTION	DATE	APVD
K		REVISED PER ECR-16-006694	19MAY2016	K.K E.T
L		REVISED PER ECR-18-000718	19JAN2018	M.J E.I

1-178128-3: AS SHOWN.  
 REFER TO SHEET 1 FOR 2,3,4 POS.

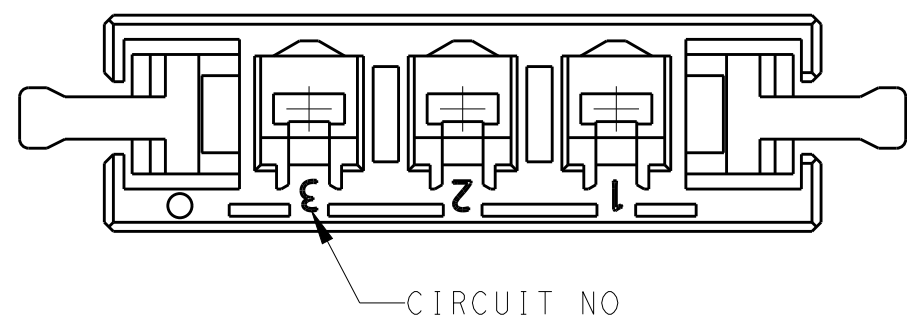
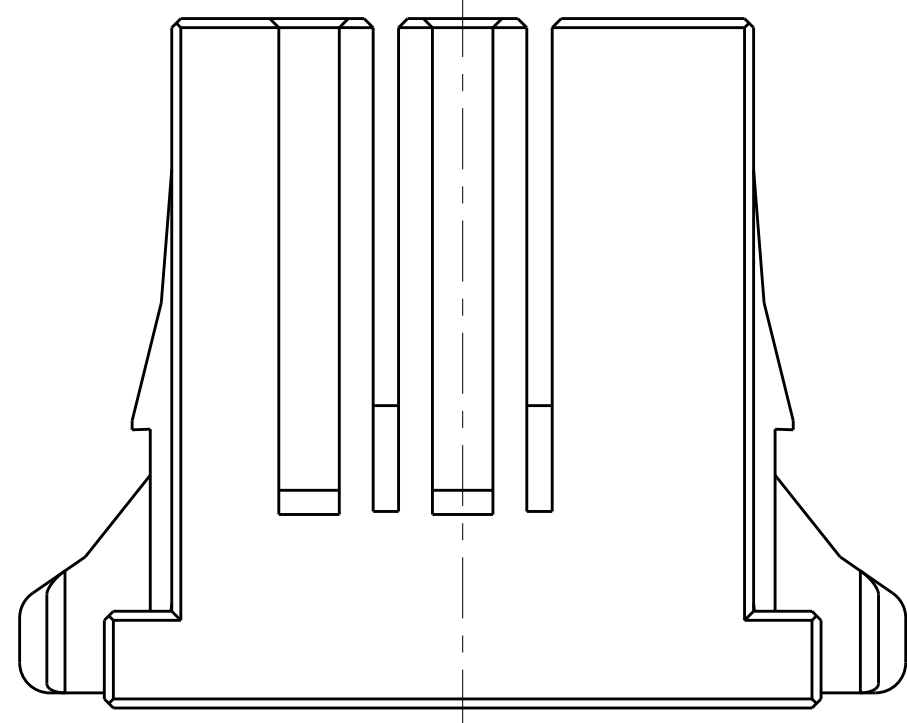
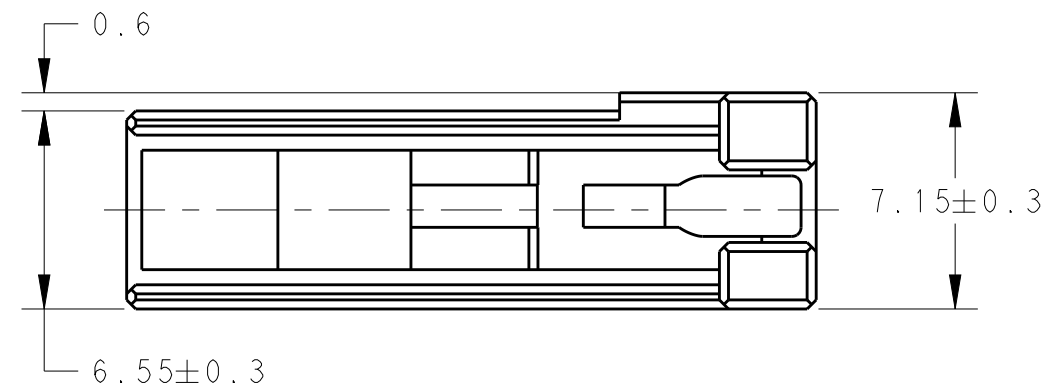
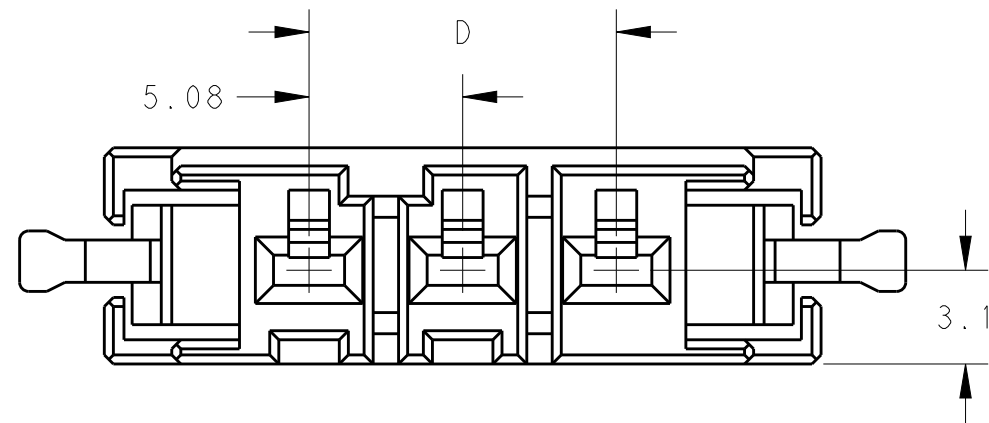
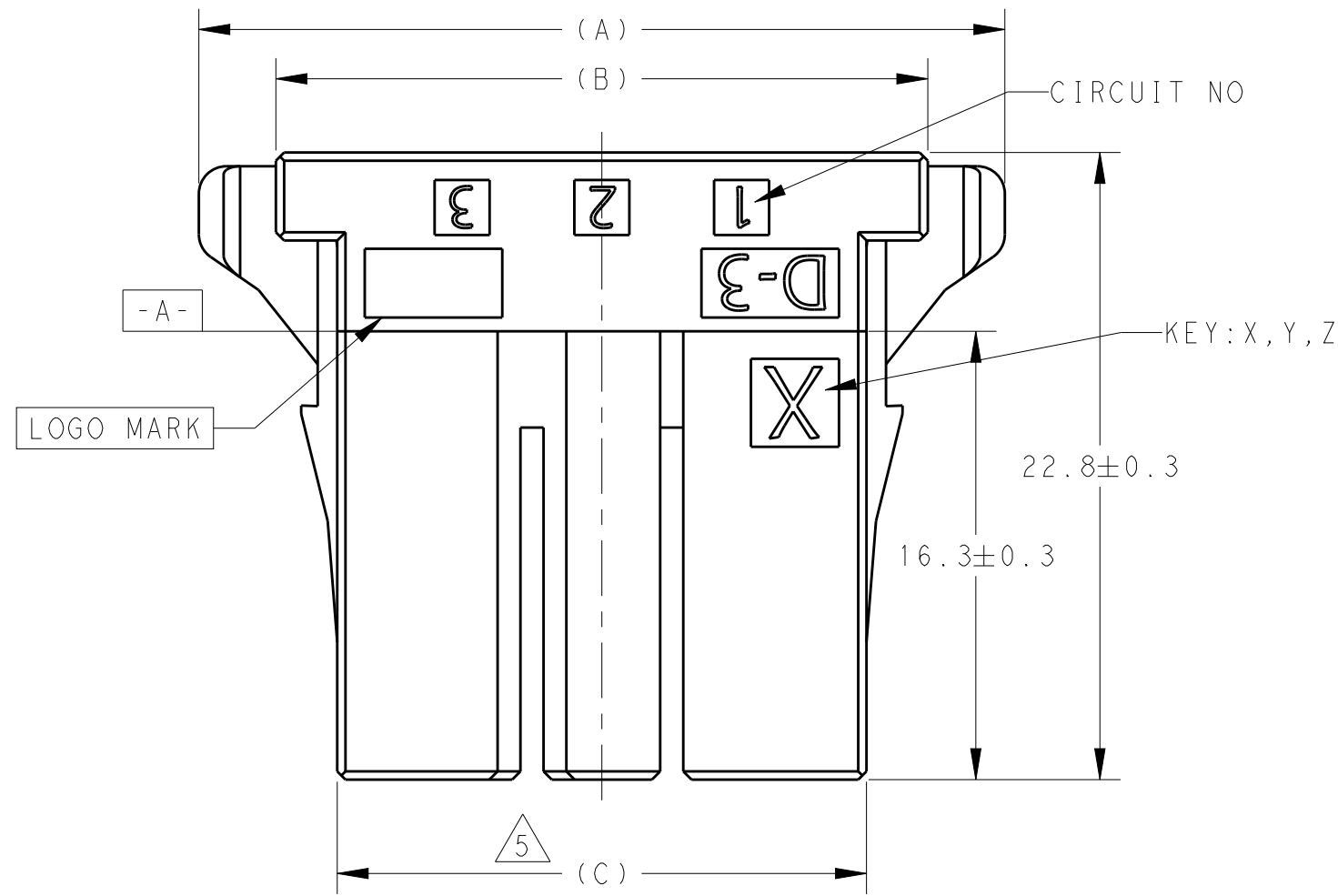

- 1 MATERIAL: GLASS FILLED THERMO PLASTIC, POLYESTER. COLOR: BLACK.
- 2 NOTE DELETED.
- 3 PRODUCT SPEC: 108-5349.
- 4 THE SHAPE, SIZE AND POSITION OF THE CHARACTER SHOW THE OUTLINE THEY DON'T SHOW DETAILS
- 5 THIS DIMENSION MUST BE MEASURED AT -A- OF HSG.

	Y	15.24	24.32	29.18	34.78	2-178128-4
	X	15.24	24.32	29.18	34.78	1-178128-4
	Z	10.16	19.24	24.10	29.7	3-178128-3
	Y	10.16	19.24	24.10	29.7	2-178128-3
	X	10.16	19.24	24.10	29.7	1-178128-3
	Y	5.08	14.16	19.02	24.62	2-178128-2
	X	5.08	14.16	19.02	24.62	1-178128-2
KEYING LOCATION	KEYING	D	C	B	A	PART NO

THIS DRAWING IS A CONTROLLED DOCUMENT.

DIMENSIONS: mm	TOLERANCES UNLESS OTHERWISE SPECIFIED:	DWN N. MATSUBARA 01DEC93	TE Connectivity NAME DYNAMIC D-3200, 5.08 PITCH RECEPTACLE HOUSING(KEY: X,Y) SIZE CAGE CODE DRAWING NO RESTRICTED TO A200779 C-178128
	0 PLC ±	CHK S. MANABE 13DEC95	
	1 PLC ±0.2	APVD S. MANABE 13DEC95	
	2 PLC ±0.25	PRODUCT SPEC 108-5349	
	3 PLC ±0.3	APPLICATION SPEC -	WEIGHT -
	4 PLC ±	CUSTOMER DRAWING	SCALE 4:1 SHEET 1 OF 2 REV L
MATERIAL	ANGLES ±3°		
	FINISH -		

THIS DRAWING IS UNPUBLISHED. RELEASED FOR PUBLICATION 2018  
 © COPYRIGHT 2018 BY TYCO ELECTRONICS JAPAN G.K. ALL RIGHTS RESERVED.

REVISIONS				
P	LTR	DESCRIPTION	DATE	APVD
-		SEE SHEET 1	-	-

1-178128-5: AS SHOWN.  
 REFER TO SHEET 2 FOR 5,6 POS.

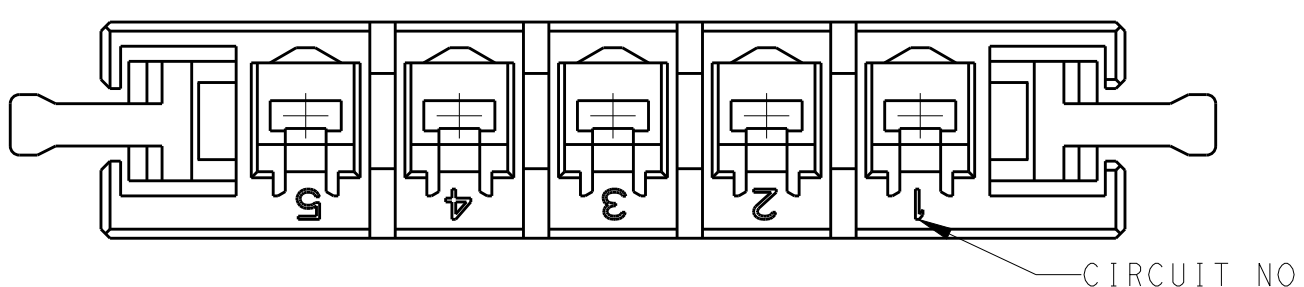
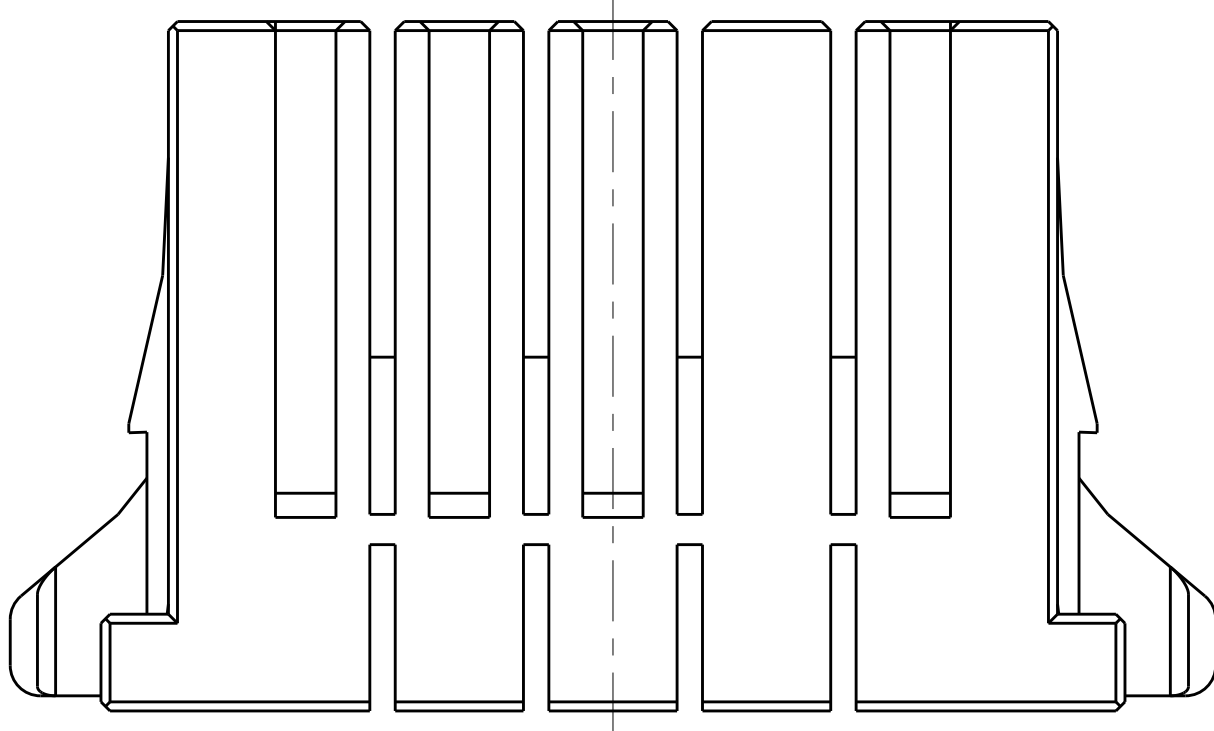
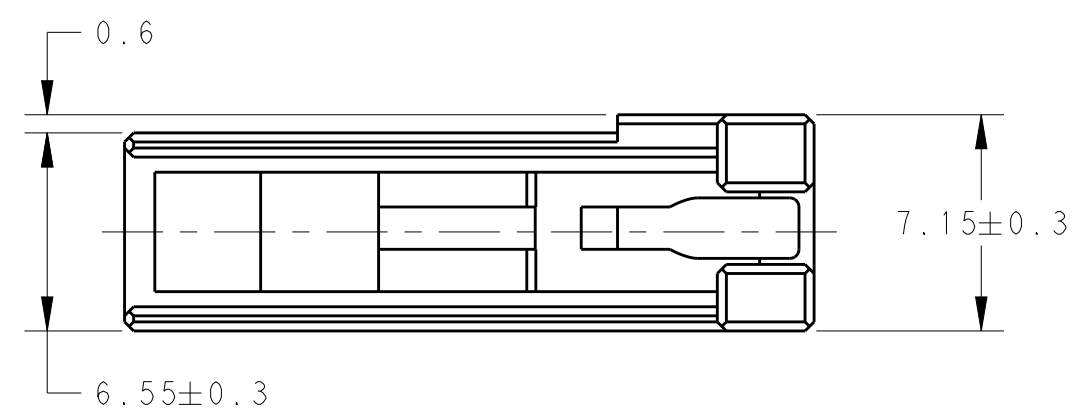
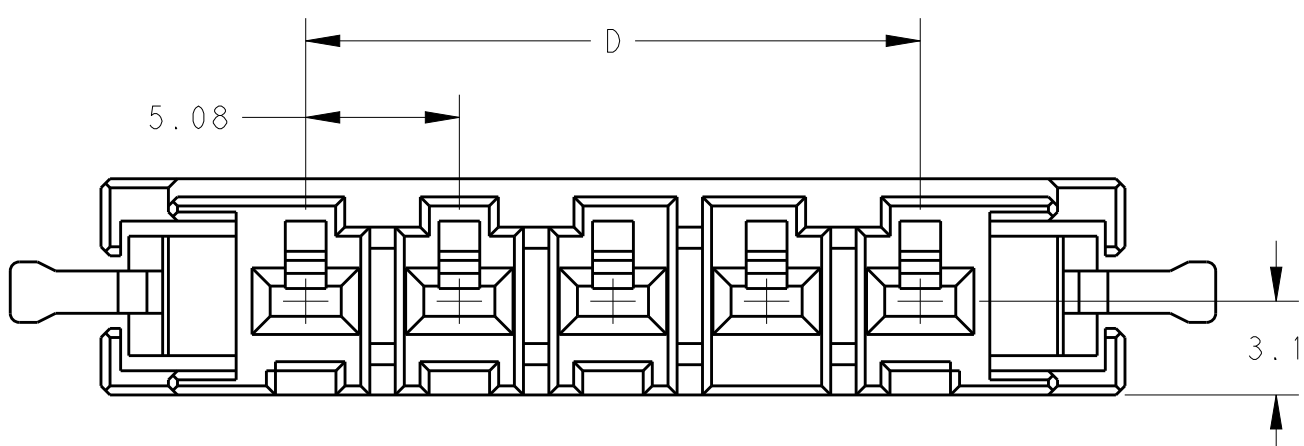
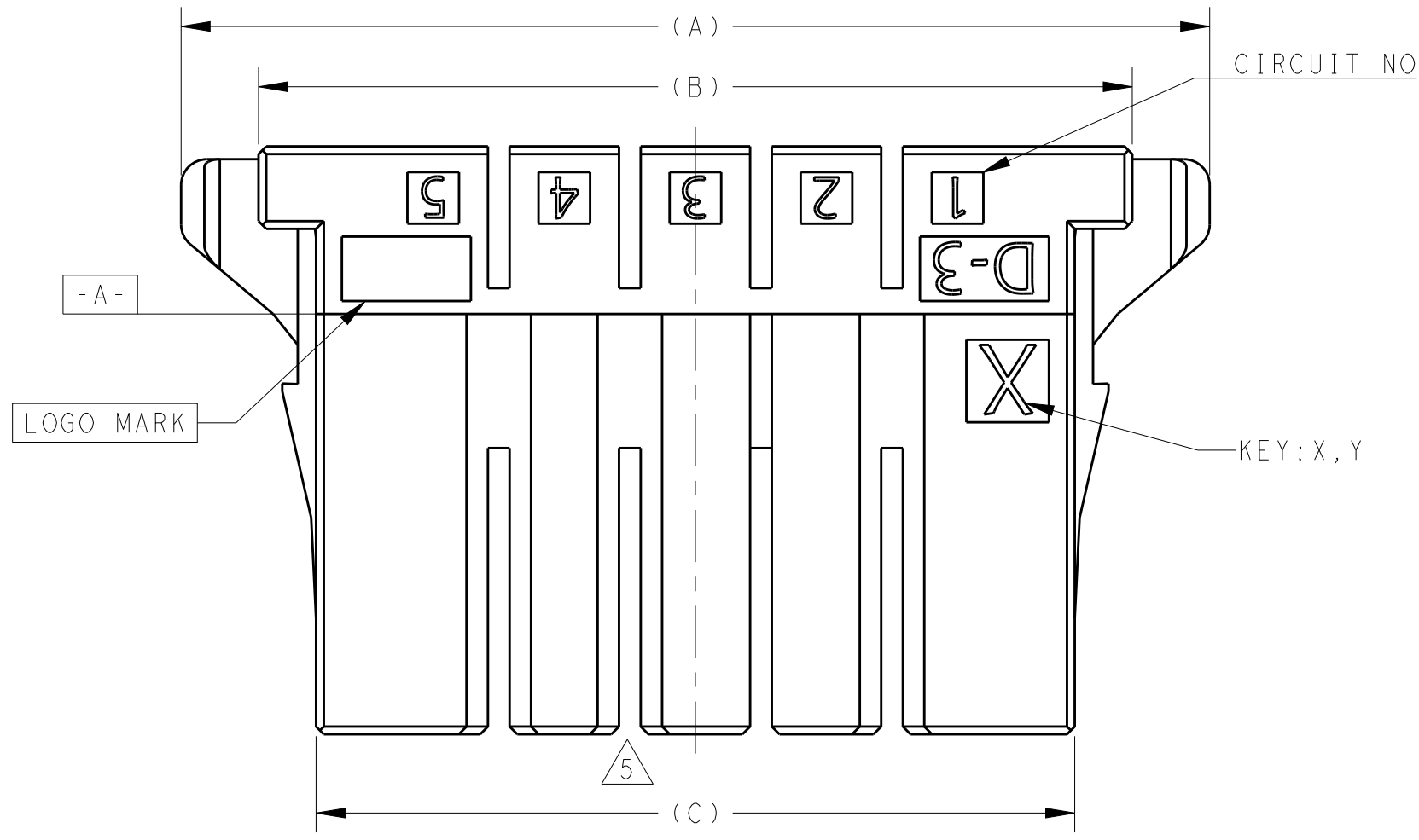

	Y	25.4	34.48	39.34	44.94	2-178128-6	
	X	25.4	34.48	39.34	44.94	1-178128-6	
	Y	20.32	29.4	34.26	39.86	2-178128-5	
	X	20.32	29.4	34.26	39.86	1-178128-5	
KEYING LOCATION		KEYING	D	C	B	A	PART NO

THIS DRAWING IS A CONTROLLED DOCUMENT.		DWN SEE SHEET 1	TE Connectivity NAME DYNAMIC D-3200, 5.08 PITCH RECEPTACLE HOUSING(KEY: X,Y)			
DIMENSIONS:		CHK SEE SHEET 1				
mm		APVD SEE SHEET 1				
TOLERANCES UNLESS OTHERWISE SPECIFIED:		PRODUCT SPEC SEE SHEET 1				
0 PLC ±		APPLICATION SPEC	SIZE	CAGE CODE	DRAWING NO	RESTRICTED TO
1 PLC ± SEE SHEET 1		WEIGHT	A2	00779	C-178128	-
2 PLC ±		CUSTOMER DRAWING	SCALE	SHEET	OF	REV
3 PLC ±			4:1	2	2	L
4 PLC ±						
ANGLES ±						
FINISH -						
MATERIAL SEE SHEET 1						

## X-ON Electronics

Largest Supplier of Electrical and Electronic Components

*Click to view similar products for [Headers & Wire Housings](#) category:*

*Click to view products by [TE Connectivity](#) manufacturer:*

Other Similar products are found below :

[892-18-020-10-001101](#) [58102-G61-06LF](#) [582553-1](#) [0009485154](#) [009176003701906](#) [0050291907](#) [LY20-4P-DT1-P1E-BR](#) [02.125.8002.8](#)  
[609-3404](#) [61062-3](#) [61082-181009](#) [622-3653LF](#) [63453-116](#) [636-1030](#) [636-1427](#) [636-3427](#) [636-4007](#) [641938-9](#) [641991-4](#) [644827-2](#) [65817-](#)  
[010LF](#) [65817-015LF](#) [65863-015LF](#) [66207-023LF](#) [67095-007LF](#) [67601157](#) [68645-018](#) [68648-049](#) [70.362.1628.0](#) [70-4210](#) [70-4226B](#) [70-](#)  
[4853B](#) [707-5020](#) [707-5028](#) [71.350.2428.0](#) [71918-208LF](#) [71961-016LF](#) [733-134](#) [733-162](#) [754199-000](#) [760-3052](#) [787-8014-00](#) [79531-3000](#)  
[FCN-360C032-B](#) [FCN-367T-T012/H](#) [FCN-723D010/2](#) [80.063.4001.1](#) [800-90-001-10-001000](#) [800-90-010-10-002000](#) [801-43-002-10-013000](#)