

THIS DRAWING IS UNPUBLISHED. RELEASED FOR PUBLICATION 20
 © COPYRIGHT 20 BY Tyco Electronics Japan G.K. ALL RIGHTS RESERVED.

1. MATERIAL: HOUSING: GLASS FILED THERMO PLASTIC
 POLYESTER(94V-0), COLOR: BLACK
 CONTACT: COPPER ALLOY
 RETENTION LEG: PRE-TIN COPPER ALLOY

- 2. FINISH(ALL OVER): NICKEL PL. 1.27μmMIN
- 3. FINISH(CONTACT AREA): GOLD PL. 0.38μmMIN OR
 Sn PLATED 1.0μmMIN AFTER 2
- 4. FINISH(CONTACT TAIL): TIN PL. 2μmMIN AFTER 2
- 5. THE SHAPE, SIZE AND POSITION OF THE CHARACTER SHOW THE OUTLINE. THEY DON'T SHOW DETAILS.
- 6. THE KEYING ARRANGEMENT OF "Y" IS 2.65REF

REVISONS		DATE	DWN	APVD
P	LTR	DESCRIPTION		
B		REVISED	14JUL2010	HMR TM
C		REVISED	17DEC2012	H.M N.Y
C1		REVISED ECR-17-005500	5MAY2017	N.W C.W
C2		REVISED	04FEB2021	F.Z R.B

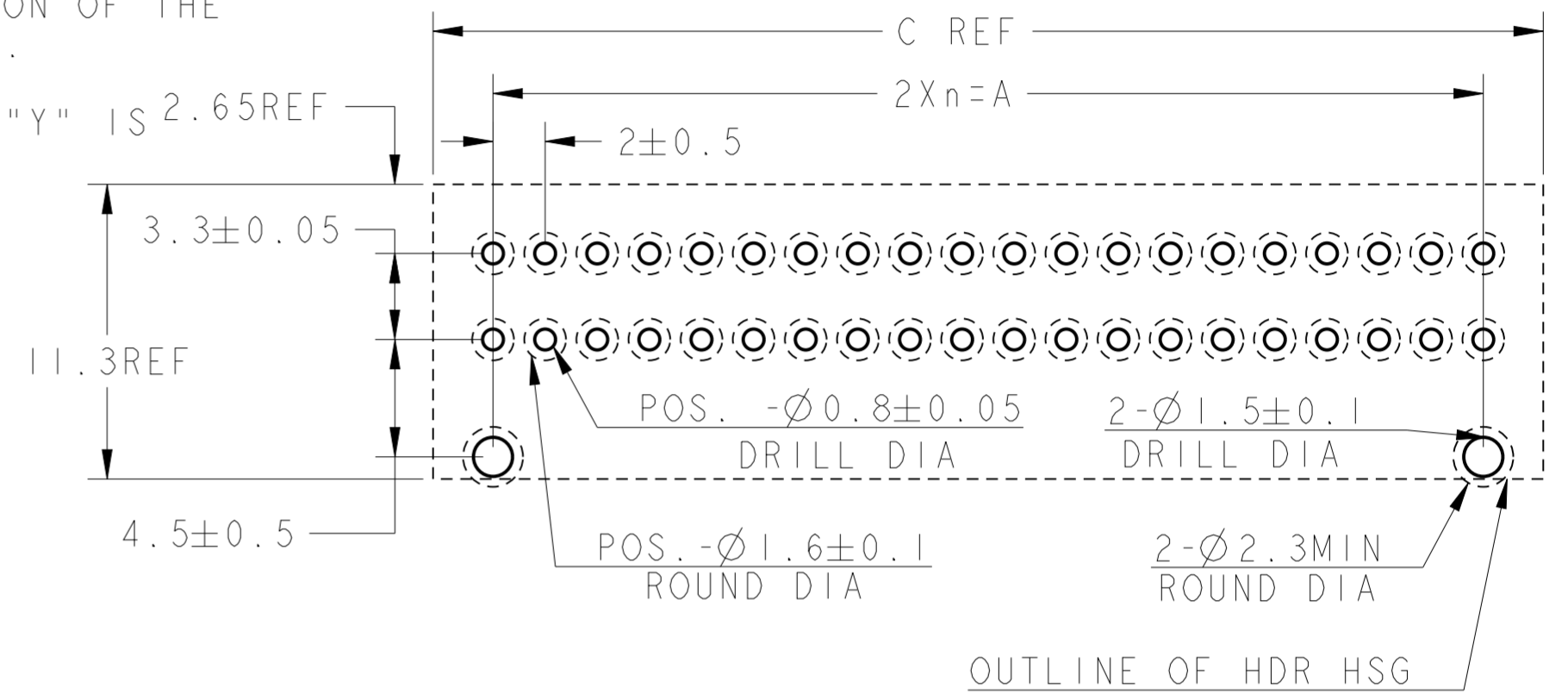
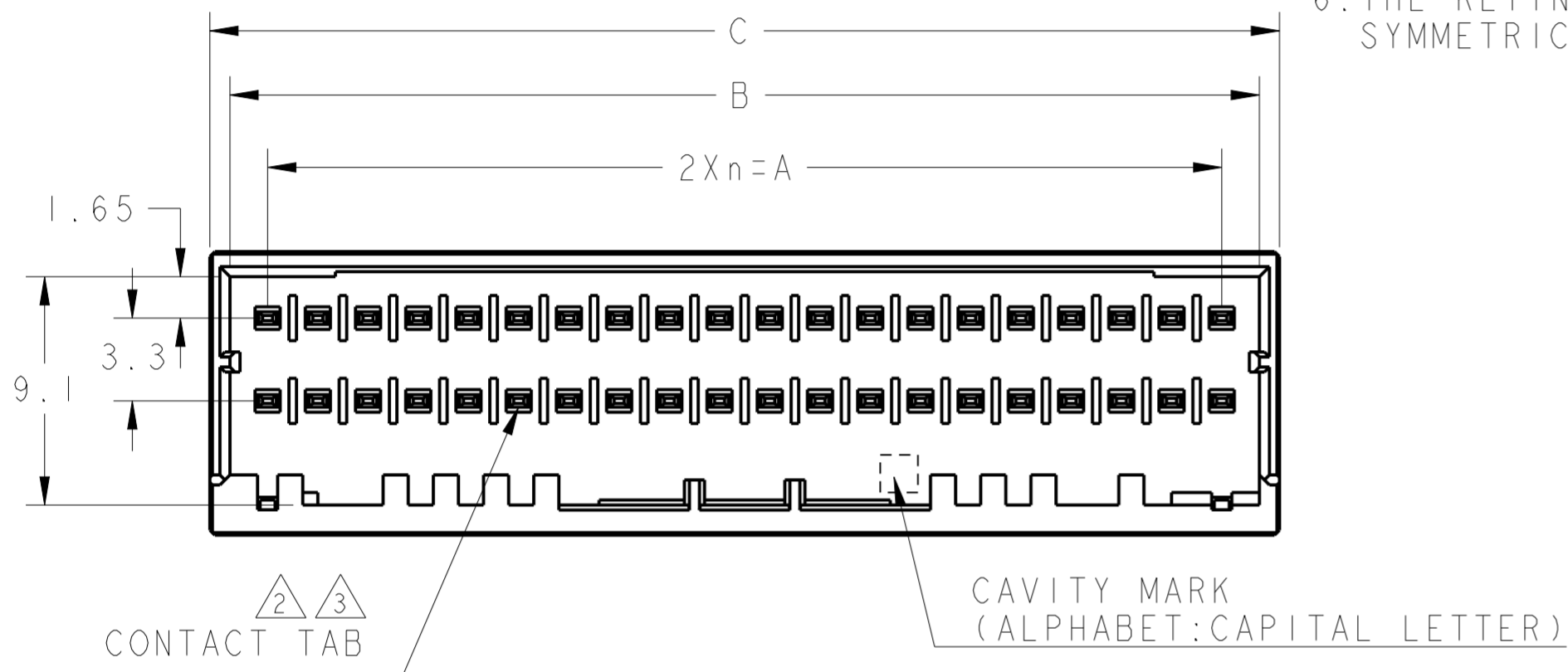

RECOMMEND PC BOARD HOLE PATTERN
 : CONNECTOR MOUNT SIDE (NOT ACCUMULATE TOLERANCE)
 PC BOARD THICKNESS : 1.0~1.6±0.1

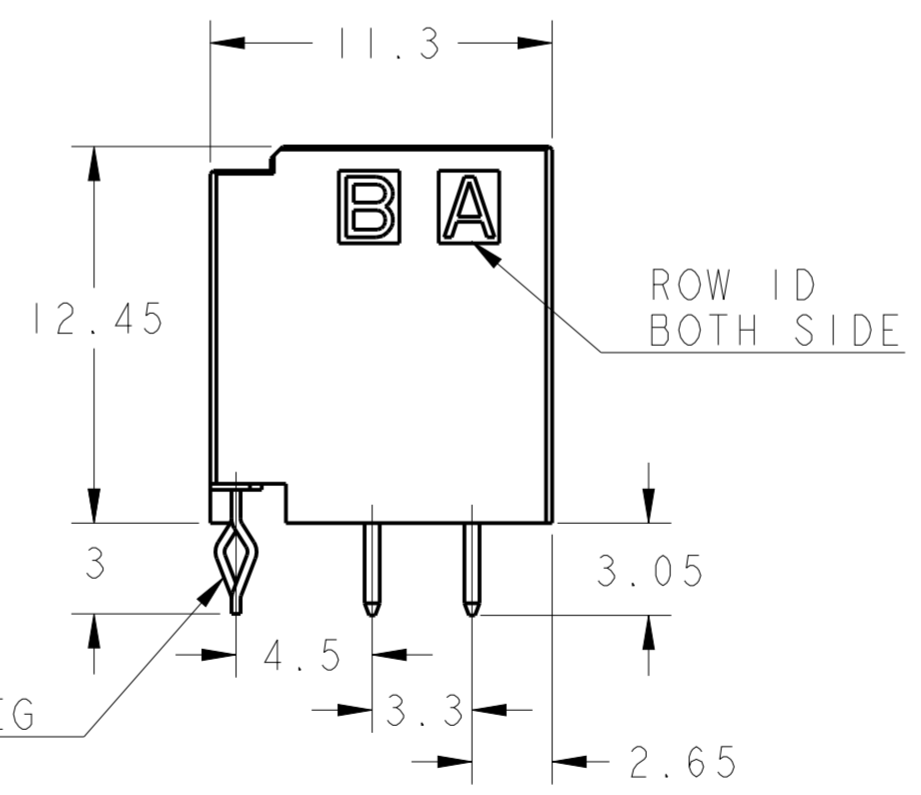
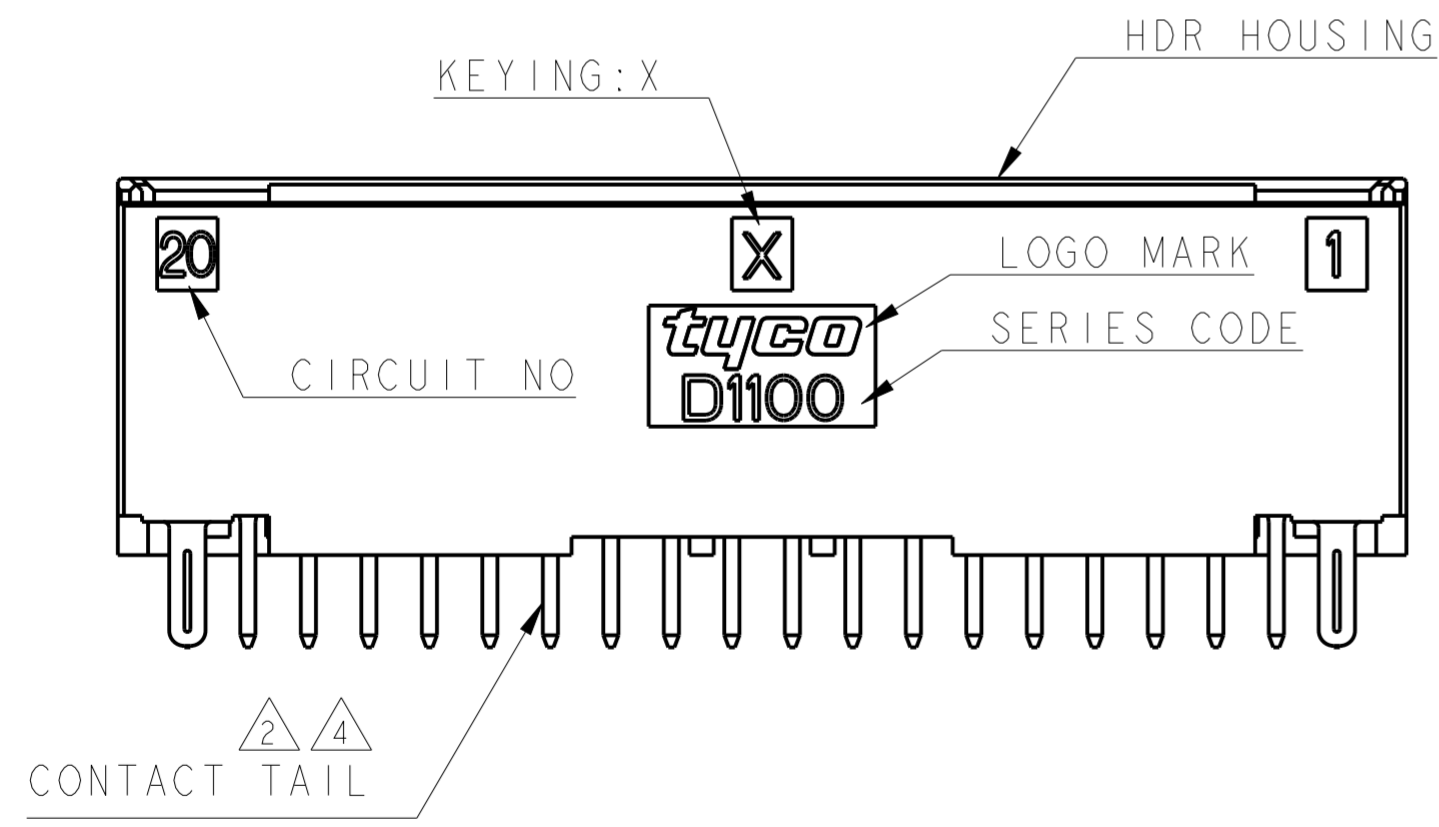

POS	KEY	n	A	B	C	FINISHED	PART NO
40	Y	19	38.0	41.0	42.6	GOLD PLATED	2-1827872-0
40	X	19	38.0	41.0	42.6	Sn PLATED	6-1827872-0
40	X	19	38.0	41.0	42.6	GOLD PLATED	1-1827872-0
34	Y	16	32.0	35.0	36.6	GOLD PLATED	2-1827872-7
34	X	16	32.0	35.0	36.6	Sn PLATED	6-1827872-7
34	X	16	32.0	35.0	36.6	GOLD PLATED	1-1827872-7
32	X	15	30.0	33.0	34.6	Sn PLATED	6-1827872-6
32	X	15	30.0	33.0	34.6	GOLD PLATED	1-1827872-6
30	X	14	28.0	31.0	32.6	Sn PLATED	6-1827872-5
30	X	14	28.0	31.0	32.6	GOLD PLATED	1-1827872-5
28	X	13	26.0	29.0	30.6	Sn PLATED	6-1827872-4
28	X	13	26.0	29.0	30.6	GOLD PLATED	1-1827872-4
26	X	12	24.0	27.0	28.6	Sn PLATED	6-1827872-3
26	X	12	24.0	27.0	28.6	GOLD PLATED	1-1827872-3
24	X	11	22.0	25.0	26.6	Sn PLATED	6-1827872-2
24	X	11	22.0	25.0	26.6	GOLD PLATED	1-1827872-2
22	X	10	20.0	23.0	24.6	Sn PLATED	6-1827872-1
22	X	10	20.0	23.0	24.6	GOLD PLATED	1-1827872-1

40POS(X-KEY): 1-1827872-0

THIS DRAWING IS A CONTROLLED DOCUMENT.

DWN: I. KUDO 16MAR2005
 CHK: D. MITSUGI 23AUG2005
 APVD: D. MITSUGI 23AUG2005

TE Connectivity

NAME: DYNAMIC D1100D 2.0mmPITCH HDR ASSY (V-TYPE) 22-40POS

PRODUCT SPEC: 108-78268/78298
 APPLICATION SPEC: 114-5377

MATERIAL: -
 FINISH: -

WEIGHT: -

SCALE: 4:1
 SHEET 1 OF 3
 REV C2

THIS DRAWING IS UNPUBLISHED. RELEASED FOR PUBLICATION 20
 © COPYRIGHT 20 BY Tyco Electronics Japan G.K. ALL RIGHTS RESERVED.

REVISONS				DATE	DWN	APVD
LOC	DIST	P	LTR	DESCRIPTION		
J	-			SEE SHEET 1 OF 3		

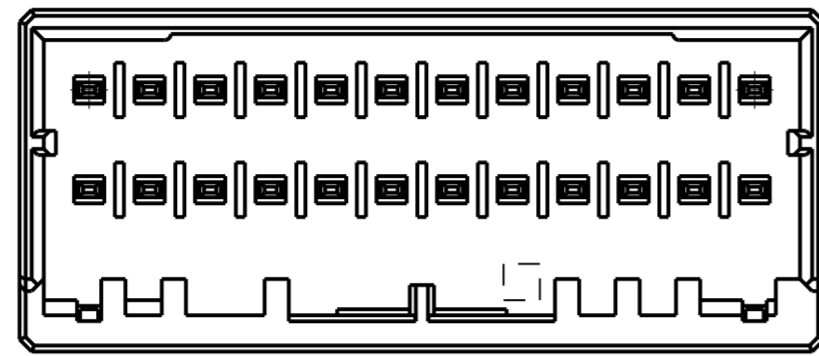
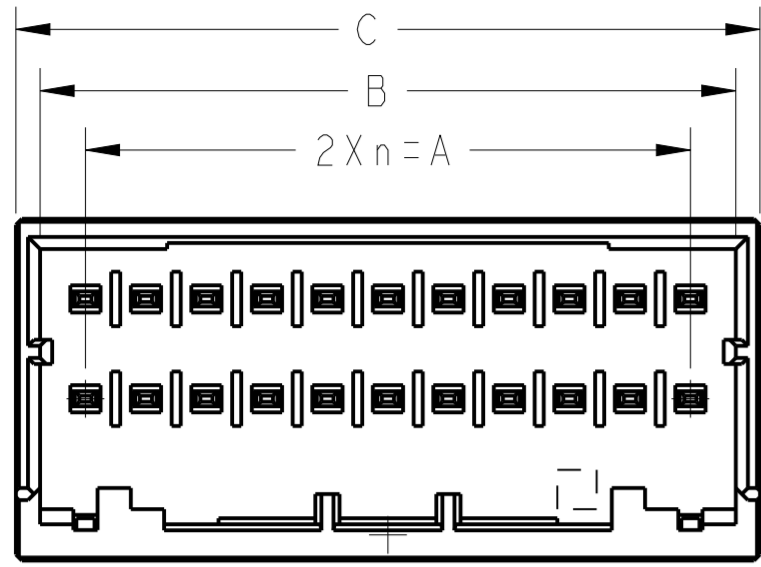

SCALE 4:1

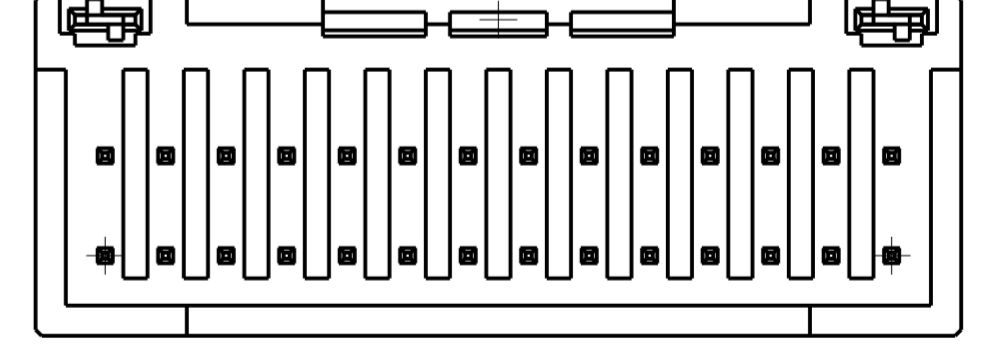
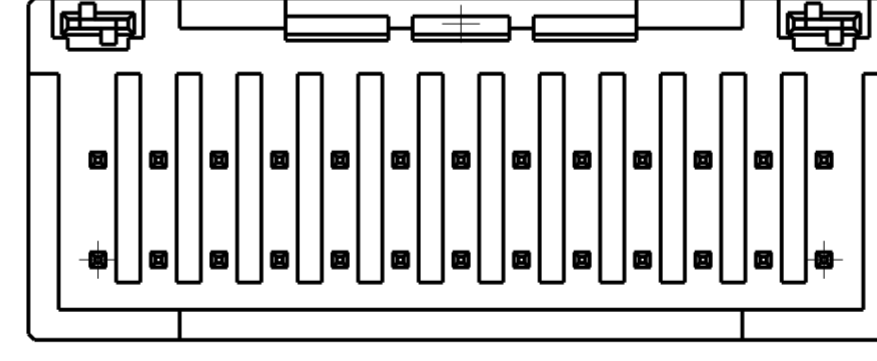
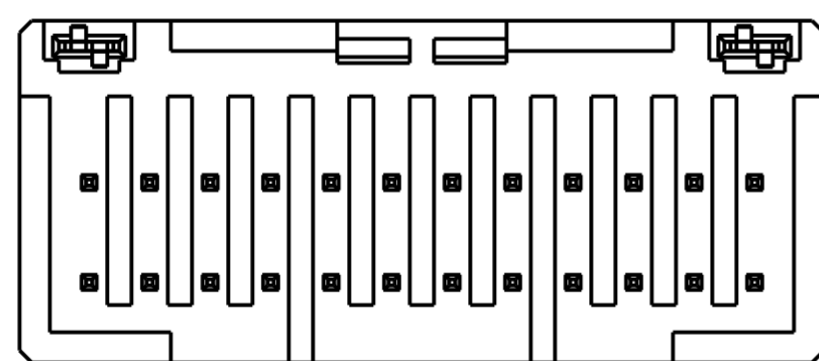
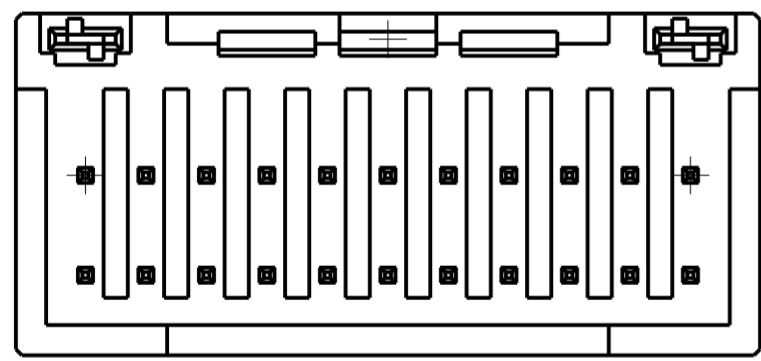
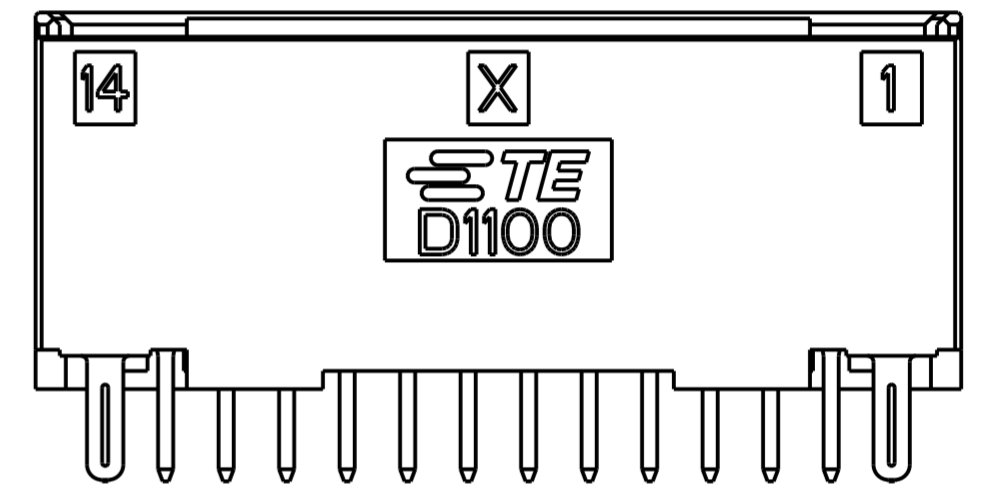
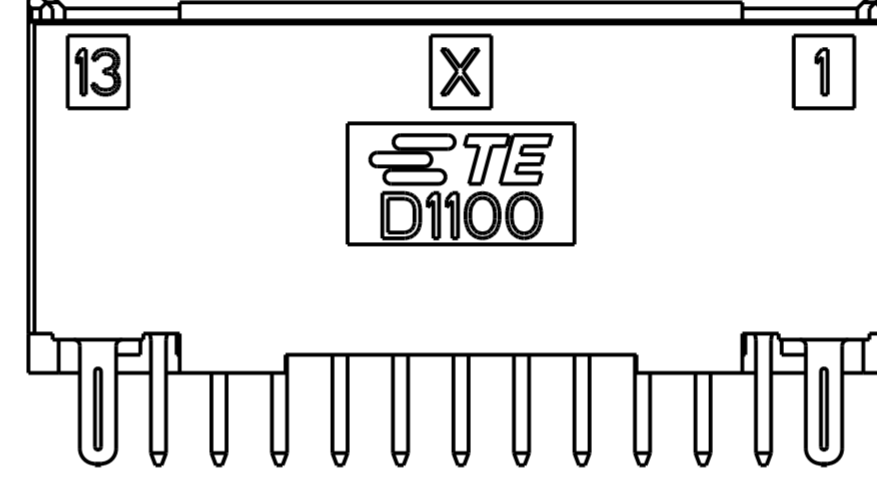
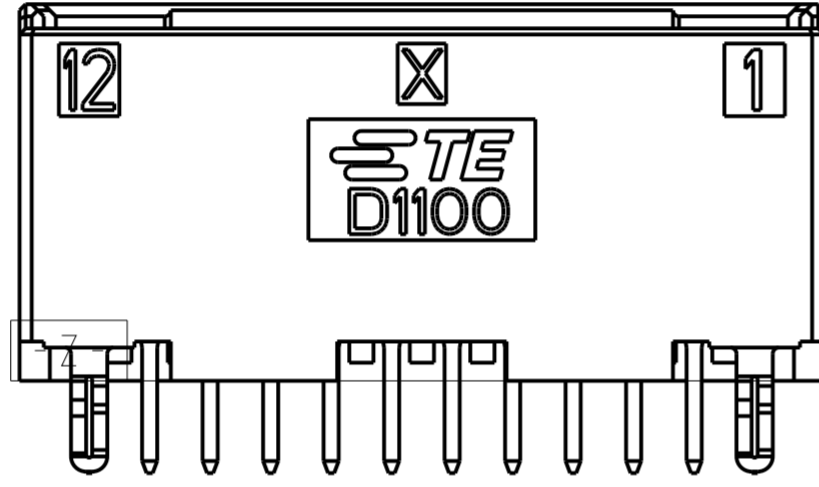
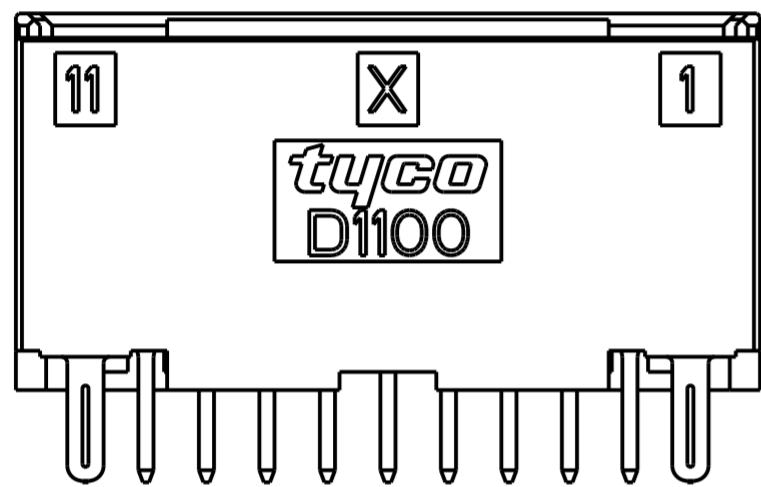
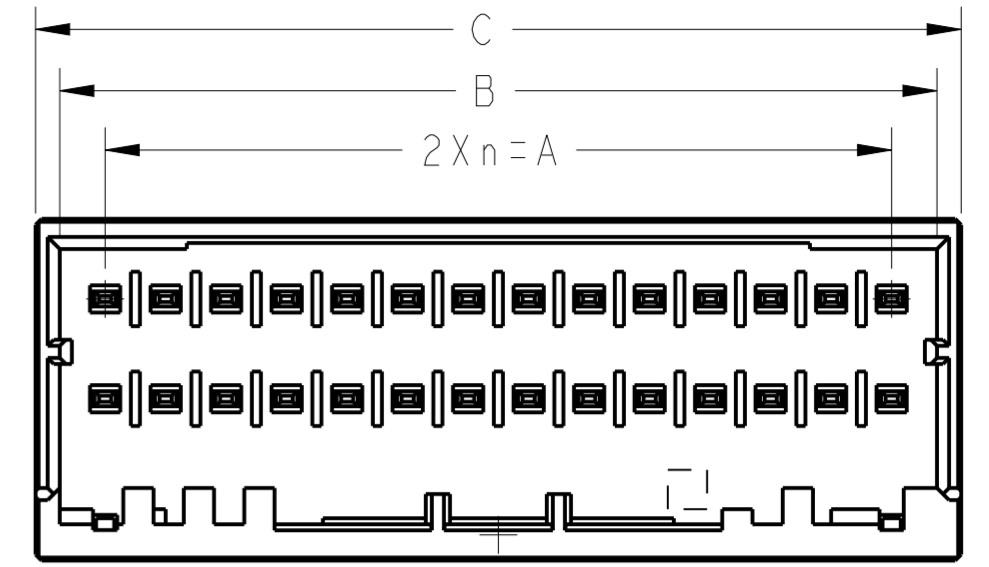
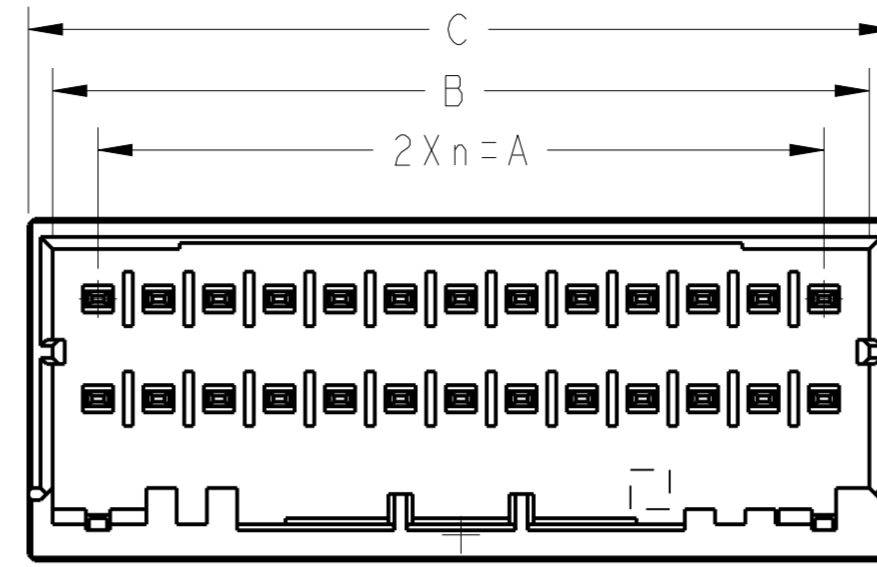

22POS(X-KEY):1-1827872-1

22POS(X-KEY):1-1827872-2

26POS(X-KEY):1-1827872-3

28POS(X-KEY):1-1827872-4

THIS DRAWING IS A CONTROLLED DOCUMENT		DWN T. KUDO 16MAR2005	TE Connectivity	
DIMENSIONS: mm		CHK D. MITSUGI 23AUG2005		
TO DIMENSIONS UNLESS OTHERWISE SPECIFIED: 1. PLC ±0.5 2. PLC ±0.13 3. PLC ±0.013 4. PLC ±0.0001 ANGLES ± FINISH		APVD D. MITSUGI 23AUG2005	NAME DYNAMIC D1100D 2.0mmPITCH HDR ASSY (V-TYPE) 22-40POS	
MATERIAL		PRODUCT SPEC 108-78268	RESTRICTED TO	
		APPLICATION SPEC 114-5377	SIZE A200779	DRAWING NO. C-1827872
		WEIGHT -	SCALE 4:1 SHEET 2 OF 3 REV C2	
		CUSTOMER DRAWING		

THIS DRAWING IS UNPUBLISHED. RELEASED FOR PUBLICATION 20
 © COPYRIGHT 20 BY Tyco Electronics Japan G.K. ALL RIGHTS RESERVED.

LOC		DIST		REVISIONS			
P	LTR	DESCRIPTION	DATE	DWN	APVD		
J	-	SEE SHEET 11 OF 3					

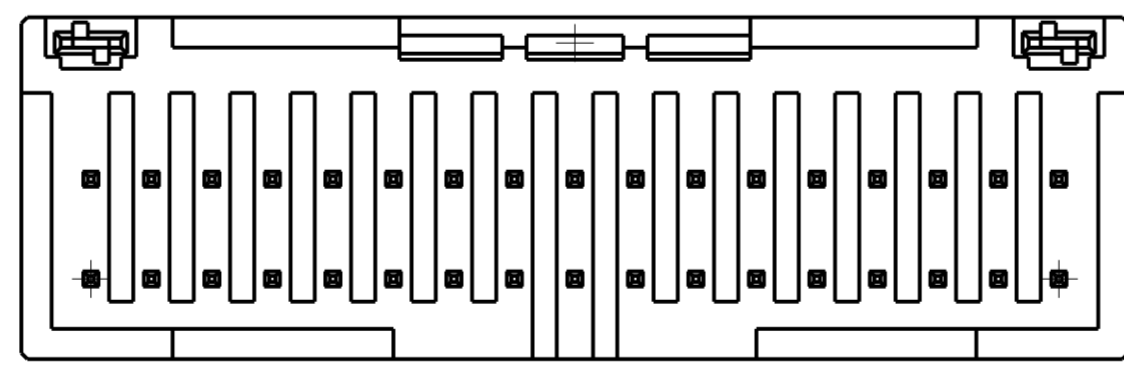
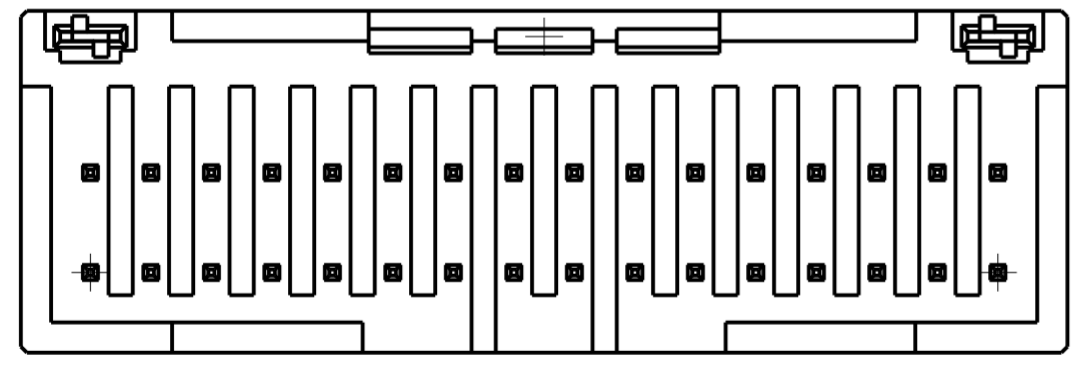
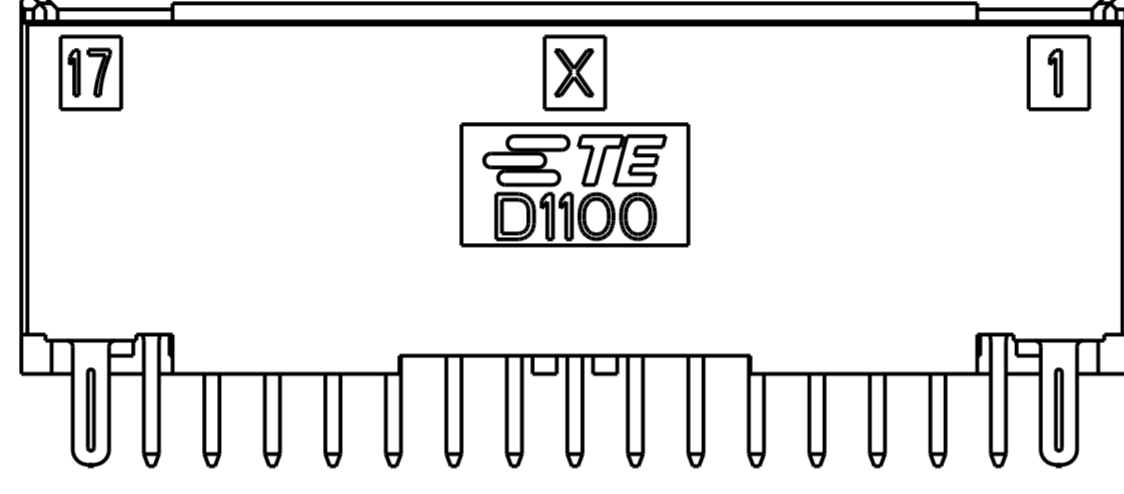
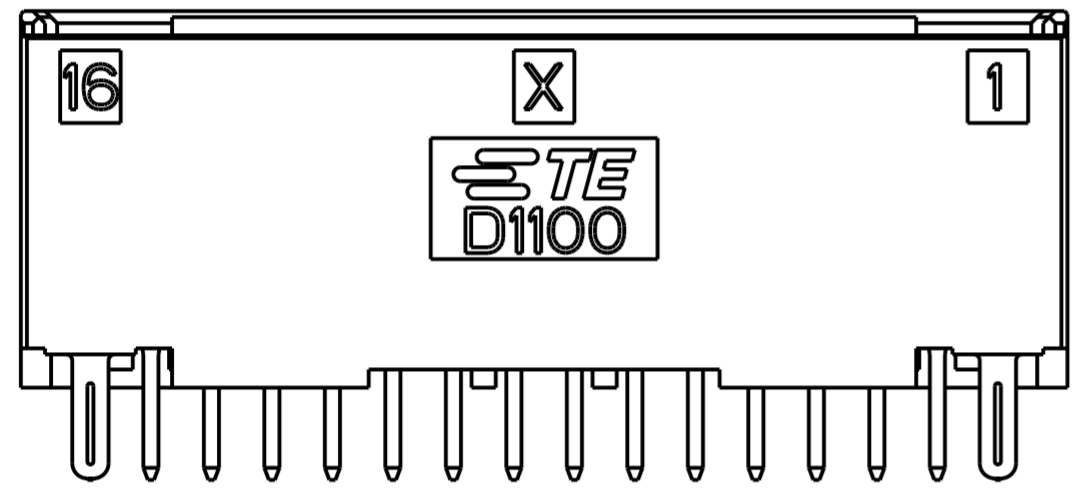
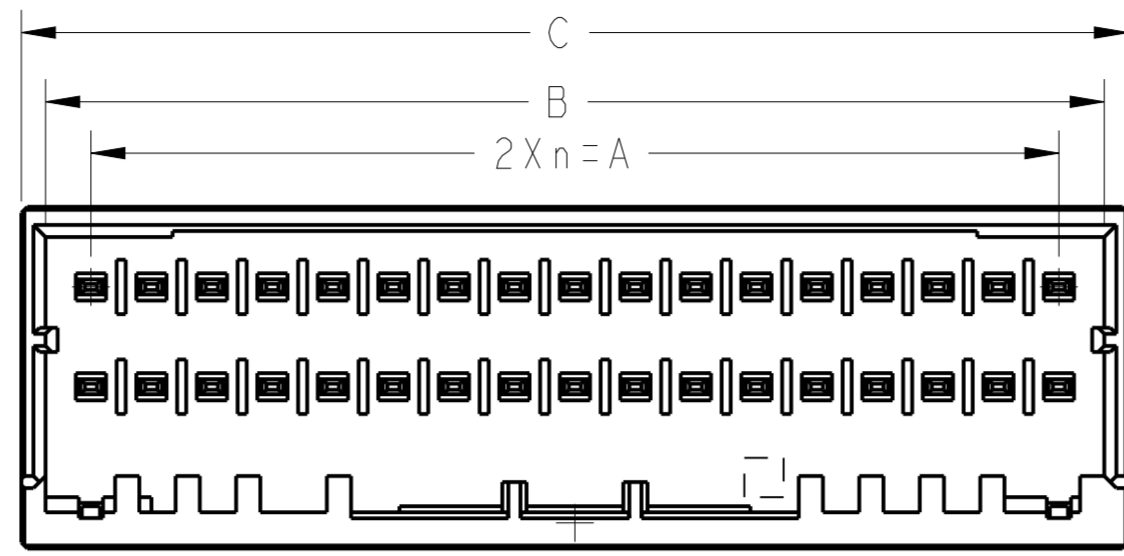
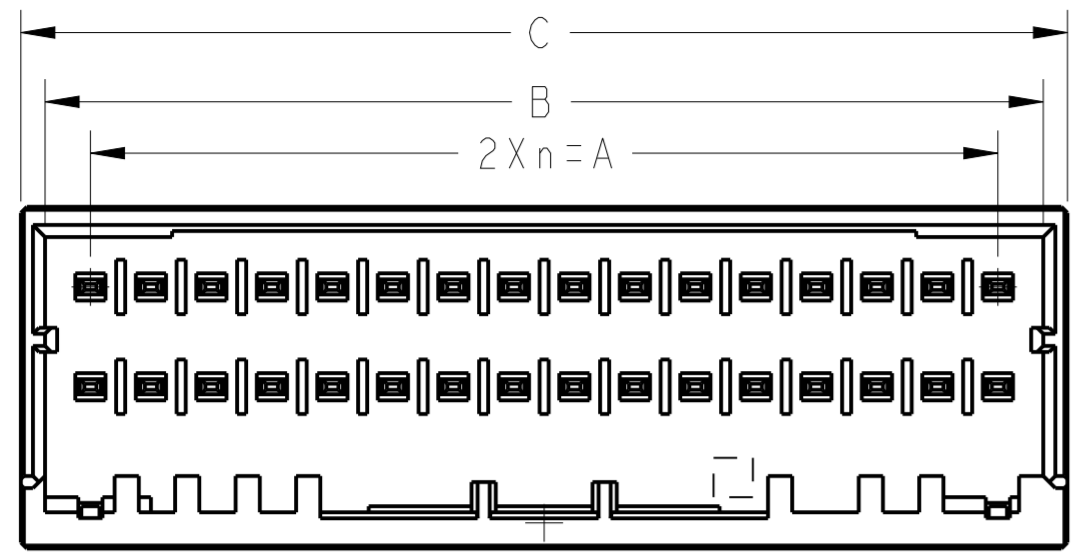

32POS(X-KEY):1-1827872-6

34POS(X-KEY):1-1827872-7

THIS DRAWING IS A CONTROLLED DOCUMENT		DWN T. KUDO 16MAR2005	STE TE Connectivity
DIMENSIONS: mm		CHK D. MITSUGI 23AUG2005	
MATERIAL		APVD D. MITSUGI 23AUG2005	NAME DYNAMIC D1100D 2.0mmPITCH HDR ASSY (V-TYPE) 22-40POS
TO DIMENSIONS UNLESS OTHERWISE SPECIFIED: 1. PLC ±0.5 2. PLC ±0.13 3. PLC ±0.013 4. PLC ±0.0001 ANGLES ± FINISH		PRODUCT SPEC 108-78268	SIZE A200779
CUSTOMER DRAWING		APPLICATION SPEC 114-5377	DRAWING NO C-1827872
		WEIGHT -	RESTRICTED TO
		SCALE 4:1	SHEET 3 OF 3
			REV C2

X-ON Electronics

Largest Supplier of Electrical and Electronic Components

Click to view similar products for [Headers & Wire Housings](#) category:

Click to view products by [TE Connectivity](#) manufacturer:

Other Similar products are found below :

[892-18-020-10-001101](#) [58102-G61-06LF](#) [582553-1](#) [0009485154](#) [009176003701906](#) [0050291907](#) [LY20-4P-DT1-P1E-BR](#) [02.125.8002.8](#)
[609-3404](#) [61062-3](#) [61082-181009](#) [622-3653LF](#) [63453-116](#) [636-1030](#) [636-1427](#) [636-3427](#) [636-4007](#) [641938-9](#) [641991-4](#) [644827-2](#) [65817-010LF](#) [65817-015LF](#) [65863-015LF](#) [66207-023LF](#) [67095-007LF](#) [67601157](#) [68645-018](#) [68648-049](#) [70.362.1628.0](#) [70-4210](#) [70-4226B](#) [70-4853B](#) [707-5020](#) [707-5028](#) [71.350.2428.0](#) [71918-208LF](#) [71961-016LF](#) [733-134](#) [733-162](#) [754199-000](#) [760-3052](#) [787-8014-00](#) [79531-3000](#)
[FCN-360C032-B](#) [FCN-367T-T012/H](#) [FCN-723D010/2](#) [80.063.4001.1](#) [800-90-001-10-001000](#) [800-90-010-10-002000](#) [801-43-002-10-013000](#)