

Printed on 3 Feb 2021 16:39 (China Standard Time) from TE304429

LOC	DIST	REVISIONS					
		P	LTR	DESCRIPTION	DATE	DWN	APVD
-	-		CI	REVISED	14JUL2010	HMR	TM
			D	REVISED	17DEC2012	H.M	N.Y
			DI	REVISED	03FEB2021	F.Z	R.B

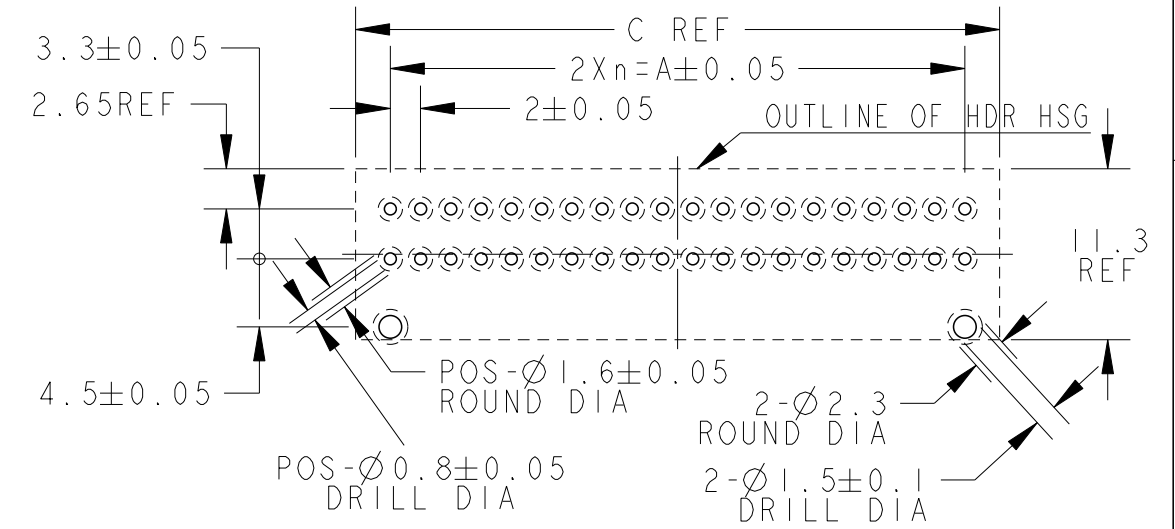

RECOMMEND PC BOARD HOLE PATTERN : CONNECTOR MOUNT SIDE (NOT ACCUMULATE TOLERANCE)
 PC BOARD THICKNESS : 1.0~1.6±0.1

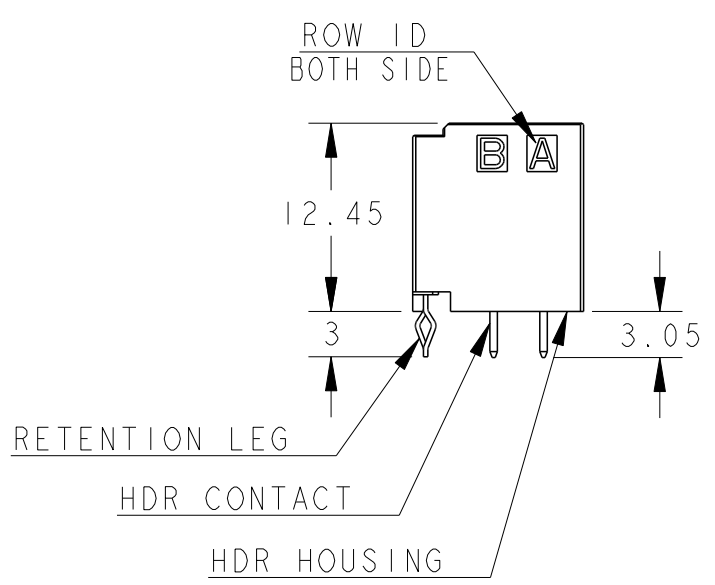
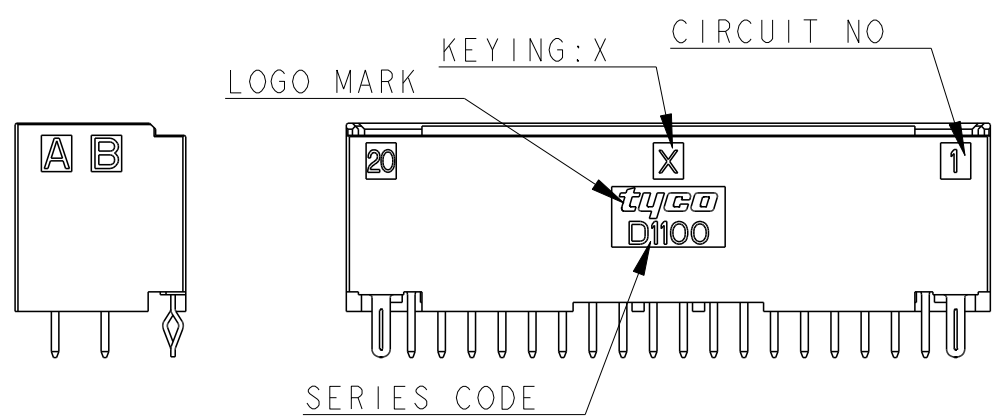
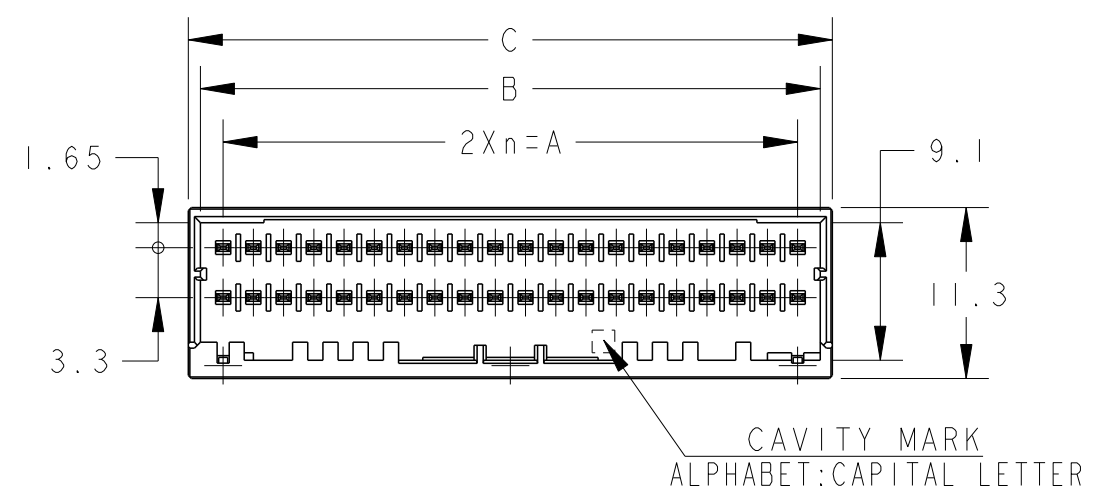
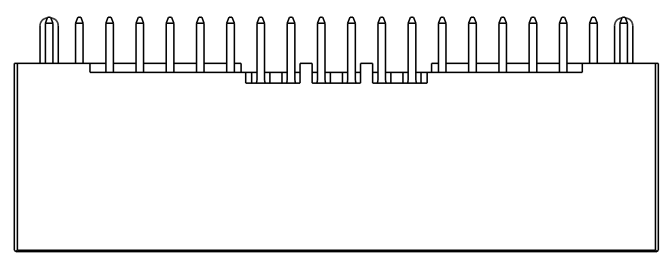
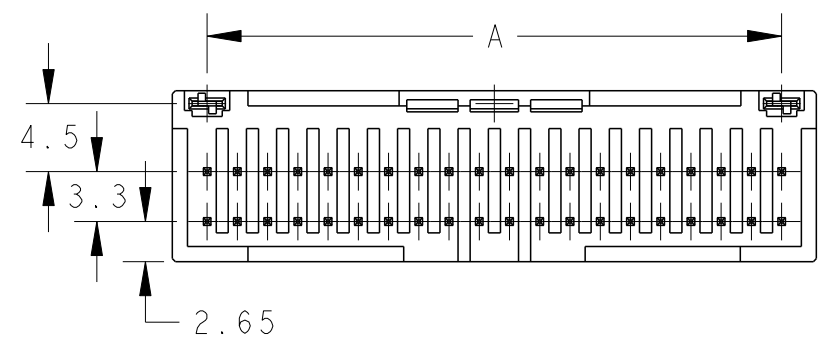

40POS(X-KEY): 1-1871315-0

1. MATERIAL: HOUSING: GLASS FILLED THERMO PLASTIC POLYESTER(94V-0)
 COLOR: BLACK
 CONTACT: PRE-TIN COPPER ALLOY
 RETENTION LEG: PRE-TIN COPPER ALLOY
 2. THE SHAPE, SIZE AND POSITION OF THE CHARACTER SHOW THE OUTLINE. THEY DON'T SHOW DETAILS.

40	X	19	38.0	41.0	42.6	PRE-TIN	1-1871315-0
34	Y	16	32.0	35.0	36.6	PRE-TIN	2-1871315-7
34	X	16	32.0	35.0	36.6	PRE-TIN	1-1871315-7
32	X	15	30.0	33.0	34.6	PRE-TIN	1-1871315-6
30	X	14	28.0	31.0	32.6	PRE-TIN	1-1871315-5
28	X	13	26.0	29.0	30.6	PRE-TIN	1-1871315-4
26	X	12	24.0	27.0	28.6	PRE-TIN	1-1871315-3
24	X	11	22.0	25.0	26.6	PRE-TIN	1-1871315-2
22	X	10	20.0	23.0	24.6	PRE-TIN	1-1871315-1
POS	KEY	n	A	B	C	FINISH	PART NO

THIS DRAWING IS A CONTROLLED DOCUMENT.		DWN T. KUDO 23AUG2005	TE Connectivity	
DIMENSIONS: mm		CHK D. MITSUGI 23AUG2005		
TOLERANCES UNLESS OTHERWISE SPECIFIED: ±0.3, ±5°		APVD D. MITSUGI 23AUG2005	NAME DYNAMIC D1100 SERIES HDR ASSY, V-TYPE, PRE-TIN 22~40POS	
0-PLC ±		PRODUCT SPEC 108-78298	SIZE A3	
1-PLC ±0.1		- 108-137366	CAGE CODE 00779	
2-PLC ±0.01		APPLICATION SPEC 114-5377	DRAWING NO C=1871315	
3-PLC ±0.001		WEIGHT -	RESTRICTED TO -	
4-PLC ±0.0001		CUSTOMER DRAWING	SCALE 2:1	
ANGLES ±			SHEET 1 OF 3	
FINISH -			REV DI	

4

3

2

1

THIS DRAWING IS UNPUBLISHED.

RELEASED FOR PUBLICATION

20

LOC J

DIST -

REVISIONS

© COPYRIGHT 2020 TE Connectivity. All Rights Reserved. ALL RIGHTS RESERVED.

P	LTR	DESCRIPTION	DATE	DWN	APVD
		SEE SHEET 1			

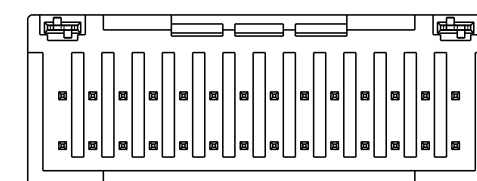
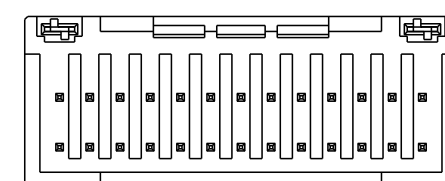
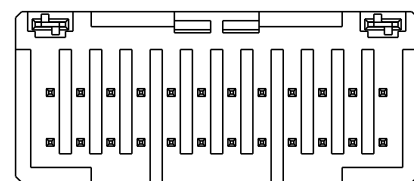
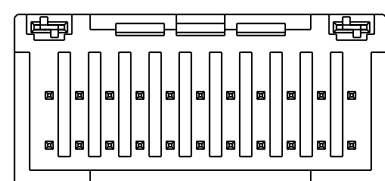
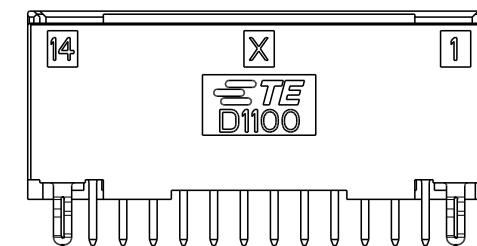
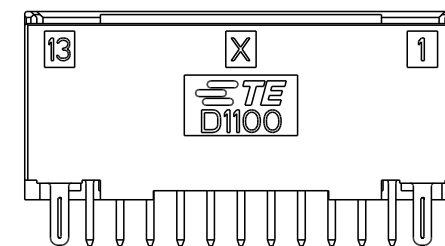
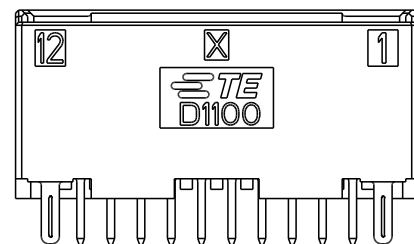
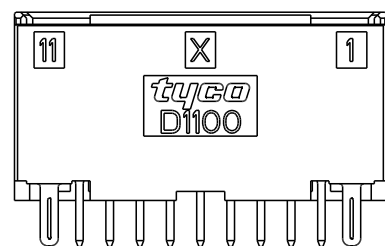
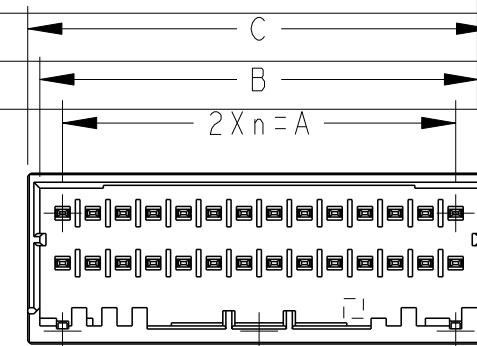
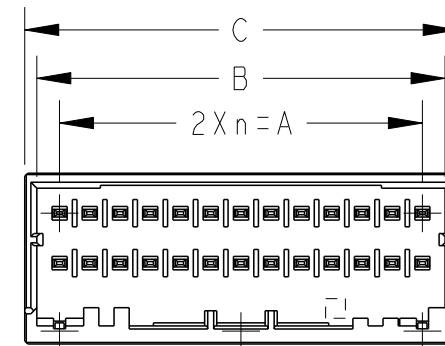
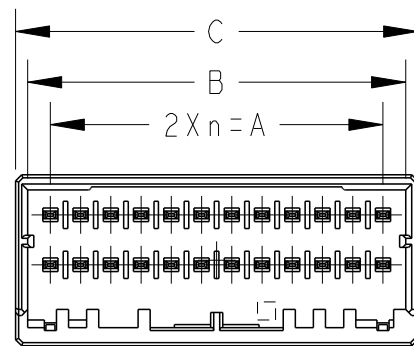
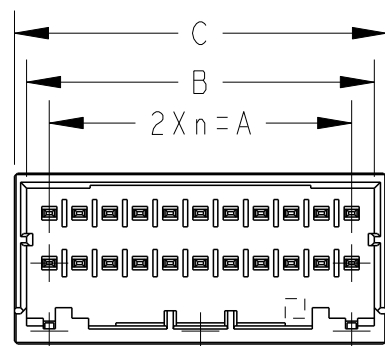

22POS(X-KEY)
1-1871315-1

24POS(X-KEY)
1-1871315-2

26POS(X-KEY)
1-1871315-3

28POS(X-KEY)
1-1871315-4

THIS DRAWING IS A CONTROLLED DOCUMENT.		DWN T. KUDO 03DEC2020		
DIMENSIONS: mm		CHK D. MITSUGI 23AUG2005		
TOLERANCES UNLESS OTHERWISE SPECIFIED:		APVD D. MITSUGI 23AUG2005	NAME DYNAMIC D1100 SERIES HDR ASSY, V-TYPE, PRE-TIN 22~40POS	
0 PLC ±-		PRODUCT SPEC 108-78298	SIZE A3	
1 PLC ±0.5		APPLICATION SPEC 108-137366	CAGE CODE 00779	
2 PLC ±0.13		114-5377	DRAWING NO C=1871315	
3 PLC ±0.013		WEIGHT -	RESTRICTED TO -	
4 PLC ±0.0001		CUSTOMER DRAWING	SCALE 2:1	
ANGLES ±-			SHEET 2 OF 3	
FINISH -			REV D1	

SEE SHEET 1 OF 2

printed on 3 Feb 2021 16:39 (China Standard Time) from TE304429

4

3

2

1

THIS DRAWING IS UNPUBLISHED. RELEASED FOR PUBLICATION 20
© COPYRIGHT 2020 TE Connectivity. All Rights Reserved. ALL RIGHTS RESERVED.

LOC	DIST	REVISIONS					
		P	LTR	DESCRIPTION	DATE	DWN	APVD
-	-			SEE SHEET 1			

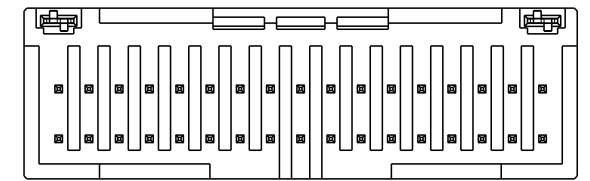
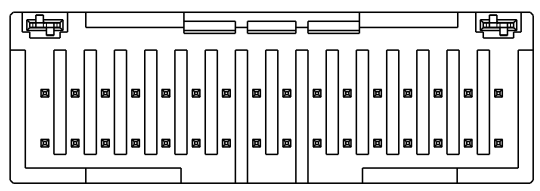
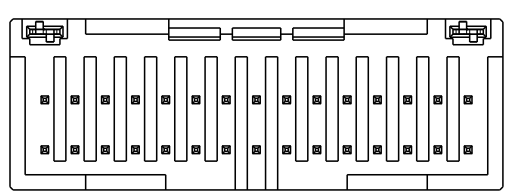
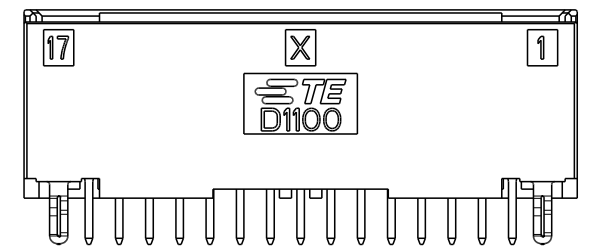
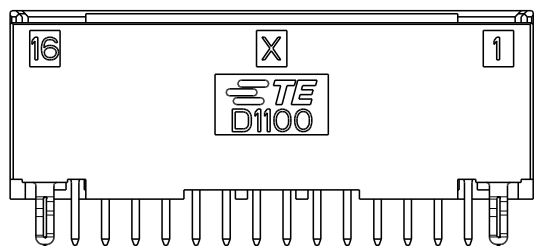
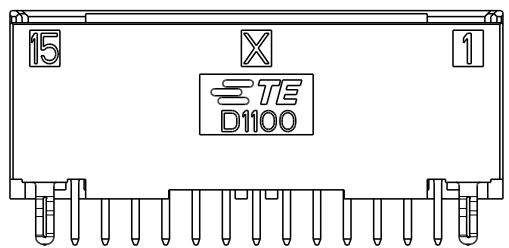
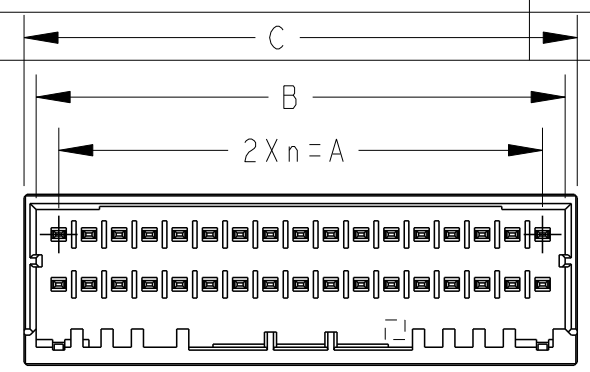
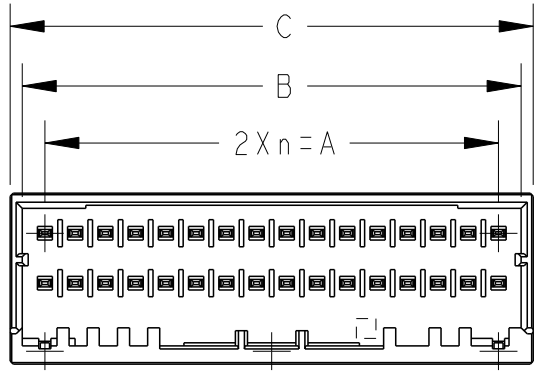
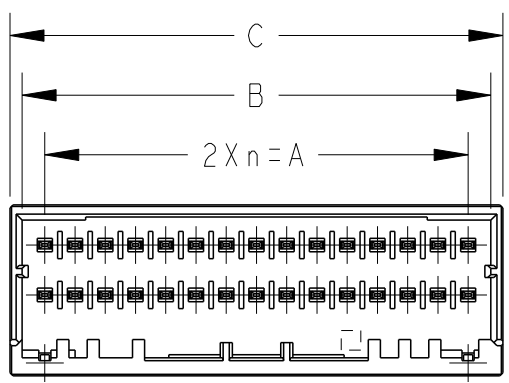

30POS(X-KEY)
1-1871315-5

32POS(X-KEY)
1-1871315-6

34POS(X-KEY)
1-1871315-7

NOTES: 2-1871315-7 IS SYMMETRY WITH 1-1871315-7 FOR KEY WAY

THIS DRAWING IS A CONTROLLED DOCUMENT.		DWN 03DEC2020 FISHER, ZHU	TE Connectivity	
DIMENSIONS: mm		CHK 03DEC2020 RICK, BIAN		
MATERIAL TBD		APVD 03DEC2020 RICK, BIAN	NAME DYNAMIC D1100 SERIES HDR ASSY, V-TYPE, PRE-TIN 22~40POS	
FINISH -		PRODUCT SPEC 108-78298 108-137366	SIZE A3	RESTRICTED TO -
TOLERANCES UNLESS OTHERWISE SPECIFIED: 0 PLC ±0.5 1 PLC ±0.13 2 PLC ±0.13 3 PEC ±0.013 4 PLC ±0.0001 ANGLES ±		APPLICATION SPEC 114-5377	CAGE CODE 00779	DRAWING NO C=1871315
CUSTOMER DRAWING		WEIGHT -	SCALE 2:1	SHEET 3 OF 3

printed on 3 Feb 2021 16:39 (China Standard Time) from TE304429

X-ON Electronics

Largest Supplier of Electrical and Electronic Components

Click to view similar products for [Headers & Wire Housings](#) category:

Click to view products by [TE Connectivity](#) manufacturer:

Other Similar products are found below :

[892-18-020-10-001101](#) [58102-G61-06LF](#) [582553-1](#) [0009485154](#) [009176003701906](#) [0050291907](#) [LY20-4P-DT1-P1E-BR](#) [02.125.8002.8](#)
[609-3404](#) [61062-3](#) [61082-181009](#) [622-3653LF](#) [63453-116](#) [636-1030](#) [636-1427](#) [636-3427](#) [636-4007](#) [641938-9](#) [641991-4](#) [644827-2](#) [65817-](#)
[010LF](#) [65817-015LF](#) [65863-015LF](#) [66207-023LF](#) [67095-007LF](#) [67601157](#) [68645-018](#) [68648-049](#) [70.362.1628.0](#) [70-4210](#) [70-4226B](#) [70-](#)
[4853B](#) [707-5020](#) [707-5028](#) [71.350.2428.0](#) [71918-208LF](#) [71961-016LF](#) [733-134](#) [733-162](#) [754199-000](#) [760-3052](#) [787-8014-00](#) [79531-3000](#)
[FCN-360C032-B](#) [FCN-367T-T012/H](#) [FCN-723D010/2](#) [80.063.4001.1](#) [800-90-001-10-001000](#) [800-90-010-10-002000](#) [801-43-002-10-013000](#)