

THIS DRAWING IS UNPUBLISHED. RELEASED FOR PUBLICATION 20  
 © COPYRIGHT 20 BY - ALL RIGHTS RESERVED.

LOC		DIST		REVISIONS			
P	LTR	DESCRIPTION	DATE	DWN	APVD		
	B2	REVISED PER ECR-18-006501	12OCT2018	WH	DZ		

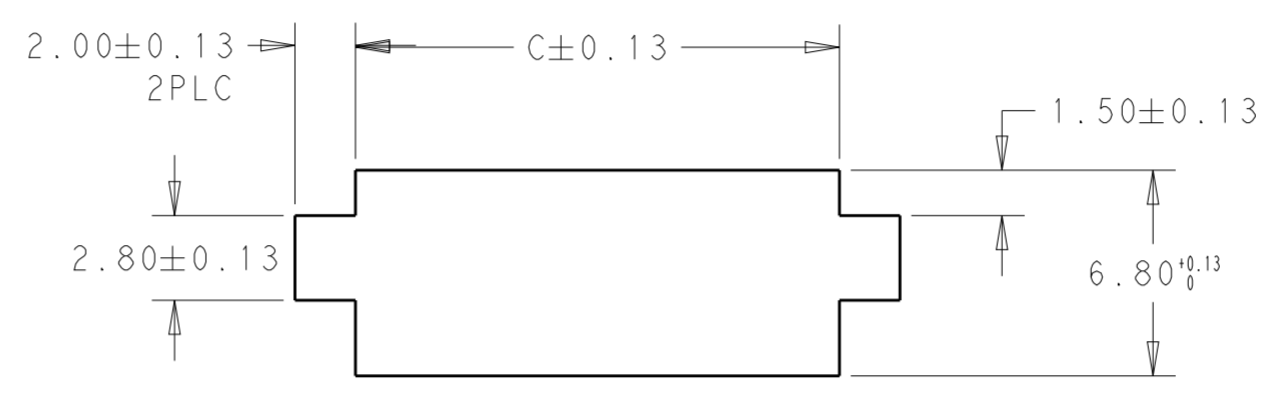

1. MATERIAL: NYLON UL94 - V0  
COLOR: NATURAL
2. ACCEPTS TE PIN CONTACTS  
P/N'S 2238007-(-)
3. HOUSING ACCEPTS OPTIONAL TPA  
P/N'S 1969443-(-)
4. MATES WITH TE PLUG HOUSINGS  
P/N'S 1969442-(-)
5. PRELIMINARY - NOT FOR PRODUCTION.

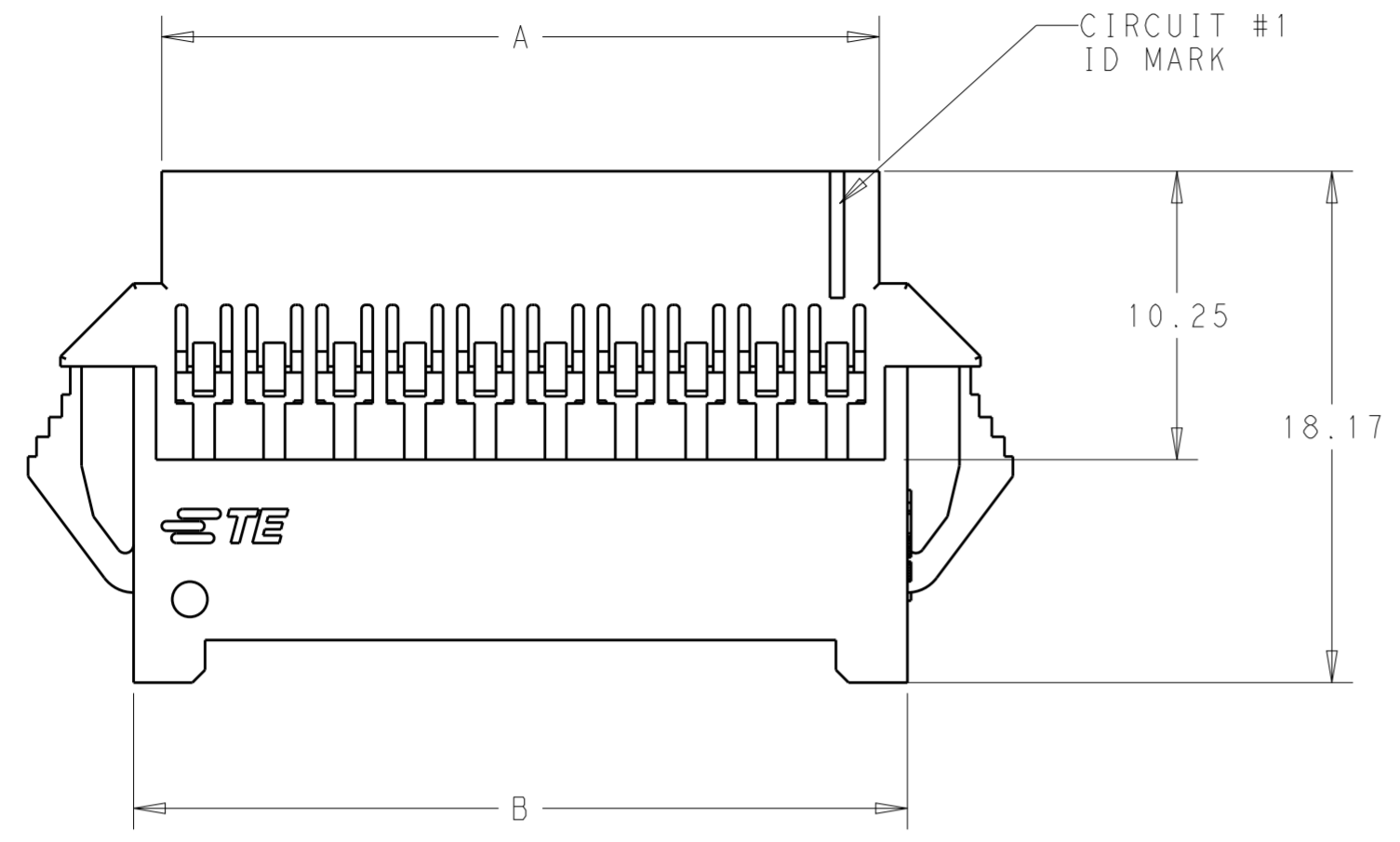
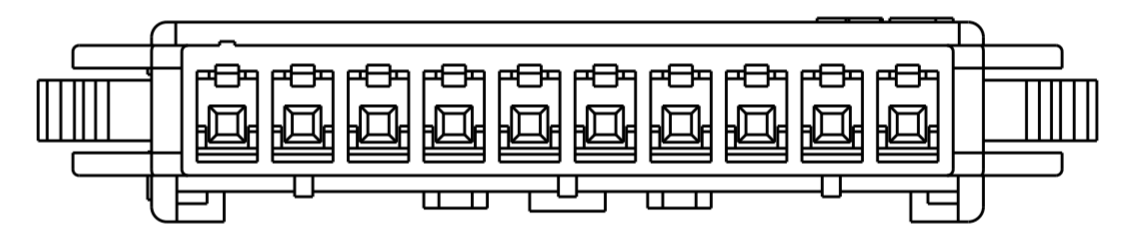
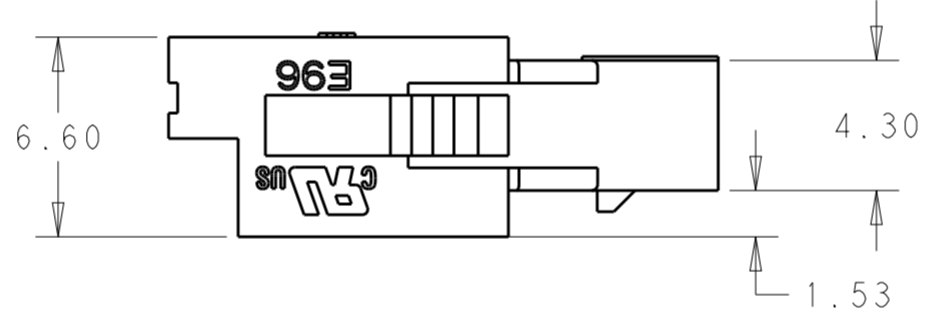
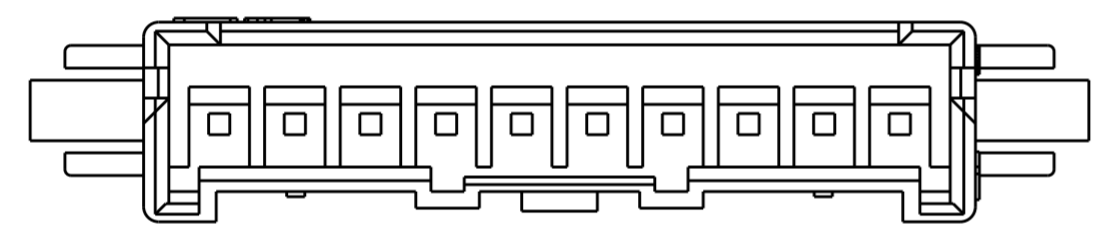

6 TO 15 POSITION  
1744501-6 TO 1-1744501-5

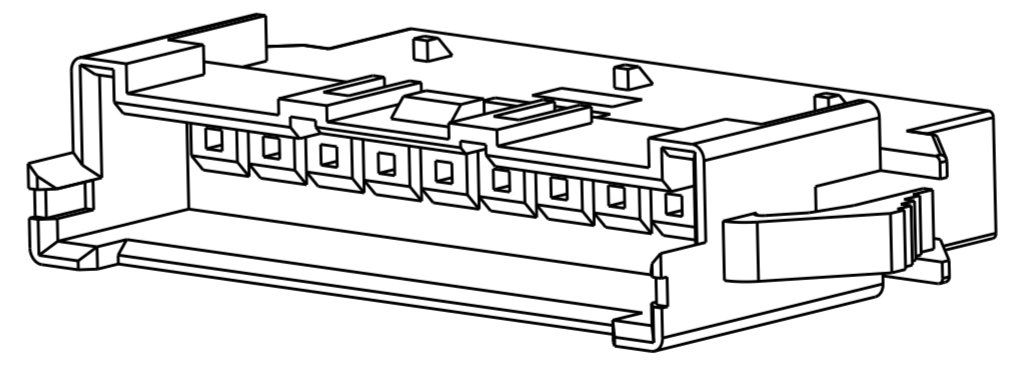
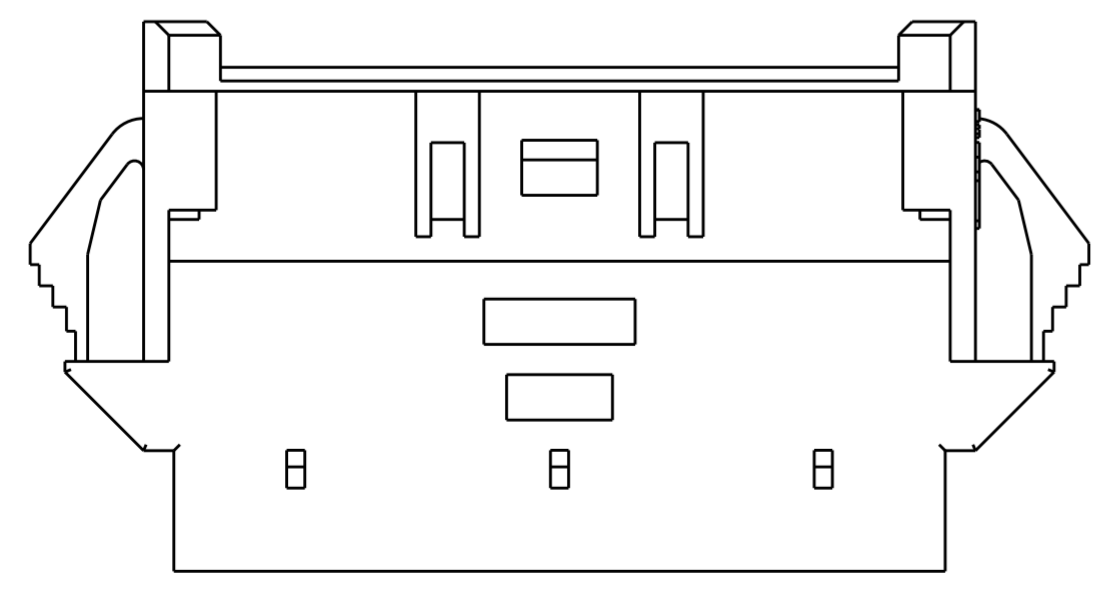

POS	DIM.C	DIM.B	DIM.A	PART NO. (BLANK)	PART NO. (NATURAL)
15	41.00	40.00	38.00	3-1969590-5	1-1969590-5
14	38.50	37.50	35.50	3-1969590-4	1-1969590-4
13	34.00	35.00	33.00	3-1969590-3	1-1969590-3
12	33.50	32.50	30.50	3-1969590-2	1-1969590-2
11	31.00	30.00	28.00	3-1969590-1	1-1969590-1
10	28.50	27.50	25.50	3-1969590-0	1-1969590-0
9	26.00	25.00	23.00	2-1969590-9	1969590-9
8	23.50	22.50	20.50	2-1969590-8	1969590-8
7	21.00	20.00	18.00	2-1969590-7	1969590-7
6	18.50	17.50	15.50	2-1969590-6	1969590-6
5	16.00	15.00	13.00	2-1969590-5	1969590-5
4	13.50	12.50	10.50	2-1969590-4	1969590-4
3	11.00	10.00	8.00	2-1969590-3	1969590-3
2	8.50	7.50	5.50	2-1969590-2	1969590-2

THIS DRAWING IS A CONTROLLED DOCUMENT.

DWN: A. NOEL 28SEP2012  
 CHK: K. RANDOLPH 01OCT2012  
 APVD: K. RANDOLPH 01OCT2012

**STE** TE Connectivity

NAME: ECONOMY POWER 2.5, HOUSING  
WIRE TO WIRE, WITH PANEL MOUNTS

PRODUCT SPEC: 108-2418  
 APPLICATION SPEC: 114-13315

SIZE: A2 CAGE CODE: 00779 DRAWING NO: C-1969590

RESTRICTED TO: -

Customer Drawing SCALE: N/A SHEET 1 OF 2 REV: B2

THIS DRAWING IS UNPUBLISHED. RELEASED FOR PUBLICATION 20  
 © COPYRIGHT 20 BY - ALL RIGHTS RESERVED.

LOC		DIST		REVISIONS			
P	LTR	DESCRIPTION	DATE	DWN	APVD		
-	-	SEE SHEET 1	-	-	-		

2 POSITION  
1969590-2

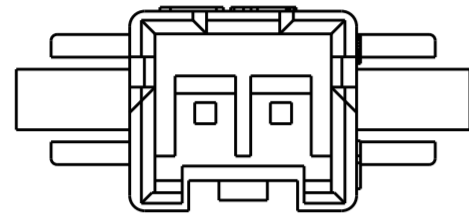

3 POSITION  
1969590-3

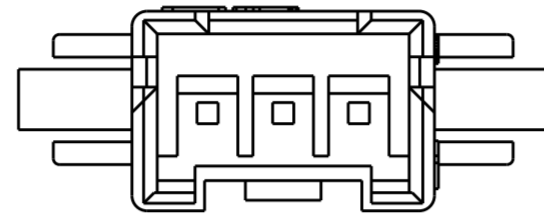

4 POSITION  
1969590-4

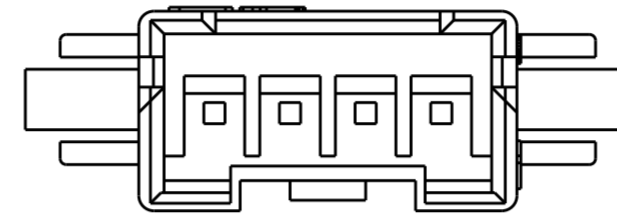

5 POSITION  
1969590-5

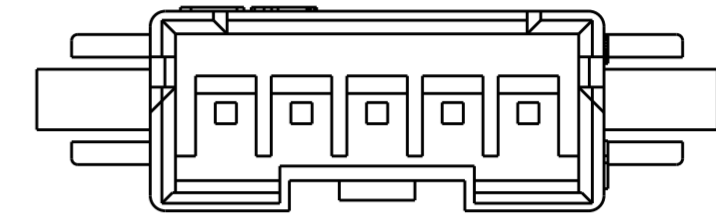

6-15 POSITION  
1969590-6 TO 1-1969590-5

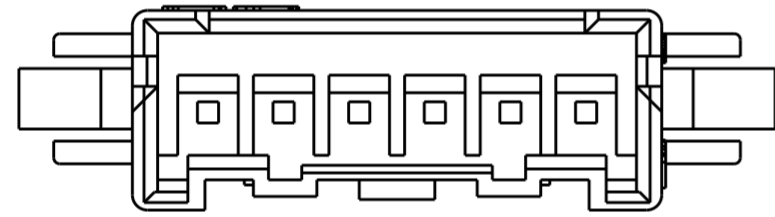

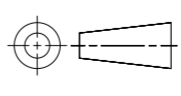
THIS DRAWING IS A CONTROLLED DOCUMENT.		DWN A. NOEL 28SEP2012	 TE Connectivity	
DIMENSIONS: mm		CHK K. RANDOLPH 01OCT2012		
TOLERANCES UNLESS OTHERWISE SPECIFIED:		APVD K. RANDOLPH 01OCT2012	NAME ECONOMY POWER 2.5, HOUSING WIRE TO WIRE, WITH PANEL MOUNTS	
		PRODUCT SPEC 108-2418	RESTRICTED TO -	
MATERIAL SEE TABLE		APPLICATION SPEC 114-13315	SIZE A200779	DRAWING NO C-1969590
FINISH SEE TABLE		WEIGHT -	SCALE N/A	SHEET 2 OF 2
		Customer Drawing	REV B2	

## X-ON Electronics

Largest Supplier of Electrical and Electronic Components

*Click to view similar products for [Headers & Wire Housings](#) category:*

*Click to view products by [TE Connectivity](#) manufacturer:*

Other Similar products are found below :

[95000-104TRLF](#) [10135584-644402LF](#) [DF62W-EP2022PCA](#) [95000-106TRLF](#) [DF62W-2022SCA](#) [DF62W-EP2022PC](#) [2203348](#) [DF62W-2022SC](#) [1084018](#) [1029039](#) [1084017](#) [802-10-012-10-002000](#) [1112640](#) [1112639](#) [000-34000](#) [0009482033](#) [0009507031](#) [57102-S06-03LF](#) [57202-S52-04LF](#) [PCN6-15S-2.5E](#) [0039019024](#) [58102-G61-06LF](#) [582553-1](#) [0009508121](#) [0050291907](#) [018731A](#) [LY20-4P-DT1-P1E-BR](#) [02.125.8002.8](#) [60101931](#) [60598-1 \(Cut Strip\)](#) [M1625-3R/100](#) [61062-3](#) [61082-181009](#) [636-1427](#) [638009-1](#) [641938-9](#) [641991-4](#) [644168-1](#) [647662-1](#) [65039-019ELF](#) [65817-002LF](#) [65817-015LF](#) [65863-015LF](#) [66207-023LF](#) [67016-026LF](#) [67046-001LF](#) [67095-007LF](#) [68002-116](#) [68016-236H](#) [68648-049](#)