

THIS DRAWING IS UNPUBLISHED. RELEASED FOR PUBLICATION 20  
 © COPYRIGHT 20 BY - ALL RIGHTS RESERVED.

REVISIONS							
LOC	DIST	P	LTR	DESCRIPTION	DATE	DWN	APVD
-	-	B3		REVISED PER ECR-21-101173	12APR2021	SS	WH

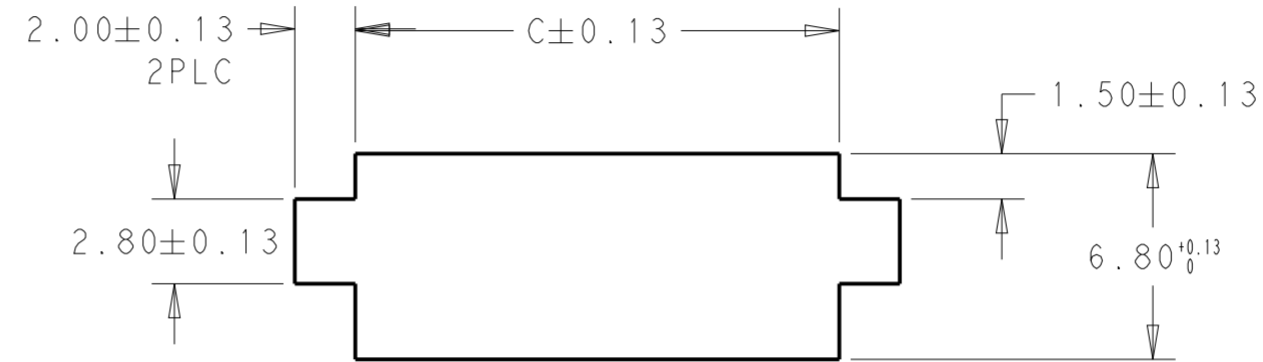

- 1 MATERIAL: NYLON UL94 - V0  
COLOR: NATURAL
- 2. ACCEPTS TE PIN CONTACTS  
P/N'S 2238007-(-)
- 3. HOUSING ACCEPTS OPTIONAL TPA  
P/N'S 1969443-(-)
- 4. MATES WITH TE PLUG HOUSINGS  
P/N'S 1969442-(-)
- 5 PRELIMINARY - NOT FOR PRODUCTION.

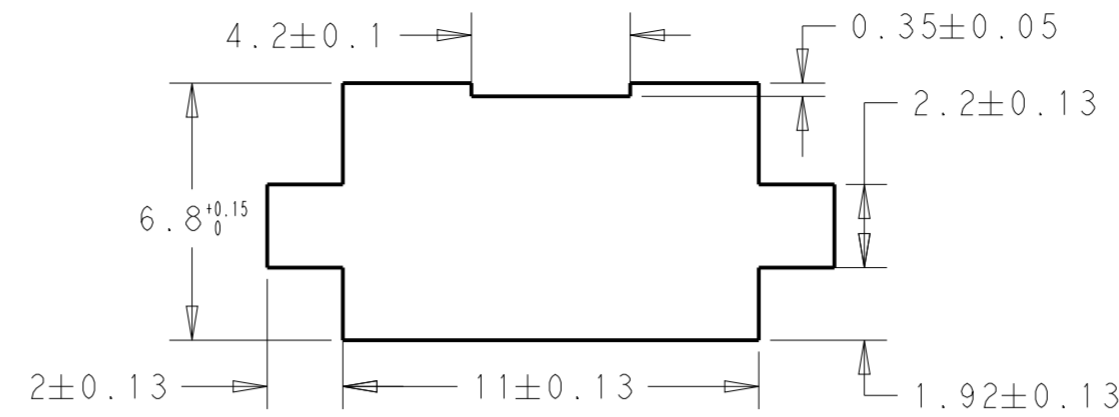
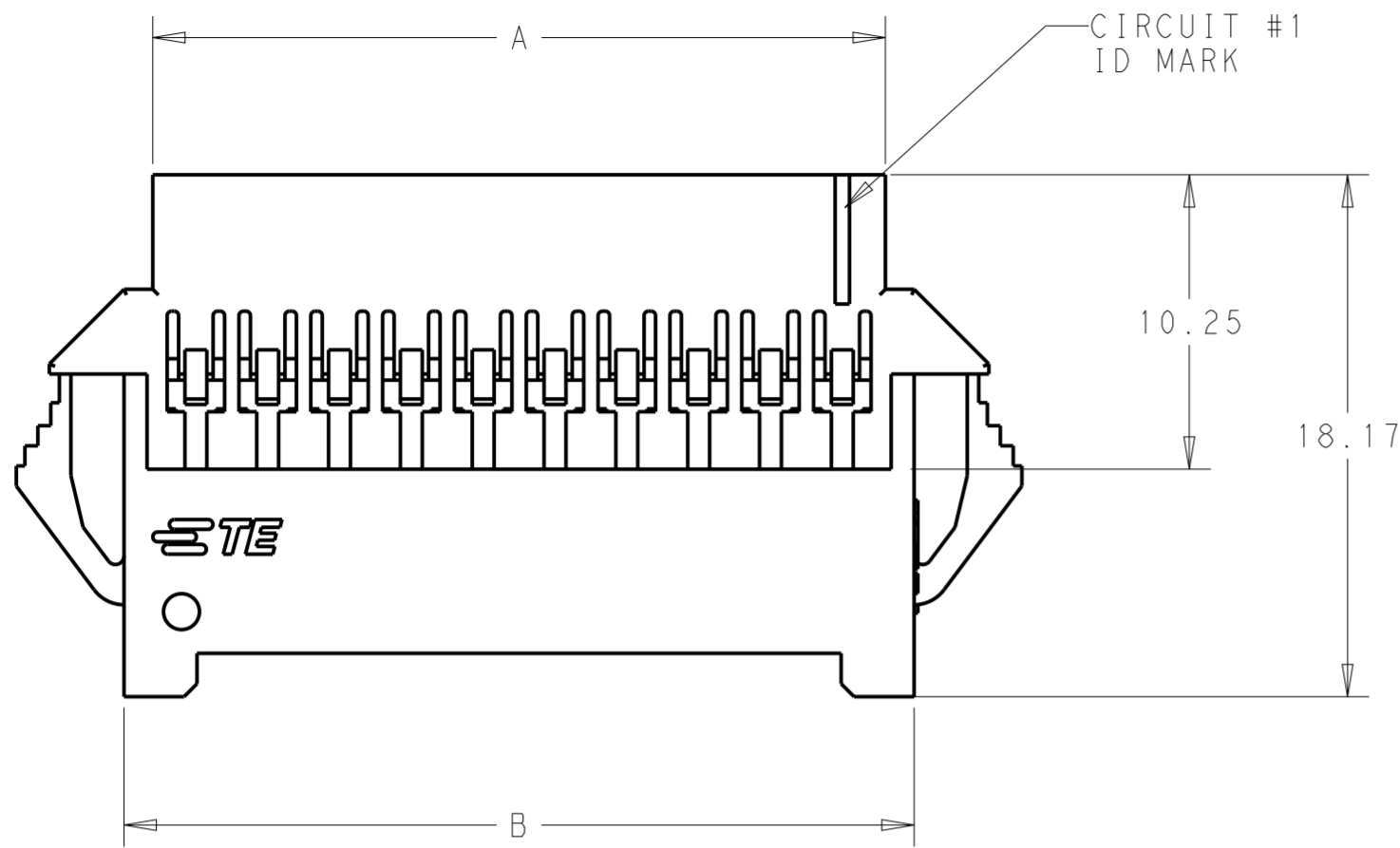
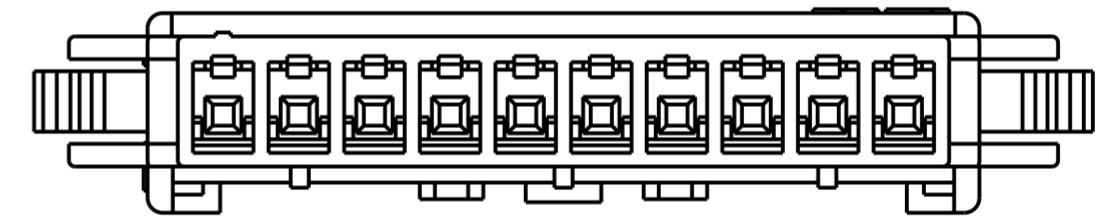
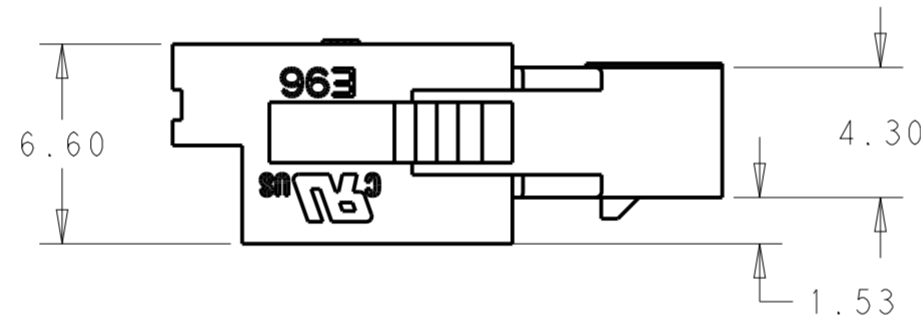
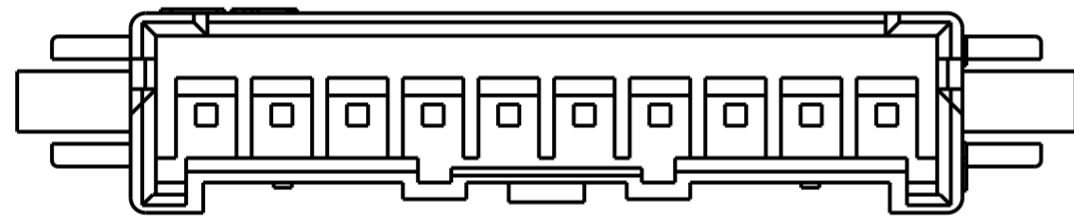

6 TO 15 POSITION  
 1744501-6 TO 1-1744501-5

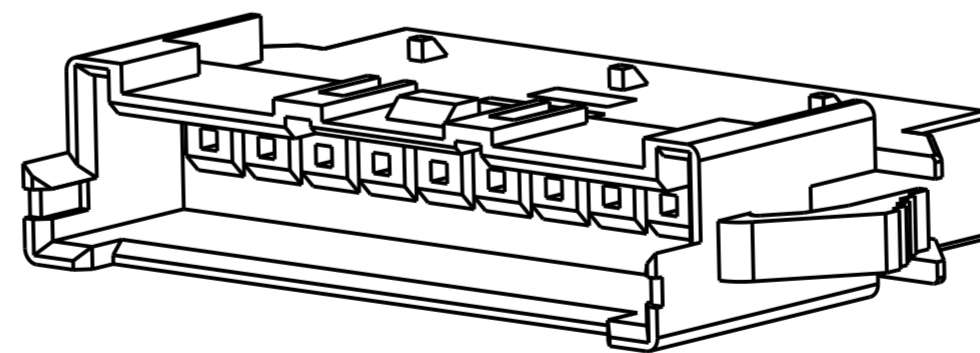
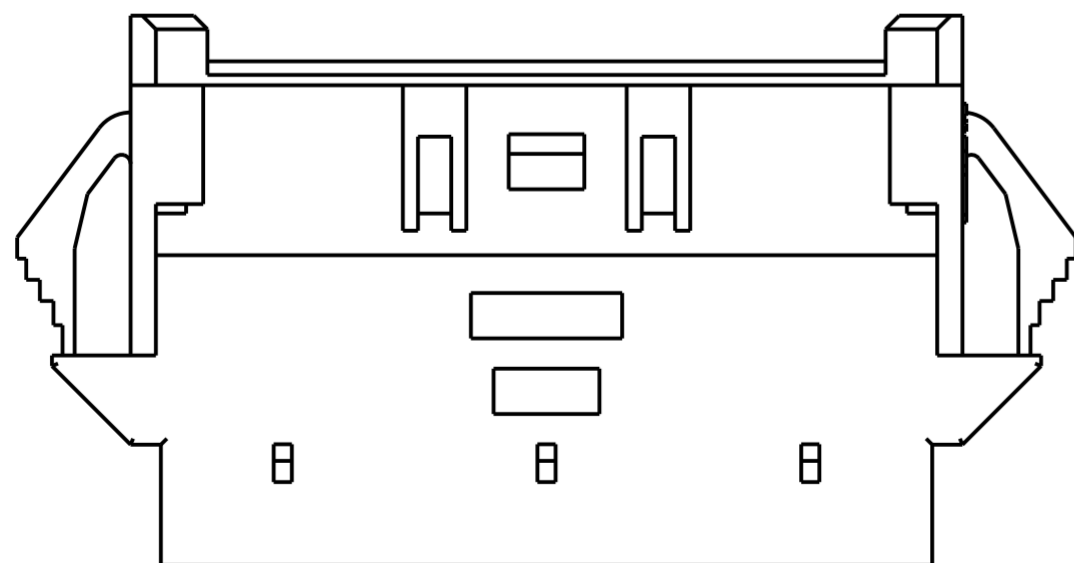

15	41.00	40.00	38.00	3-1969590-5	1-1969590-5
14	38.50	37.50	35.50	3-1969590-4	1-1969590-4
13	34.00	35.00	33.00	3-1969590-3	1-1969590-3
12	33.50	32.50	30.50	3-1969590-2	1-1969590-2
11	31.00	30.00	28.00	3-1969590-1	1-1969590-1
10	28.50	27.50	25.50	3-1969590-0	1-1969590-0
9	26.00	25.00	23.00	2-1969590-9	1969590-9
8	23.50	22.50	20.50	2-1969590-8	1969590-8
7	21.00	20.00	18.00	2-1969590-7	1969590-7
6	18.50	17.50	15.50	2-1969590-6	1969590-6
5	16.00	15.00	13.00	2-1969590-5	1969590-5
4	13.50	12.50	10.50	2-1969590-4	1969590-4
3	11.00	10.00	8.00	2-1969590-3	1969590-3
2	8.50	7.50	5.50	2-1969590-2	1969590-2
POS	DIM.C	DIM.B	DIM.A	PART NO. (BLANK)	PART NO. (NATURAL)

THIS DRAWING IS A CONTROLLED DOCUMENT.

DWN: A NOEL 28SEP2012  
 CHK: K RANDOLPH 01OCT2012  
 APVD: K RANDOLPH 01OCT2012

**STE** TE Connectivity

NAME: ECONOMY POWER 2.5, HOUSING WIRE TO WIRE, WITH PANEL MOUNTS

PRODUCT SPEC: 108-2418  
 APPLICATION SPEC: 114-13315

SIZE: A2 CAGE CODE: 00779 DRAWING NO: C-1969590

RESTRICTED TO: -

Customer Drawing SCALE: N/A SHEET 1 OF 2 REV: B3

THIS DRAWING IS UNPUBLISHED. RELEASED FOR PUBLICATION 20  
 © COPYRIGHT 20 BY - ALL RIGHTS RESERVED.

LOC		DIST		REVISIONS			
P	LTR	DESCRIPTION	DATE	DWN	APVD		
-	-	SEE SHEET 1	-	-	-		

2 POSITION  
1969590-2

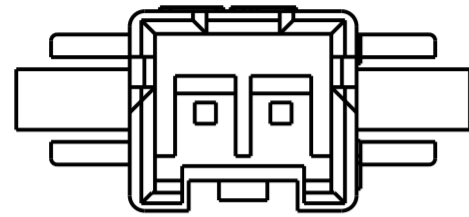

3 POSITION  
1969590-3

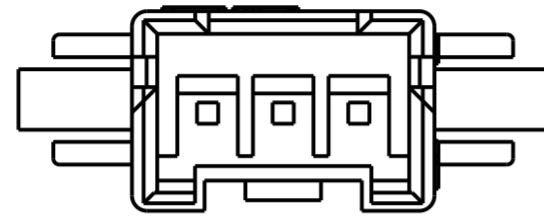

4 POSITION  
1969590-4

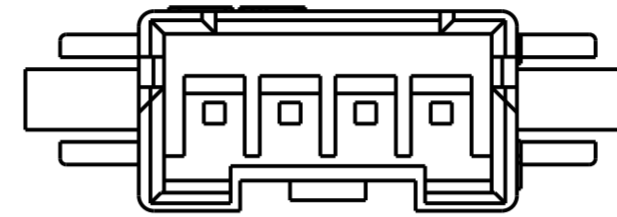

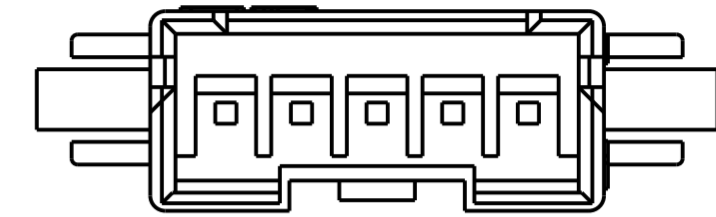

5 POSITION  
1969590-5

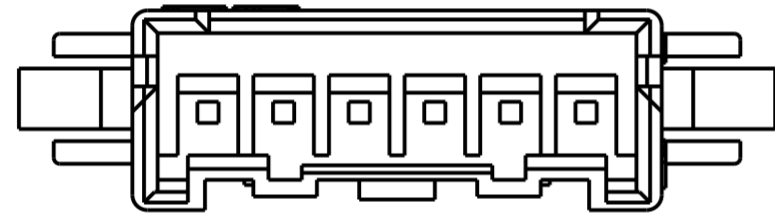

6-15 POSITION  
1969590-6 TO 1-1969590-5

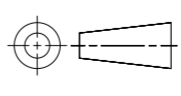

THIS DRAWING IS A CONTROLLED DOCUMENT.		DWN A. NOEL 28SEP2012	 TE Connectivity	
DIMENSIONS: mm 		CHK K. RANDOLPH 01OCT2012		
TOLERANCES UNLESS OTHERWISE SPECIFIED: 0 PLC ±- 1 PLC ±- 2 PLC ±0.20 3 PLC ±- 4 PLC ±- ANGLES ±- FINISH		APVD K. RANDOLPH 01OCT2012	NAME ECONOMY POWER 2.5, HOUSING WIRE TO WIRE, WITH PANEL MOUNTS	
MATERIAL 		PRODUCT SPEC 108-2418	SIZE A200779	DRAWING NO C-1969590
		APPLICATION SPEC 114-13315	RESTRICTED TO -	
		WEIGHT -	SCALE N/A	SHEET 2 OF 2
		Customer Drawing	REV B3	

## X-ON Electronics

Largest Supplier of Electrical and Electronic Components

*Click to view similar products for [Headers & Wire Housings](#) category:*

*Click to view products by [TE Connectivity](#) manufacturer:*

Other Similar products are found below :

[892-18-020-10-001101](#) [58102-G61-06LF](#) [582553-1](#) [0009485154](#) [009176003701906](#) [0050291907](#) [LY20-4P-DT1-P1E-BR](#) [02.125.8002.8](#)  
[609-3404](#) [61062-3](#) [61082-181009](#) [622-3653LF](#) [63453-116](#) [636-1030](#) [636-1427](#) [636-3427](#) [636-4007](#) [641938-9](#) [641991-4](#) [644827-2](#) [65817-](#)  
[010LF](#) [65817-015LF](#) [65863-015LF](#) [66207-023LF](#) [67095-007LF](#) [67601157](#) [68645-018](#) [68648-049](#) [70.362.1628.0](#) [70-4210](#) [70-4226B](#) [70-](#)  
[4853B](#) [707-5020](#) [707-5028](#) [71.350.2428.0](#) [71918-208LF](#) [71961-016LF](#) [733-134](#) [733-162](#) [754199-000](#) [760-3052](#) [787-8014-00](#) [79531-3000](#)  
[FCN-360C032-B](#) [FCN-367T-T012/H](#) [FCN-723D010/2](#) [80.063.4001.1](#) [800-90-001-10-001000](#) [800-90-010-10-002000](#) [801-43-002-10-013000](#)