

THIS DRAWING IS UNPUBLISHED. RELEASED FOR PUBLICATION
 © COPYRIGHT - TE Connectivity ALL RIGHTS RESERVED.

REVISIONS				
P	LTR	DESCRIPTION	DATE	APVD
E2		ECR-18-002718	23FEB2018	M.G D.Z

(2 POS.)

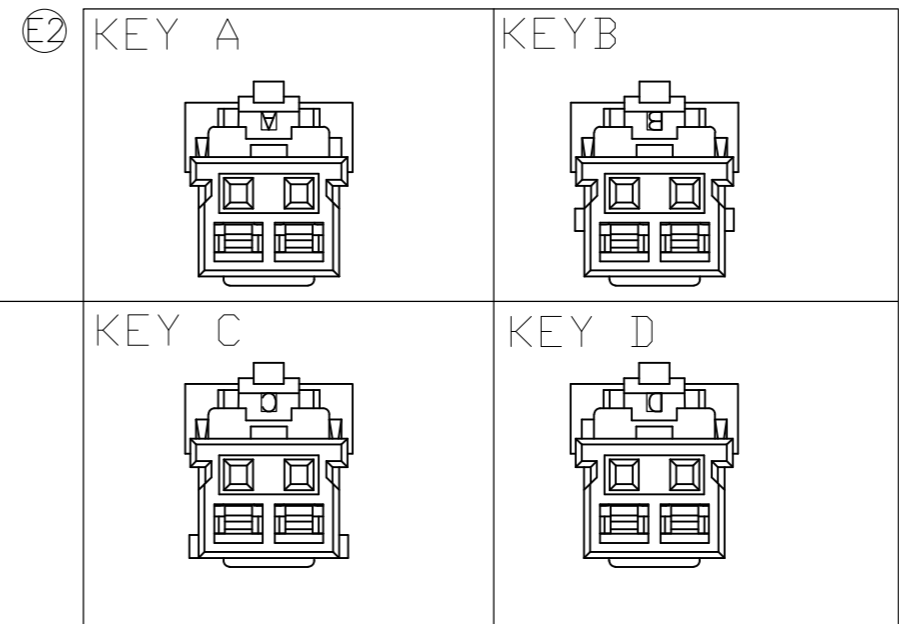
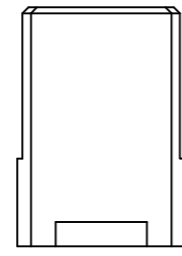

NOTE:
 1. GENERAL TOLERANCE: $\pm 0.3, \pm 3^\circ$
 2. MATERIAL: 66NYLON GF(UL94V-0)
 3. MATING CONN. P/N: SEE TABLE
 4. APPLICABLE CONTACT P/N:
 1971031-1

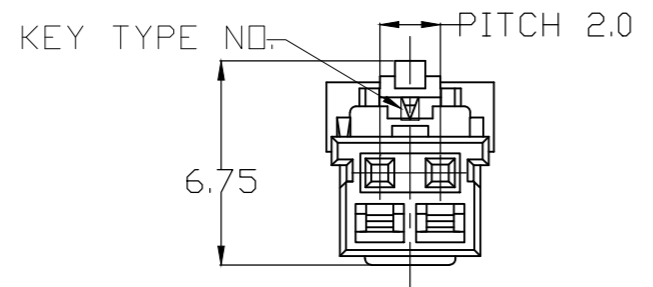
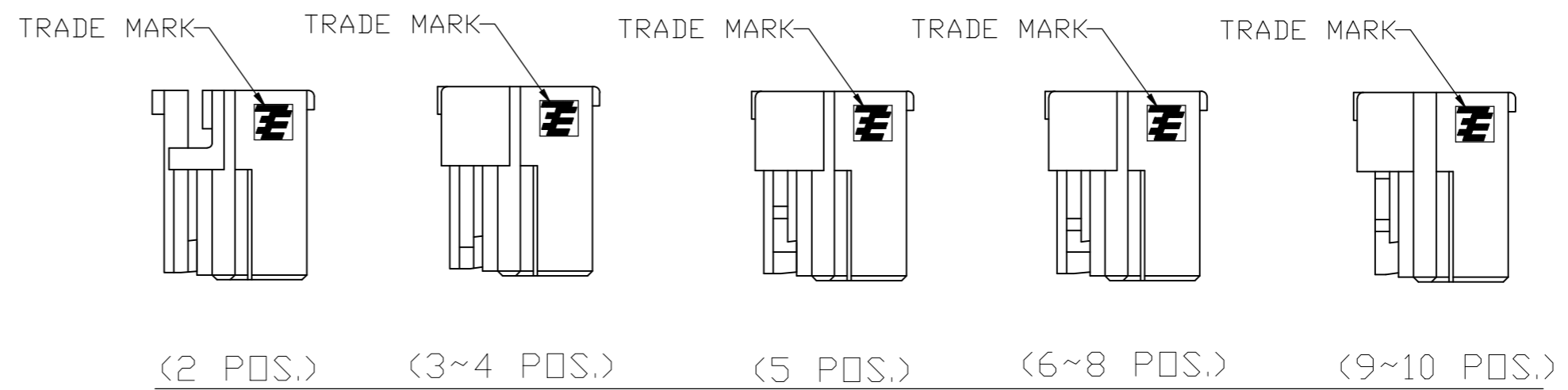
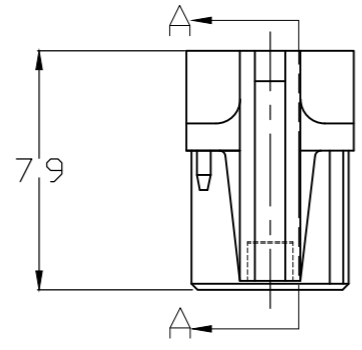
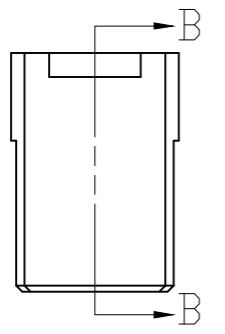
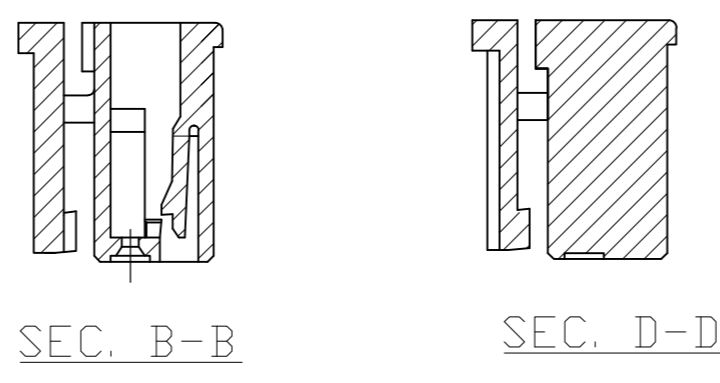
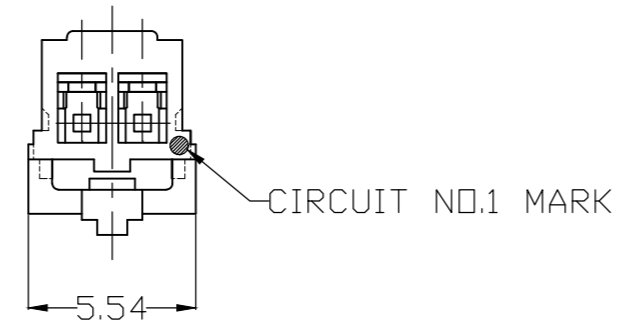

THIS DRAWING IS A CONTROLLED DOCUMENT.		DWN Liu Jimmy 11JUN2008														
DIMENSIONS: mm		CHK Wu hapye 11JUN2008														
TOLERANCES UNLESS OTHERWISE SPECIFIED:		APVD Zhou Julian 11JUN2008	NAME Grace Inertia Connector 2.0 EV Series Plug Housing													
<table border="1"> <tr><td>0 PLC</td><td>±</td></tr> <tr><td>1 PLC</td><td>±</td></tr> <tr><td>2 PLC</td><td>±</td></tr> <tr><td>3 PLC</td><td>±</td></tr> <tr><td>4 PLC</td><td>±</td></tr> <tr><td>ANGLES</td><td>±</td></tr> </table>		0 PLC	±	1 PLC	±	2 PLC	±	3 PLC	±	4 PLC	±	ANGLES	±	PRODUCT SPEC 108-106001	SIZE A2	CAGE CODE 00779
0 PLC	±															
1 PLC	±															
2 PLC	±															
3 PLC	±															
4 PLC	±															
ANGLES	±															
MATERIAL SEE NOTE		FINISH -	APPLICATION SPEC 114-5425	DRAWING NO. C=1971030												
		WEIGHT 0	RESTRICTED TO -													
		CUSTOMER DRAWING	SCALE 4:1	SHEET 1 of 3												
			REV E2													

THIS DRAWING IS UNPUBLISHED. RELEASED FOR PUBLICATION
 © COPYRIGHT - TE Connectivity ALL RIGHTS RESERVED.

REVISIONS				
P	LTR	DESCRIPTION	DATE	APVD
-	-	SEE SHEET 1	-	-

(3 POS.)

(4 POS.)

(5 POS.)

(6 POS.)

(7 POS.)

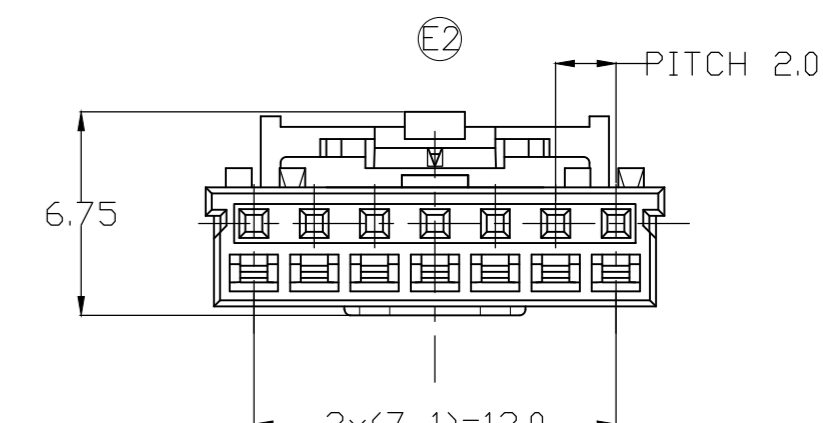
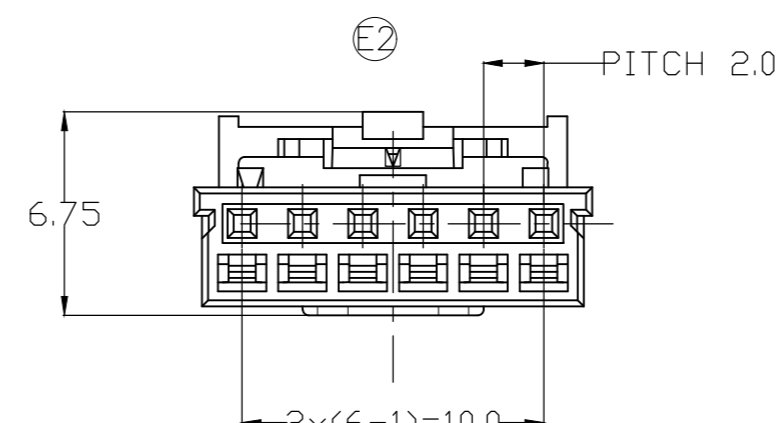
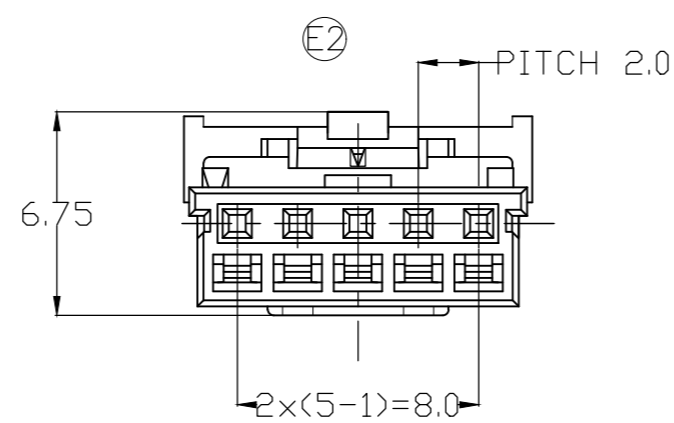
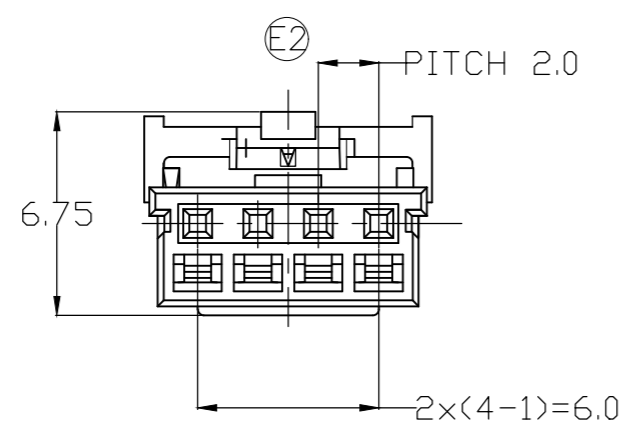
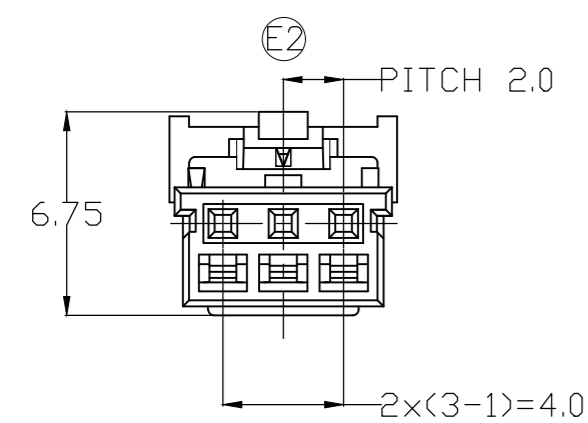
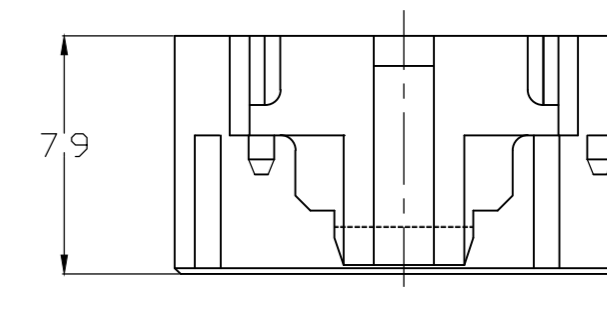
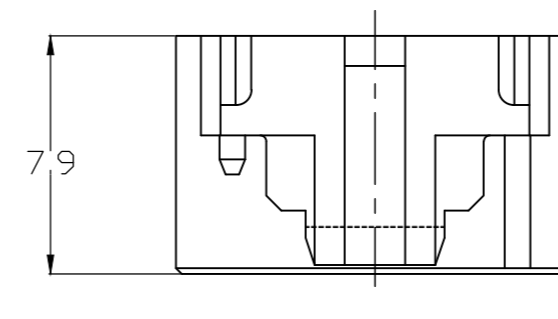
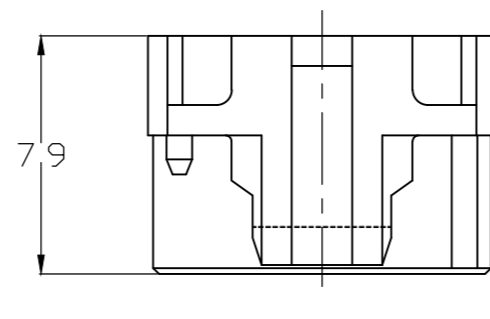
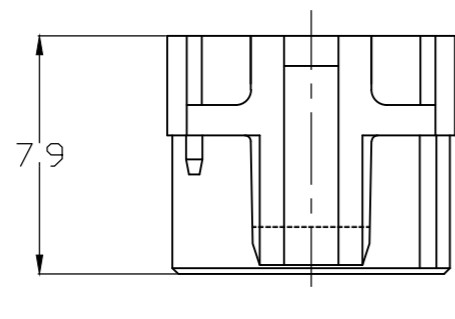
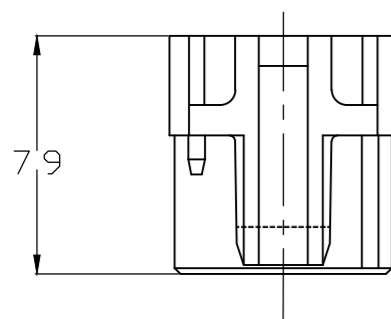
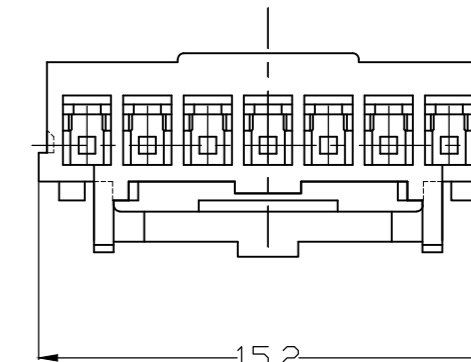
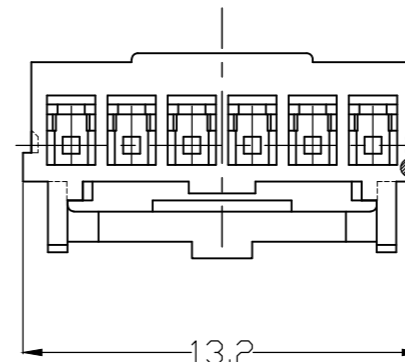
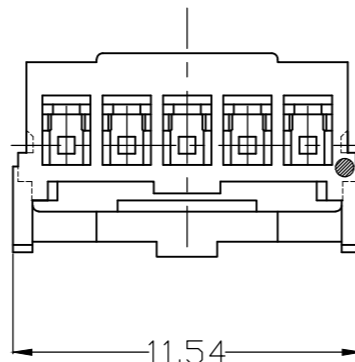
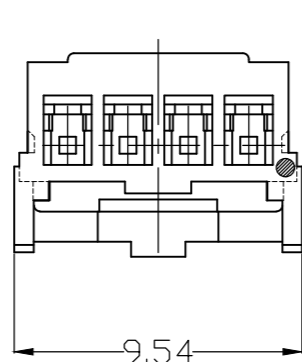
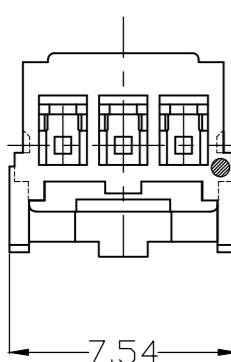
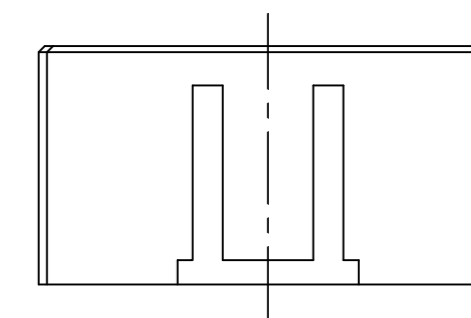
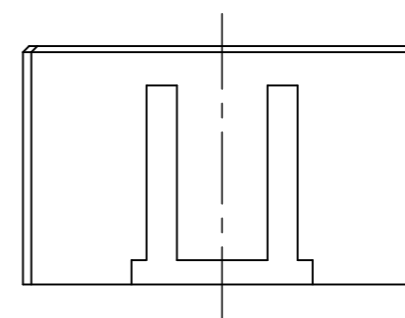
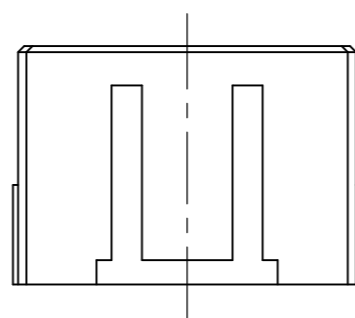
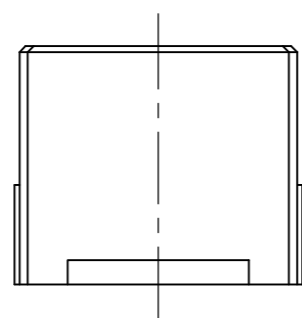
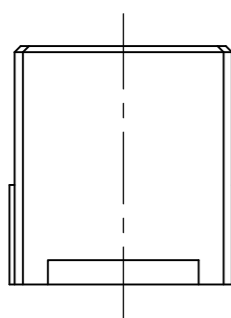

THIS DRAWING IS A CONTROLLED DOCUMENT.		DWN Liu Jimmy 11JUN2008	TE Connectivity		
DIMENSIONS: mm		CHK Wu Hapye 11JUN2008			
		APVD Zhou Julian 11JUN2008	NAME Grace Inertia Connector 2.0 EV Series Plug Housing		
TOLERANCES UNLESS OTHERWISE SPECIFIED: 0 PLC ± 1 PLC ± 2 PLC ± 3 PLC ± 4 PLC ± ANGLES ±		PRODUCT SPEC 108-106001	SIZE A2	CAGE CODE 00779	DRAWING NO. C-1971030
MATERIAL -		FINISH -	WEIGHT -	RESTRICTED TO -	
CUSTOMER DRAWING			SCALE 4:1	SHEET 2 of 3	REV E2

THIS DRAWING IS UNPUBLISHED. RELEASED FOR PUBLICATION
 © COPYRIGHT - TE Connectivity ALL RIGHTS RESERVED.

REVISIONS					
P	LTR	DESCRIPTION	DATE	DWN	APVD
-	-	SEE SHEET 1	-	-	-

(8 POS.)

(9 POS.)

(10 POS.)

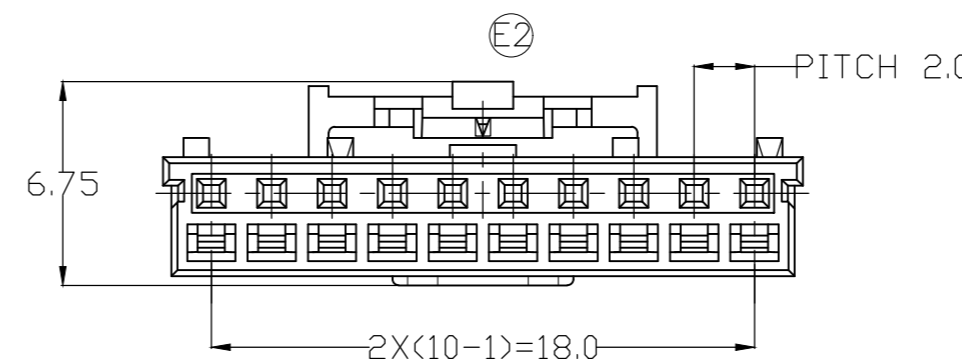
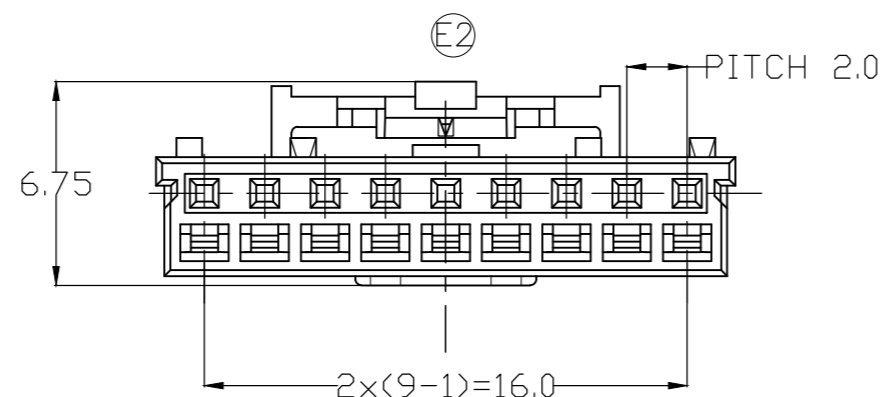
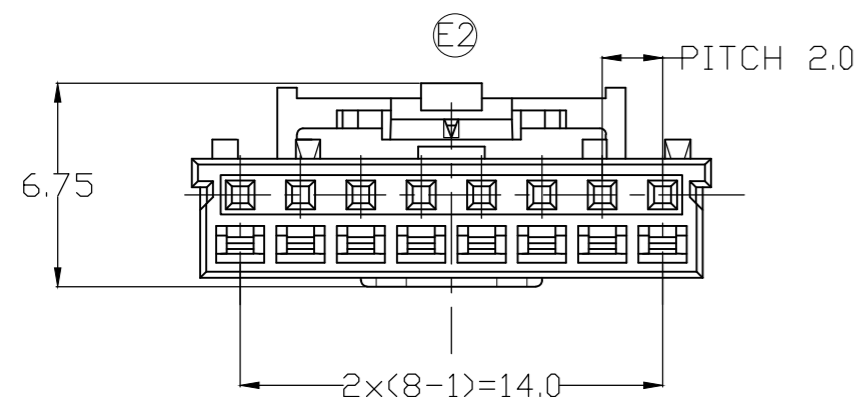
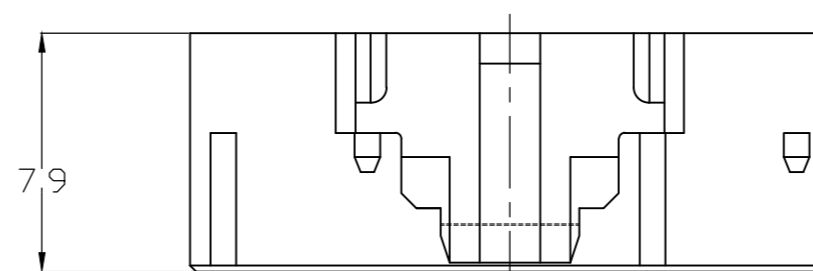
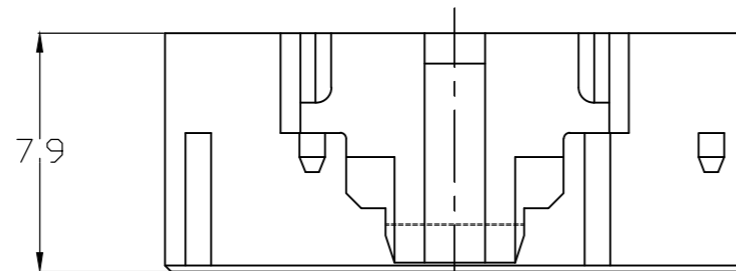
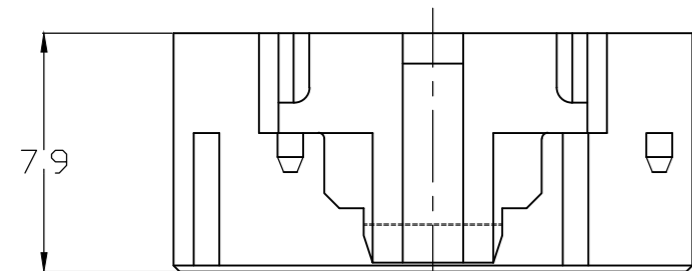
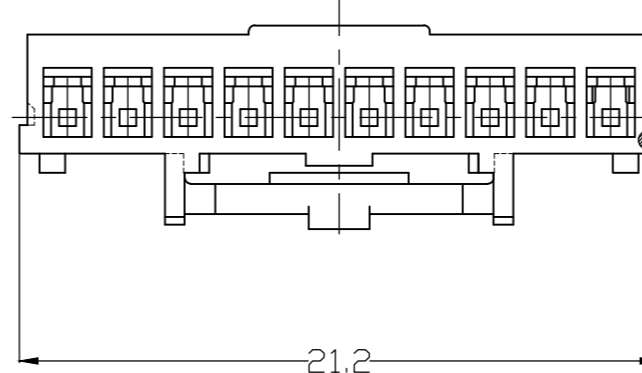
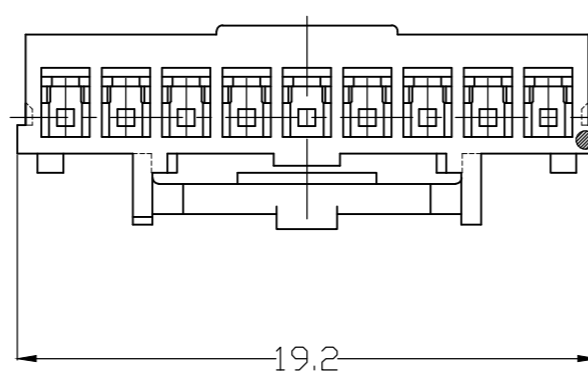
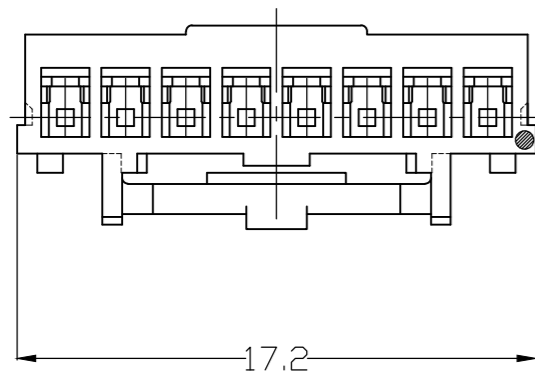
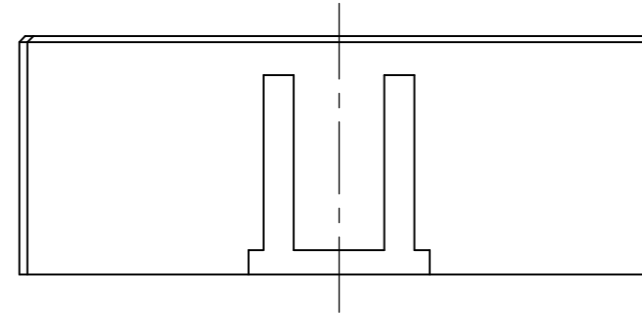
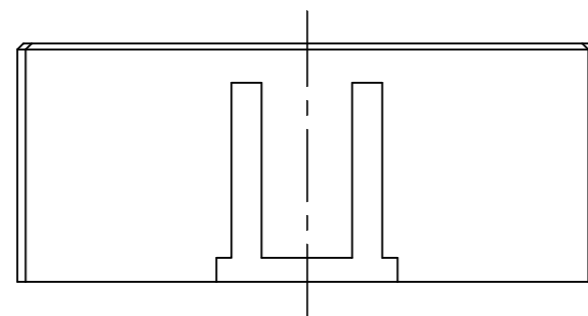
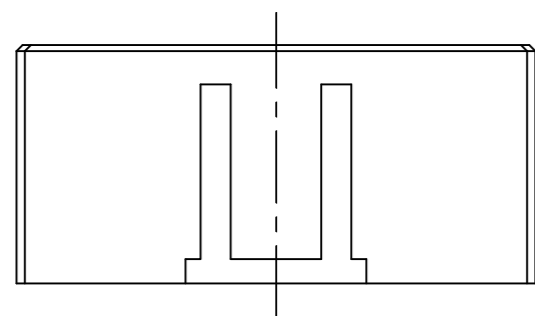

KEY TYPE	COLOR	POS.	PART NUMBER	
3-1971032-1	D	YELLOW	3-1971030-1	
2-1971032-1	C	BLUE	2-1971030-1	
1-1971032-1	B	RED	1-1971030-1	
1971032-1	A	NATURAL	1971030-1	
3-1971032-9	D	YELLOW	3-1971030-9	
2-1971032-9	C	BLUE	2-1971030-9	
1-1971032-9	B	RED	1-1971030-9	
1971032-9	A	NATURAL	1971030-9	
3-1971032-8	D	YELLOW	3-1971030-8	
2-1971032-8	C	BLUE	2-1971030-8	
1-1971032-8	B	RED	1-1971030-8	
1971032-8	A	NATURAL	1971030-8	
3-1971032-7	D	YELLOW	3-1971030-7	
2-1971032-7	C	BLUE	2-1971030-7	
1-1971032-7	B	RED	1-1971030-7	
1971032-7	A	NATURAL	1971030-7	
3-1971032-6	D	YELLOW	3-1971030-6	
2-1971032-6	C	BLUE	2-1971030-6	
1-1971032-6	B	RED	1-1971030-6	
1971032-6	A	NATURAL	1971030-6	
4-1971032-5	E	BLACK	4-1971030-5	
3-1971032-5	D	YELLOW	3-1971030-5	
2-1971032-5	C	BLUE	2-1971030-5	
1-1971032-5	B	RED	1-1971030-5	
1971032-5	A	NATURAL	1971030-5	
3-1971032-4	D	YELLOW	3-1971030-4	
2-1971032-4	C	BLUE	2-1971030-4	
1-1971032-4	B	RED	1-1971030-4	
1971032-4	A	NATURAL	1971030-4	
3-1971032-3	D	YELLOW	3-1971030-3	
2-1971032-3	C	BLUE	2-1971030-3	
1-1971032-3	B	RED	1-1971030-3	
1971032-3	A	NATURAL	1971030-3	
4-1971032-2	E	BLACK	4-1971030-2	
3-1971032-2	D	YELLOW	3-1971030-2	
2-1971032-2	C	BLUE	2-1971030-2	
1-1971032-2	B	RED	1-1971030-2	
1971032-2	A	NATURAL	1971030-2	
MATING CONNECTOR PART NUMBER	KEY TYPE	COLOR	POS.	PART NUMBER

THIS DRAWING IS A CONTROLLED DOCUMENT.

DWN Liu Jimmy 11JUN2008
 CHK Wu Sam 11JUN2008
 APVD Zhou Julian 11JUN2008

TE Connectivity

Grace Inertia Connector 2.0 EV Series Plug Housing

108-106001

114-5425

SIZE A2 CAGE CODE 00779 DRAWING NO. C-1971030

WEIGHT - RESTRICTED TO -

CUSTOMER DRAWING SCALE 4:1 SHEET 3 of 3 REV E2

X-ON Electronics

Largest Supplier of Electrical and Electronic Components

Click to view similar products for [Headers & Wire Housings](#) category:

Click to view products by [TE Connectivity](#) manufacturer:

Other Similar products are found below :

[57102-F02-18ULF](#) [58102-G61-06LF](#) [0009485154](#) [009176003701906](#) [0050291907](#) [00-9021-0611-00-339](#) [02.125.8002.8](#) [609-3404](#) [61062-3](#)
[622-0430](#) [622-3653LF](#) [63453-116](#) [636-1030](#) [636-1427](#) [636-3427](#) [636-4007](#) [641938-9](#) [644827-2](#) [65495-038](#) [65692-001LF](#) [65781-018](#)
[65781-047](#) [65817-010LF](#) [65817-015LF](#) [66207-023LF](#) [67016-026LF](#) [67095-007LF](#) [68631-112](#) [68645-018](#) [68648-049](#) [699319-000](#)
[70.362.1628.0](#) [70-4210](#) [70-4226B](#) [70-4853B](#) [707-5020](#) [707-5028](#) [71.350.2428.0](#) [71961-016LF](#) [733-134](#) [754199-000](#) [760-3052](#) [787-8014-00](#)
[FCN-367T-T012/H](#) [80.063.4001.1](#) [800-90-001-10-001000](#) [800-90-010-10-002000](#) [801-43-002-10-013000](#) [801-43-006-10-002000](#)
[803-41-018-10-001000](#)