

THIS DRAWING IS UNPUBLISHED. RELEASED FOR PUBLICATION 20
 © COPYRIGHT 20 BY - ALL RIGHTS RESERVED.

LOC		DIST		REVISIONS			
P	LTR	DESCRIPTION		DATE	DWN	APVD	
ES	00	A18	ECR-21-100790	04MAR2021	PJ	FL	

- NOTE**
- SEE SHEET 4 FOR AVAILABLE CONFIGURATIONS
 - MATERIAL: HOUSING, NYLON, UL94 V0, 750°C GWT NO FLAME
 EIGHT COLORS AVAILABLE, INCLUDING: NATURAL, RED, BLUE, YELLOW, BLACK, GREY, GREEN, PURPLE
 WHITE VERSION IS PRELIMINARY
 FOR 1-2367449-1, THE HOUSING IS PA66 WITH HIGHER THERMAL RESISTANCE
 CONTACT, COPPER ALLOY, 0.60MM THICK
 - FINISH: OPTION 1: TIN PLATING OVER NICKEL UNDERPLATING
 OPTION 2: AG PLATING OVER NICKEL UNDERPLATING
 - PCB LAYOUT AS SHOWN
 - △ THE PART NUMBERS SHOWING IN SHEET 2 & 3 & 4 ARE FOR NATURAL COLOR. THE PART NUMBER FOR OTHER COLOR ARE BASED ON THE NATURAL ONE: FOR THE SAME CONFIGURATION, THE PREFIX AND POSTFIX OF THE P/N ARE THE SAME, ONLY THE BASE NUMBER IS DIFFERENT ACCORDING TO DIFFERENT COLOR, DETAIL PLEASE SEE SHEET 6
 - △ PACKAGING: LOOSE PIECE OR TUBE. THE PART NUMBERS IN THIS DRAWING ARE WITH LOOSE PIECE PACKAGING EXCEPT THE PN 1-2322471-3. PLEASE CONTACT TE SALES REPRESENTATIVES FOR TUBE PACKAGING REQUIREMENT.
 - △ FOR PN 7-1971817-5 PIN LAYOUT AS FOLLOW
 - △ PRELIMINARY PART NOT RELEASED FOR PRODUCTION
 - △ SPECIAL VERSION WITHOUT PEG FEATURE.

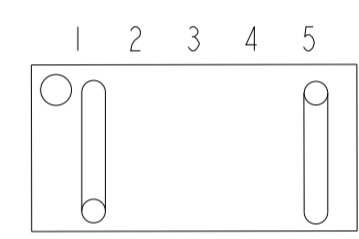

△ PN 5-1971817-5: PCB LAYOUT FOR ODD NUMBERS OF PINS APPLIES (THE POSITION OF THE PINS 1 AND 5 ARE SAME AS 1-1971817-5).

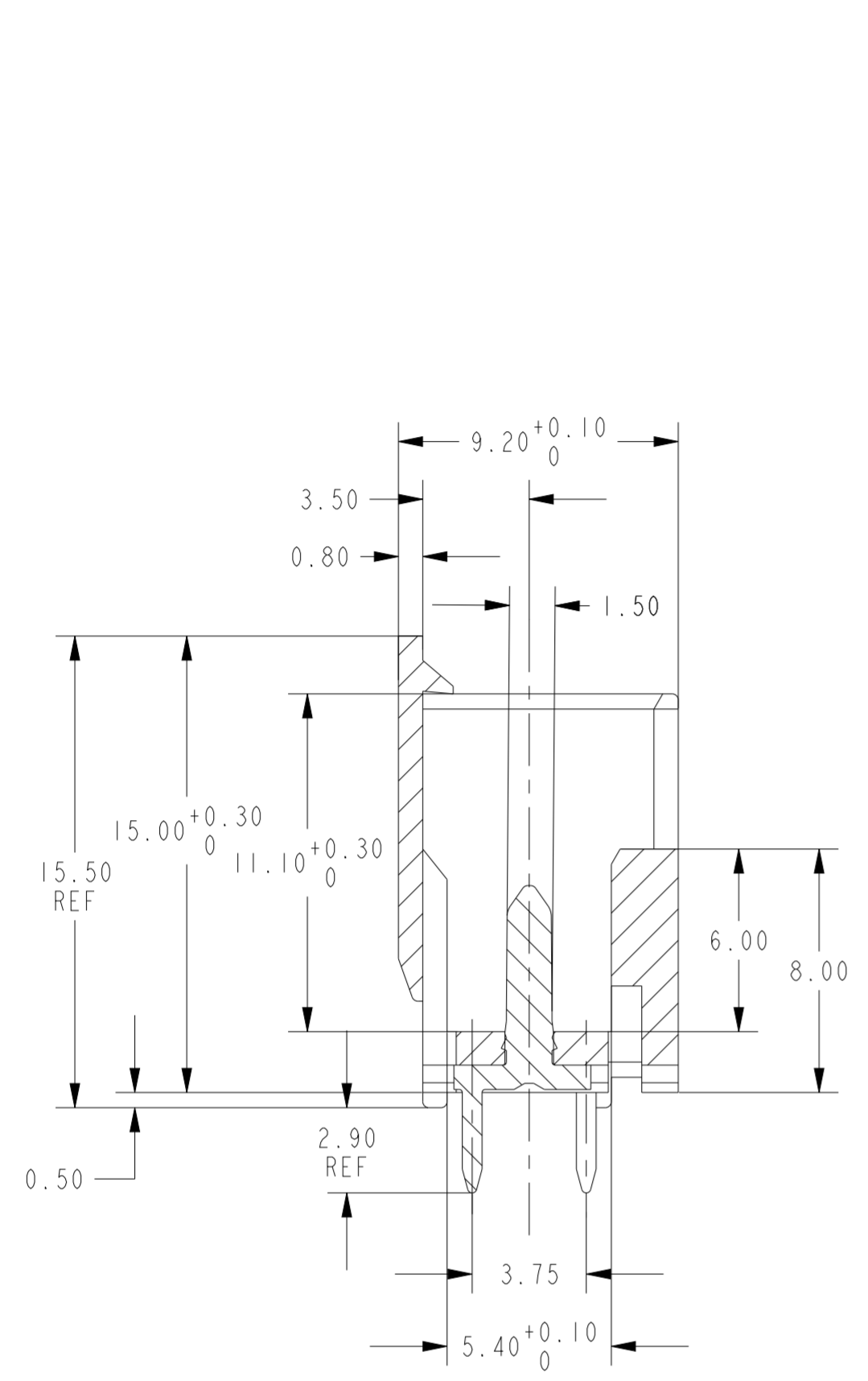

SECTION A-A

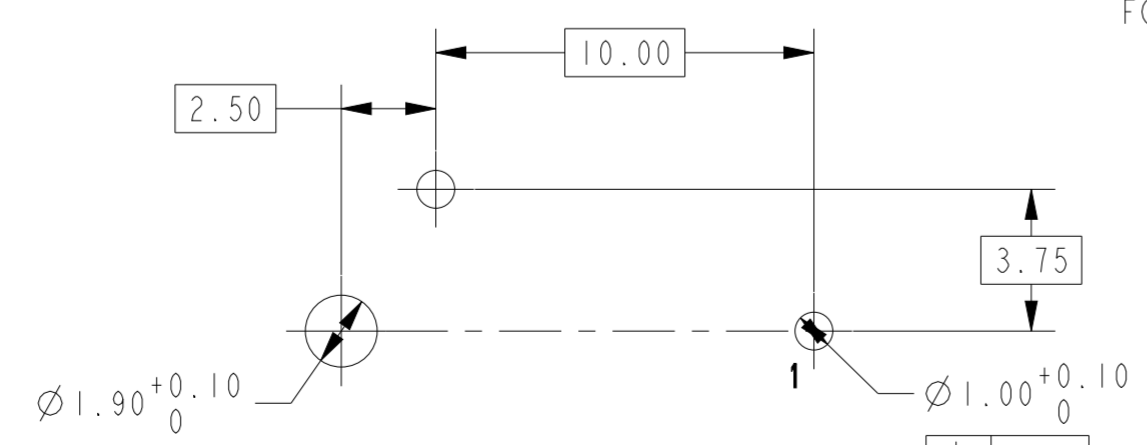
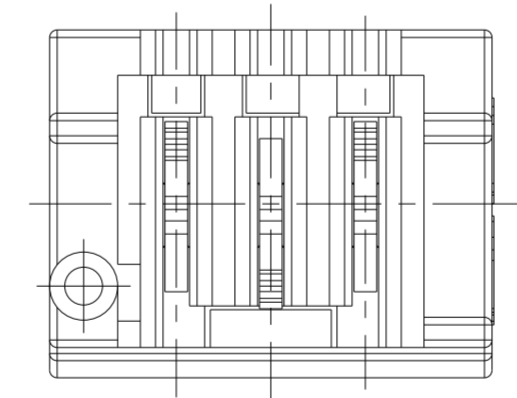
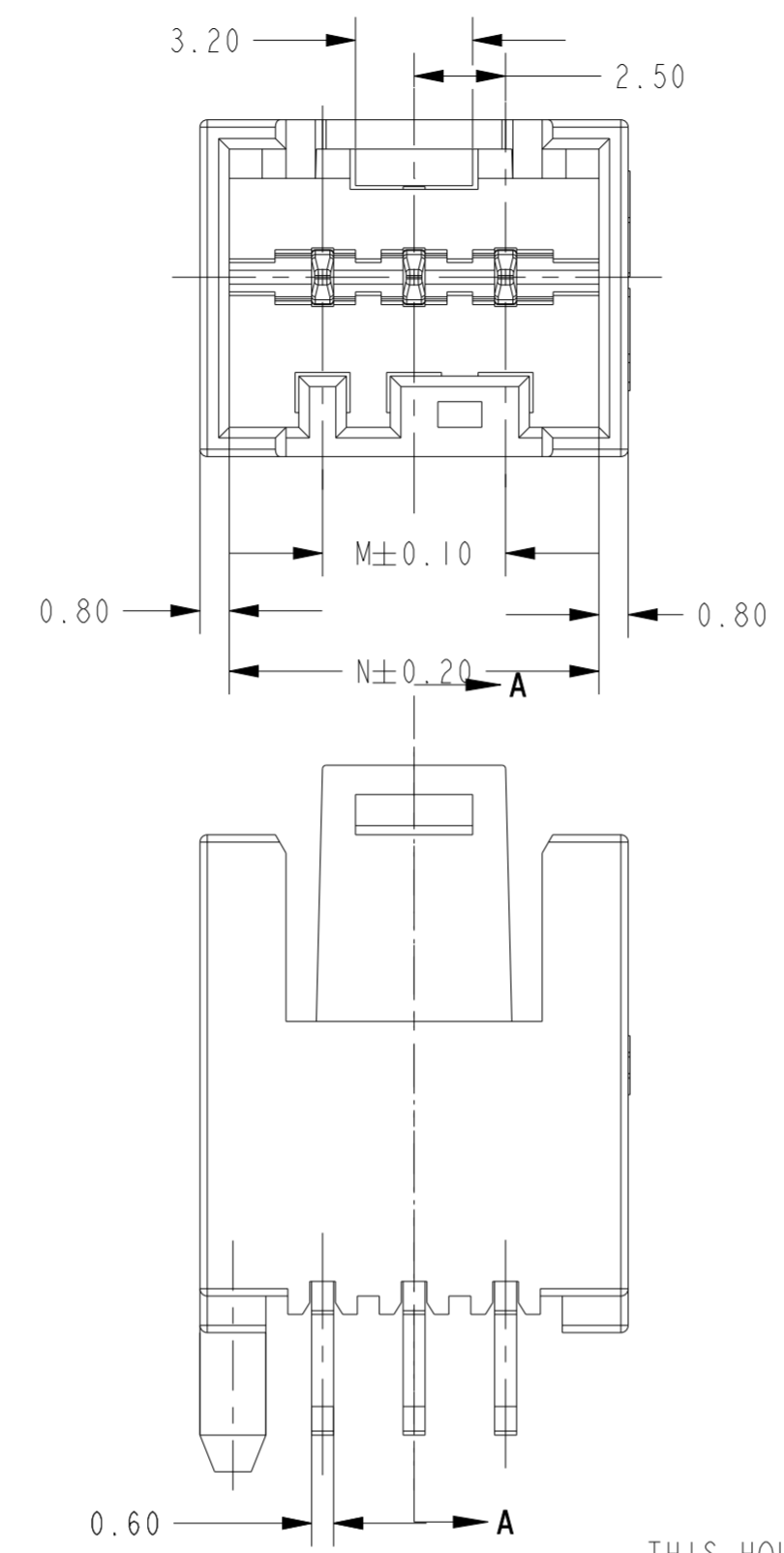

PCB LAYOUT - SOLDER SIDE FOR P/N: 7-1971817-5

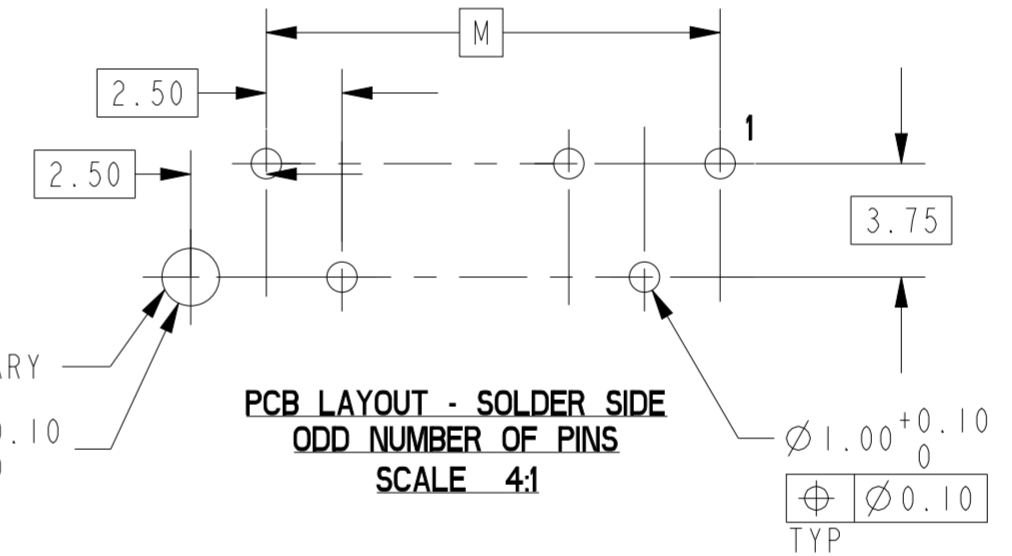

PCB LAYOUT - SOLDER SIDE ODD NUMBER OF PINS SCALE 4:1

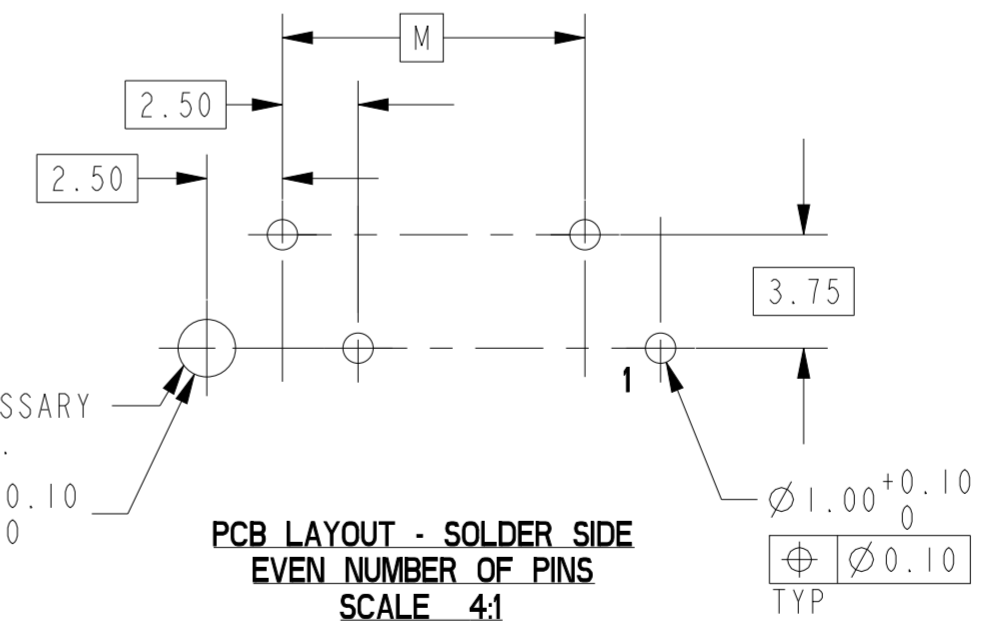

PCB LAYOUT - SOLDER SIDE EVEN NUMBER OF PINS SCALE 4:1

THIS HOLE IS NOT NECESSARY FOR PRODUCT OF NOTE 9.

THIS HOLE IS NOT NECESSARY FOR PRODUCT OF NOTE 9.

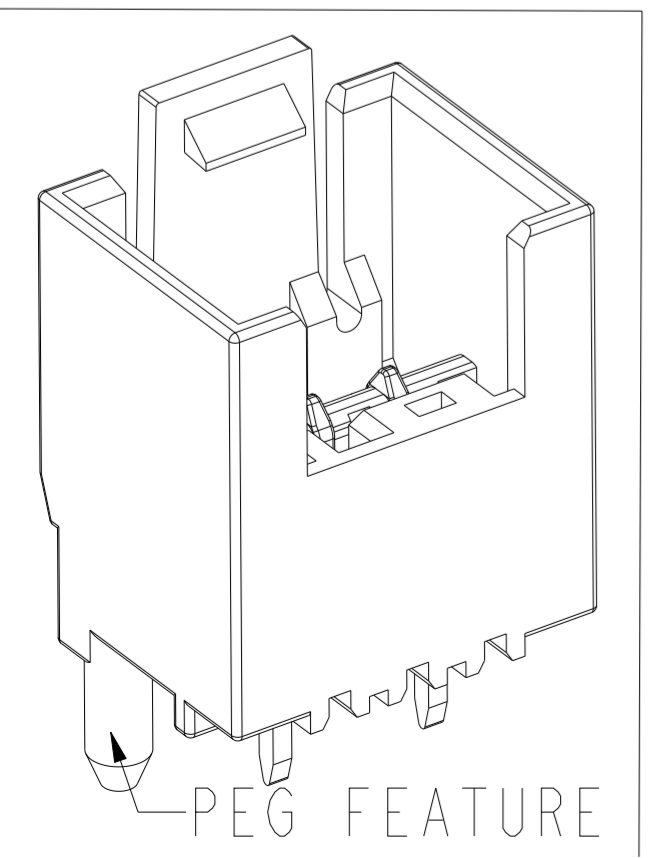

PEG FEATURE

40.10	35.00	15
37.60	32.50	14
35.10	30.00	13
32.60	27.50	12
30.10	25.00	11
27.60	22.50	10
25.10	20.00	9
22.60	17.50	8
20.10	15.00	7
17.60	12.50	6
15.10	10.00	5
12.60	7.50	4
10.10	5.00	3
N	M	NO. OF POS.

THIS DRAWING IS A CONTROLLED DOCUMENT.

DIMENSIONS: mm	TOLERANCES UNLESS OTHERWISE SPECIFIED:	DWN: WINTER WANG 12NOV2012	TE Connectivity
		CHK: HAPYE WU 12NOV2012	
		APVD: YUHONG MAO 12NOV2012	
		PRODUCT SPEC: 108-106079	
MATERIAL:	FINISH:	APPLICATION SPEC:	NAME: RAST 2.5 TAB HEADER ASSY TH, VERTICAL, EXTERNAL LOCKING
		WEIGHT:	SIZE: A2 CAGE CODE: 00779 DRAWING NO: C-1971817 RESTRICTED TO:
		CUSTOMER DRAWING	SCALE: 5:1 SHEET 1 OF 6 REV: A18

THIS DRAWING IS UNPUBLISHED. RELEASED FOR PUBLICATION 20
 © COPYRIGHT 20 BY - ALL RIGHTS RESERVED.

LOC		DIST		REVISIONS			
P	LTR	DESCRIPTION	DATE	DWN	APVD		
ES	00						

QTY	TAB CONTACT	QTY	HOUSING	POS.	TE PART NO.	QTY	TAB CONTACT	QTY	HOUSING	POS.	TE PART NO.		
15	TAB CONTACT w/ SILVER PLATING	1	RAST 2.5 TAB HEADER HOUSING, EXTERNAL LOCKING, 15P (SEE THE DETAIL LAYOUT ON SHEET 5)	15	3-1971838-5 2-1971838-5 1-1971838-5	4	TAB CONTACT w/ SILVER PLATING	1	RAST 2.5 TAB HEADER HOUSING, EXTERNAL LOCKING, 10P (SEE THE DETAIL LAYOUT ON SHEET 5)	10	3-1971837-0 2-1971837-0 1-1971837-0		
9		1	RAST 2.5 TAB HEADER HOUSING, EXTERNAL LOCKING, 14P (SEE THE DETAIL LAYOUT ON SHEET 5)	14	2-1971838-4 1-1971838-4			9	1	RAST 2.5 TAB HEADER HOUSING, EXTERNAL LOCKING, 9P (SEE THE DETAIL LAYOUT ON SHEET 5)	9	7-1971837-9 6-1971837-9 5-1971837-9 4-1971837-9 3-1971837-9 2-1971837-9 1-1971837-9	
14		1	RAST 2.5 TAB HEADER HOUSING, EXTERNAL LOCKING, 13P (SEE THE DETAIL LAYOUT ON SHEET 5)	13	1-1971838-3				8	1	RAST 2.5 TAB HEADER HOUSING, EXTERNAL LOCKING, 8P (SEE THE DETAIL LAYOUT ON SHEET 5)	8	5-1971837-8 4-1971837-8 3-1971837-8 2-1971837-8 1-1971837-8
13		1	RAST 2.5 TAB HEADER HOUSING, EXTERNAL LOCKING, 12P (SEE THE DETAIL LAYOUT ON SHEET 5)	12	2-1971838-2 1-1971838-2	7		1		RAST 2.5 TAB HEADER HOUSING, EXTERNAL LOCKING, 7P (SEE THE DETAIL LAYOUT ON SHEET 5)	7	7-1971837-7 6-1971837-7 5-1971837-7 4-1971837-7 3-1971837-7 2-1971837-7 1-1971837-7	
8		1	RAST 2.5 TAB HEADER HOUSING, EXTERNAL LOCKING, 11P (SEE THE DETAIL LAYOUT ON SHEET 5)	11	2-1971838-1 1-1971838-1			6	1	RAST 2.5 TAB HEADER HOUSING, EXTERNAL LOCKING, 6P (SEE THE DETAIL LAYOUT ON SHEET 5)	6	4-1971837-6 3-1971837-6 2-1971837-6 1-1971837-6	
12		1	RAST 2.5 TAB HEADER HOUSING, EXTERNAL LOCKING, 10P (SEE THE DETAIL LAYOUT ON SHEET 5)	10	3-1971837-5 2-1971837-5 1-1971837-5	5			1	RAST 2.5 TAB HEADER HOUSING, EXTERNAL LOCKING, 5P (SEE THE DETAIL LAYOUT ON SHEET 5)	5	4-1971837-5 3-1971837-5 2-1971837-5 1-1971837-5	
11		1	RAST 2.5 TAB HEADER HOUSING, EXTERNAL LOCKING, 9P (SEE THE DETAIL LAYOUT ON SHEET 5)	9	7-1971837-4 6-1971837-4 5-1971837-4 4-1971837-4 3-1971837-4 2-1971837-4 1-1971837-4			4	1	RAST 2.5 TAB HEADER HOUSING, EXTERNAL LOCKING, 4P (SEE THE DETAIL LAYOUT ON SHEET 5)	4	7-1971837-4 6-1971837-4 5-1971837-4 4-1971837-4 3-1971837-4 2-1971837-4 1-1971837-4	
QTY		TAB CONTACT	QTY	HOUSING	POS.	TE PART NO.			QTY	TAB CONTACT	QTY	HOUSING	POS.

THIS DRAWING IS A CONTROLLED DOCUMENT.

DIMENSIONS: mm	TOLERANCES UNLESS OTHERWISE SPECIFIED: 0 PLC ± 1 PLC ± 2 PLC ±0.20 3 PLC ± 4 PLC ± ANGLES ±1° FINISH	DWN WINTER WANG 12NOV2012 CHK HAPYE WU 12NOV2012 APVD YUHONG MAO 12NOV2012	NAME RAST 2.5 TAB HEADER ASSY TH, VERTICAL, EXTERNAL LOCKING
MATERIAL		PRODUCT SPEC APPLICATION SPEC	SIZE A2 CAGE CODE 00779 DRAWING NO C-1971817 RESTRICTED TO
		WEIGHT	SCALE 5:1 SHEET 2 OF 6 REV A18

CUSTOMER DRAWING

THIS DRAWING IS UNPUBLISHED. RELEASED FOR PUBLICATION 20
 © COPYRIGHT 20 BY - ALL RIGHTS RESERVED.

LOC	DIST	REVISIONS					
ES	00	P	LTR	DESCRIPTION	DATE	DWN	APVD

QTY	TAB CONTACT	QTY	HOUSING	POS.	TE PART NO.						
10	TAB CONTACT w/ TIN PLATING	1	RAST 2.5 TAB HEADER HOUSING, EXTERNAL LOCKING, 10P (SEE THE DETAIL LAYOUT ON SHEET 5)	10	3-1971817-0 2-1971817-0 1-1971817-0						
9		1	RAST 2.5 TAB HEADER HOUSING, EXTERNAL LOCKING, 9P (SEE THE DETAIL LAYOUT ON SHEET 5)	9	7-1971817-9 6-1971817-9 5-1971817-9 4-1971817-9 3-1971817-9 2-1971817-9 1-1971817-9						
6					1	RAST 2.5 TAB HEADER HOUSING, EXTERNAL LOCKING, 8P (SEE THE DETAIL LAYOUT ON SHEET 5)	8	5-1971817-8 4-1971817-8 3-1971817-8 2-1971817-8 1-1971817-8			
9								1	RAST 2.5 TAB HEADER HOUSING, EXTERNAL LOCKING, 7P (SEE THE DETAIL LAYOUT ON SHEET 5)	7	7-1971817-7 6-1971817-7 5-1971817-7 4-1971817-7 3-1971817-7 2-1971817-7 1-1971817-7
8											1
6					1	RAST 2.5 TAB HEADER HOUSING, EXTERNAL LOCKING, 5P (SEE THE DETAIL LAYOUT ON SHEET 5)	5				
5											1
2		1	RAST 2.5 TAB HEADER HOUSING, EXTERNAL LOCKING, 3P (SEE THE DETAIL LAYOUT ON SHEET 5)	3				1-2322471-3 1-2335894-3 2335894-3 1971817-3 9-1971817-3 8-1971817-3 7-1971817-3 6-1971817-3 5-1971817-3 4-1971817-3 3-1971817-3 2-1971817-3 1-1971817-3			
5											
2											
5											

15	TAB CONTACT w/ TIN PLATING	1	RAST 2.5 TAB HEADER HOUSING, EXTERNAL LOCKING, 15P (SEE THE DETAIL LAYOUT ON SHEET 5)	15	3-1971818-5 2-1971818-5 1-1971818-5			
9		1	RAST 2.5 TAB HEADER HOUSING, EXTERNAL LOCKING, 14P (SEE THE DETAIL LAYOUT ON SHEET 5)	14	2-1971818-4 1-1971818-4			
14					1	RAST 2.5 TAB HEADER HOUSING, EXTERNAL LOCKING, 13P (SEE THE DETAIL LAYOUT ON SHEET 5)	13	1-1971818-3
13		1	RAST 2.5 TAB HEADER HOUSING, EXTERNAL LOCKING, 12P (SEE THE DETAIL LAYOUT ON SHEET 5)	12				2-1971818-2 1-1971818-2
8								1
12								
11								
QTY		TAB CONTACT	QTY	HOUSING	POS.	TE PART NO. \triangle 5		

THIS DRAWING IS A CONTROLLED DOCUMENT.

DWN: WINTER WANG 12NOV2012
 CHK: HAPYE WU 12NOV2012
 APVD: YUHONG MAO 12NOV2012

STE TE Connectivity

NAME: RAST 2.5 TAB HEADER ASSY TH, VERTICAL, EXTERNAL LOCKING

SIZE: A2 CAGE CODE: 00779 DRAWING NO: C-1971817 RESTRICTED TO: -

MATERIAL: - FINISH: - WEIGHT: -

CUSTOMER DRAWING SCALE: 5:1 SHEET 3 OF 6 REV: A18

4

3

2

1

THIS DRAWING IS UNPUBLISHED.	RELEASED FOR PUBLICATION	20
© COPYRIGHT 20 BY -	ALL RIGHTS RESERVED.	

LOC	DIST	REVISIONS					
ES	00	P	LTR	DESCRIPTION	DATE	DWN	APVD

△ 9 SPECIAL VERSION WITHOUT PEG FEATURE.

OTHER DIMENSIONS SEE SHEET 1, PCB LAYOUT SEE SHEET 1

15		1		15	2362614-5	△ 8
14		1		14	2362614-4	△ 8
13		1		13	2362614-3	△ 8
12		1		12	2362614-2	△ 8
11		1		11	2362614-1	△ 8
10		1		10	2350434-0	△ 8
9	TAB CONTACT w/ TIN PLATING	1	RAST 2.5 TAB HEADER HOUSING EXTERNAL LOCKING WITHOUT PEG TBD ON DETAIL LAYOUT	9	2350434-9	△ 8
8		1		8	2350434-8	△ 8
7		1		7	2350434-7	△ 8
6		1		6	2350434-6	△ 8
5		1		5	2350434-5	△ 8
4		1		4	2350434-4	△ 8
3		1	RAST 2.5 TAB HEADER HOUSING, EXTERNAL LOCKING, 3P WITHOUT PEG (SEE THE DETAIL LAYOUT ON SHEET 5)	3	2350434-3	△ 8
QTY	TAB CONTACT	QTY	HOUSING	POS.	TE PART NO.	△ 5

THIS DRAWING IS A CONTROLLED DOCUMENT.		DWN	12NOV2012	 TE Connectivity			
DIMENSIONS:		CHK	12NOV2012				
mm		APVD	12NOV2012				
TOLERANCES UNLESS OTHERWISE SPECIFIED:		NAME	YUHONG MAO				
0 PLC	±	PRODUCT SPEC		RAST 2.5 TAB HEADER ASSY TH, VERTICAL, EXTERNAL LOCKING			
1 PLC	±	APPLICATION SPEC					
2 PLC	±0.20	WEIGHT		SIZE	CAGE CODE	DRAWING NO	RESTRICTED TO
3 PLC	±	CUSTOMER DRAWING		A2	00779	C-1971817	
4 PLC	±	SCALE	5:1	SHEET	4	OF	6
ANGLES	±1°			REV	A18		
FINISH							

1471-9 (3/11)

C

B

A

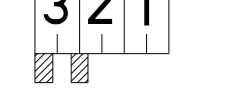

7-1971817-3

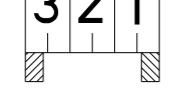

9-1971817-3

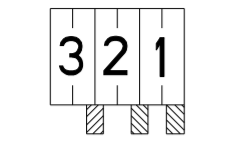

8-1971817-3

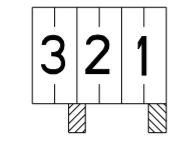

1971817-3

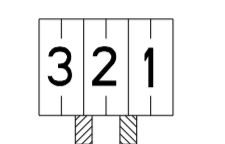

8-1971837-3

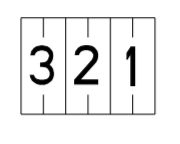

1971837-3



1-2335894-3

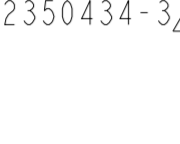

2335894-3

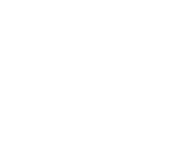

2350434-3



3 POS



4-1971817-4

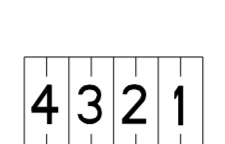

5-1971817-4



6-1971817-4

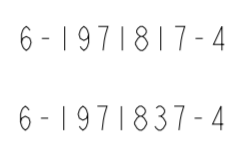

7-1971817-4



7-1971837-4

4 POS



4-1971817-5



6-1971817-5

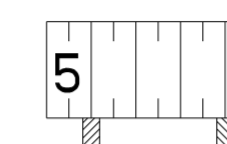

7-1971817-5

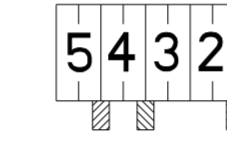

8-1971817-5



9-1971817-5



5 POS



4-1971817-6



6-1971817-7



7-1971817-7



6-1971837-7

6 POS



4-1971817-7

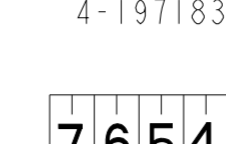

5-1971817-7



7-1971817-7

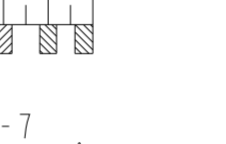

7-1971837-7

7 POS



3-1971817-8

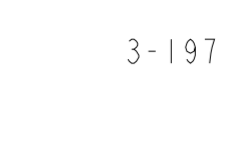

5-1971817-8



5-1971837-8

8 POS

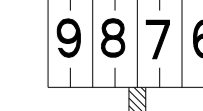

4-1971817-9

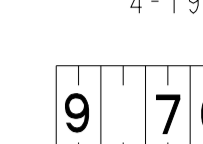

6-1971817-9

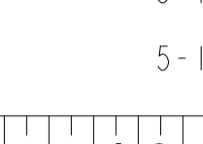

6-1971837-9

9 POS

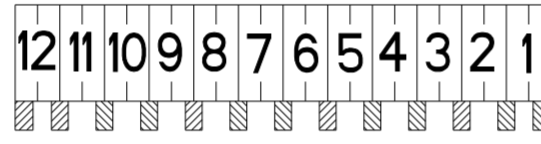

1-1971818-2



1-1971838-2

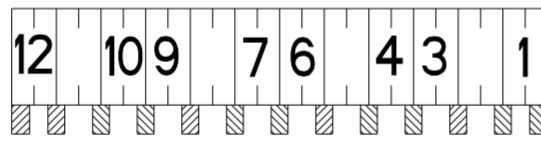

2-1971818-2



2-1971838-2

12 POS

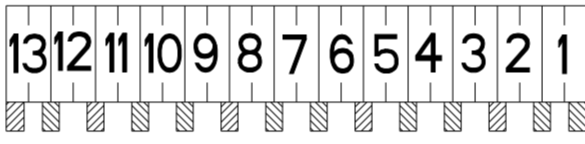

1-1971818-3



1-1971838-3

13 POS

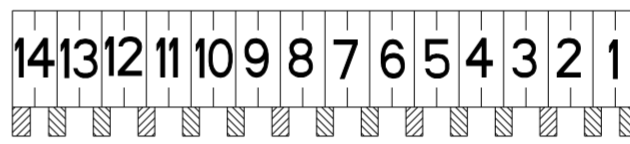

1-1971818-4



1-1971838-4

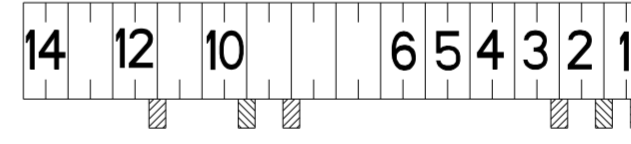

2-1971818-4



2-1971838-4

14 POS

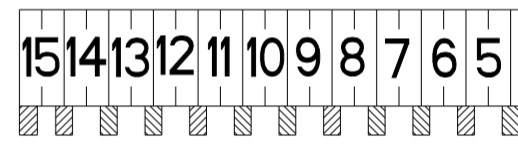

1-1971818-5



1-1971838-5

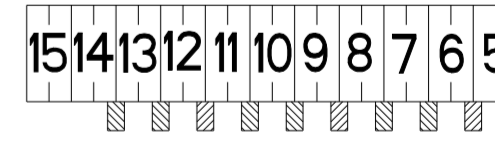

3-1971818-5



3-1971838-5

15 POS

THIS DRAWING IS UNPUBLISHED. RELEASED FOR PUBLICATION 20
 © COPYRIGHT 20 BY - ALL RIGHTS RESERVED.

LOC	DIST	REVISIONS					
ES	00	P	LTR	DESCRIPTION	DATE	DWN	APVD

FOR ANY KEYING CONFIGURATION, THERE ARE EIGHT COLORS AVAILABLE, BESIDES THE NATURAL COLOR, THERE ARE OTHER SEVEN COLORS, INCLUDE: YELLOW, BLUE, GREY, PURPLE, RED, GREEN, BLACK. THE WHITE VERSION IS PRELIMINARY. THE P/N OF THE COLOR CONNECTOR ARE BASED ON THE NATURAL CONNECTOR, THE PREFIX AND POSTFIX ARE THE SAME FOR THE SAME KEYING CONFIGURATION, BUT THE BASE NUMBERS ARE DIFFERENT ACCORDING TO DIFFERENT COLOR. THE FOLLOWING SHOWS WHAT'S THE P/N FOR COLOR CONNECTOR

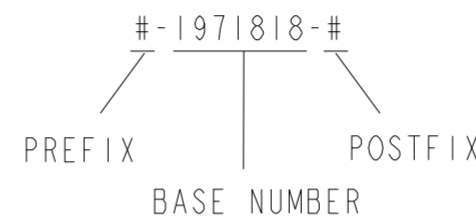

COLOR	PART NUMBER OF THE CONNECTOR				COMMENTS
	WITH TIN PLATING CONTACT		WITH AG PLATING CONTACT		
NATURAL	#-1971817-#	#-1971818-#	#-1971837-#	#-1971838-#	THE DETAIL P/N FOR DIFFERENT KEYING SEE SHEET 2 & 3 & 4
RED	#-1971938-#	#-1971939-#	#-2232141-#	#-2232142-#	THE PREFIX AND POSTFIX ARE THE SAME WITH THE P/N OF THE NATURAL CONNECTOR FOR THE SAME KEYING CONFIGURATION, JUST THE BASE NUMBERS ARE DIFFERENT BASED ON DIFFERENT COLOR. # CAN BE THE NUMBER FROM 0 TO 9.
BLUE	#-2232143-#	#-2232144-#	#-2232145-#	#-2232146-#	
YELLOW	#-2232147-#	#-2232148-#	#-2232149-#	#-2232150-#	
BALCK	#-1971994-#	#-1971995-#	#-2232151-#	#-2232152-#	
GREY	#-1971976-#	#-1971977-#	#-2232153-#	#-2232154-#	
GREEN	#-1971988-#	#-1971989-#	#-2232155-#	#-2232156-#	
PURPLE	#-2232157-#	#-2232158-#	#-2232159-#	#-2232160-#	
WHITE	#-2232277-#	#-2232278-#	#-2232279-#	#-2232280-#	

FOR EXAMPLE, IF A CONNECTOR WITH THE CONFIGURATION AS BELOW, AND WITH TIN PLATING CONTACT, IN THE SHEET 4, WE CAN FIND THE RELATED CONNECTOR P/N WITH NATURAL COLOR IS 5-1971817-4, THEN WE CAN LOOK IN THE ABOVE TABLE TO FIND THE CONNECTOR P/N WITH RED COLOR IS 5-1971938-4

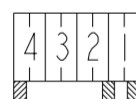

THIS DRAWING IS A CONTROLLED DOCUMENT.		DWN	12NOV2012	TE Connectivity
DIMENSIONS: mm		CHK	12NOV2012	
		TOLERANCES UNLESS OTHERWISE SPECIFIED:	APVD	
		0 PLC ± 1 PLC ± 2 PLC ±0.20 3 PLC ± 4 PLC ± ANGLES ±1° FINISH	YUHONG MAO	
MATERIAL	-	PRODUCT SPEC	108-106079	RAST 2.5 TAB HEADER ASSY TH, VERTICAL, EXTERNAL LOCKING
		APPLICATION SPEC	-	SIZE
		WEIGHT	-	CAGE CODE
		CUSTOMER DRAWING	A2	00779
		SCALE	5:1	DRAWING NO
		SHEET	6	OF 6
		REV	A18	RESTRICTED TO

X-ON Electronics

Largest Supplier of Electrical and Electronic Components

Click to view similar products for [Headers & Wire Housings](#) category:

Click to view products by [TE Connectivity](#) manufacturer:

Other Similar products are found below :

[892-18-020-10-001101](#) [58102-G61-06LF](#) [582553-1](#) [0009485154](#) [009176003701906](#) [0050291907](#) [LY20-4P-DT1-P1E-BR](#) [02.125.8002.8](#)
[609-3404](#) [61062-3](#) [61082-181009](#) [622-3653LF](#) [63453-116](#) [636-1030](#) [636-1427](#) [636-3427](#) [636-4007](#) [641938-9](#) [641991-4](#) [644827-2](#) [65817-010LF](#) [65817-015LF](#) [65863-015LF](#) [66207-023LF](#) [67095-007LF](#) [67601157](#) [68645-018](#) [68648-049](#) [70.362.1628.0](#) [70-4210](#) [70-4226B](#) [70-4853B](#) [707-5020](#) [707-5028](#) [71.350.2428.0](#) [71918-208LF](#) [71961-016LF](#) [733-134](#) [733-162](#) [754199-000](#) [760-3052](#) [787-8014-00](#) [79531-3000](#)
[FCN-360C032-B](#) [FCN-367T-T012/H](#) [FCN-723D010/2](#) [80.063.4001.1](#) [800-90-001-10-001000](#) [800-90-010-10-002000](#) [801-43-002-10-013000](#)