

THIS DRAWING IS UNPUBLISHED. RELEASED FOR PUBLICATION 20
 © COPYRIGHT 20 BY - ALL RIGHTS RESERVED.

LOC		DIST		REVISIONS			
P	LTR	DESCRIPTION		DATE	DWN	APVD	
ES	00	A18	ECR-21-100790	04MAR2021	PJ	FL	

- NOTE**
- SEE SHEET 4 FOR AVAILABLE CONFIGURATIONS
 - MATERIAL: HOUSING, NYLON, UL94 V0, 750°C GWT NO FLAME
 EIGHT COLORS AVAILABLE, INCLUDING: NATURAL, RED, BLUE, YELLOW, BLACK, GREY, GREEN, PURPLE
 WHITE VERSION IS PRELIMINARY
 FOR 1-2367449-1, THE HOUSING IS PA66 WITH HIGHER THERMAL RESISTANCE
 CONTACT, COPPER ALLOY, 0.60MM THICK
 - FINISH: OPTION 1: TIN PLATING OVER NICKEL UNDERPLATING
 OPTION 2: AG PLATING OVER NICKEL UNDERPLATING
 - PCB LAYOUT AS SHOWN
 - THE PART NUMBERS SHOWING IN SHEET 2 & 3 & 4 ARE FOR NATURAL COLOR. THE PART NUMBER FOR OTHER COLOR ARE BASED ON THE NATURAL ONE: FOR THE SAME CONFIGURATION, THE PREFIX AND POSTFIX OF THE P/N ARE THE SAME, ONLY THE BASE NUMBER IS DIFFERENT ACCORDING TO DIFFERENT COLOR, DETAIL PLEASE SEE SHEET 6
 - PACKAGING: LOOSE PIECE OR TUBE. THE PART NUMBERS IN THIS DRAWING ARE WITH LOOSE PIECE PACKAGING EXCEPT THE PN 1-2322471-3. PLEASE CONTACT TE SALES REPRESENTATIVES FOR TUBE PACKAGING REQUIREMENT.
 - FOR PN 7-1971817-5 PIN LAYOUT AS FOLLOW
 - PRELIMINARY PART NOT RELEASED FOR PRODUCTION
 - SPECIAL VERSION WITHOUT PEG FEATURE.

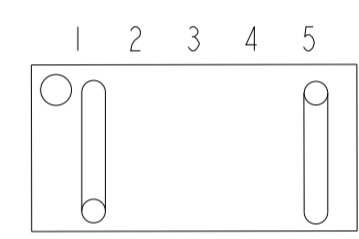

PN 5-1971817-5: PCB LAYOUT FOR ODD NUMBERS OF PINS APPLIES (THE POSITION OF THE PINS 1 AND 5 ARE SAME AS 1-1971817-5).

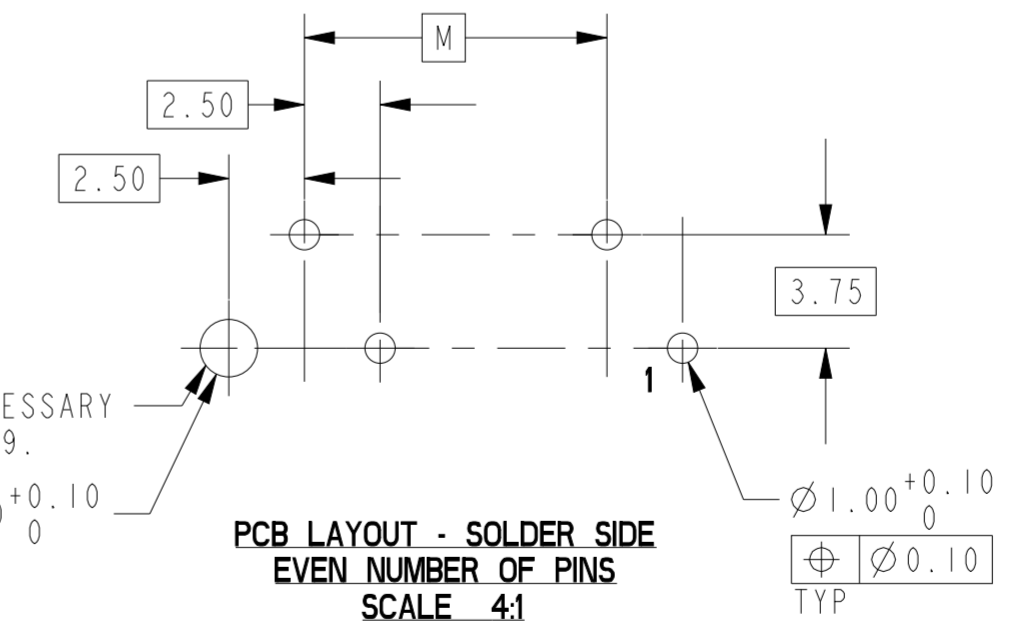
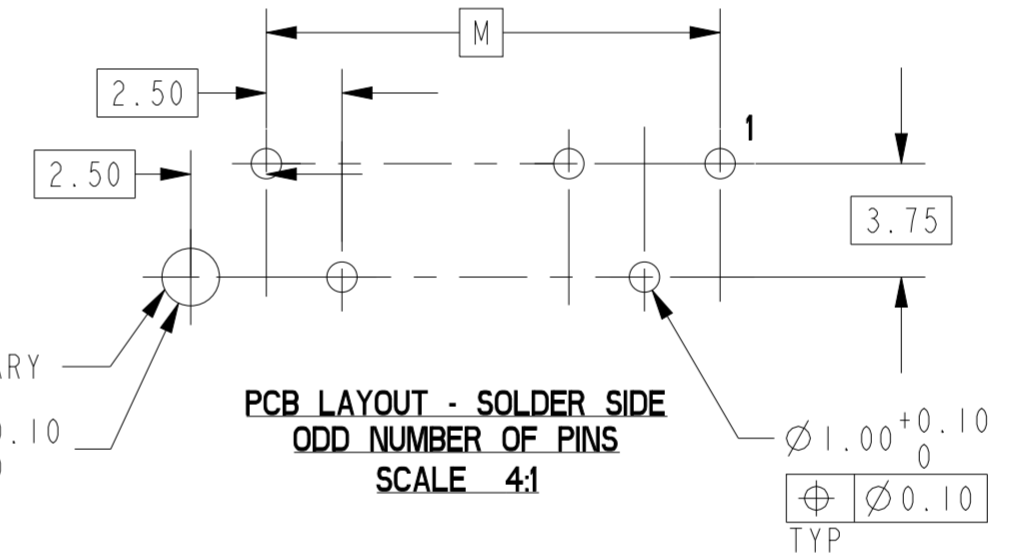
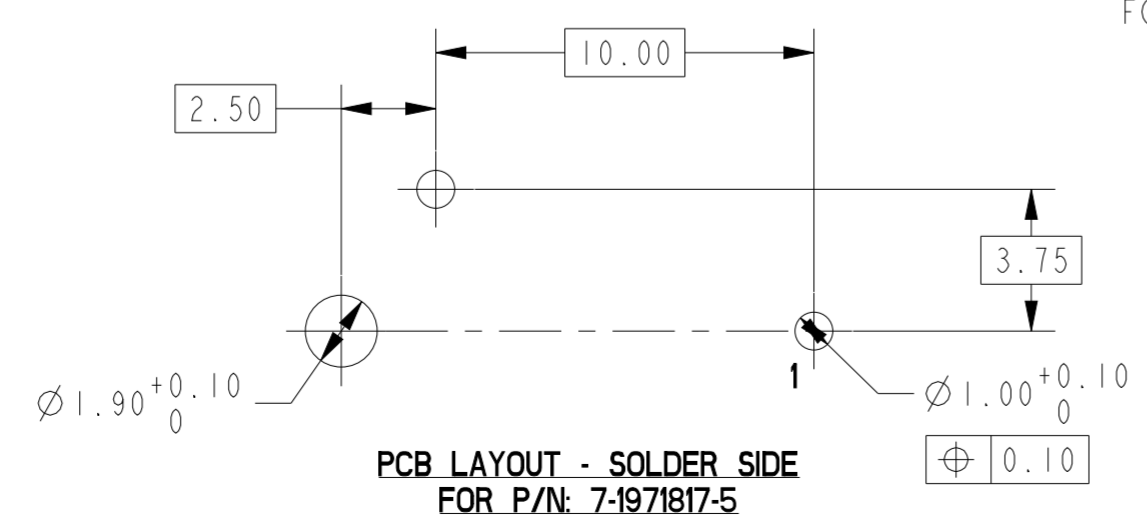
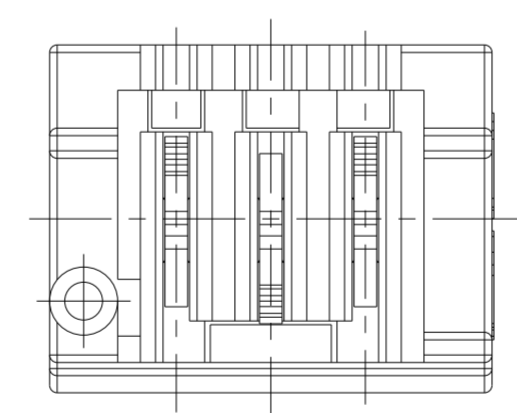
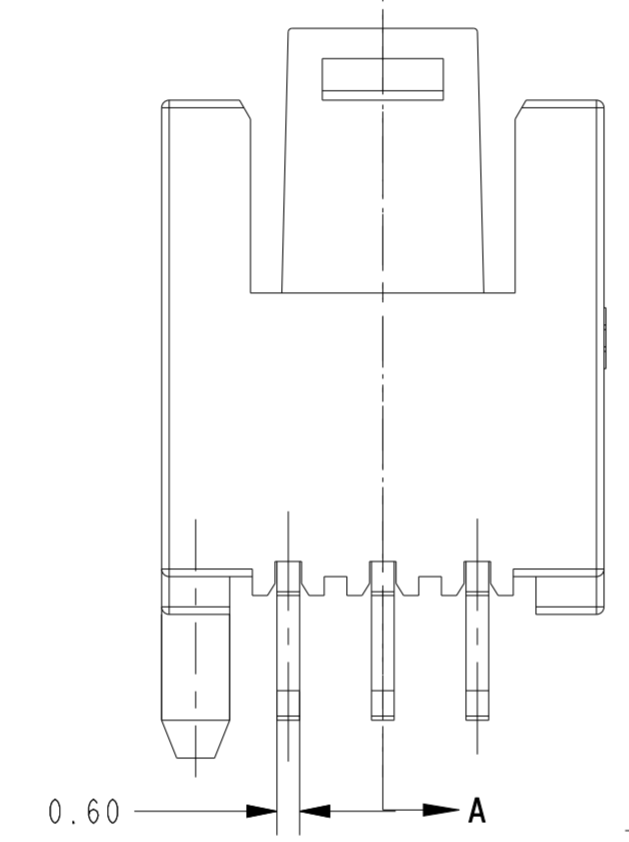
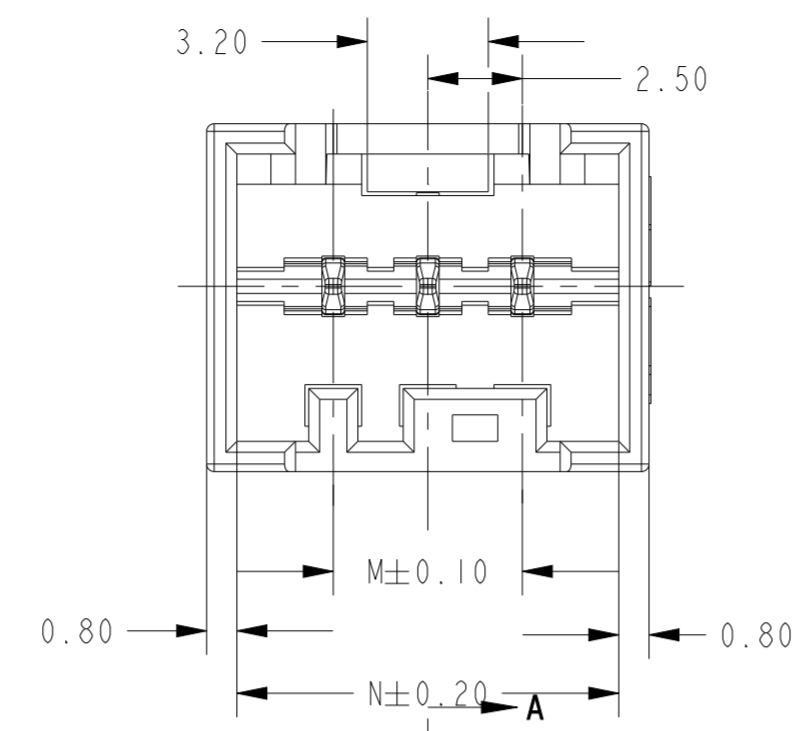
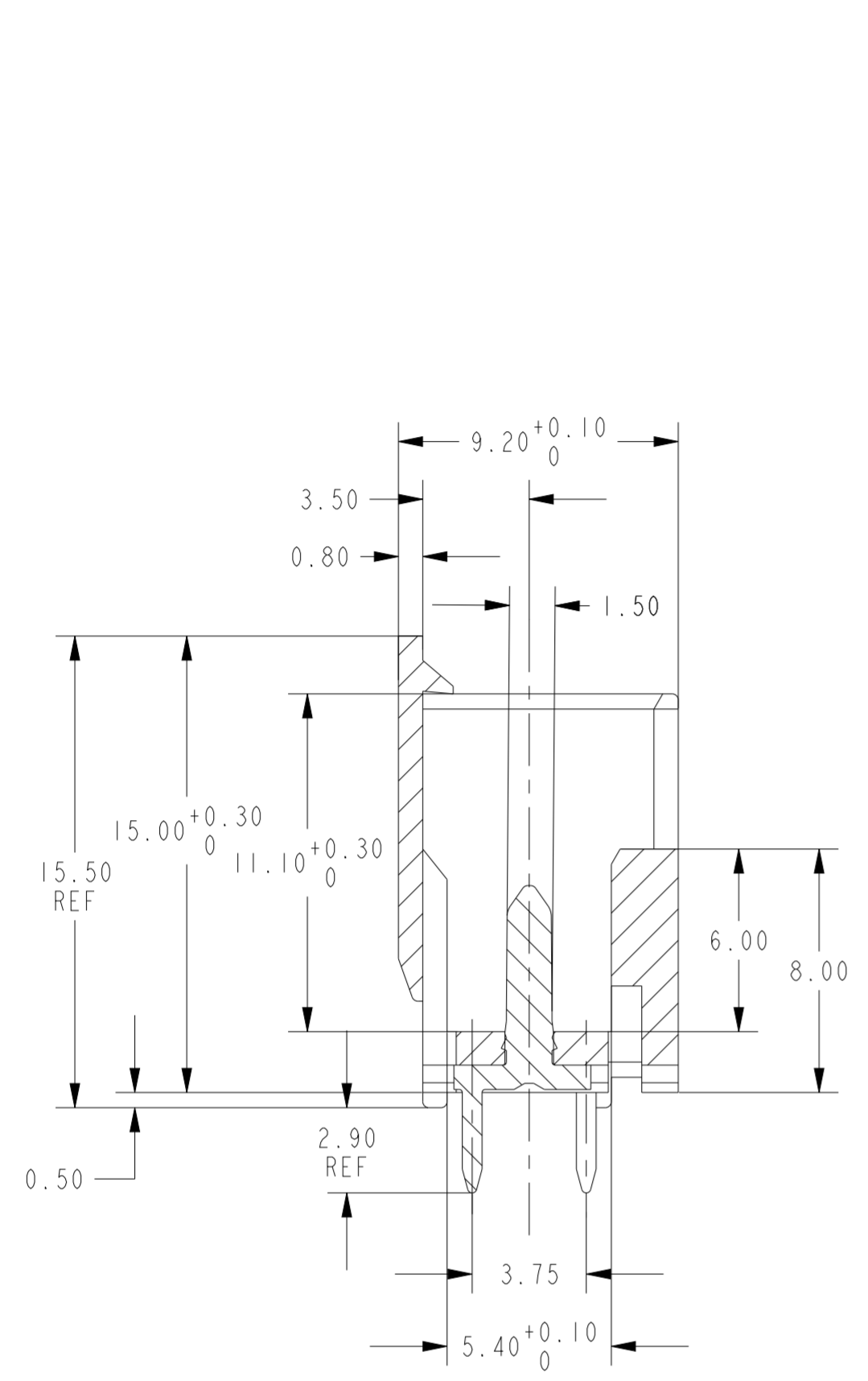

THIS HOLE IS NOT NECESSARY FOR PRODUCT OF NOTE 9.

THIS HOLE IS NOT NECESSARY FOR PRODUCT OF NOTE 9.

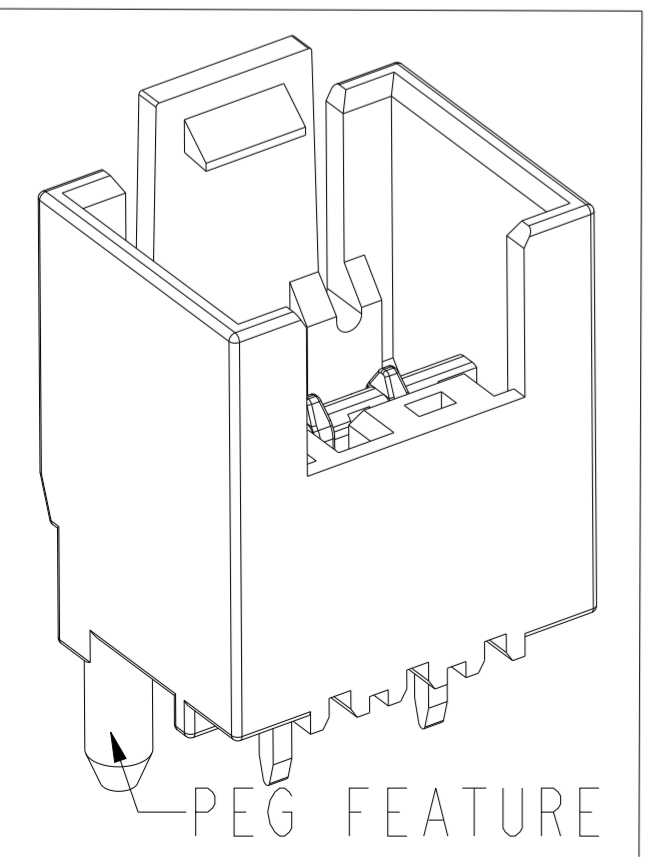

40.10	35.00	15
37.60	32.50	14
35.10	30.00	13
32.60	27.50	12
30.10	25.00	11
27.60	22.50	10
25.10	20.00	9
22.60	17.50	8
20.10	15.00	7
17.60	12.50	6
15.10	10.00	5
12.60	7.50	4
10.10	5.00	3
N	M	NO. OF POS.

THIS DRAWING IS A CONTROLLED DOCUMENT.

DIMENSIONS: mm	TOLERANCES UNLESS OTHERWISE SPECIFIED:	DWN: WINTER WANG 12NOV2012	TE Connectivity
0 PLC ±	1 PLC ±	CHK: HAPYE WU 12NOV2012	
2 PLC ±0.20	3 PLC ±	APVD: YUHONG MAO 12NOV2012	NAME: RAST 2.5 TAB HEADER ASSY TH, VERTICAL, EXTERNAL LOCKING
4 PLC ±	ANGLES ±°	PRODUCT SPEC: 108-106079	SIZE: A2
MATERIAL: -	FINISH: -	APPLICATION SPEC: -	CAGE CODE: 00779
		WEIGHT: -	DRAWING NO: C-1971817
		CUSTOMER DRAWING	RESTRICTED TO: -

SCALE: 5:1 SHEET 1 OF 6 REV: A18

THIS DRAWING IS UNPUBLISHED. RELEASED FOR PUBLICATION 20
 © COPYRIGHT 20 BY - ALL RIGHTS RESERVED.

LOC	DIST	REVISIONS					
ES	00	P	LTR	DESCRIPTION	DATE	DWN	APVD

QTY	TAB CONTACT	QTY	HOUSING	POS.	TE PART NO.	QTY	TAB CONTACT	QTY	HOUSING	POS.	TE PART NO.		
15	TAB CONTACT w/ SILVER PLATING	1	RAST 2.5 TAB HEADER HOUSING, EXTERNAL LOCKING, 15P (SEE THE DETAIL LAYOUT ON SHEET 5)	15	3-1971838-5 2-1971838-5 1-1971838-5	4	TAB CONTACT w/ SILVER PLATING	1	RAST 2.5 TAB HEADER HOUSING, EXTERNAL LOCKING, 10P (SEE THE DETAIL LAYOUT ON SHEET 5)	10	3-1971837-0 2-1971837-0 1-1971837-0		
9		1	RAST 2.5 TAB HEADER HOUSING, EXTERNAL LOCKING, 14P (SEE THE DETAIL LAYOUT ON SHEET 5)	14	2-1971838-4 1-1971838-4			9	1	RAST 2.5 TAB HEADER HOUSING, EXTERNAL LOCKING, 9P (SEE THE DETAIL LAYOUT ON SHEET 5)	9	7-1971837-9 6-1971837-9 5-1971837-9 4-1971837-9 3-1971837-9 2-1971837-9 1-1971837-9	
14		1	RAST 2.5 TAB HEADER HOUSING, EXTERNAL LOCKING, 13P (SEE THE DETAIL LAYOUT ON SHEET 5)	13	1-1971838-3				8	1	RAST 2.5 TAB HEADER HOUSING, EXTERNAL LOCKING, 8P (SEE THE DETAIL LAYOUT ON SHEET 5)	8	5-1971837-8 4-1971837-8 3-1971837-8 2-1971837-8 1-1971837-8
13		1	RAST 2.5 TAB HEADER HOUSING, EXTERNAL LOCKING, 12P (SEE THE DETAIL LAYOUT ON SHEET 5)	12	2-1971838-2 1-1971838-2	7		1		RAST 2.5 TAB HEADER HOUSING, EXTERNAL LOCKING, 7P (SEE THE DETAIL LAYOUT ON SHEET 5)	7	7-1971837-7 6-1971837-7 5-1971837-7 4-1971837-7 3-1971837-7 2-1971837-7 1-1971837-7	
8		1	RAST 2.5 TAB HEADER HOUSING, EXTERNAL LOCKING, 11P (SEE THE DETAIL LAYOUT ON SHEET 5)	11	2-1971838-1 1-1971838-1			6	1	RAST 2.5 TAB HEADER HOUSING, EXTERNAL LOCKING, 6P (SEE THE DETAIL LAYOUT ON SHEET 5)	6	4-1971837-6 3-1971837-6 2-1971837-6 1-1971837-6	
12		1	RAST 2.5 TAB HEADER HOUSING, EXTERNAL LOCKING, 10P (SEE THE DETAIL LAYOUT ON SHEET 5)	10	3-1971837-5 2-1971837-5 1-1971837-5	5			1	RAST 2.5 TAB HEADER HOUSING, EXTERNAL LOCKING, 5P (SEE THE DETAIL LAYOUT ON SHEET 5)	5	4-1971837-5 3-1971837-5 2-1971837-5 1-1971837-5	
11		1	RAST 2.5 TAB HEADER HOUSING, EXTERNAL LOCKING, 9P (SEE THE DETAIL LAYOUT ON SHEET 5)	9	7-1971837-4 6-1971837-4 5-1971837-4 4-1971837-4 3-1971837-4 2-1971837-4 1-1971837-4			4	1	RAST 2.5 TAB HEADER HOUSING, EXTERNAL LOCKING, 4P (SEE THE DETAIL LAYOUT ON SHEET 5)	4	7-1971837-4 6-1971837-4 5-1971837-4 4-1971837-4 3-1971837-4 2-1971837-4 1-1971837-4	
QTY		TAB CONTACT	QTY	HOUSING	POS.	TE PART NO.			QTY	TAB CONTACT	QTY	HOUSING	POS.

THIS DRAWING IS A CONTROLLED DOCUMENT.

DIMENSIONS: mm	TOLERANCES UNLESS OTHERWISE SPECIFIED: 0 PLC ± 1 PLC ± 2 PLC ±0.20 3 PLC ± 4 PLC ± ANGLES ±1° FINISH	DWN WINTER WANG 12NOV2012 CHK HAPYE WU 12NOV2012 APVD YUHONG MAO 12NOV2012	TE Connectivity NAME RAST 2.5 TAB HEADER ASSY TH, VERTICAL, EXTERNAL LOCKING SIZE A2 CAGE CODE 00779 DRAWING NO C-1971817 RESTRICTED TO SCALE 5:1 SHEET 2 OF 6 REV A18	
MATERIAL		PRODUCT SPEC - APPLICATION SPEC - WEIGHT -	CUSTOMER DRAWING	

THIS DRAWING IS UNPUBLISHED. RELEASED FOR PUBLICATION 20
 © COPYRIGHT 20 BY - ALL RIGHTS RESERVED.

LOC	DIST	REVISIONS					
ES	00	P	LTR	DESCRIPTION	DATE	DWN	APVD

QTY	TAB CONTACT	QTY	HOUSING	POS.	TE PART NO.						
10	TAB CONTACT w/ TIN PLATING	1	RAST 2.5 TAB HEADER HOUSING, EXTERNAL LOCKING, 10P (SEE THE DETAIL LAYOUT ON SHEET 5)	10	3-1971817-0 2-1971817-0 1-1971817-0						
9		1	RAST 2.5 TAB HEADER HOUSING, EXTERNAL LOCKING, 9P (SEE THE DETAIL LAYOUT ON SHEET 5)	9	7-1971817-9 6-1971817-9 5-1971817-9 4-1971817-9 3-1971817-9 2-1971817-9 1-1971817-9						
6					1	RAST 2.5 TAB HEADER HOUSING, EXTERNAL LOCKING, 8P (SEE THE DETAIL LAYOUT ON SHEET 5)	8	5-1971817-8 4-1971817-8 3-1971817-8 2-1971817-8 1-1971817-8			
9								1	RAST 2.5 TAB HEADER HOUSING, EXTERNAL LOCKING, 7P (SEE THE DETAIL LAYOUT ON SHEET 5)	7	7-1971817-7 6-1971817-7 5-1971817-7 4-1971817-7 3-1971817-7 2-1971817-7 1-1971817-7
8											1
6					1	RAST 2.5 TAB HEADER HOUSING, EXTERNAL LOCKING, 5P (SEE THE DETAIL LAYOUT ON SHEET 5)	5				
5											1
2		1	RAST 2.5 TAB HEADER HOUSING, EXTERNAL LOCKING, 3P (SEE THE DETAIL LAYOUT ON SHEET 5)	3				1-2322471-3 1-2335894-3 2335894-3 1971817-3 9-1971817-3 8-1971817-3 7-1971817-3 6-1971817-3 5-1971817-3 4-1971817-3 3-1971817-3 2-1971817-3 1-1971817-3			
5											
2											
5											

15	TAB CONTACT w/ TIN PLATING	1	RAST 2.5 TAB HEADER HOUSING, EXTERNAL LOCKING, 15P (SEE THE DETAIL LAYOUT ON SHEET 5)	15	3-1971818-5 2-1971818-5 1-1971818-5			
9		1	RAST 2.5 TAB HEADER HOUSING, EXTERNAL LOCKING, 14P (SEE THE DETAIL LAYOUT ON SHEET 5)	14	2-1971818-4 1-1971818-4			
14					1	RAST 2.5 TAB HEADER HOUSING, EXTERNAL LOCKING, 13P (SEE THE DETAIL LAYOUT ON SHEET 5)	13	1-1971818-3
13		1	RAST 2.5 TAB HEADER HOUSING, EXTERNAL LOCKING, 12P (SEE THE DETAIL LAYOUT ON SHEET 5)	12				2-1971818-2 1-1971818-2
8								1
12								
11								
QTY		TAB CONTACT	QTY	HOUSING	POS.	TE PART NO.		

THIS DRAWING IS A CONTROLLED DOCUMENT.

DWN: WINTER WANG 12NOV2012
 CHK: HAPYE WU 12NOV2012
 APVD: YUHONG MAO 12NOV2012

STE TE Connectivity

NAME: RAST 2.5 TAB HEADER ASSY TH, VERTICAL, EXTERNAL LOCKING

SIZE: A2 CAGE CODE: 00779 DRAWING NO: C-1971817 RESTRICTED TO: -

MATERIAL: - FINISH: - WEIGHT: -

CUSTOMER DRAWING SCALE: 5:1 SHEET 3 OF 6 REV: A18

4

3

2

1

THIS DRAWING IS UNPUBLISHED.	RELEASED FOR PUBLICATION	20
© COPYRIGHT 20 BY -	ALL RIGHTS RESERVED.	

LOC	DIST	REVISIONS					
ES	00	P	LTR	DESCRIPTION	DATE	DWN	APVD

△ 9 SPECIAL VERSION WITHOUT PEG FEATURE.

OTHER DIMENSIONS SEE SHEET 1, PCB LAYOUT SEE SHEET 1

15		1		15	2362614-5	△ 8
14		1		14	2362614-4	△ 8
13		1		13	2362614-3	△ 8
12		1		12	2362614-2	△ 8
11		1		11	2362614-1	△ 8
10		1		10	2350434-0	△ 8
9	TAB CONTACT w/ TIN PLATING	1	RAST 2.5 TAB HEADER HOUSING EXTERNAL LOCKING WITHOUT PEG TBD ON DETAIL LAYOUT	9	2350434-9	△ 8
8		1		8	2350434-8	△ 8
7		1		7	2350434-7	△ 8
6		1		6	2350434-6	△ 8
5		1		5	2350434-5	△ 8
4		1		4	2350434-4	△ 8
3		1	RAST 2.5 TAB HEADER HOUSING, EXTERNAL LOCKING, 3P WITHOUT PEG (SEE THE DETAIL LAYOUT ON SHEET 5)	3	2350434-3	△ 8
QTY	TAB CONTACT	QTY	HOUSING	POS.	TE PART NO.	△ 5

THIS DRAWING IS A CONTROLLED DOCUMENT.		DWN	12NOV2012	 TE Connectivity
DIMENSIONS:		CHK	12NOV2012	
mm		APVD	12NOV2012	
TOLERANCES UNLESS OTHERWISE SPECIFIED:		PRODUCT SPEC		
0 PLC ±		NAME	RAST 2.5 TAB HEADER ASSY TH, VERTICAL, EXTERNAL LOCKING	
1 PLC ±		SIZE	A2	
2 PLC ±0.20		CAGE CODE	00779	
3 PLC ±		DRAWING NO	C-1971817	
4 PLC ±		RESTRICTED TO		
ANGLES ±°		WEIGHT	-	
FINISH		CUSTOMER DRAWING	SCALE	5:1
			SHEET	4 OF 6
			REV	A18

1471-9 (3/11)

C

B

A

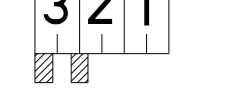

7-1971817-3

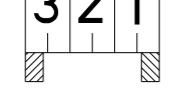

9-1971817-3



9-1971837-3

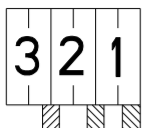

8-1971817-3

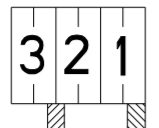

1971817-3



1971837-3

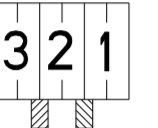

1-2335894-3

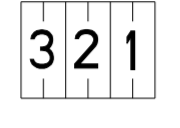

2335894-3



2350434-3



4-1971817-4

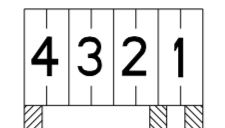

5-1971817-4



5-1971837-4

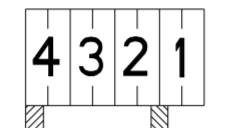

6-1971817-4



6-1971837-4

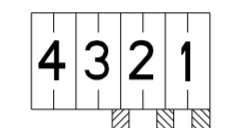

7-1971817-4



7-1971837-4



4-1971817-5

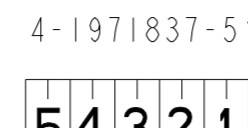

6-1971817-5



6-1971837-5

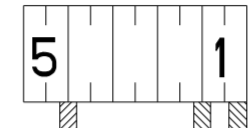

7-1971817-5



7-1971837-5

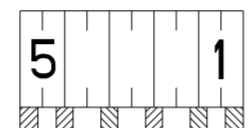

5-1971817-5



8-1971817-5



9-1971817-5



4-1971817-6



4-1971837-6



4-1971817-7



4-1971837-7



5-1971817-7



5-1971837-7



6-1971817-7



6-1971837-7



7-1971817-7



7-1971837-7



3-1971817-8



3-1971837-8

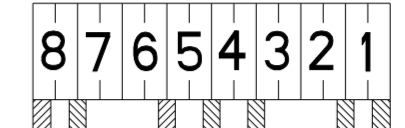

5-1971817-8



5-1971837-8

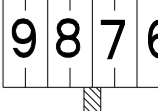

4-1971817-9

4-1971837-9

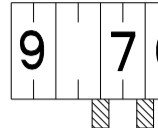

5-1971817-9

5-1971837-9

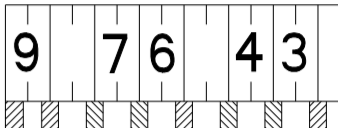

6-1971817-9

6-1971837-9

3 POS

4 POS

5 POS

6 POS

7 POS

8 POS

9 POS

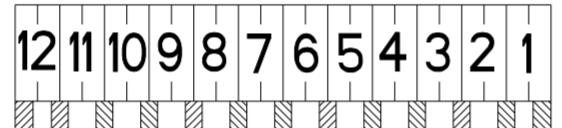

1-1971818-2



1-1971838-2

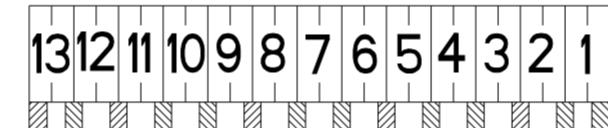

1-1971818-3



1-1971838-3

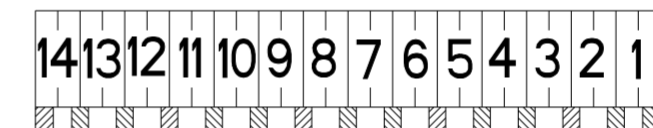

1-1971818-4



1-1971838-4

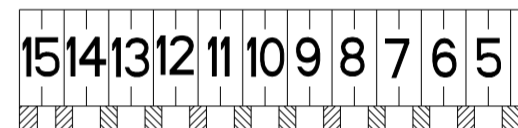

1-1971818-5



1-1971838-5



1-1971818-1

1-2367449-1



1-1971838-1



2-1971818-2



2-1971838-2

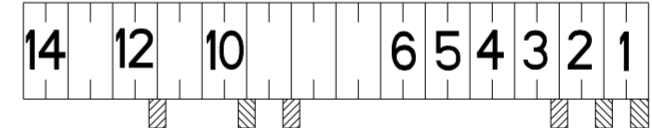

2-1971818-4



2-1971838-4

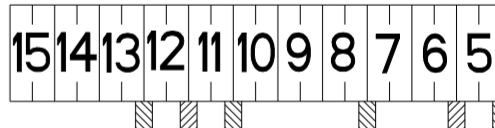

2-1971818-5



2-1971838-5

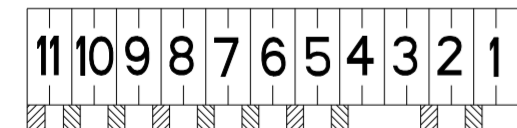

2-1971818-1

2-1971838-1

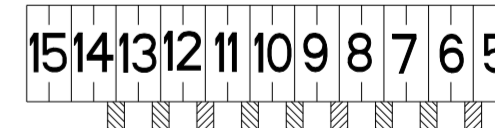

3-1971818-5

3-1971838-5

11 POS

12 POS

13 POS

14 POS

15 POS

THIS DRAWING IS UNPUBLISHED. RELEASED FOR PUBLICATION 20
 © COPYRIGHT 20 BY - ALL RIGHTS RESERVED.

LOC	DIST	REVISIONS			
ES	00	P	LTR	DESCRIPTION	DATE
					DWN
					APVD

FOR ANY KEYING CONFIGURATION, THERE ARE EIGHT COLORS AVAILABLE, BESIDES THE NATURAL COLOR, THERE ARE OTHER SEVEN COLORS, INCLUDE: YELLOW, BLUE, GREY, PURPLE, RED, GREEN, BLACK. THE WHITE VERSION IS PRELIMINARY. THE P/N OF THE COLOR CONNECTOR ARE BASED ON THE NATURAL CONNECTOR, THE PREFIX AND POSTFIX ARE THE SAME FOR THE SAME KEYING CONFIGURATION, BUT THE BASE NUMBERS ARE DIFFERENT ACCORDING TO DIFFERENT COLOR. THE FOLLOWING SHOWS WHAT'S THE P/N FOR COLOR CONNECTOR

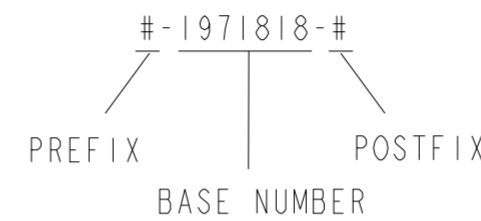

COLOR	PART NUMBER OF THE CONNECTOR				COMMENTS
	WITH TIN PLATING CONTACT		WITH AG PLATING CONTACT		
NATURAL	#-1971817-#	#-1971818-#	#-1971837-#	#-1971838-#	THE DETAIL P/N FOR DIFFERENT KEYING SEE SHEET 2 & 3 & 4
RED	#-1971938-#	#-1971939-#	#-2232141-#	#-2232142-#	THE PREFIX AND POSTFIX ARE THE SAME WITH THE P/N OF THE NATURAL CONNECTOR FOR THE SAME KEYING CONFIGURATION, JUST THE BASE NUMBERS ARE DIFFERENT BASED ON DIFFERENT COLOR. # CAN BE THE NUMBER FROM 0 TO 9.
BLUE	#-2232143-#	#-2232144-#	#-2232145-#	#-2232146-#	
YELLOW	#-2232147-#	#-2232148-#	#-2232149-#	#-2232150-#	
BALCK	#-1971994-#	#-1971995-#	#-2232151-#	#-2232152-#	
GREY	#-1971976-#	#-1971977-#	#-2232153-#	#-2232154-#	
GREEN	#-1971988-#	#-1971989-#	#-2232155-#	#-2232156-#	
PURPLE	#-2232157-#	#-2232158-#	#-2232159-#	#-2232160-#	
WHITE	#-2232277-#	#-2232278-#	#-2232279-#	#-2232280-#	

FOR EXAMPLE, IF A CONNECTOR WITH THE CONFIGURATION AS BELOW, AND WITH TIN PLATING CONTACT, IN THE SHEET 4, WE CAN FIND THE RELATED CONNECTOR P/N WITH NATURAL COLOR IS 5-1971817-4, THEN WE CAN LOOK IN THE ABOVE TABLE TO FIND THE CONNECTOR P/N WITH RED COLOR IS 5-1971938-4

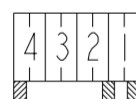

THIS DRAWING IS A CONTROLLED DOCUMENT.		DWN	12NOV2012	TE Connectivity
DIMENSIONS: mm		CHK	12NOV2012	
		TOLERANCES UNLESS OTHERWISE SPECIFIED:	APVD	
		0 PLC ± 1 PLC ± 2 PLC ±0.20 3 PLC ± 4 PLC ± ANGLES ±1° FINISH	YUHONG MAO	
MATERIAL		PRODUCT SPEC	108-106079	RAST 2.5 TAB HEADER ASSY TH, VERTICAL, EXTERNAL LOCKING
		APPLICATION SPEC		SIZE
		WEIGHT		CAGE CODE
		CUSTOMER DRAWING		DRAWING NO
				RESTRICTED TO
				A2 00779 C-1971817
				SCALE 5:1 SHEET 6 OF 6 REV A18

X-ON Electronics

Largest Supplier of Electrical and Electronic Components

Click to view similar products for [Headers & Wire Housings](#) category:

Click to view products by [TE Connectivity](#) manufacturer:

Other Similar products are found below :

[892-18-020-10-001101](#) [58102-G61-06LF](#) [582553-1](#) [0009485154](#) [009176003701906](#) [0050291907](#) [LY20-4P-DT1-P1E-BR](#) [02.125.8002.8](#)
[609-3404](#) [61062-3](#) [61082-181009](#) [622-3653LF](#) [63453-116](#) [636-1030](#) [636-1427](#) [636-3427](#) [636-4007](#) [641938-9](#) [641991-4](#) [644827-2](#) [65817-](#)
[010LF](#) [65817-015LF](#) [65863-015LF](#) [66207-023LF](#) [67095-007LF](#) [67601157](#) [68645-018](#) [68648-049](#) [70.362.1628.0](#) [70-4210](#) [70-4226B](#) [70-](#)
[4853B](#) [707-5020](#) [707-5028](#) [71.350.2428.0](#) [71918-208LF](#) [71961-016LF](#) [733-134](#) [733-162](#) [754199-000](#) [760-3052](#) [787-8014-00](#) [79531-3000](#)
[FCN-360C032-B](#) [FCN-367T-T012/H](#) [FCN-723D010/2](#) [80.063.4001.1](#) [800-90-001-10-001000](#) [800-90-010-10-002000](#) [801-43-002-10-013000](#)