

LOC	DIST	REVISIONS					
ES	00	P	LTN	DESCRIPTION	DATE	DWN	APVD
		A23	ECR-17-013299		11SEP2017	WW	RR
		A24	ECR-18-008274		30MAY2018	KD	FL
		A25	ECR-19-012819		16AUG2019	SM	FL

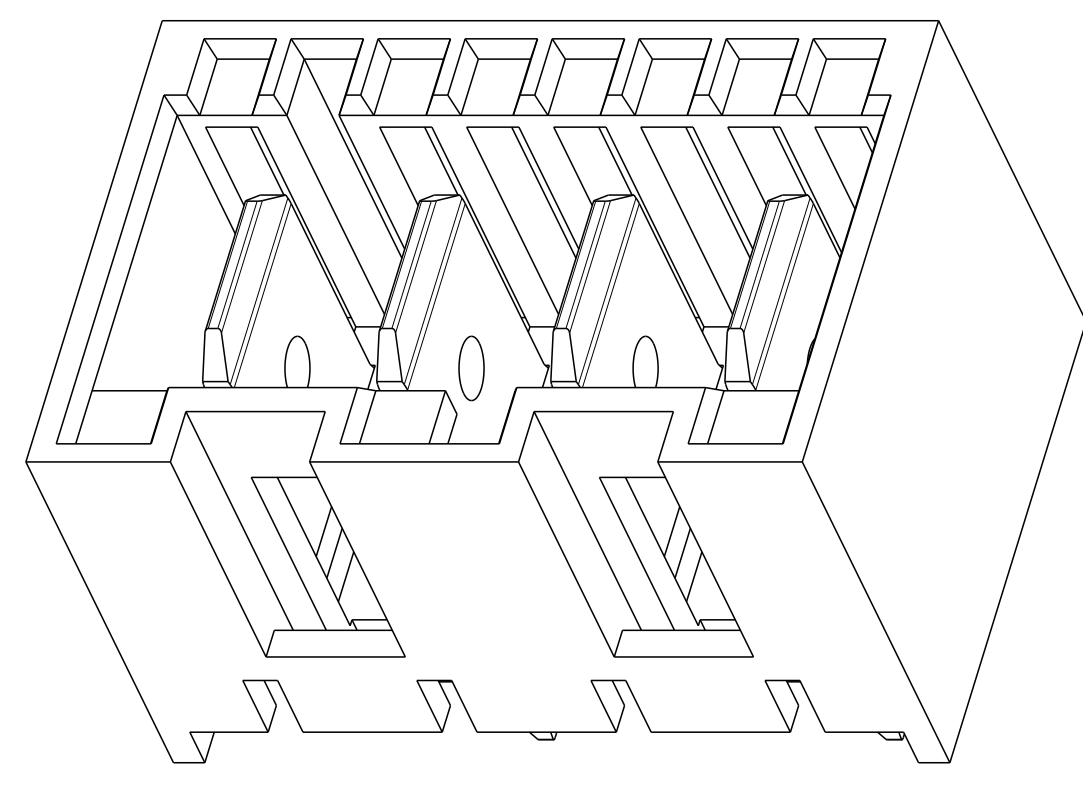

**NOTE**

- 1 HOUSING HAS RAST 5 COMPLIANT KEYING, LATCHING, AND POLARIZATION TAB IS 6.30 X 0.8 ACCORDING TO DIN 46244
- 2 SEE SHEET 2 FOR AVAILABLE CONFIGURATIONS
- 3 MATERIAL: HOUSING, NYLON, UL94 V0, 750°C GWT NO FLAME CONTACT, COPPER ALLOY, 0.8MM THICK
- 4 FINISH: CONTACTS, MATT TIN PLATING OVERALL, NICKEL UNDER-PLATING BRIGHT TIN PLATING OVERALL, NICKEL UNDER-PLATING SILVER PLATING OVERALL, NICKEL UNDER-PLATING
- 5 PCB TABS INSERTED IN A STAGGERED PATTERN BEGINNING WITH POSITION 1 (Cct1)
- 6 THE PART NUMBERS SHOWING IN SHEET 2 & 3 & 4 & 5 ARE FOR NATURAL COLOR. THE PART NUMBER FOR OTHER COLOR ARE BASED ON THE NATURAL ONE: FOR THE SAME CONFIGURATION, THE PREFIX AND POSTFIX OF THE P/N ARE THE SAME, ONLY THE BASE NUMBER IS DIFFERENT ACCORDING TO DIFFERENT COLOR, DETAIL PLEASE SEE SHEET 6
- 7 PACKAGING: LOOSE PIECE OR TUBE. THE PART NUMBERS IN THIS DRAWING ARE WITH LOOSE PIECE PACKAGING. PLEASE CONTACT TE SALES REPRESENTATIVES FOR TUBE PACKAGING REQUIREMENT.
- 8 PRELIMINARY PART, NOT RELEASED FOR PRODUCTION.
- 9 FOR P/N: 2-1971895-4:
  - 1) THE CONTACTS ARE WITH BRIGHT TIN PLATING
  - 2) INSERTION FORCE MATING WITH 4P MONO SHAPE MKI CONNECTOR: 85N MAX ACCORDING TO IEC 60512-13-1, Test 13a.
- 10 FOR P/N: 5-1971845-8, 2-1971845-6, 6-1971845-5 AND 2-1971895-5:
  - 1) THE CONTACTS ARE WITH BRIGHT TIN PLATING.
- 11 PART NUMBERS WITH TUBE PACKAGING

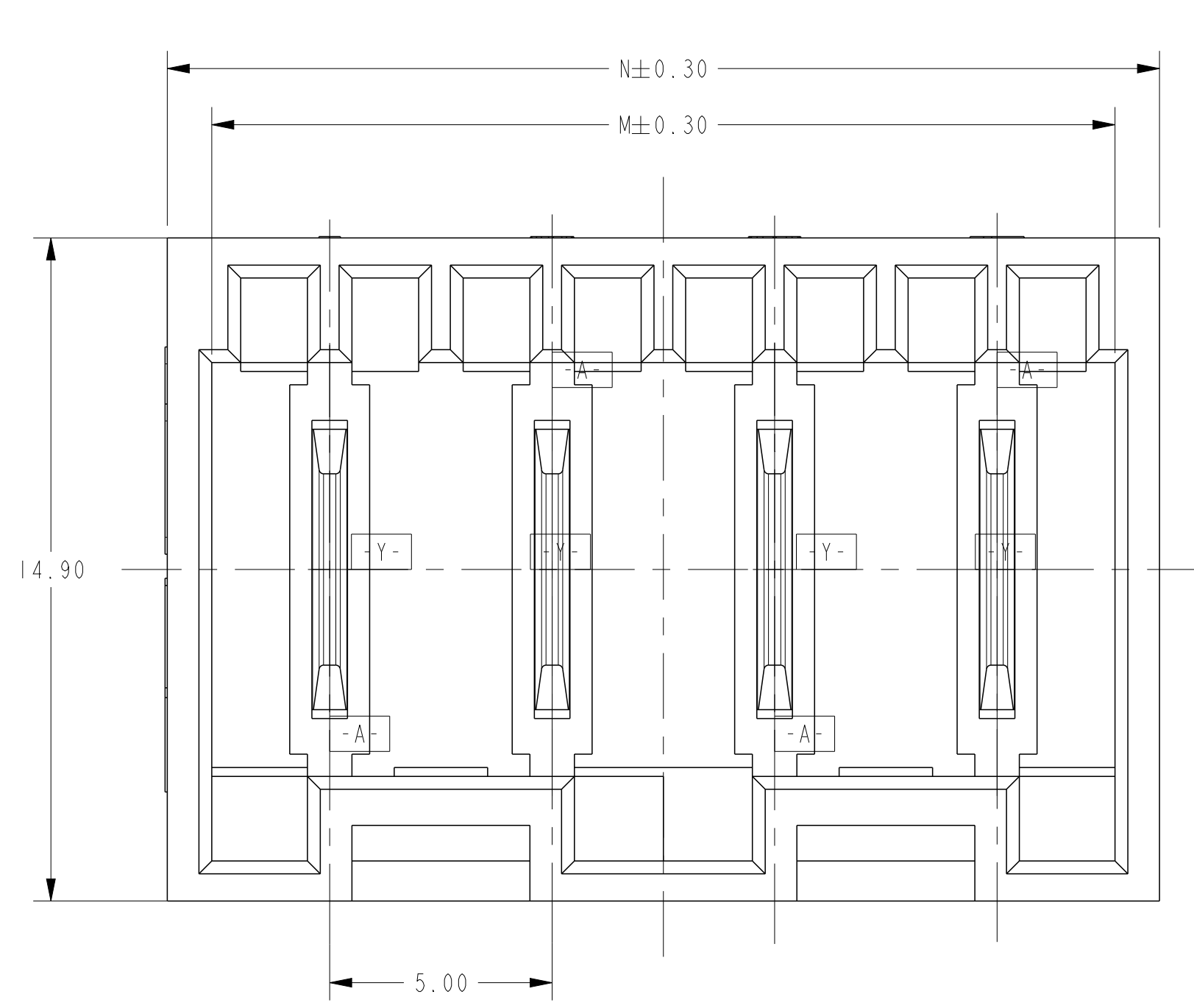
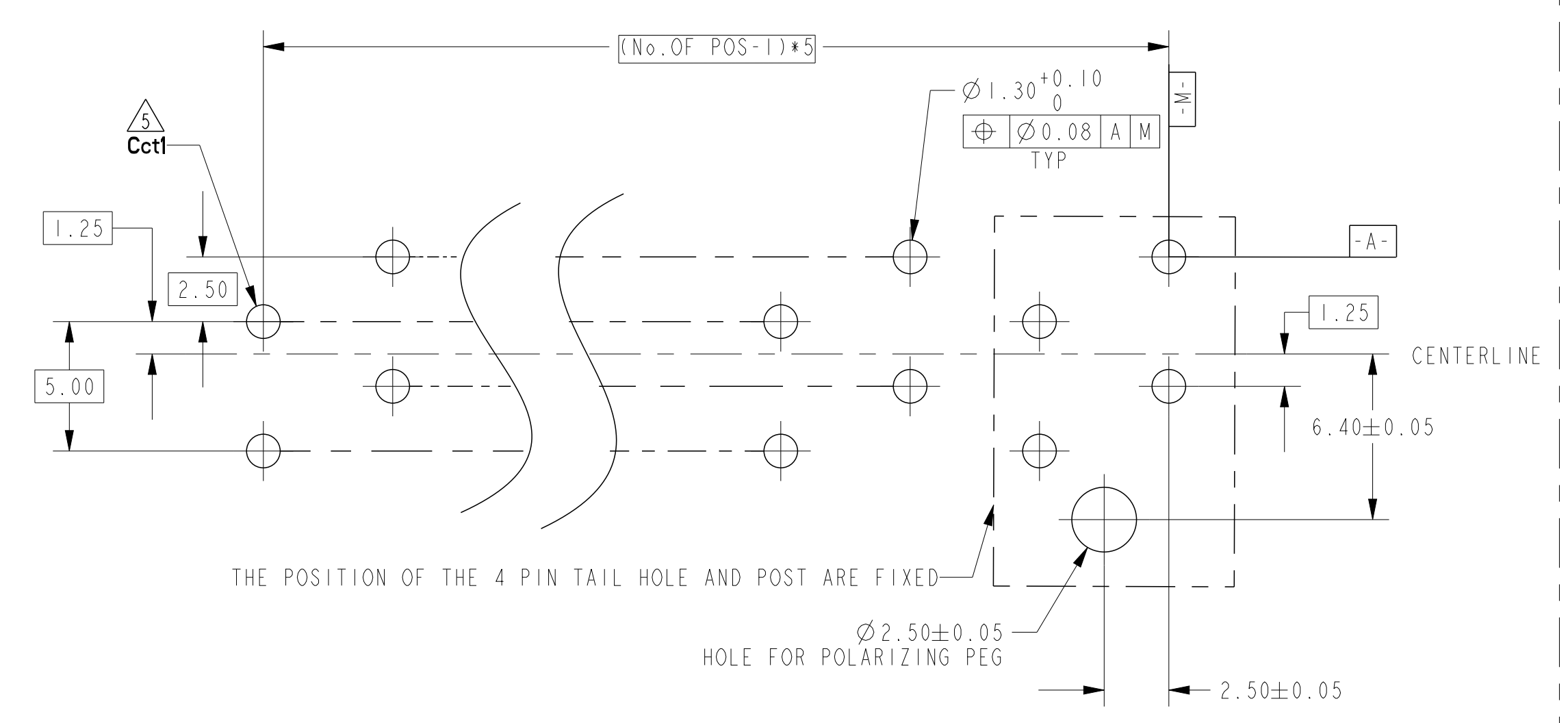
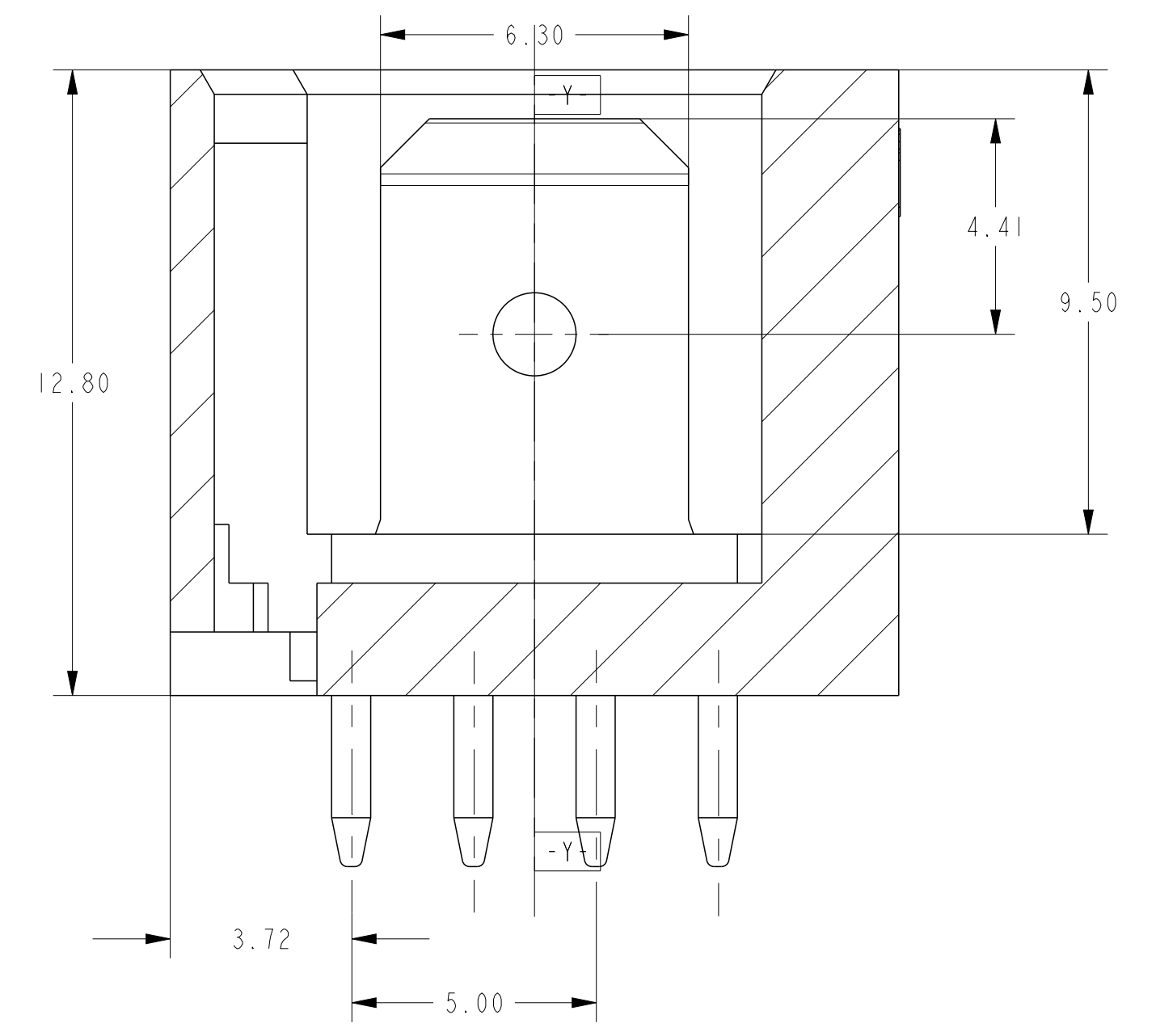
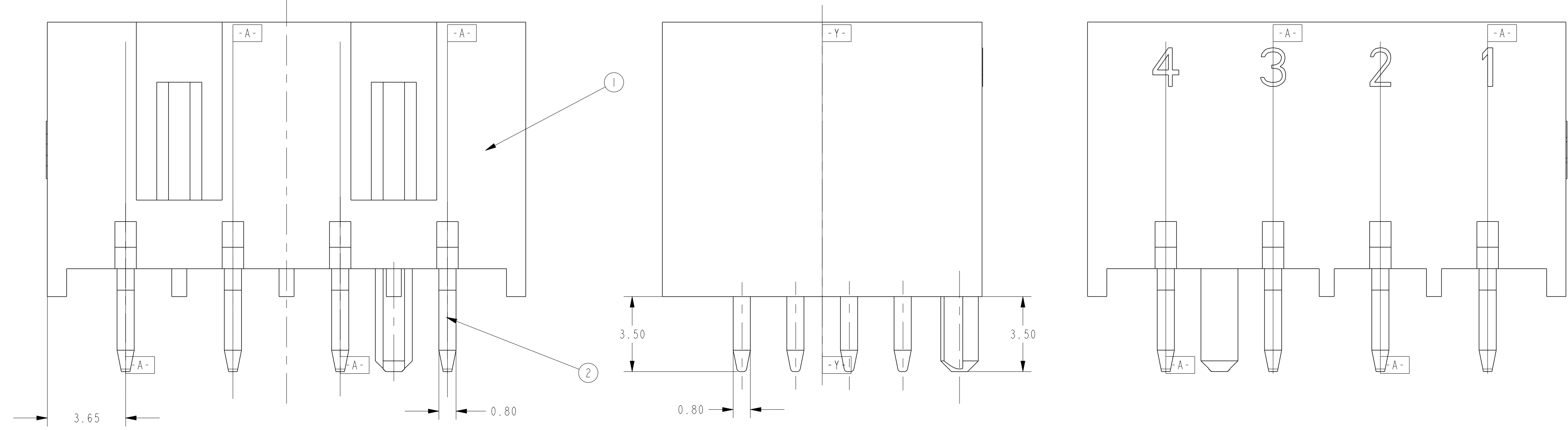

RECOMMEND PCB LAYOUT - SOLDER SIDE  
 EVEN NUMBER OF PINS  
 PCB 15±0.2 THICK

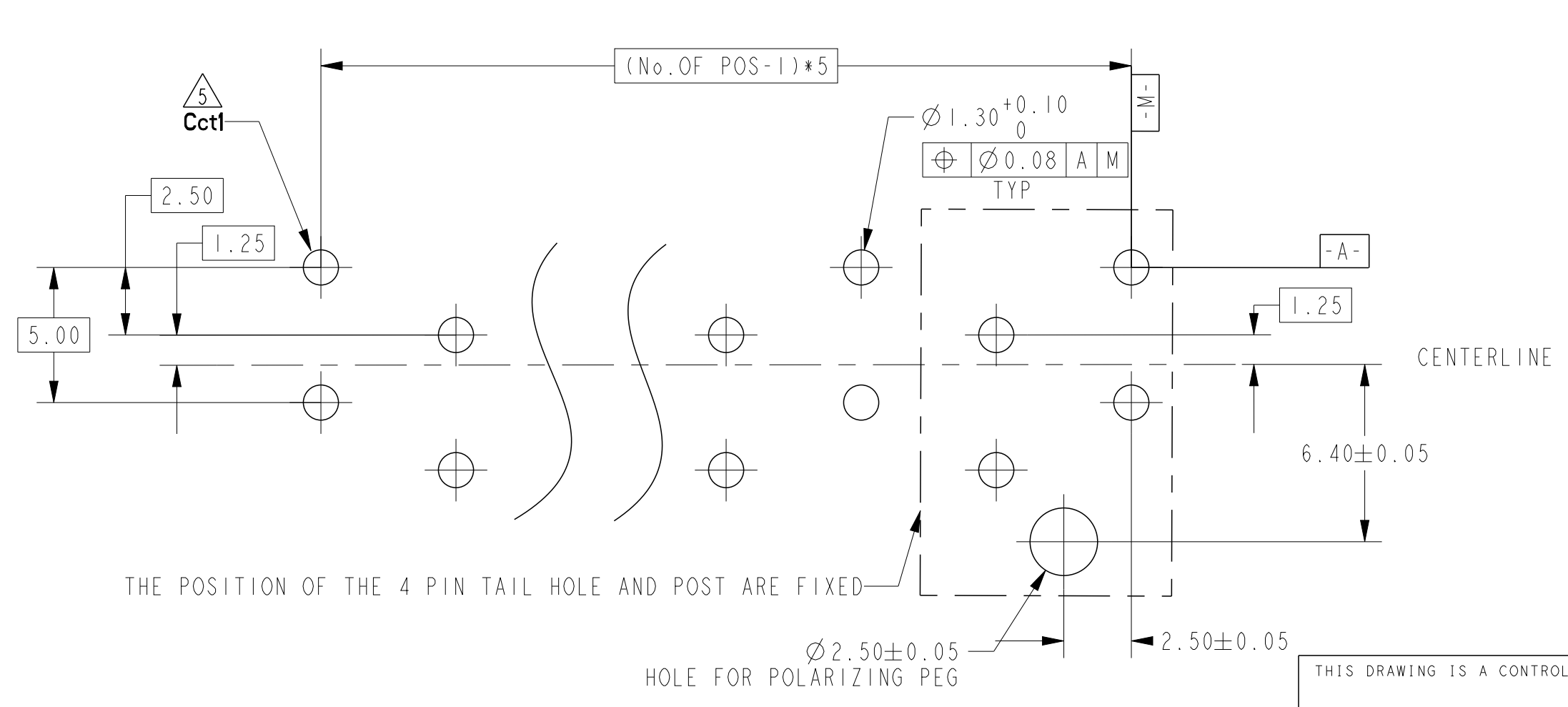

RECOMMEND PCB LAYOUT - SOLDER SIDE  
 ODD NUMBER OF PINS  
 PCB 15±0.2 THICK

42.30	40.30	8
37.30	35.30	7
32.30	30.30	6
27.30	25.30	5
22.30	20.30	4
17.30	15.30	3
12.30	10.30	2
N	M	NO. OF POS.

THIS DRAWING IS A CONTROLLED DOCUMENT.

DIMENSIONS:	TOLERANCES UNLESS OTHERWISE SPECIFIED:	DWN: HRP 21Jan2013	CHK: HAPYE 21Jan2013	APVD: YHM 21Jan2013
mm	0 PLC ±	NAME: RAST 5 TAB HEADER ASSY		
	1 PLC ±	DIN STYLE, TH, VERTICAL		
	2 PLC ±0.25	SIZE: A1		
	3 PLC ±	CAGE CODE: 00779		
	4 PLC ±	DRAWING NO: 1971845		
	ANGLES ±2°	SHEET 1 OF 6		
MATERIAL:	FINISH:	SCALE: 8:1		
		REV: A25		

Customer Drawing

LOC	DIST	REVISONS	DATE	OWN	APVD
		P LTR	DESCRIPTION		
		-	SEE SHEET 1	-	-

color	QTY	②	QTY	①	NO. OF POS.	TE PART NO.		
NATURAL	8	TAB CONTACT MATT TIN PLATING (5-1971845-8, 6-1971845-5, 2-1971845-6 AND 2-1971895-5 WITH BRIGHT TIN)	1	8	8	6-1971845-8 5-1971845-8 $\Delta_{10}$ 4-1971845-8 3-1971845-8 2-1971845-8 1-1971845-8 1971845-8		
RED	7		1	7	7	1971946-7 1971895-7 9-1971845-7 8-1971845-7 7-1971845-7 6-1971845-7 5-1971845-7 4-1971845-7 3-1971845-7 2-1971845-7 1-1971845-7 1971845-7		
NATURAL			1	6	6	1-1971895-6 1971895-6 9-1971845-6 8-1971845-6 7-1971845-6 6-1971845-6 5-1971845-6 4-1971845-6 3-1971845-6 2-1971845-6 $\Delta_{10}$ 1-1971845-6 1971845-6		
BLUE			5	1	5	5	1971954-5 $\Delta_{8}$ 2-1971895-5 $\Delta_{10}$ 1-1971895-5 1971895-5 9-1971845-5 8-1971845-5 7-1971845-5 6-1971845-5 $\Delta_{10}$ 5-1971845-5 4-1971845-5 3-1971845-5 2-1971845-5 1-1971845-5 1971845-5	
NATURAL				1	4	4	5-1971895-3 4-1971895-3 3-1971895-3 2-1971895-3 1-1971895-3 1971895-3 9-1971845-3 8-1971845-3 7-1971845-3 6-1971845-3 5-1971845-3 4-1971845-3 3-1971845-3 2-1971845-3 1-1971845-3 1971845-3	
NATURAL				4	3	3	3	7-1971895-2 6-1971895-2 5-1971895-2 4-1971895-2 3-1971895-2 2-1971895-2 1-1971895-2 1971895-2 9-1971845-2 8-1971845-2 7-1971845-2 6-1971845-2 5-1971845-2 4-1971845-2 3-1971845-2 2-1971845-2 1-1971845-2 1971845-2
NATURAL				2	2	2	2	1971895-4 2298030-4 9-1971895-4 8-1971895-4 $\Delta_{8}$ 7-1971895-4 6-1971895-4 5-1971895-4 4-1971895-4 3-1971895-4 2-1971895-4 $\Delta_{9}$ 1-1971895-4 1971895-4 $\Delta_{1}$ 9-2304591-4 9-1971845-4 8-1971845-4 7-1971845-4 6-1971845-4 5-1971845-4 4-1971845-4 3-1971845-4 2-1971845-4 1-1971845-4 1971845-4
NATURAL				4	1	1	1	1971962-4

color	QTY	②	QTY	①	NO. OF POS.	TE PART NO.
GREEN	4	TAB CONTACT w/ MATT TIN PLATING (2-1971895-4 IS WITH BRIGHT TIN)	1	4	4	1971962-4 2298030-4 9-1971895-4 8-1971895-4 $\Delta_{8}$ 7-1971895-4 6-1971895-4 5-1971895-4 4-1971895-4 3-1971895-4 2-1971895-4 $\Delta_{9}$ 1-1971895-4 1971895-4 $\Delta_{1}$ 9-2304591-4 9-1971845-4 8-1971845-4 7-1971845-4 6-1971845-4 5-1971845-4 4-1971845-4 3-1971845-4 2-1971845-4 1-1971845-4 1971845-4
natural	3		1	3	3	5-1971895-3 4-1971895-3 3-1971895-3 2-1971895-3 1-1971895-3 1971895-3 9-1971845-3 8-1971845-3 7-1971845-3 6-1971845-3 5-1971845-3 4-1971845-3 3-1971845-3 2-1971845-3 1-1971845-3 1971845-3
natural	2		1	2	2	7-1971895-2 6-1971895-2 5-1971895-2 4-1971895-2 3-1971895-2 2-1971895-2 1-1971895-2 1971895-2 9-1971845-2 8-1971845-2 7-1971845-2 6-1971845-2 5-1971845-2 4-1971845-2 3-1971845-2 2-1971845-2 1-1971845-2 1971845-2
natural	3		1	3	3	1971895-4 2298030-4 9-1971895-4 8-1971895-4 $\Delta_{8}$ 7-1971895-4 6-1971895-4 5-1971895-4 4-1971895-4 3-1971895-4 2-1971895-4 $\Delta_{9}$ 1-1971895-4 1971895-4 $\Delta_{1}$ 9-2304591-4 9-1971845-4 8-1971845-4 7-1971845-4 6-1971845-4 5-1971845-4 4-1971845-4 3-1971845-4 2-1971845-4 1-1971845-4 1971845-4
natural	4		1	4	4	1971962-4 2298030-4 9-1971895-4 8-1971895-4 $\Delta_{8}$ 7-1971895-4 6-1971895-4 5-1971895-4 4-1971895-4 3-1971895-4 2-1971895-4 $\Delta_{9}$ 1-1971895-4 1971895-4 $\Delta_{1}$ 9-2304591-4 9-1971845-4 8-1971845-4 7-1971845-4 6-1971845-4 5-1971845-4 4-1971845-4 3-1971845-4 2-1971845-4 1-1971845-4 1971845-4

THIS DRAWING IS A CONTROLLED DOCUMENT.

OWN: HRP 21Jan2013  
CHK: HAPYE 21Jan2013  
APVD: YHM 21Jan2013

NAME: RAST 5 TAB HEADER ASSY  
DIN STYLE, TH, VERTICAL

SIZE: A1 CAGE CODE: 00779 DRAWING NO: 108-106080  
SCALE: 8:1 SHEET 2 OF 6

RESTRICTED TO: -

Customer Drawing

LOC	DIST	REVISONS	DATE	OWN	APVD
		P. LTR	DESCRIPTION		
		-	SEE SHEET 1	-	-

color	QTY	②	QTY	①	NO. OF POS.	TE PART NO.
NATURAL	8	1	1	8	8	6-1971846-8
						5-1971846-8
						4-1971846-8
						3-1971846-8
NATURAL	7	1	1	7	7	2-1971846-8
						1-1971846-8
						1971846-8
						1971896-7
						9-1971846-7
						8-1971846-7
						7-1971846-7
						6-1971846-7
						5-1971846-7
						4-1971846-7
NATURAL	6	1	1	6	6	3-1971846-7
						2-1971846-7
						1-1971846-7
						1971846-7
						1-1971896-6
						1971896-6
						9-1971846-6
						8-1971846-6
						7-1971846-6
						6-1971846-6
NATURAL	5	1	1	5	5	5-1971846-6
						4-1971846-6
						3-1971846-6
						2-1971846-6
						1-1971846-6
						1971846-6
						1971896-5
						9-1971846-5
						8-1971846-5
						7-1971846-5
6-1971846-5						
NATURAL	4	1	1	4	4	5-1971846-5
						4-1971846-5
						3-1971846-5
						2-1971846-5
						1-1971846-5
						1971846-5
						1971896-4
						9-1971846-4
						8-1971846-4
						7-1971846-4
6-1971846-4						
NATURAL	3	1	1	3	3	5-1971846-4
						4-1971846-4
						3-1971846-4
						2-1971846-4
						1-1971846-4
						1971896-3
						9-1971846-3
						8-1971846-3
						7-1971846-3
						6-1971846-3
NATURAL	2	1	1	2	2	5-1971846-3
						4-1971846-3
						3-1971846-3
						2-1971846-3
						1-1971846-3
						1971846-3
						6-1971896-2
						5-1971896-2
						4-1971896-2
						3-1971896-2
2-1971896-2						
NATURAL	1	1	1	1	1	1-1971896-2
						1971896-2
						9-1971846-2
						8-1971846-2
						7-1971846-2
						6-1971846-2
						5-1971846-2
						4-1971846-2
						3-2304599-2
						3-1971846-2
2-1971846-2						
1-1971846-2						
1971846-2						

color	QTY	②	QTY	①	NO. OF POS.	TE PART NO.
NATURAL	4	1	1	4	4	1-2298031-4
						9-1971896-4
						7-1971896-4
						6-1971896-4
NATURAL	3	1	1	3	3	5-1971896-4
						4-1971896-4
						3-1971896-4
						2-1971896-4
						1-1971896-4
						1971896-4
						9-1971846-4
						8-1971846-4
						7-1971846-4
						6-1971846-4
NATURAL	2	1	1	2	2	5-1971846-4
						4-1971846-4
						3-1971846-4
						2-1971846-4
						1-1971846-4
						1971846-4
						4-1971896-3
						3-1971896-3
						2-1971896-3
						1-1971896-3
NATURAL	1	1	1	1	1	1971896-3
						9-1971846-3
						8-1971846-3
						7-1971846-3
						6-1971846-3
						5-1971846-3
						4-1971846-3
						3-1971846-3
						2-1971846-3
						1-1971846-3
NATURAL	1	1	1	1	1	1971846-3
						6-1971896-2
						5-1971896-2
						4-1971896-2
						3-1971896-2
						2-1971896-2
						1-1971896-2
						1971896-2
						9-1971846-2
						8-1971846-2
7-1971846-2						
6-1971846-2						
5-1971846-2						
4-1971846-2						
3-2304599-2						
3-1971846-2						
2-1971846-2						
1-1971846-2						
1971846-2						

THIS DRAWING IS A CONTROLLED DOCUMENT.		OWN: HRP 21Jan2013	 TE Connectivity NAME: RAST 5 TAB HEADER ASSY DIN STYLE, TH, VERTICAL
DIMENSIONS: mm		CHK: HAPYE 21Jan2013	
TOLERANCES UNLESS OTHERWISE SPECIFIED:		APVD: YHM 21Jan2013	
0 PLC ± 1 PLC ± 2 PLC ±0.25 3 PLC ± 4 PLC ± ANGLES ± FINISH ±		PRODUCT SPEC: 108-106080 APPLICATION SPEC: SIZE: A1 CAGE CODE: 00779 DRAWING NO: 1971845 RESTRICTED TO:	
MATERIAL: -	WEIGHT: -	Customer Drawing	SCALE: 8:1 SHEET 3 OF 6 REV: A25

LOC		DIST		REVISIONS				
P	LTN	DESCRIPTION	DATE	OWN	APVD			
-	-	SEE SHEET 1	-	-	-			

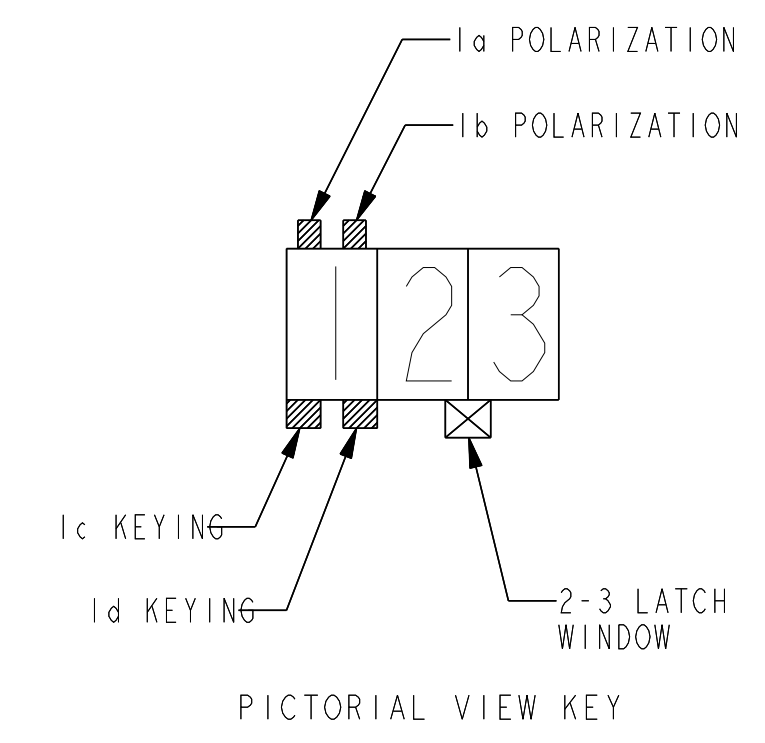

THIS DRAWING IS A CONTROLLED DOCUMENT.		OWN: HRP 21Jan2013	TE Connectivity
DIMENSIONS: mm		CHK: HAPYE 21Jan2013	
TOLERANCES UNLESS OTHERWISE SPECIFIED:		APVD: YHM 21Jan2013	NAME: RAST 5 TAB HEADER ASSY DIN STYLE, TH, VERTICAL
0 PLC ±		PRODUCT SPEC: 108-106080	
1 PLC ±0.25		APPLICATION SPEC:	SIZE: A1 CAGE CODE: 00779 DRAWING NO: 1971845
2 PLC ±		RESTRICTED TO:	
3 PLC ±		Customer Drawing	SCALE: 8:1
4 PLC ±			SHEET: 4 OF 6
ANGLES ±			REV: A25
FINISH ±			

LOC		DIST		REVISIONS				
P	LTN	DESCRIPTION			DATE	OWN	APVD	
-	-	SEE SHEET 1			-	-	-	

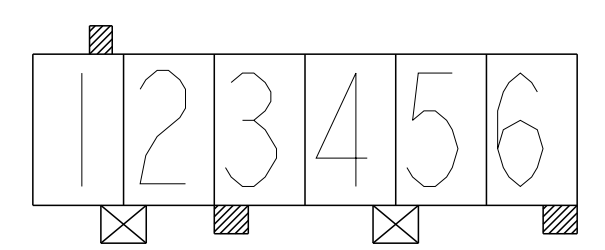

1971845-6  
1971846-6

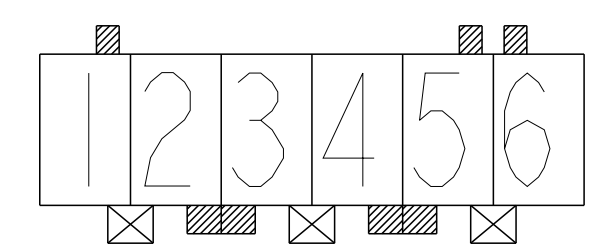

1971895-6  
1971896-6

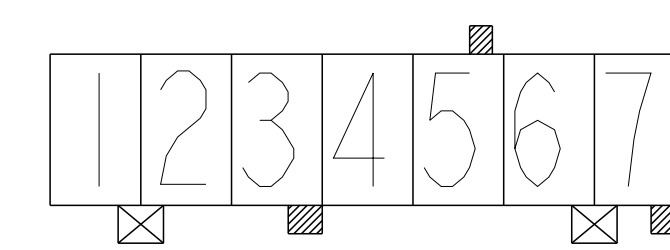

1971845-7  
1971846-7

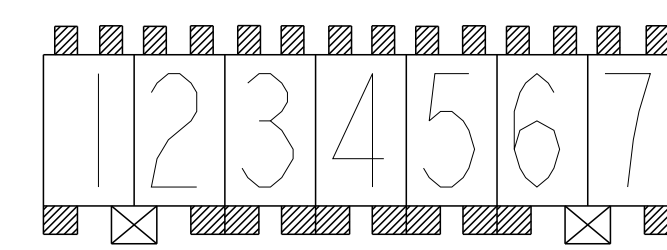

1971895-7  
1971896-7

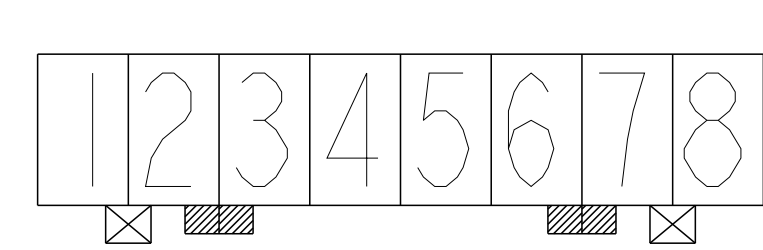

1971845-8  
1971846-8

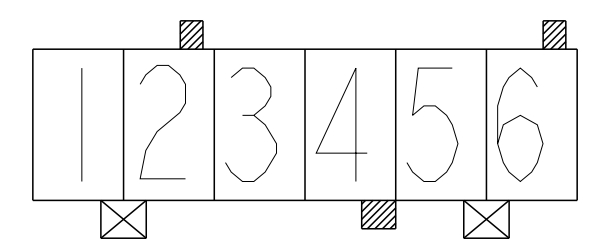

1-1971845-6  
1-1971846-6

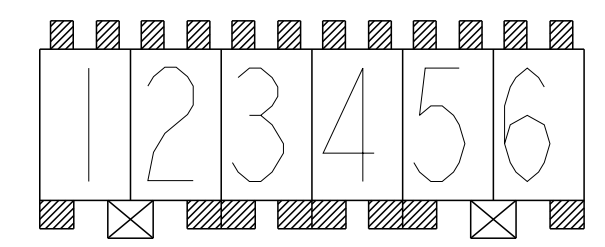

1-1971895-6  
1-1971896-6

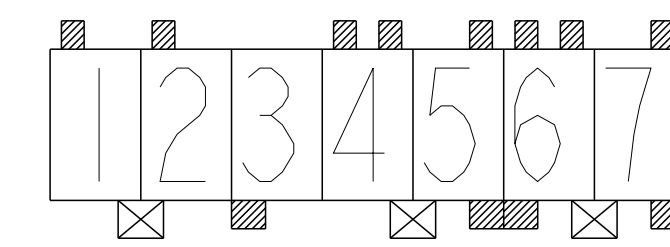

1-1971845-7  
1-1971846-7

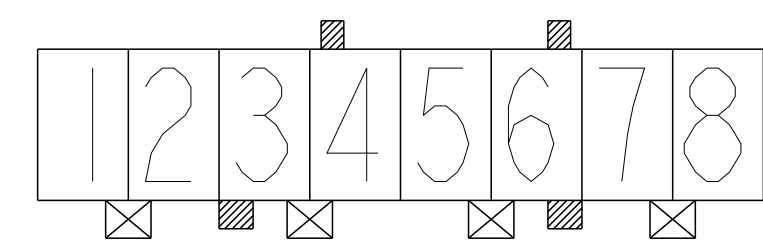

1-1971845-8  
1-1971846-8

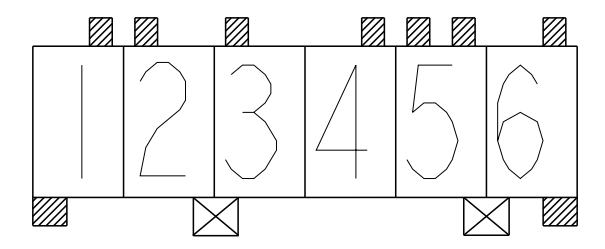

2-1971845-6  
2-1971846-6

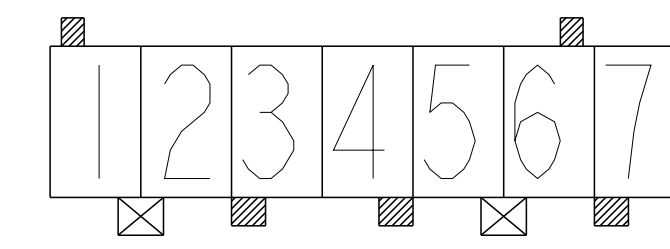

2-1971845-7  
2-1971846-7

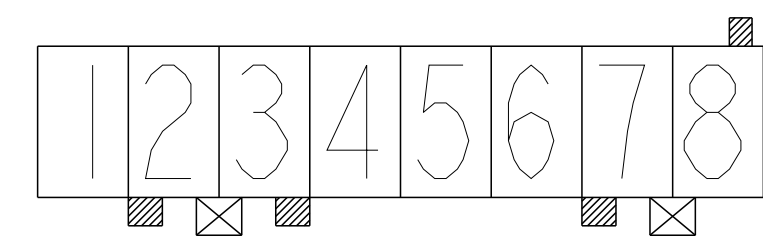

2-1971845-8  
2-1971846-8

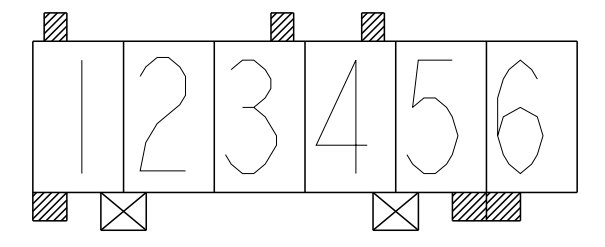

3-1971845-6  
3-1971846-6

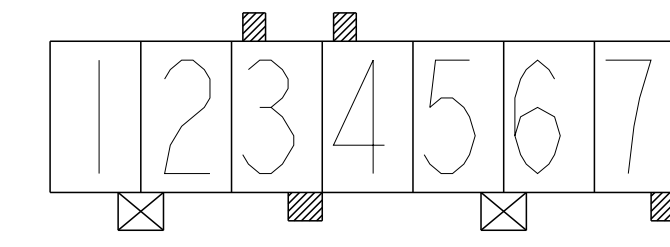

3-1971845-7  
3-1971846-7

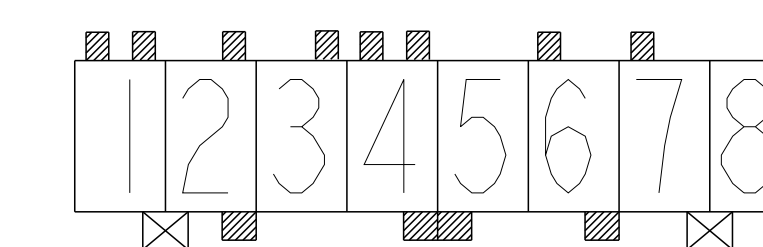

3-1971845-8  
3-1971846-8

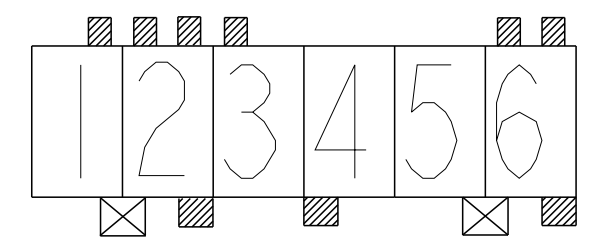

4-1971845-6  
4-1971846-6

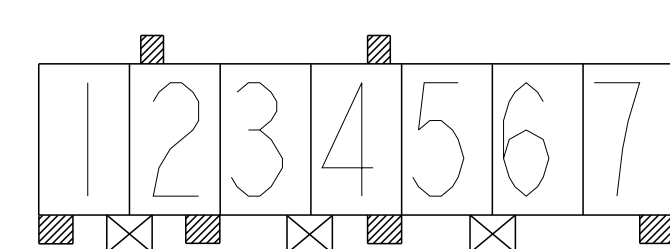

4-1971845-7  
4-1971846-7

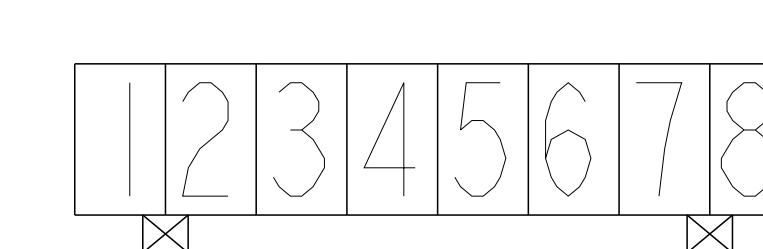

4-1971845-8  
4-1971846-8

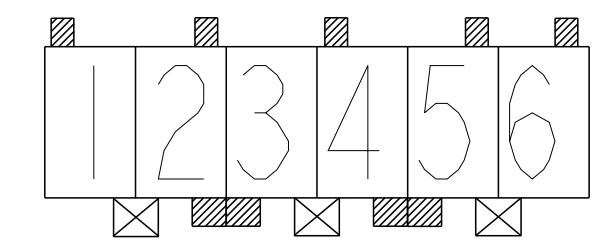

5-1971845-6  
5-1971846-6

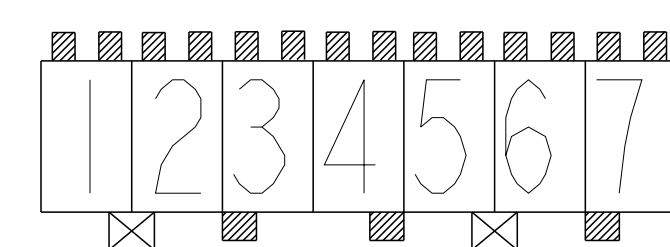

5-1971845-7  
5-1971846-7

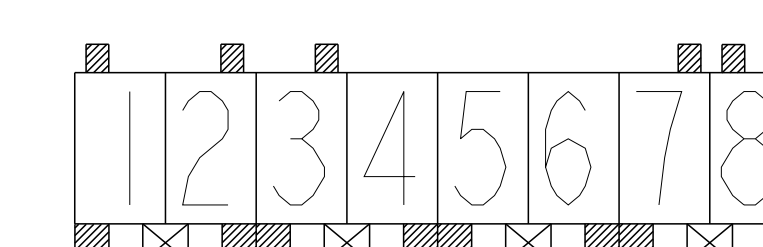

5-1971845-8  
5-1971846-8

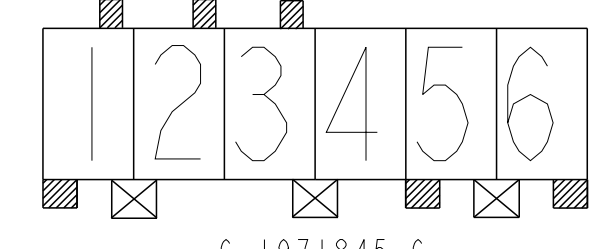

6-1971845-6  
6-1971846-6

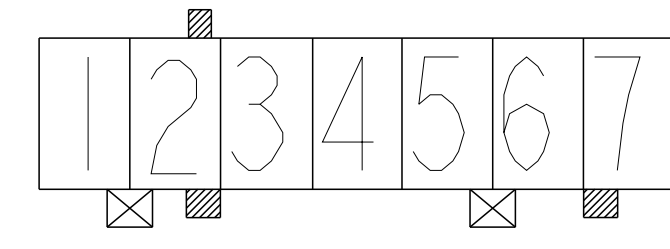

6-1971845-7  
1971946-7  
6-1971846-7

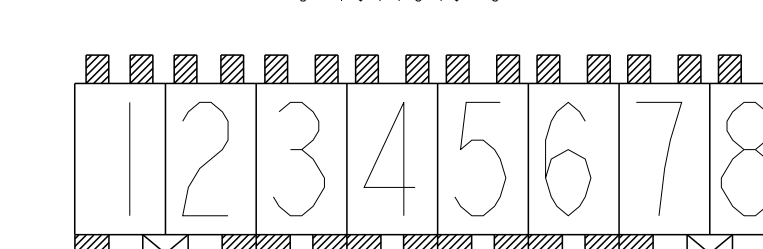

6-1971845-8  
6-1971846-8

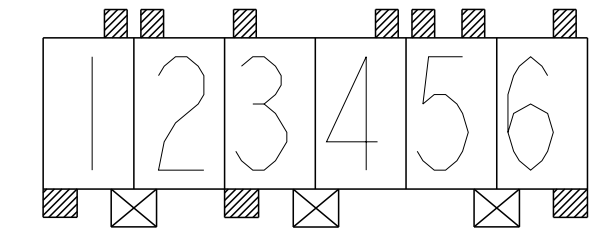

7-1971845-6  
7-1971846-6

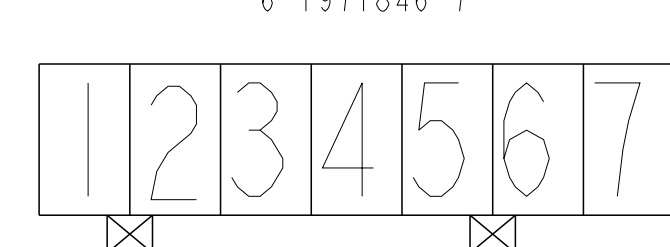

7-1971845-7  
7-1971846-7

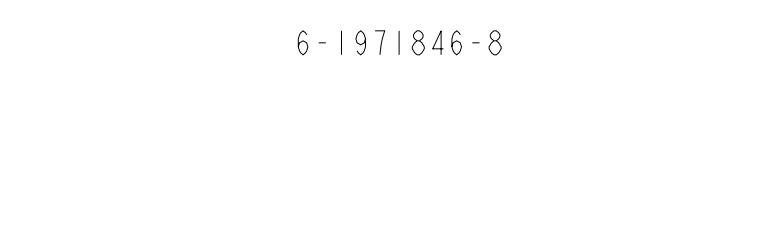

6-1971845-8  
6-1971846-8

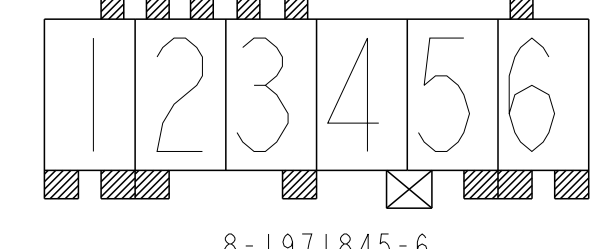

8-1971845-6  
8-1971846-6

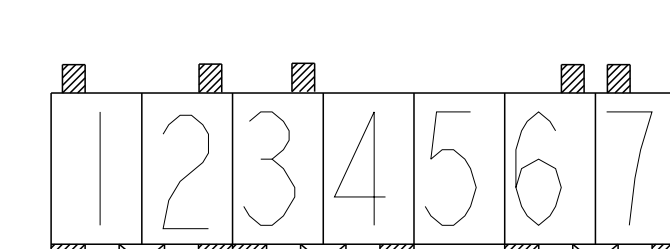

8-1971845-7  
8-1971846-7



6-1971845-8  
6-1971846-8

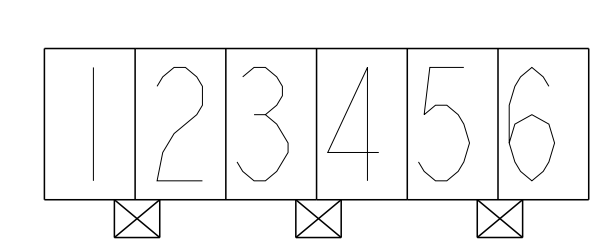

9-1971845-6  
9-1971846-6

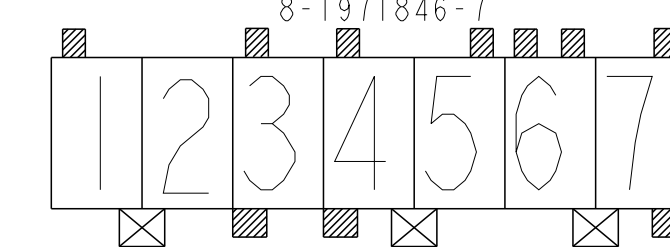

9-1971845-7  
9-1971846-7

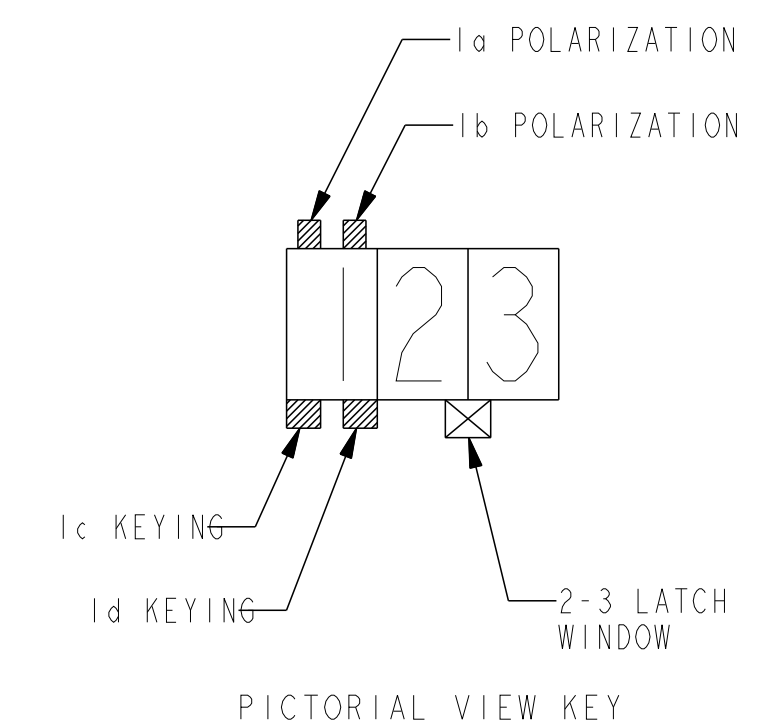

THIS DRAWING IS A CONTROLLED DOCUMENT.		OWN: WRP 21Jan2013	TE Connectivity
DIMENSIONS: mm		CHK: HAPYE 21Jan2013	
TOLERANCES UNLESS OTHERWISE SPECIFIED: 0 PLC ± 1 PLC ± 2 PLC ±0.25 3 PLC ± 4 PLC ± ANGLES ±2° FINISH		APVD: YHM 21Jan2013	NAME: RAST 5 TAB HEADER ASSY DIN STYLE, TH, VERTICAL
MATERIAL: -		PRODUCT SPEC: 108-106080	SIZE: A1
WEIGHT: -		APPLICATION SPEC: -	CAGE CODE: 00779
Customer Drawing		SCALE: 8:1	DRAWING NO: 1971845
		SHEET: 5 of 6	REV: A25

LOC		DIST		REVISIONS			
P	LTN	DESCRIPTION	DATE	DMN	APVD		
-	-	SEE SHEET 1	-	-	-		

FOR ANY KEYING CONFIGURATION, THERE ARE EIGHT COLORS AVAILABLE, BESIDES THE NATURAL COLOR. THERE ARE OTHER SEVEN COLORS, INCLUDE: YELLOW, BLUE, GREY, PURPLE, RED, GREEN, BLACK. THE WHITE VERSION IS PRELIMINARY. THE P/N OF THE COLOR CONNECTOR ARE BASED ON THE NATURAL CONNECTOR. THE PREFIX AND POSTFIX ARE THE SAME FOR THE SAME KEYING CONFIGURATION, BUT THE BASE NUMBERS ARE DIFFERENT ACCORDING TO DIFFERENT COLOR. THE FOLLOWING SHOWS WHAT'S THE P/N FOR COLOR CONNECTOR

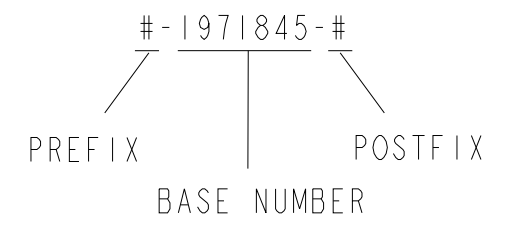

COLOR	PART NUMBER OF THE CONNECTOR				COMMENTS
	WITH MATT TIN PLATING CONTACT <small>(SPECIAL P/N: 2-1971895-4, 2-1971845-6, 6-1971845-5, 5-1971845-8 AND 2-1971895-5 ARE WITH BRIGHT TIN)</small>		WITH AG PLATING CONTACT		
NATURAL	#-1971845-#	#-1971895-#	#-1971846-#	#-1971896-#	THE DETAIL P/N FOR DIFFERENT KEYING SEE SHEET 2-5
RED	#-1971946-#	#-1971948-#	#-1971947-#	#-1971949-#	THE PREFIX AND POSTFIX ARE THE SAME WITH THE P/N OF THE NATURAL CONNECTOR FOR THE SAME KEYING, POLARIZATION, LATCH WINDOW CONFIGURATION. JUST THE BASE NUMBERS ARE DIFFERENT BASED ON DIFFERENT COLOR. # CAN BE THE NUMBER FROM 0 TO 9. BUT THERE ARE TWO EXEMPTION PART NUMBERS. 1971954-5 (BLUE) AND 1971946-7 (RED)
BLUE	#-1971954-#	#-1971956-#	#-1971955-#	#-1971957-#	
YELLOW	#-2232008-#	#-2232010-#	#-2232009-#	#-2232011-#	
BLACK	#-2232000-#	#-2232002-#	#-2232001-#	#-2232003-#	
GREY	#-2232016-#	#-2232018-#	#-2232017-#	#-2232019-#	
GREEN	#-1971962-#	#-1971964-#	#-1971963-#	#-1971965-#	
PURPLE	#-2232024-#	#-2232026-#	#-2232025-#	#-2232027-#	
WHITE	#-2232289-#	#-2232291-#	#-2232290-#	#-2232292-#	

THERE ARE TWO EXEMPTION FOR COLOR PART NUMBERS

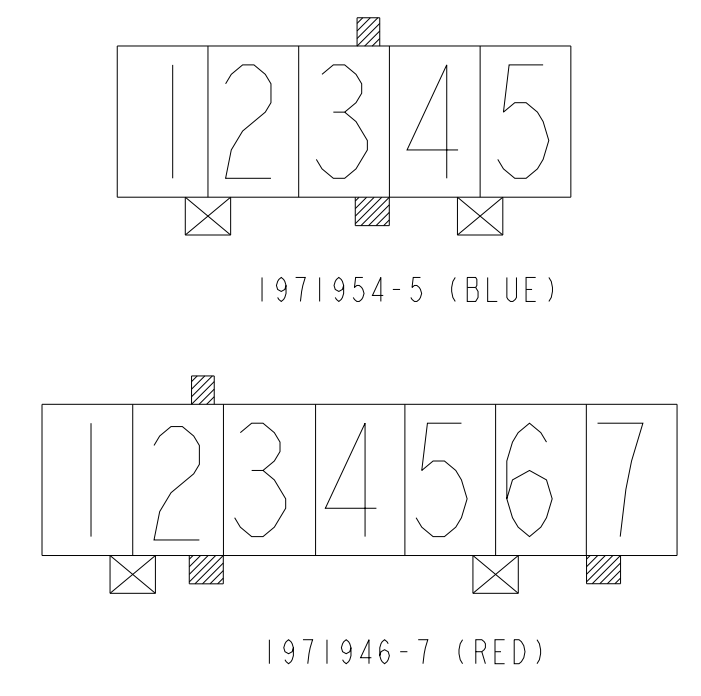

FOR EXAMPLE, IF A CONNECTOR WITH THE CONFIGURATION AS BELOW, AND WITH MATT TIN PLATING CONTACT, IN THE SHEET 4, WE CAN FIND THE RELATED CONNECTOR P/N WITH NATURAL COLOR IS 1-1971845-4, THEN WE CAN LOOK IN THE ABOVE TABLE TO FIND THE CONNECTOR P/N WITH RED COLOR IS 1-1971946-3

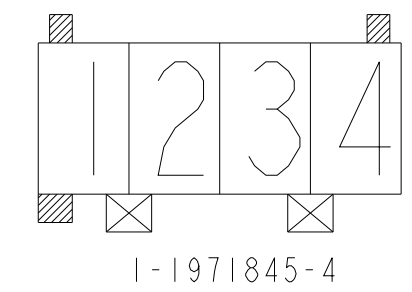

COLOR	PART NUMBER OF THE CONNECTOR		COMMENTS
	WITH BRIGHT TIN PLATING CONTACT		
NATURAL	#-2232906-#	#-2232907-#	THE KEYING, POLARIZATION AND LATCH WINDOW CONFIGURATION ARE SAME AS THE MATT TIN CONNECTOR WITH THE SAME PREFIX AND POSTFIX FOR EACH COLOR. FOR EXAMPLE: 2232906-4 AND 1971845-4 HAVE SAME KEYING, POLARIZATION AND LATCH WINDOW CONFIGURATION. 2232907-4 AND 1971895-4 HAVE SAME KEYING, POLARIZATION AND LATCH WINDOW CONFIGURATION. THE DETAIL KEYING, POLARIZATION AND LATCH WINDOW CONFIGURATION FOR EACH P/N, PLEASE SEE SHEET 2-5
RED	#-2232908-#	#-2232909-#	
BLUE	#-2232910-#	#-2232911-#	
YELLOW	#-2232912-#	#-2232913-#	
BLACK	#-2232914-#	#-2232915-#	
GREY	#-2232916-#	#-2232917-#	
GREEN	#-2232918-#	#-2232919-#	
PURPLE	#-2232920-#	#-2232921-#	
WHITE	#-2232922-#	#-2232923-#	

THIS DRAWING IS A CONTROLLED DOCUMENT.		DMN: HRP 21Jan2013	TE Connectivity NAME: RAST 5 TAB HEADER ASSY DIN STYLE, TH, VERTICAL
DIMENSIONS: mm		CHK: HAPYE 21Jan2013	
TOLERANCES UNLESS OTHERWISE SPECIFIED: 0 PLC ± 1 PLC ±0.25 2 PLC ± 3 PLC ± 4 PLC ± ANGLES FINISH ±2°		APVD: YHM 21Jan2013	
		PRODUCT SPEC: 108-106080 APPLICATION SPEC:	
MATERIAL: -	WEIGHT: -	SIZE: A1	CAGE CODE: 00779 DRAWING NO: C=1971845 RESTRICTED TO: -
Customer Drawing		SCALE: 8:1	SHEET: 6 OF 6 REV: A25

## X-ON Electronics

Largest Supplier of Electrical and Electronic Components

*Click to view similar products for [Headers & Wire Housings](#) category:*

*Click to view products by [TE Connectivity](#) manufacturer:*

Other Similar products are found below :

[95000-104TRLF](#) [10135584-644402LF](#) [DF62W-EP2022PCA](#) [95000-106TRLF](#) [DF62W-2022SCA](#) [DF62W-EP2022PC](#) [2203348](#) [DF62W-2022SC](#) [1084018](#) [1029039](#) [1084017](#) [802-10-012-10-002000](#) [1112640](#) [1112639](#) [000-34000](#) [0009482033](#) [0009507031](#) [57102-S06-03LF](#) [57202-S52-04LF](#) [PCN6-15S-2.5E](#) [0039019024](#) [58102-G61-06LF](#) [582553-1](#) [0009508121](#) [0050291907](#) [018731A](#) [LY20-4P-DT1-P1E-BR](#) [02.125.8002.8](#) [60101931](#) [60598-1 \(Cut Strip\)](#) [M1625-3R/100](#) [61062-3](#) [61082-181009](#) [636-1427](#) [638009-1](#) [641938-9](#) [641991-4](#) [644168-1](#) [647662-1](#) [65039-019ELF](#) [65817-002LF](#) [65817-015LF](#) [65863-015LF](#) [66207-023LF](#) [67016-026LF](#) [67046-001LF](#) [67095-007LF](#) [68002-116](#) [68016-236H](#) [68648-049](#)