

THIS DRAWING IS UNPUBLISHED. RELEASED FOR PUBLICATION 20
 © COPYRIGHT 20 BY - ALL RIGHTS RESERVED.

LOC		DIST		REVISIONS			
P	LTR	DESCRIPTION		DATE	DWN	APVD	
A6		ECR-15-016520		25NOV2015	SL	RR	
A7		ECR-17-001536		03FEB2017	IZ	RR	
A8		ECR-18-008584		05JUN2018	BW	LZ	
A9		ECR-18-009485		19MAY2019	BW	WW	

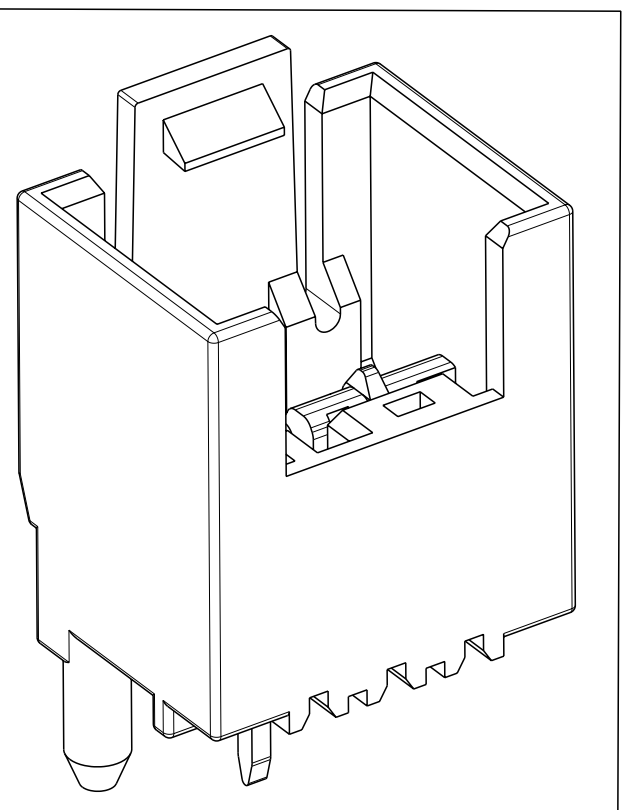
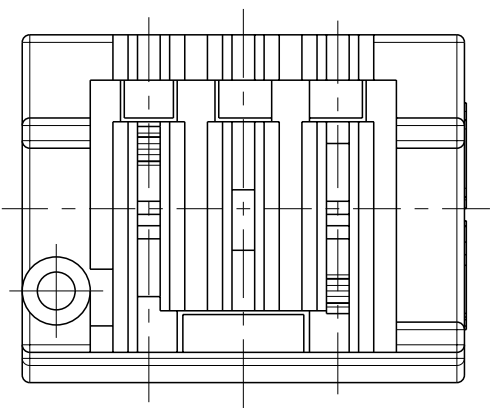
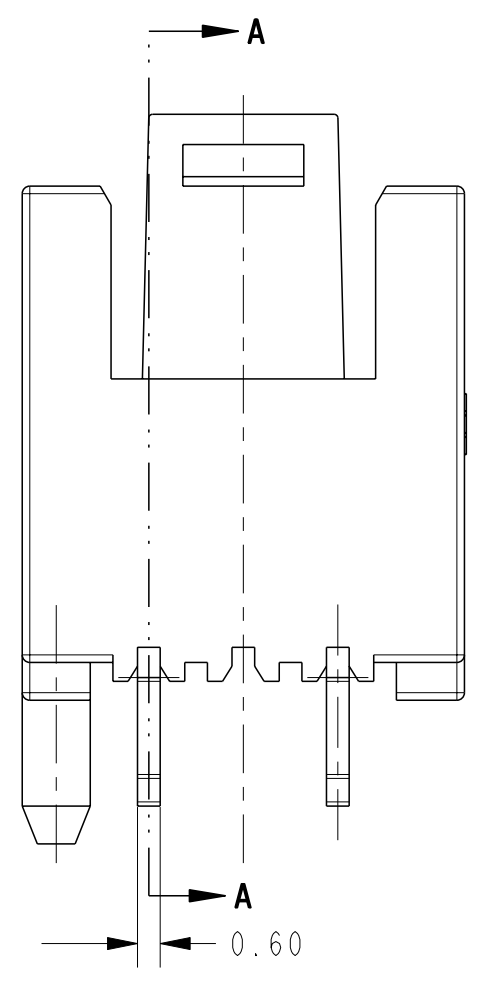
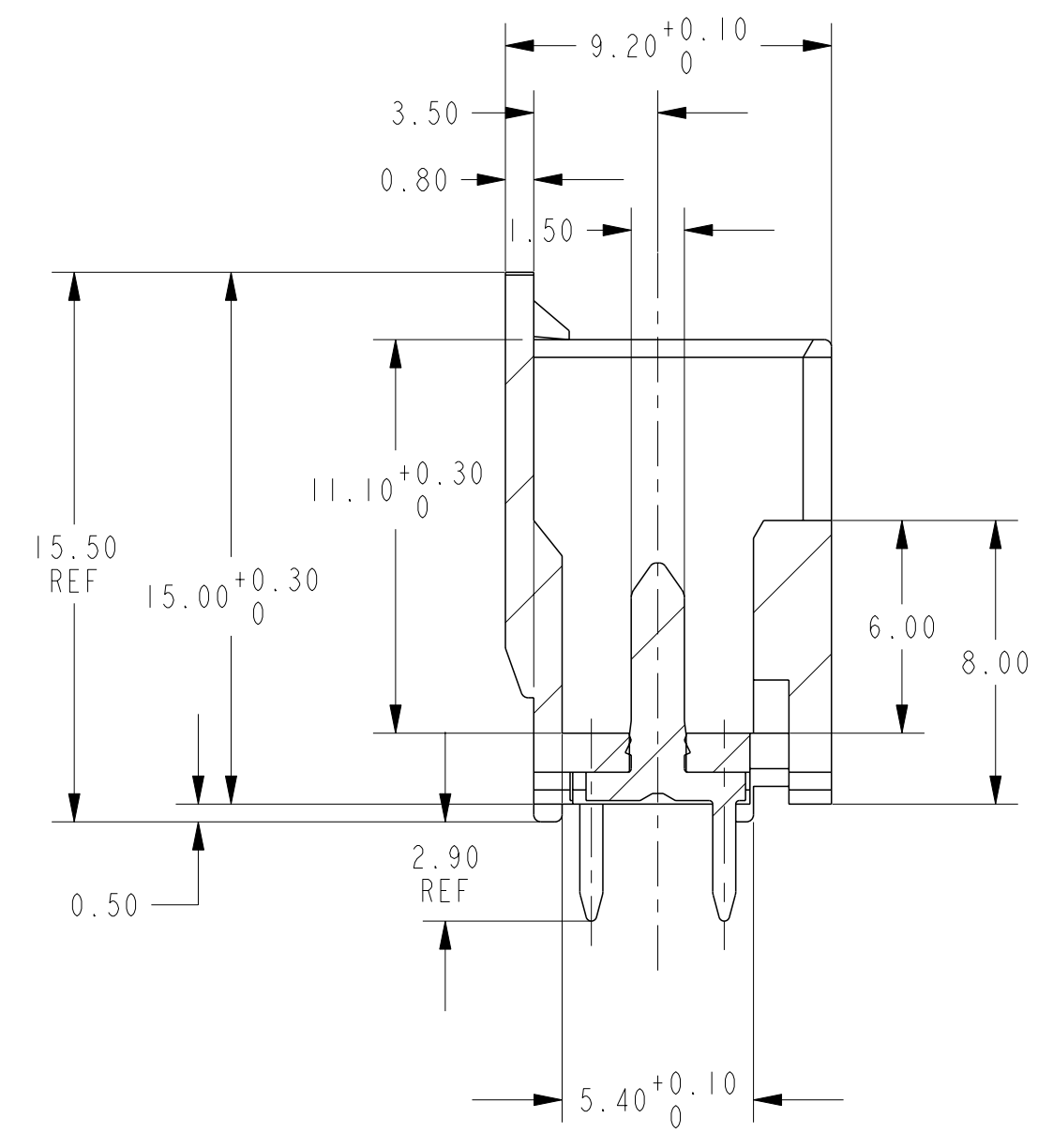
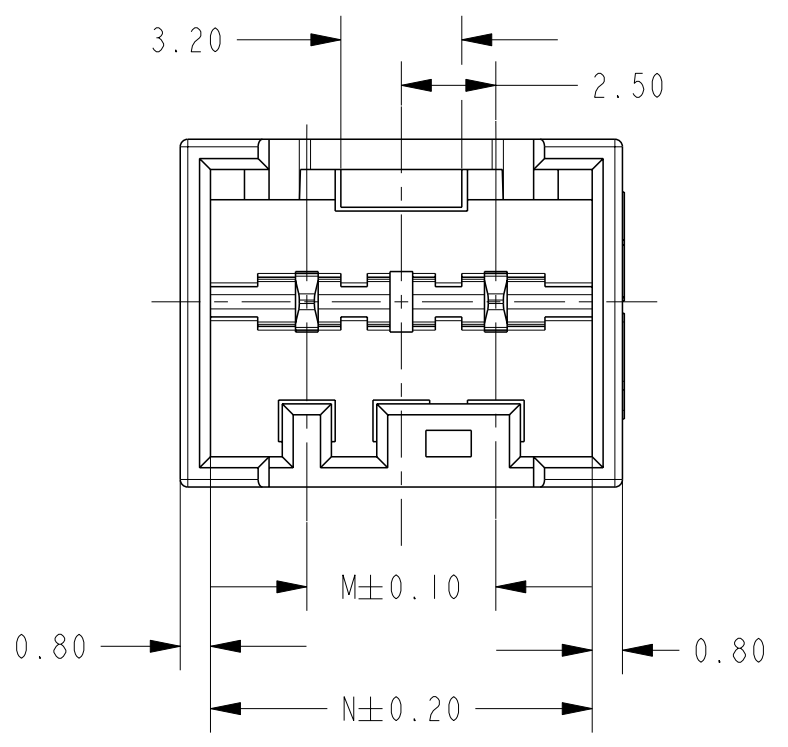

NOTE

- SEE SHEET 2 FOR AVAILABLE CONFIGURATIONS
- MATERIAL: HOUSING, NYLON, UL94 V0, 750°C GWT NO FLAME
EIGHT COLORS AVAILABLE, INCLUDING: NATURAL, RED, BLUE, YELLOW, BLACK, GREY, GREEN, PURPLE
WHITE VERSION IS PRELIMINARY

CONTACT, COPPER ALLOY, 0.60MM THICK
- FINISH: OPTION 1: TIN PLATING OVER NICKEL UNDERPLATING
OPTION 2: AG PLATING OVER NICKEL UNDERPLATING
- PCB LAYOUT AS SHOWN
- △ THE PART NUMBERS SHOWING IN SHEET 2 & 3 ARE FOR NATURAL COLOR. THE PART NUMBER FOR OTHER COLOR ARE BASED ON THE NATURAL ONE: FOR THE SAME CONFIGURATION, THE PREFIX AND POSTFIX OF THE P/N ARE THE SAME, ONLY THE BASE NUMBER IS DIFFERENT ACCORDING TO DIFFERENT COLOR, DETAIL PLEASE SEE SHEET 4
- PACKAGING: LOOSE PIECE OR TUBE. THE PART NUMBERS IN THIS DRAWING ARE WITH LOOSE PIECE PACKAGING. PLEASE CONTACT TE SALES REPRESENTATIVES FOR TUBE PACKAGING REQUIREMENT.
- △ PRELIMINARY PART NOT RELEASED FOR PRODUCTION

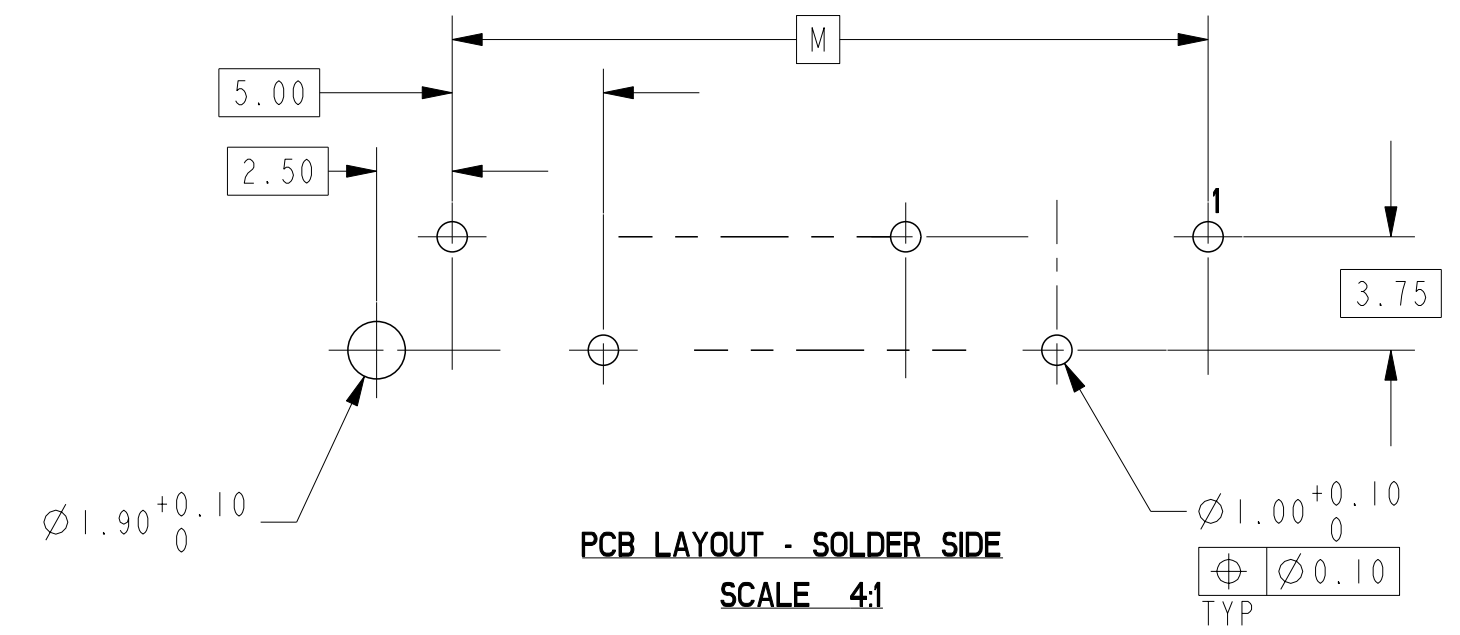

N	M	NO. OF POS.
40.10	35.00	8 LOAD, 15 POS.
35.10	30.00	7 LOAD, 13 POS.
30.10	25.00	6 LOAD, 11 POS.
25.10	20.00	5 LOAD, 9 POS.
20.10	15.00	4 LOAD, 7 POS.
15.10	10.00	3 LOAD, 5 POS.
10.10	5.00	2 LOAD, 3 POS.

THIS DRAWING IS A CONTROLLED DOCUMENT.

DWN	WINTER WANG	12NOV2012
CHK	HAPYE WU	12NOV2012
APVD	YUHQNG MAO	12NOV2012
PRODUCT SPEC	108-106079	
APPLICATION SPEC	-	
WEIGHT	-	
CUSTOMER DRAWING	-	

STE TE Connectivity

NAME: RAST 2.5 TAB HEADER ASSY, SELECTIVE LOADED, TH, VERTICAL, EXTERNAL LOCKING

SIZE	CAGE CODE	DRAWING NO	RESTRICTED TO
A2	00779	C-1971921	-

SCALE: NTS SHEET 1 OF 5 REV A9

THIS DRAWING IS UNPUBLISHED. RELEASED FOR PUBLICATION 20
 © COPYRIGHT 20 BY - ALL RIGHTS RESERVED.

LOC	DIST	REVISIONS					
ES	00	P	LTR	DESCRIPTION	DATE	DWN	APVD
		-		SEE SHEET 1	-	-	-

QTY	TAB CONTACT	QTY	HOUSING	POS.	TE PART NO.	
8	TAB CONTACT w/ SILVER PLATING	1	RAST 2.5 TAB HEADER HOUSING, EXTERNAL LOCKING, 15P (SEE THE DETAIL LAYOUT ON SHEET 3)	15	3-1971924-5 2-1971924-5 1-1971924-5	
7		1		13	1-1971924-3	
6		1		11	2-1971924-1 1-1971924-1	
5		1	RAST 2.5 TAB HEADER HOUSING, EXTERNAL LOCKING, 9P (SEE THE DETAIL LAYOUT ON SHEET 3)	9	6-1971923-9 5-1971923-9 4-1971923-9 3-1971923-9 2-1971923-9 1-1971923-9	
4		1		RAST 2.5 TAB HEADER HOUSING, EXTERNAL LOCKING, 7P (SEE THE DETAIL LAYOUT ON SHEET 3)	7	8-1971923-7 7-1971923-7 6-1971923-7 5-1971923-7 4-1971923-7 3-1971923-7 2-1971923-7 1-1971923-7
3		1			5	6-1971923-5 5-1971923-5 4-1971923-5 3-1971923-5 2-1971923-5 1-1971923-5
2		1			RAST 2.5 TAB HEADER HOUSING, EXTERNAL LOCKING, 3P (SEE THE DETAIL LAYOUT ON SHEET 3)	3

QTY	TAB CONTACT	QTY	HOUSING	POS.	TE PART NO.	
8	TAB CONTACT w/ TIN PLATING	1	RAST 2.5 TAB HEADER HOUSING, EXTERNAL LOCKING, 15P (SEE THE DETAIL LAYOUT ON SHEET 3)	15	3-1971922-5 2-1971922-5 1-1971922-5	
7		1		13	1-1971922-3	
6		1		11	2-1971922-1 1-1971922-1	
5		1	RAST 2.5 TAB HEADER HOUSING, EXTERNAL LOCKING, 9P (SEE THE DETAIL LAYOUT ON SHEET 3)	9	6-1971921-9 5-1971921-9 4-1971921-9 3-1971921-9 2-1971921-9 1-1971921-9	
4		1		RAST 2.5 TAB HEADER HOUSING, EXTERNAL LOCKING, 7P (SEE THE DETAIL LAYOUT ON SHEET 3)	7	8-1971921-7 7-1971921-7 6-1971921-7 5-1971921-7 4-1971921-7 3-1971921-7 2-1971921-7 1-1971921-7
3		1			5	9-1971921-5 8-1971921-5 7-1971921-5 6-1971921-5 5-1971921-5 4-1971921-5 3-1971921-5 2-1971921-5 1-1971921-5
2		1			RAST 2.5 TAB HEADER HOUSING, EXTERNAL LOCKING, 3P (SEE THE DETAIL LAYOUT ON SHEET 3)	3

THIS DRAWING IS A CONTROLLED DOCUMENT. 29MAY2012

DWN BOB YANG 12NOV2012	 TE Connectivity NAME RAST 2.5 TAB HEADER ASSY, SELECTIVE LOADED, TH, VERTICAL, EXTERNAL LOCKING			
CHK HAPYE WU 12NOV2012				
APVD YUHQNG MAO 12NOV2012				
PRODUCT SPEC				
APPLICATION SPEC	SIZE	CAGE CODE	DRAWING NO	RESTRICTED TO
WEIGHT	A2	00779	C-1971921	-
CUSTOMER DRAWING	SCALE	NTS	SHEET 2 OF 5	REV A9

DIMENSIONS: mm
 TOLERANCES UNLESS OTHERWISE SPECIFIED:
 0 PLC ±
 1 PLC ±
 2 PLC ±0.20
 3 PLC ±
 4 PLC ±
 ANGLES ±°
 FINISH

LOC	DIST	REVISIONS			
P	LYR	DESCRIPTION	DATE	OWN	APVD
-	-	SEE SHEET 1	-	-	-

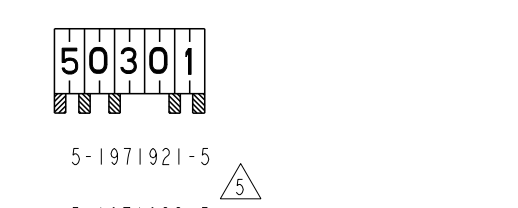
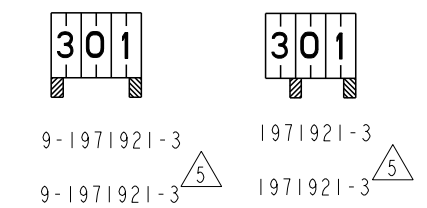
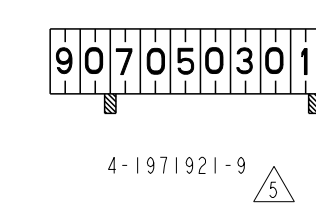
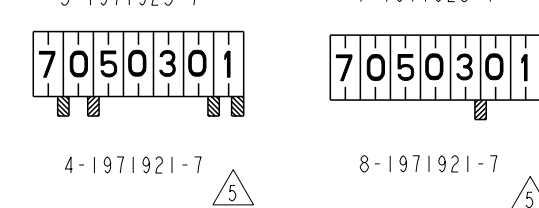
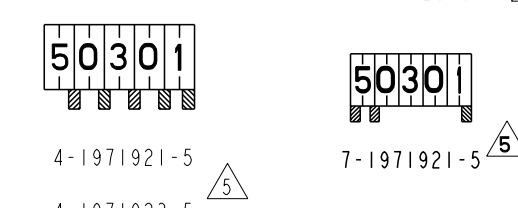
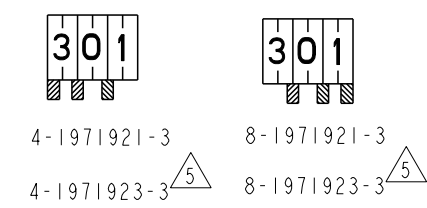
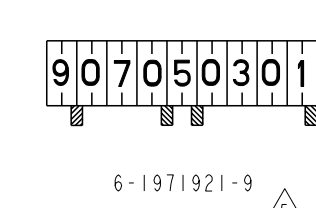
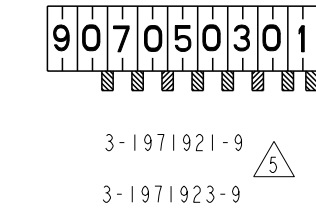
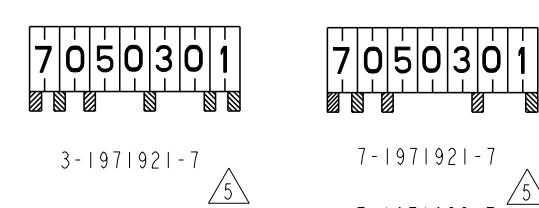
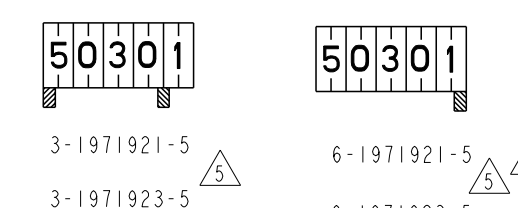
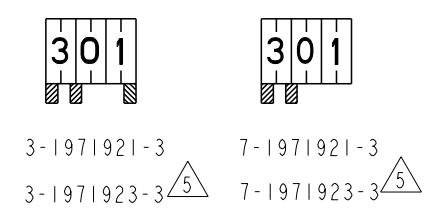
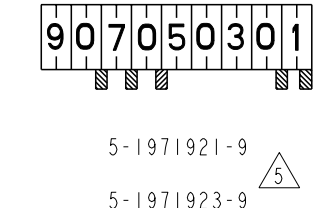
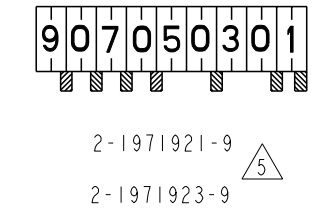
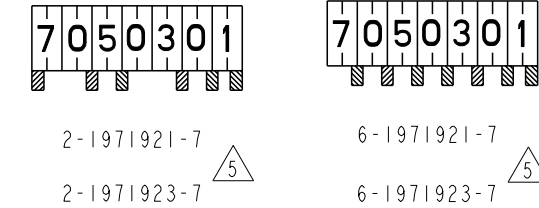
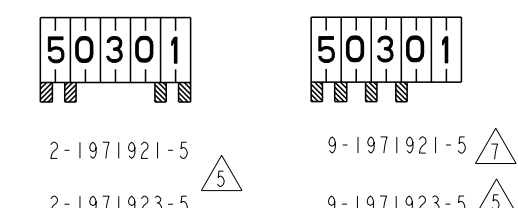
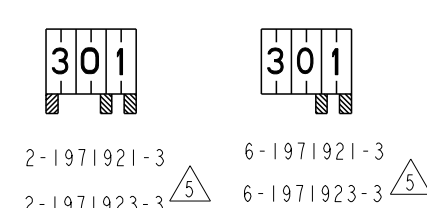
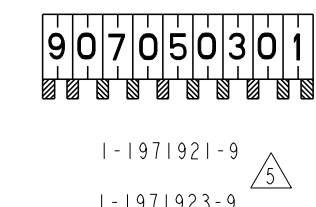
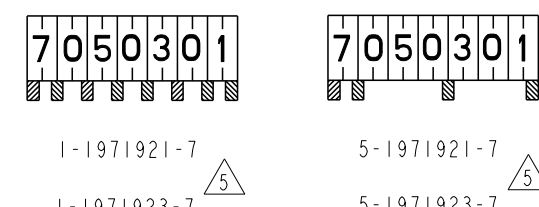
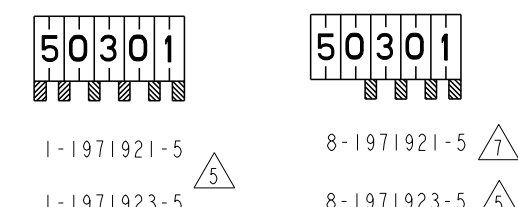
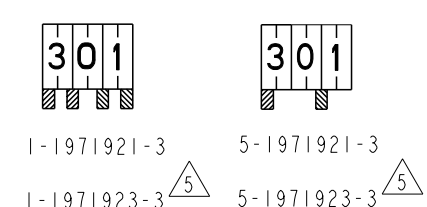

3 POS

5 POS

7 POS

9 POS

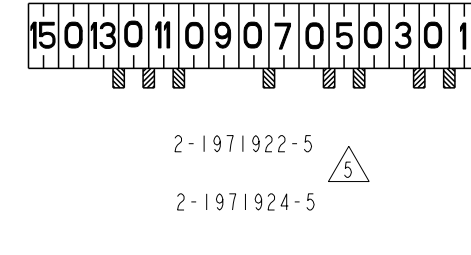
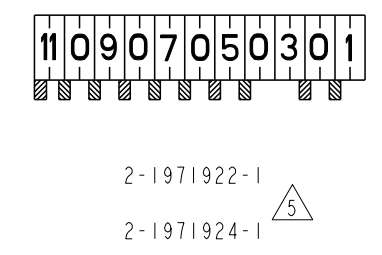
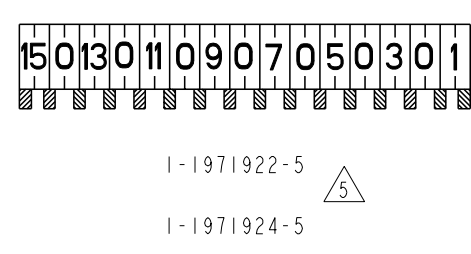
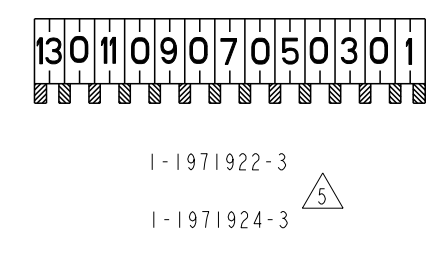
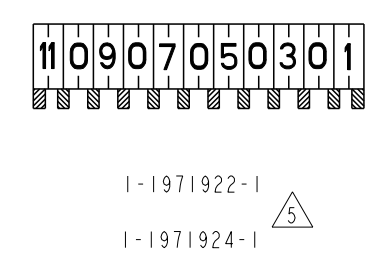

11 POS

13 POS

15 POS

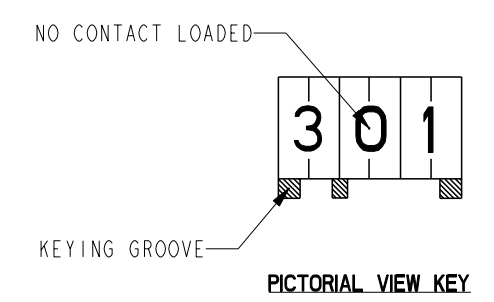

THIS DRAWING IS A CONTROLLED DOCUMENT.		OWN: BOB YANG	12NOV2012	STE TE Connectivity
DIMENSIONS: mm		CHK: HAPYE WU	12NOV2012	
TOLERANCES UNLESS OTHERWISE SPECIFIED:		APVD: YUHONG MAO	12NOV2012	NAME: RAST 2.5 TAB HEADER ASSY SELECTIVE LOADED, TH, VERTICAL, EXTERNAL LOCKING
0 PLC ±		PRODUCT SPEC		
1 PLC ±		APPLICATION SPEC		SIZE: A1 CAGE CODE: 00779 DRAWING NO: C=1971921
2 PLC ±		RESTRICTED TO		
3 PLC ±		SCALE: NTS	SHEET 3 OF 5	REV: A9
4 PLC ±		CUSTOMER DRAWING		
ANGLES ±°				
FINISH:				

LOC	DIST	REVISIONS					
		P	LYR	DESCRIPTION	DATE	OWN	APVD
-	-	-	-	SEE SHEET 1	-	-	-

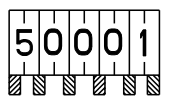

1-2825332-5

5 POS

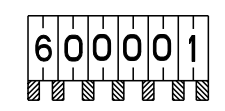

1-2825332-6

6 POS

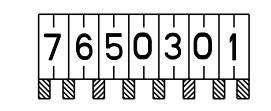

1-2825332-7

7 POS

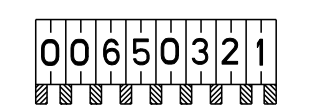

1-2825332-8

8 POS

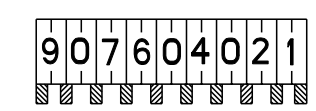

1-2825332-9

9 POS

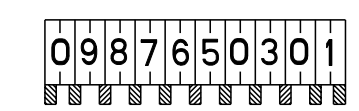

1-2825332-0

10 POS

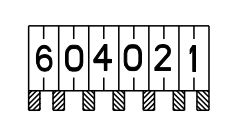

2-2825332-6

6 POS

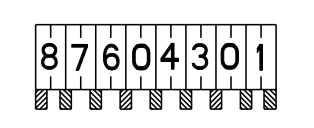

2-2825332-8

8 POS

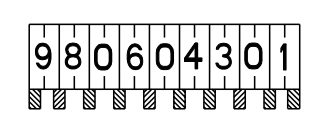

2-2825332-9

9 POS

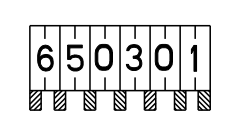

3-2825332-6

6 POS

PRELIMINARY PART - NOT RELEASED FOR PRODUCTION
 PART NUMBERS X-2825332-X ARE EQUIVALENT TO #-1971921-# IN GEOMETRY AND MATERIAL,
 WITH ADDITIONAL POSITIONS, CONTACT LOADING AND POLARIZATIONS, AS SHOWN.

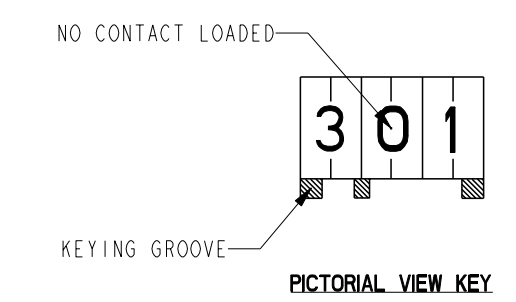

THIS DRAWING IS A CONTROLLED DOCUMENT.		OWN BOB YANG 12NOV2012	STE TE Connectivity	
DIMENSIONS: mm		CHK HAPYE WU 12NOV2012		
TOLERANCES UNLESS OTHERWISE SPECIFIED:		APVD YUHONG MAO 12NOV2012	NAME RAST 2.5 TAB HEADER ASSY SELECTIVE LOADED, TH, VERTICAL, EXTERNAL LOCKING	
0 PLC ±	1 PLC ±	PRODUCT SPEC	SIZE CAGE CODE DRAWING NO	
2 PLC ±0.20	3 PLC ±	APPLICATION SPEC	A1 00779 C=1971921	
4 PLC ±	5 PLC ±	WEIGHT	RESTRICTED TO	
ANGLES ±°	FINISH	CUSTOMER DRAWING	SCALE	SHEET 4 OF 5 REV A9

THIS DRAWING IS UNPUBLISHED. RELEASED FOR PUBLICATION 20
 © COPYRIGHT 20 BY - ALL RIGHTS RESERVED.

LOC		DIST		REVISIONS			
P	LTR	DESCRIPTION	DATE	DWN	APVD		
-	-	SEE SHEET 1	-	-	-		

FOR ANY KEYING CONFIGURATION, THERE ARE EIGHT COLORS AVAILABLE, BESIDES THE NATURAL COLOR, THERE ARE OTHER SEVEN COLORS, INCLUDE: YELLOW, BLUE, GREY, PURPLE, RED, GREEN, BLACK. THE WHITE VERSION IS PRELIMINARY. THE P/N OF THE COLOR CONNECTOR ARE BASED ON THE NATURAL CONNECTOR, THE PREFIX AND POSTFIX ARE THE SAME FOR THE SAME KEYING CONFIGURATION, BUT THE BASE NUMBERS ARE DIFFERENT ACCORDING TO DIFFERENT COLOR. THE FOLLOWING SHOWS WHAT'S THE P/N FOR COLOR CONNECTOR

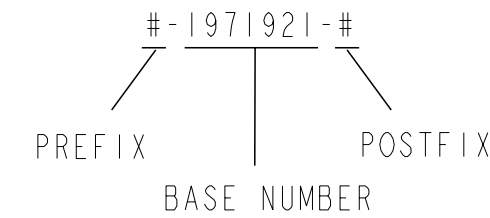

COLOR	PART NUMBER OF THE CONNECTOR ⁵				COMMENTS
	WITH TIN PLATING CONTACT		WITH AG PLATING CONTACT		
NATURAL	#-1971921-#	#-1971922-#	#-1971923-#	#-1971924-#	THE DETAIL P/N FOR DIFFERENT KEYING SEE SHEET 2 & 3
RED	#-2232189-#	#-2232190-#	#-2232191-#	#-2232192-#	THE PREFIX AND POSTFIX ARE THE SAME WITH THE P/N OF THE NATURAL CONNECTOR FOR THE SAME KEYING CONFIGURATION, JUST THE BASE NUMBERS ARE DIFFERENT BASED ON DIFFERENT COLOR. # CAN BE THE NUMBER FROM 0 TO 9.
BLUE	#-1971984-#	#-1971985-#	#-2232193-#	#-2232194-#	
YELLOW	#-2232195-#	#-2232196-#	#-2232197-#	#-2232198-#	
BALCK	#-2232199-#	#-2232200-#	#-2232201-#	#-2232202-#	
GREY	#-2232203-#	#-2232204-#	#-2232205-#	#-2232206-#	
GREEN	#-2232207-#	#-2232208-#	#-2232209-#	#-2232210-#	
PURPLE	#-2232211-#	#-2232212-#	#-2232213-#	#-2232214-#	
WHITE	#-2232285-#	#-2232286-#	#-2232287-#	#-2232288-#	

FOR EXAMPLE, IF A CONNECTOR WITH THE CONFIGURATION AS BELOW, AND WITH TIN PLATING CONTACT, IN THE SHEET 4, WE CAN FIND THE RELATED CONNECTOR P/N WITH NATURAL COLOR IS 3-1971921-3, THEN WE CAN LOOK IN THE ABOVE TABLE TO FIND THE CONNECTOR P/N WITH RED COLOR IS 3-2232189-3

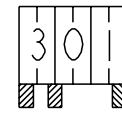

THIS DRAWING IS A CONTROLLED DOCUMENT.		DWN: 12NOV2012 WINTER WANG	TE Connectivity	
DIMENSIONS: mm		CHK: 12NOV2012 HAPYE WU		
TOLERANCES UNLESS OTHERWISE SPECIFIED:		APVD: 12NOV2012 YUHONG MAO	NAME: RAST 2.5 TAB HEADER ASSY SELECTIVE LOADED, TH, VERTICAL, EXTERNAL LOCKING	
0 PLC ± 1 PLC ± 2 PLC ±0.2 3 PLC ± 4 PLC ± ANGLES ±° FINISH		PRODUCT SPEC: -	SIZE: A2	CAGE CODE: 00779
MATERIAL: -		APPLICATION SPEC: -	DRAWING NO: C-1971921	RESTRICTED TO: -
		WEIGHT: -	SCALE: 5:1 SHEET 5 OF 5 REV A9	
		Customer Drawing		

X-ON Electronics

Largest Supplier of Electrical and Electronic Components

Click to view similar products for [Headers & Wire Housings](#) category:

Click to view products by [TE Connectivity](#) manufacturer:

Other Similar products are found below :

[892-18-020-10-001101](#) [58102-G61-06LF](#) [582553-1](#) [0009485154](#) [009176003701906](#) [0050291907](#) [LY20-4P-DT1-P1E-BR](#) [02.125.8002.8](#)
[609-3404](#) [61062-3](#) [61082-181009](#) [622-3653LF](#) [63453-116](#) [636-1030](#) [636-1427](#) [636-3427](#) [636-4007](#) [641938-9](#) [641991-4](#) [644827-2](#) [65817-](#)
[010LF](#) [65817-015LF](#) [65863-015LF](#) [66207-023LF](#) [67095-007LF](#) [67601157](#) [68645-018](#) [68648-049](#) [70.362.1628.0](#) [70-4210](#) [70-4226B](#) [70-](#)
[4853B](#) [707-5020](#) [707-5028](#) [71.350.2428.0](#) [71918-208LF](#) [71961-016LF](#) [733-134](#) [733-162](#) [754199-000](#) [760-3052](#) [787-8014-00](#) [79531-3000](#)
[FCN-360C032-B](#) [FCN-367T-T012/H](#) [FCN-723D010/2](#) [80.063.4001.1](#) [800-90-001-10-001000](#) [800-90-010-10-002000](#) [801-43-002-10-013000](#)