

THIS DRAWING IS UNPUBLISHED. RELEASED FOR PUBLICATION 20
 © COPYRIGHT 20 BY - ALL RIGHTS RESERVED.

LOC		DIST		REVISIONS			
P	LTR	DESCRIPTION		DATE	DWN	APVD	
A6		ECR-15-016520		25NOV2015	SL	RR	
A7		ECR-17-001536		03FEB2017	IZ	RR	
A8		ECR-18-008584		05JUN2018	BW	LZ	
A9		ECR-18-009485		19MAY2019	BW	WW	

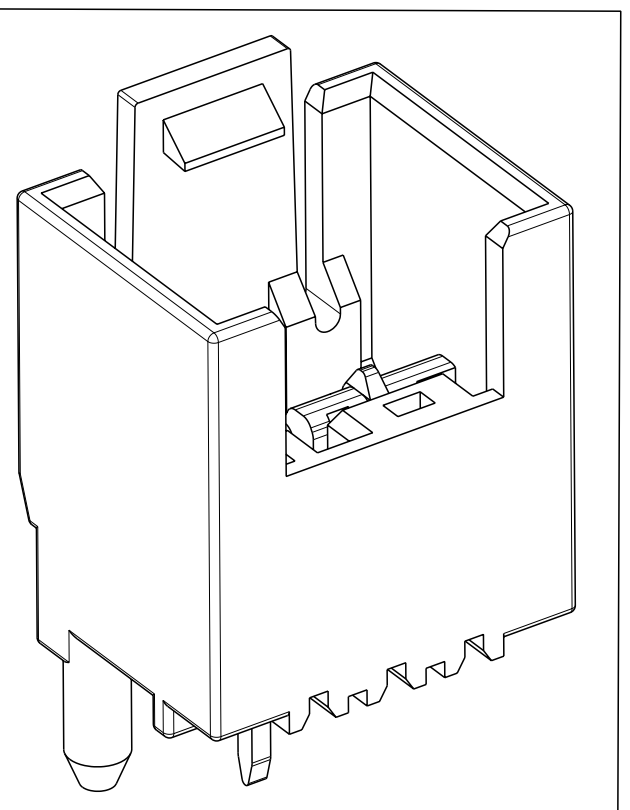
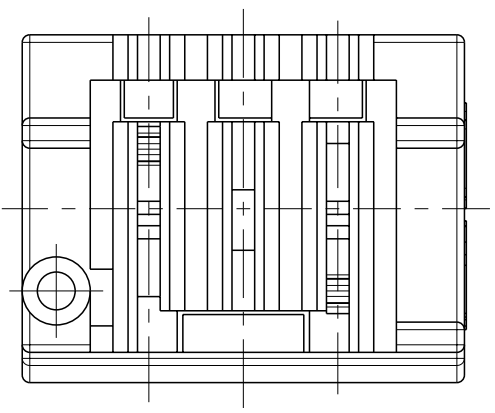
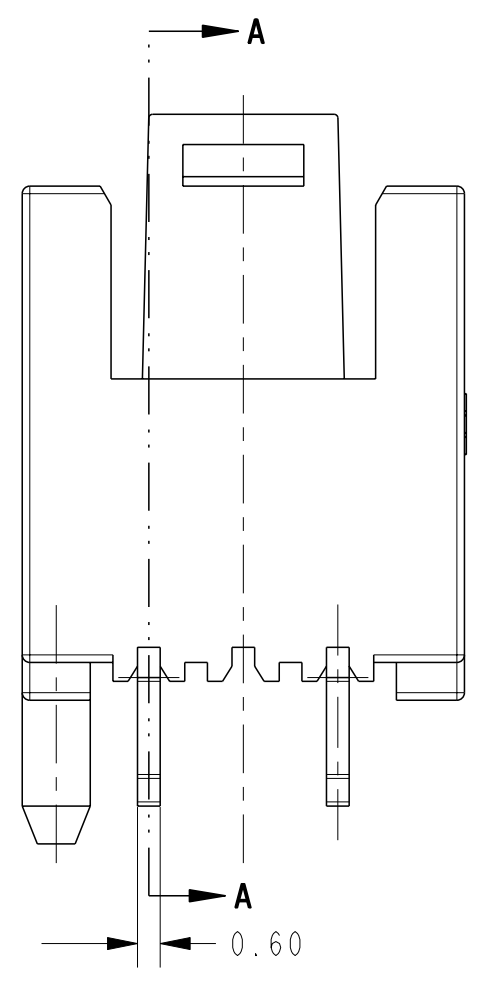
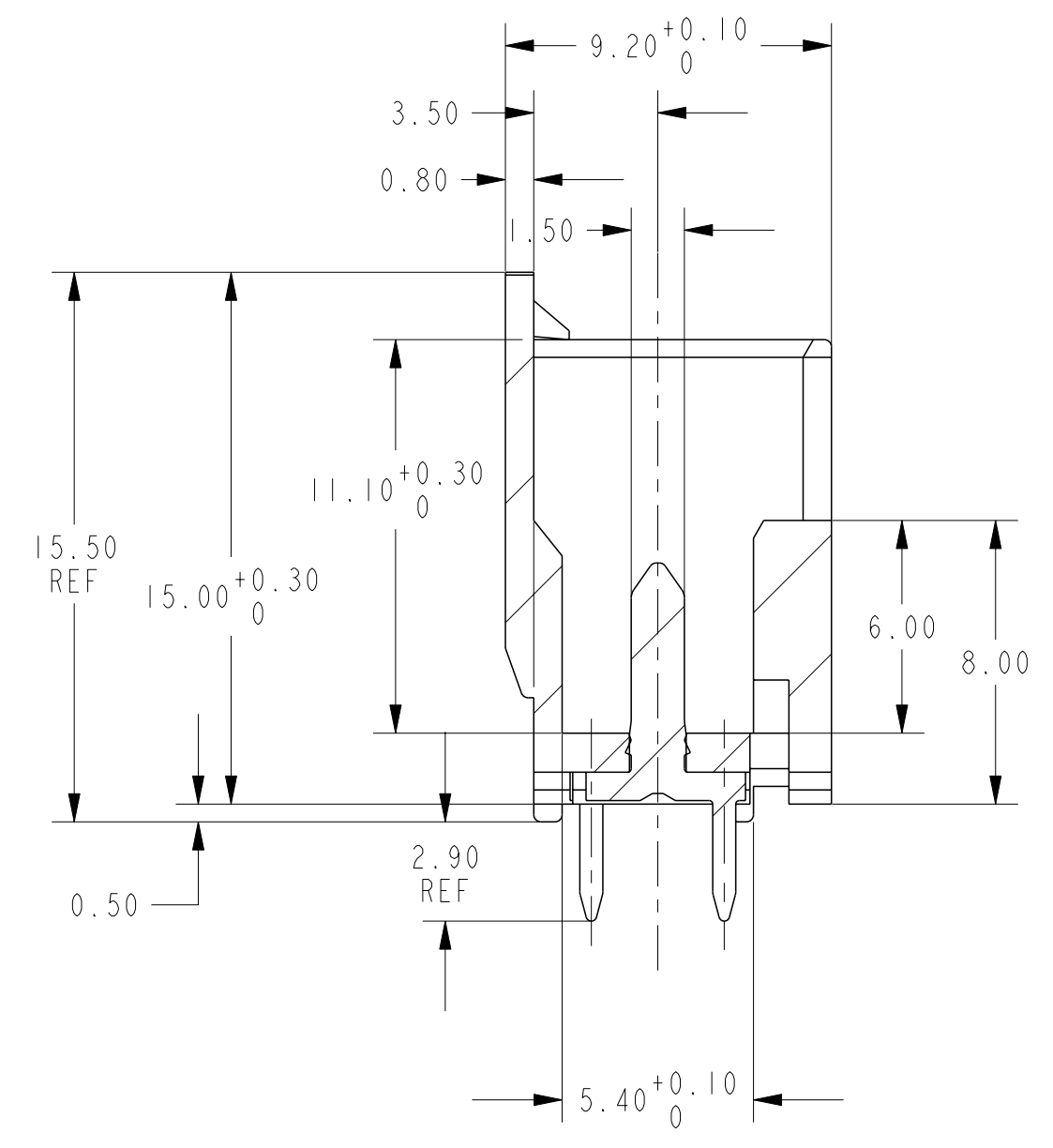
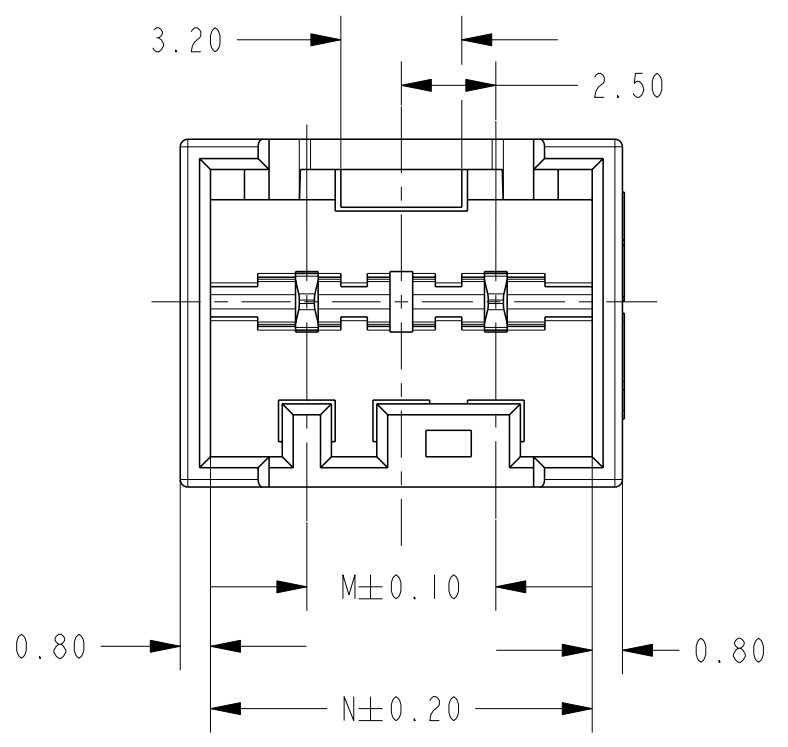

NOTE

- SEE SHEET 2 FOR AVAILABLE CONFIGURATIONS
- MATERIAL: HOUSING, NYLON, UL94 V0, 750°C GWT NO FLAME
EIGHT COLORS AVAILABLE, INCLUDING: NATURAL, RED, BLUE, YELLOW, BLACK, GREY, GREEN, PURPLE
WHITE VERSION IS PRELIMINARY

CONTACT, COPPER ALLOY, 0.60MM THICK
- FINISH: OPTION 1: TIN PLATING OVER NICKEL UNDERPLATING
OPTION 2: AG PLATING OVER NICKEL UNDERPLATING
- PCB LAYOUT AS SHOWN
- △ THE PART NUMBERS SHOWING IN SHEET 2 & 3 ARE FOR NATURAL COLOR. THE PART NUMBER FOR OTHER COLOR ARE BASED ON THE NATURAL ONE: FOR THE SAME CONFIGURATION, THE PREFIX AND POSTFIX OF THE P/N ARE THE SAME, ONLY THE BASE NUMBER IS DIFFERENT ACCORDING TO DIFFERENT COLOR, DETAIL PLEASE SEE SHEET 4
- PACKAGING: LOOSE PIECE OR TUBE. THE PART NUMBERS IN THIS DRAWING ARE WITH LOOSE PIECE PACKAGING. PLEASE CONTACT TE SALES REPRESENTATIVES FOR TUBE PACKAGING REQUIREMENT.
- △ PRELIMINARY PART NOT RELEASED FOR PRODUCTION

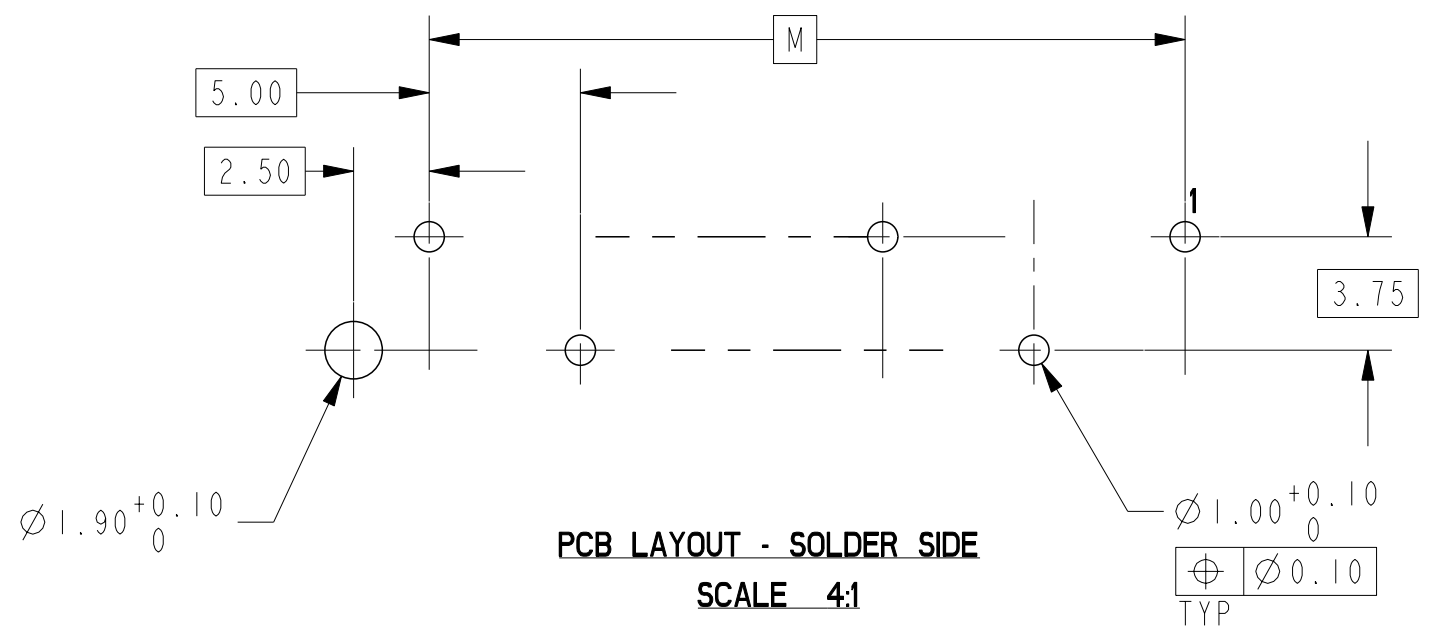

N	M	NO. OF POS.
40.10	35.00	8 LOAD, 15 POS.
35.10	30.00	7 LOAD, 13 POS.
30.10	25.00	6 LOAD, 11 POS.
25.10	20.00	5 LOAD, 9 POS.
20.10	15.00	4 LOAD, 7 POS.
15.10	10.00	3 LOAD, 5 POS.
10.10	5.00	2 LOAD, 3 POS.

THIS DRAWING IS A CONTROLLED DOCUMENT.

DWN	WINTER WANG	12NOV2012
CHK	HAPYE WU	12NOV2012
APVD	YUHQNG MAO	12NOV2012
PRODUCT SPEC	108-106079	
APPLICATION SPEC	-	
WEIGHT	-	
CUSTOMER DRAWING	-	

TE Connectivity

NAME: RAST 2.5 TAB HEADER ASSY, SELECTIVE LOADED, TH, VERTICAL, EXTERNAL LOCKING

SIZE	CAGE CODE	DRAWING NO	RESTRICTED TO
A2	00779	C-1971921	-

SCALE: NTS SHEET 1 OF 5 REV A9

THIS DRAWING IS UNPUBLISHED. RELEASED FOR PUBLICATION 20
 © COPYRIGHT 20 BY - ALL RIGHTS RESERVED.

LOC	DIST	REVISIONS					
ES	00	P	LTR	DESCRIPTION	DATE	DWN	APVD
		-		SEE SHEET 1	-	-	-

QTY	TAB CONTACT	QTY	HOUSING	POS.	TE PART NO.
8	TAB CONTACT w/ SILVER PLATING	1	RAST 2.5 TAB HEADER HOUSING, EXTERNAL LOCKING, 15P (SEE THE DETAIL LAYOUT ON SHEET 3)	15	3-1971924-5 2-1971924-5 1-1971924-5
7		1	RAST 2.5 TAB HEADER HOUSING, EXTERNAL LOCKING, 13P (SEE THE DETAIL LAYOUT ON SHEET 3)	13	1-1971924-3
6		1	RAST 2.5 TAB HEADER HOUSING, EXTERNAL LOCKING, 11P (SEE THE DETAIL LAYOUT ON SHEET 3)	11	2-1971924-1 1-1971924-1
5		1	RAST 2.5 TAB HEADER HOUSING, EXTERNAL LOCKING, 9P (SEE THE DETAIL LAYOUT ON SHEET 3)	9	6-1971923-9 5-1971923-9 4-1971923-9 3-1971923-9 2-1971923-9 1-1971923-9
4		1	RAST 2.5 TAB HEADER HOUSING, EXTERNAL LOCKING, 7P (SEE THE DETAIL LAYOUT ON SHEET 3)	7	8-1971923-7 7-1971923-7 6-1971923-7 5-1971923-7 4-1971923-7 3-1971923-7 2-1971923-7 1-1971923-7
3		1	RAST 2.5 TAB HEADER HOUSING, EXTERNAL LOCKING, 5P (SEE THE DETAIL LAYOUT ON SHEET 3)	5	6-1971923-5 5-1971923-5 4-1971923-5 3-1971923-5 2-1971923-5 1-1971923-5
2		1	RAST 2.5 TAB HEADER HOUSING, EXTERNAL LOCKING, 3P (SEE THE DETAIL LAYOUT ON SHEET 3)	3	1971923-3 9-1971923-3 8-1971923-3 7-1971923-3 6-1971923-3 5-1971923-3 4-1971923-3 3-1971923-3 2-1971923-3 1-1971923-3

QTY	TAB CONTACT	QTY	HOUSING	POS.	TE PART NO.
8	TAB CONTACT w/ TIN PLATING	1	RAST 2.5 TAB HEADER HOUSING, EXTERNAL LOCKING, 15P (SEE THE DETAIL LAYOUT ON SHEET 3)	15	3-1971922-5 2-1971922-5 1-1971922-5
7		1	RAST 2.5 TAB HEADER HOUSING, EXTERNAL LOCKING, 13P (SEE THE DETAIL LAYOUT ON SHEET 3)	13	1-1971922-3
6		1	RAST 2.5 TAB HEADER HOUSING, EXTERNAL LOCKING, 11P (SEE THE DETAIL LAYOUT ON SHEET 3)	11	2-1971922-1 1-1971922-1
5		1	RAST 2.5 TAB HEADER HOUSING, EXTERNAL LOCKING, 9P (SEE THE DETAIL LAYOUT ON SHEET 3)	9	6-1971921-9 5-1971921-9 4-1971921-9 3-1971921-9 2-1971921-9 1-1971921-9
4		1	RAST 2.5 TAB HEADER HOUSING, EXTERNAL LOCKING, 7P (SEE THE DETAIL LAYOUT ON SHEET 3)	7	8-1971921-7 7-1971921-7 6-1971921-7 5-1971921-7 4-1971921-7 3-1971921-7 2-1971921-7 1-1971921-7
3		1	RAST 2.5 TAB HEADER HOUSING, EXTERNAL LOCKING, 5P (SEE THE DETAIL LAYOUT ON SHEET 3)	5	9-1971921-5 8-1971921-5 7-1971921-5 6-1971921-5 5-1971921-5 4-1971921-5 3-1971921-5 2-1971921-5 1-1971921-5
2		1	RAST 2.5 TAB HEADER HOUSING, EXTERNAL LOCKING, 3P (SEE THE DETAIL LAYOUT ON SHEET 3)	3	1971921-3 9-1971921-3 8-1971921-3 7-1971921-3 6-1971921-3 5-1971921-3 4-1971921-3 3-1971921-3 2-1971921-3 1-1971921-3

THIS DRAWING IS A CONTROLLED DOCUMENT. 29MAY2012
 DWN BOB YANG 12NOV2012
 CHK HAPYE WU 12NOV2012
 APVD YUHHONG MAO 12NOV2012

STE TE Connectivity

NAME RAST 2.5 TAB HEADER ASSY,
SELECTIVE LOADED, TH, VERTICAL,
EXTERNAL LOCKING

DIMENSIONS: mm TOLERANCES UNLESS OTHERWISE SPECIFIED:
 0 PLC ±
 1 PLC ±
 2 PLC ±0.20
 3 PLC ±
 4 PLC ±
 ANGLES ±°
 FINISH

PRODUCT SPEC -
 APPLICATION SPEC -
 WEIGHT -

SIZE A2 CAGE CODE 00779 DRAWING NO C-1971921 RESTRICTED TO -
 CUSTOMER DRAWING SCALE NTS SHEET 2 OF 5 REV A9

LOC	DIST	REVISIONS					
		P	LYR	DESCRIPTION	DATE	OWN	APVD
		-	-	SEE SHEET 1	-	-	-



1-1971921-3 5-1971921-3
 1-1971923-3 5-1971923-3



2-1971921-3 6-1971921-3
 2-1971923-3 6-1971923-3

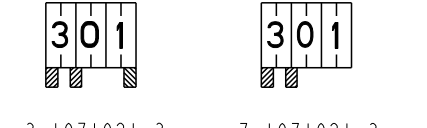

3-1971921-3 7-1971921-3
 3-1971923-3 7-1971923-3

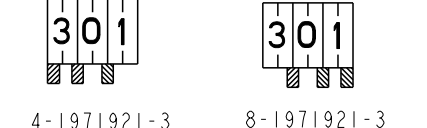

4-1971921-3 8-1971921-3
 4-1971923-3 8-1971923-3

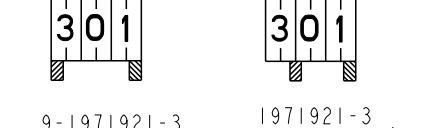

9-1971921-3 1971921-3
 9-1971921-3 1971921-3

3 POS



1-1971921-5 8-1971921-5
 1-1971923-5 8-1971923-5



2-1971921-5 9-1971921-5
 2-1971923-5 9-1971923-5

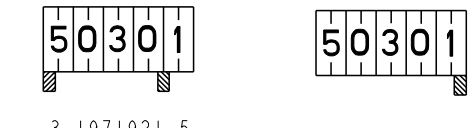

3-1971921-5 6-1971921-5
 3-1971923-5 6-1971923-5

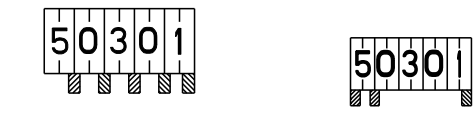

4-1971921-5 7-1971921-5
 4-1971923-5 7-1971921-5

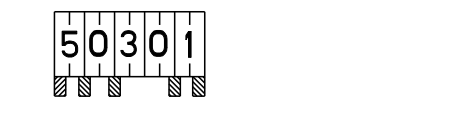

5-1971921-5 5-1971923-5

5 POS

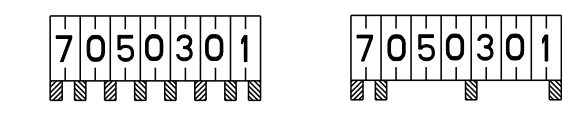

1-1971921-7 5-1971921-7
 1-1971923-7 5-1971923-7



2-1971921-7 6-1971921-7
 2-1971923-7 6-1971923-7

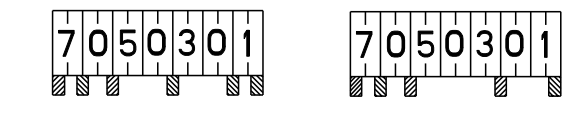

3-1971921-7 7-1971921-7
 3-1971923-7 7-1971923-7

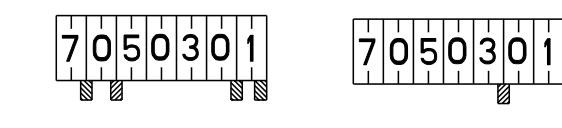

4-1971921-7 8-1971921-7
 4-1971923-7 8-1971923-7

7 POS

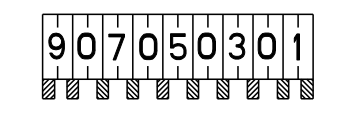

1-1971921-9 1-1971923-9

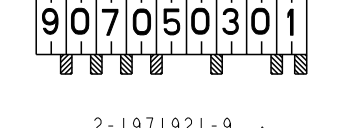

2-1971921-9 5-1971921-9
 2-1971923-9 5-1971923-9

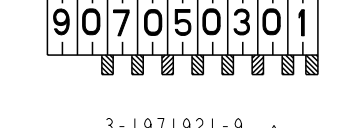

3-1971921-9 6-1971921-9
 3-1971923-9 6-1971923-9

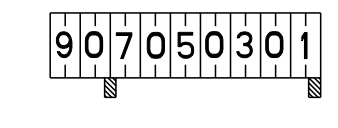

4-1971921-9 4-1971923-9

9 POS

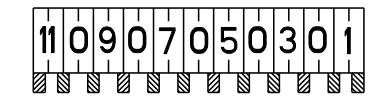

1-1971922-1 1-1971924-1

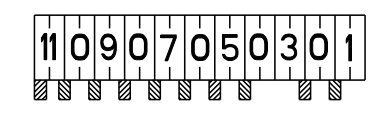

2-1971922-1 2-1971924-1

11 POS

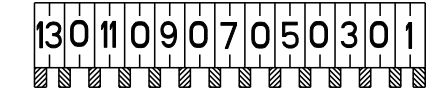

1-1971922-3 1-1971924-3

13 POS

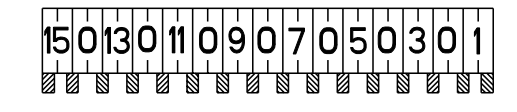

1-1971922-5 1-1971924-5

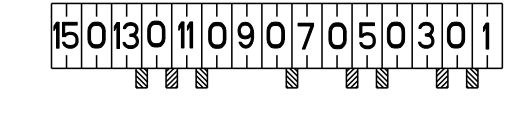

2-1971922-5 2-1971924-5

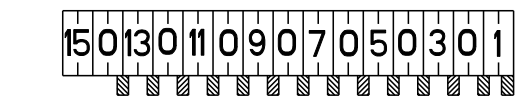

3-1971922-5 3-1971924-5

15 POS

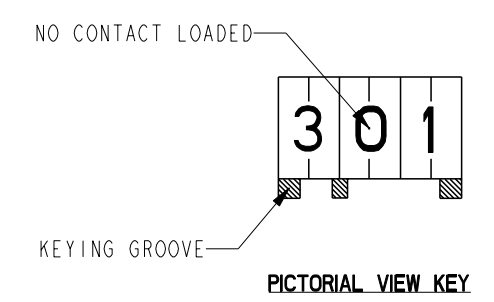

THIS DRAWING IS A CONTROLLED DOCUMENT.		OWN: BOB YANG	12NOV2012	STE TE Connectivity
DIMENSIONS: mm		CHK: HAPYE WU	12NOV2012	
TOLERANCES UNLESS OTHERWISE SPECIFIED:		APVD: YUHONG MAO	12NOV2012	NAME: RAST 2.5 TAB HEADER ASSY SELECTIVE LOADED, TH, VERTICAL, EXTERNAL LOCKING
0 PLC ±		PRODUCT SPEC		
1 PLC ±		APPLICATION SPEC		SIZE: A1 CAGE CODE: 00779 DRAWING NO: C=1971921
2 PLC ±		WEIGHT		
3 PLC ±		CUSTOMER DRAWING		SCALE: NTS SHEET 3 OF 5 REV A9
4 PLC ±				
ANGLES ±°				
FINISH				

LOC	DIST	REVISIONS					
		P	LYR	DESCRIPTION	DATE	OWN	APVD
-	-	-	-	SEE SHEET 1	-	-	-

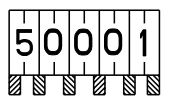

1-2825332-5

5 POS

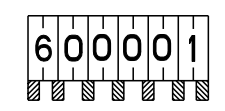

1-2825332-6

6 POS

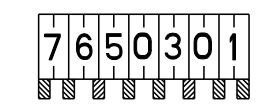

1-2825332-7

7 POS

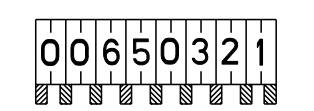

1-2825332-8

8 POS

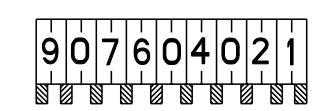

1-2825332-9

9 POS

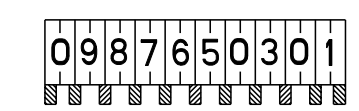

1-2825332-0

10 POS

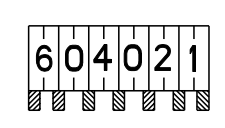

2-2825332-6

6 POS

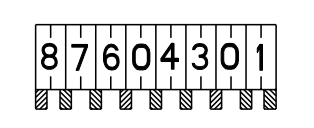

2-2825332-8

8 POS

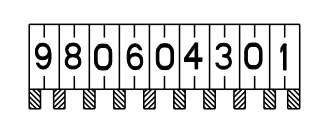

2-2825332-9

9 POS

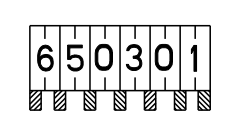

3-2825332-6

6 POS

PRELIMINARY PART - NOT RELEASED FOR PRODUCTION
 PART NUMBERS X-2825332-X ARE EQUIVALENT TO #-1971921-# IN GEOMETRY AND MATERIAL,
 WITH ADDITIONAL POSITIONS, CONTACT LOADING AND POLARIZATIONS, AS SHOWN.

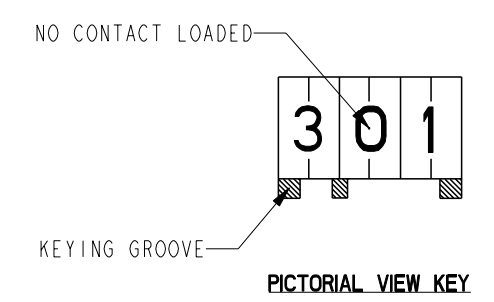

THIS DRAWING IS A CONTROLLED DOCUMENT.		OWN BOB YANG 12NOV2012	STE TE Connectivity	
DIMENSIONS: mm		CHK HAPYE WU 12NOV2012		
TOLERANCES UNLESS OTHERWISE SPECIFIED:		APVD YUHONG MAO 12NOV2012	NAME RAST 2.5 TAB HEADER ASSY SELECTIVE LOADED, TH, VERTICAL, EXTERNAL LOCKING	
0 PLC ±		PRODUCT SPEC	SIZE CAGE CODE DRAWING NO	
1 PLC ±		APPLICATION SPEC	RESTRICTED TO	
2 PLC ±0.20		WEIGHT	A1 00779 C=1971921	
3 PLC ±		CUSTOMER DRAWING	SCALE NTS SHEET 4 OF 5 REV A9	
4 PLC ±				
ANGLES ±°				
FINISH				

THIS DRAWING IS UNPUBLISHED. RELEASED FOR PUBLICATION 20
 © COPYRIGHT 20 BY - ALL RIGHTS RESERVED.

REVISIONS							
LOC	DIST	P	LTR	DESCRIPTION	DATE	DWN	APVD
-	-	-	-	SEE SHEET 1	-	-	-

FOR ANY KEYING CONFIGURATION, THERE ARE EIGHT COLORS AVAILABLE, BESIDES THE NATURAL COLOR, THERE ARE OTHER SEVEN COLORS, INCLUDE: YELLOW, BLUE, GREY, PURPLE, RED, GREEN, BLACK. THE WHITE VERSION IS PRELIMINARY. THE P/N OF THE COLOR CONNECTOR ARE BASED ON THE NATURAL CONNECTOR, THE PREFIX AND POSTFIX ARE THE SAME FOR THE SAME KEYING CONFIGURATION, BUT THE BASE NUMBERS ARE DIFFERENT ACCORDING TO DIFFERENT COLOR. THE FOLLOWING SHOWS WHAT'S THE P/N FOR COLOR CONNECTOR

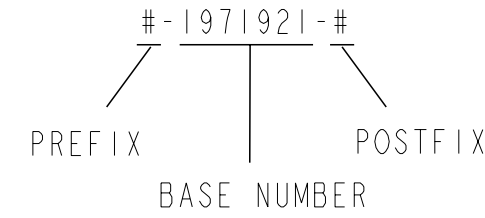

COLOR	PART NUMBER OF THE CONNECTOR				COMMENTS
	WITH TIN PLATING CONTACT		WITH AG PLATING CONTACT		
NATURAL	#-1971921-#	#-1971922-#	#-1971923-#	#-1971924-#	THE DETAIL P/N FOR DIFFERENT KEYING SEE SHEET 2 & 3
RED	#-2232189-#	#-2232190-#	#-2232191-#	#-2232192-#	THE PREFIX AND POSTFIX ARE THE SAME WITH THE P/N OF THE NATURAL CONNECTOR FOR THE SAME KEYING CONFIGURATION, JUST THE BASE NUMBERS ARE DIFFERENT BASED ON DIFFERENT COLOR. # CAN BE THE NUMBER FROM 0 TO 9.
BLUE	#-1971984-#	#-1971985-#	#-2232193-#	#-2232194-#	
YELLOW	#-2232195-#	#-2232196-#	#-2232197-#	#-2232198-#	
BALCK	#-2232199-#	#-2232200-#	#-2232201-#	#-2232202-#	
GREY	#-2232203-#	#-2232204-#	#-2232205-#	#-2232206-#	
GREEN	#-2232207-#	#-2232208-#	#-2232209-#	#-2232210-#	
PURPLE	#-2232211-#	#-2232212-#	#-2232213-#	#-2232214-#	
WHITE	#-2232285-#	#-2232286-#	#-2232287-#	#-2232288-#	

FOR EXAMPLE, IF A CONNECTOR WITH THE CONFIGURATION AS BELOW, AND WITH TIN PLATING CONTACT, IN THE SHEET 4, WE CAN FIND THE RELATED CONNECTOR P/N WITH NATURAL COLOR IS 3-1971921-3, THEN WE CAN LOOK IN THE ABOVE TABLE TO FIND THE CONNECTOR P/N WITH RED COLOR IS 3-2232189-3

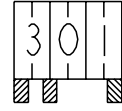

THIS DRAWING IS A CONTROLLED DOCUMENT.		DWN: 12NOV2012 WINTER WANG	TE Connectivity			
DIMENSIONS: mm		CHK: 12NOV2012 HAPYE WU				
		APVD: 12NOV2012 YUHONG MAO	NAME: RAST 2.5 TAB HEADER ASSY SELECTIVE LOADED, TH, VERTICAL, EXTERNAL LOCKING			
TOLERANCES UNLESS OTHERWISE SPECIFIED:		PRODUCT SPEC	SIZE: A2	CAGE CODE: 00779	DRAWING NO: C-1971921	RESTRICTED TO: -
MATERIAL: -		APPLICATION SPEC: -	SCALE: 5:1		SHEET: 5 OF 5	REV: A9
FINISH: -		WEIGHT: -	Customer Drawing			

X-ON Electronics

Largest Supplier of Electrical and Electronic Components

Click to view similar products for [Headers & Wire Housings](#) category:

Click to view products by [TE Connectivity](#) manufacturer:

Other Similar products are found below :

[892-18-020-10-001101](#) [58102-G61-06LF](#) [582553-1](#) [0009485154](#) [009176003701906](#) [0050291907](#) [LY20-4P-DT1-P1E-BR](#) [02.125.8002.8](#)
[609-3404](#) [61062-3](#) [61082-181009](#) [622-3653LF](#) [63453-116](#) [636-1030](#) [636-1427](#) [636-3427](#) [636-4007](#) [641938-9](#) [641991-4](#) [644827-2](#) [65817-](#)
[010LF](#) [65817-015LF](#) [65863-015LF](#) [66207-023LF](#) [67095-007LF](#) [67601157](#) [68645-018](#) [68648-049](#) [70.362.1628.0](#) [70-4210](#) [70-4226B](#) [70-](#)
[4853B](#) [707-5020](#) [707-5028](#) [71.350.2428.0](#) [71918-208LF](#) [71961-016LF](#) [733-134](#) [733-162](#) [754199-000](#) [760-3052](#) [787-8014-00](#) [79531-3000](#)
[FCN-360C032-B](#) [FCN-367T-T012/H](#) [FCN-723D010/2](#) [80.063.4001.1](#) [800-90-001-10-001000](#) [800-90-010-10-002000](#) [801-43-002-10-013000](#)