

REVISIONS				
P	LTR	DESCRIPTION	DATE	APVD
E2		REVISED PER ECO-15-014756	13OCT2015	DD JS

LEVER IN PRE-STAGE POSITION

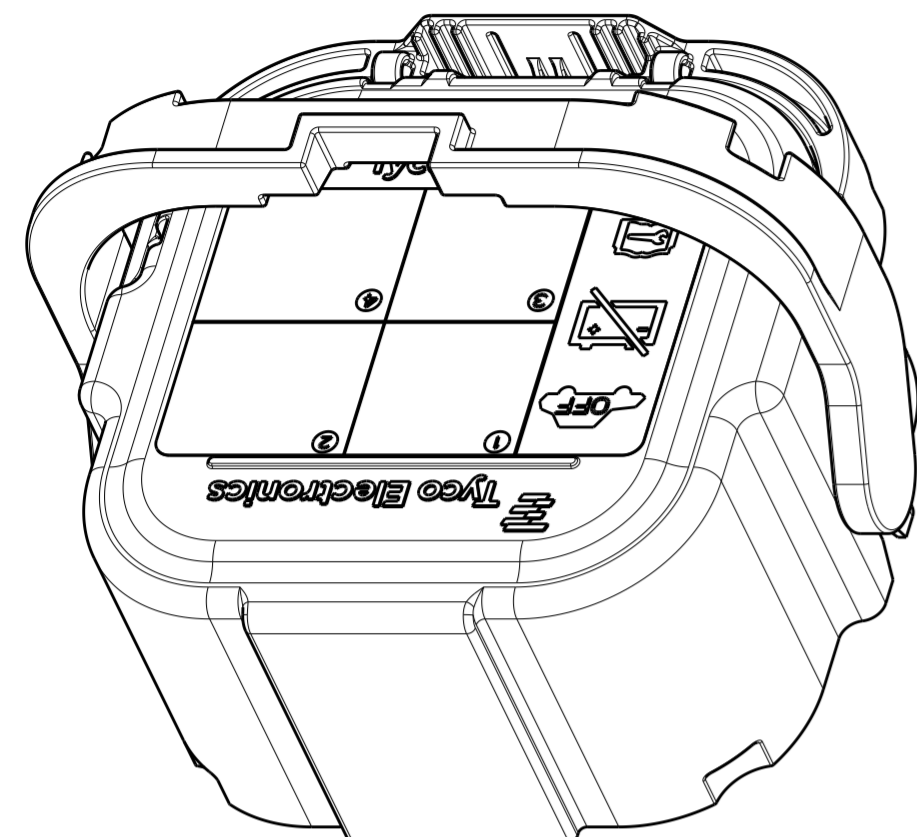

ISOMETRIC VIEW
SCALE 1:1

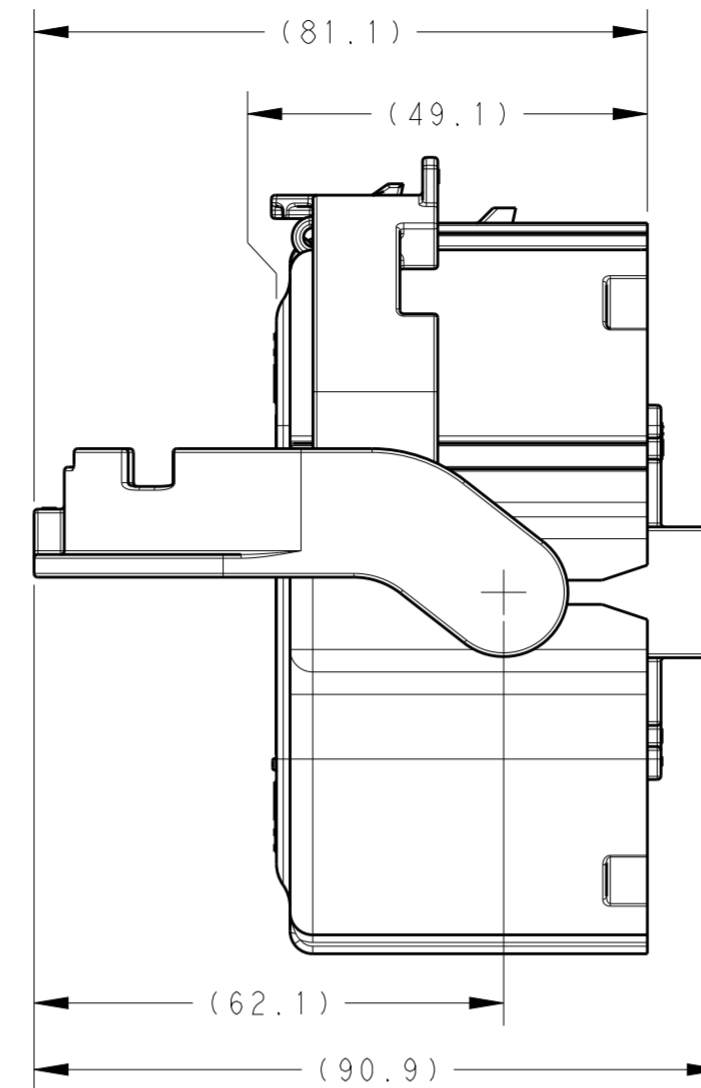
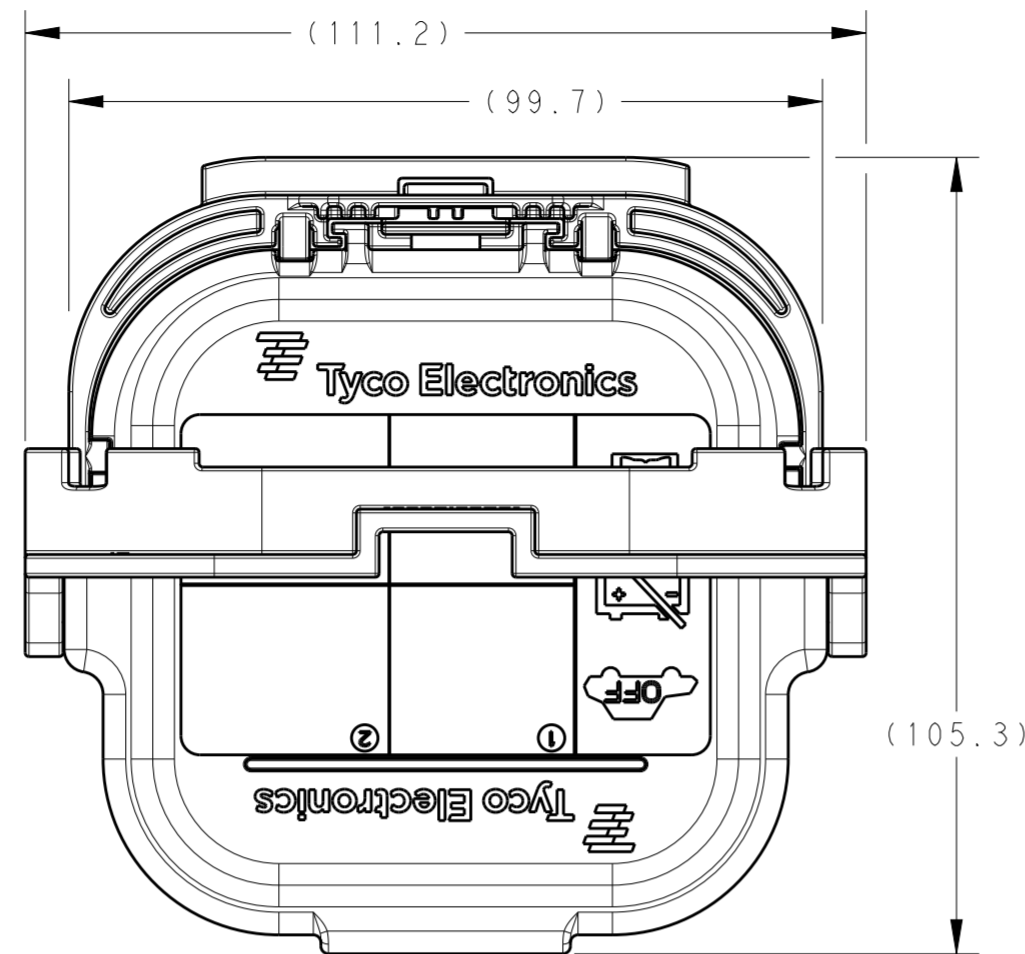

LEVER IN LOCKED POSITION

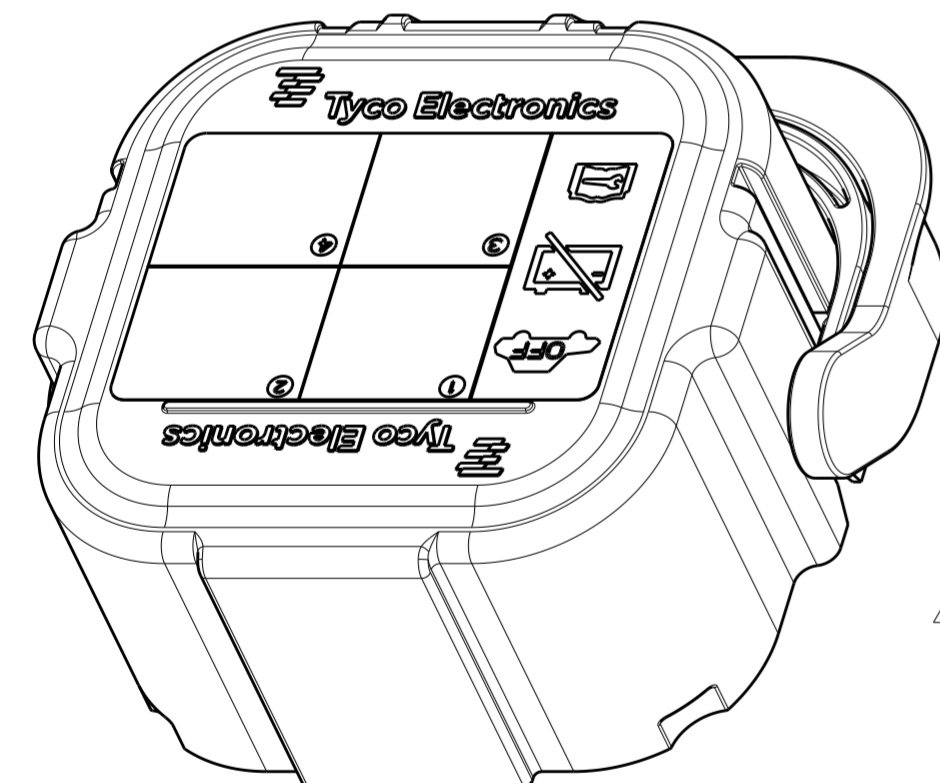

ISOMETRIC VIEW
SCALE 1:1

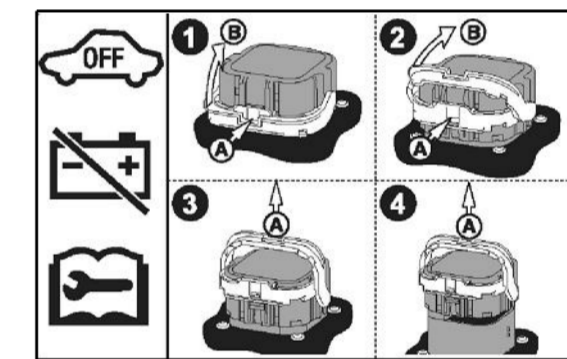
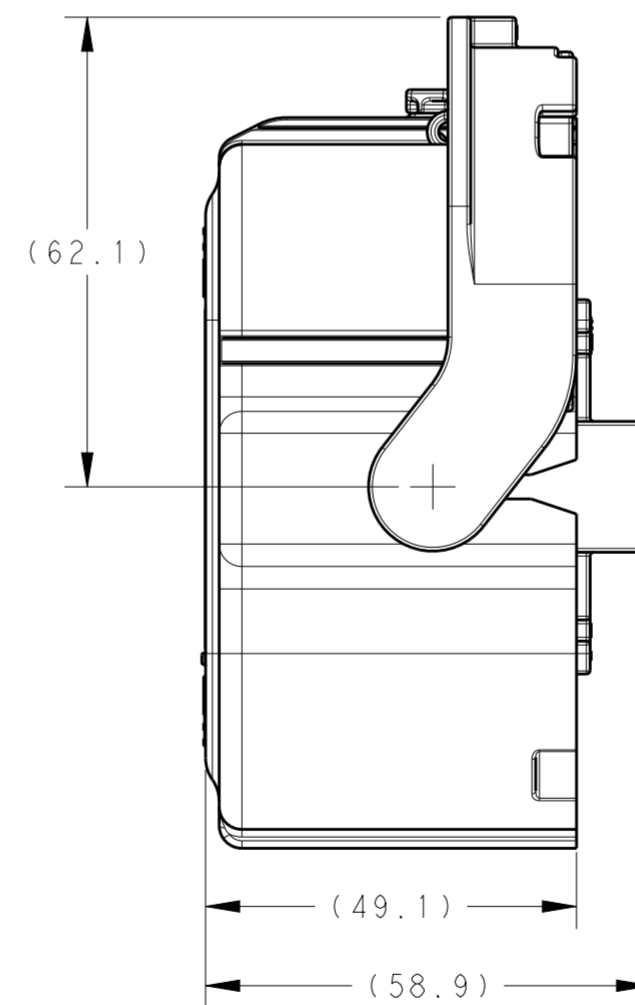
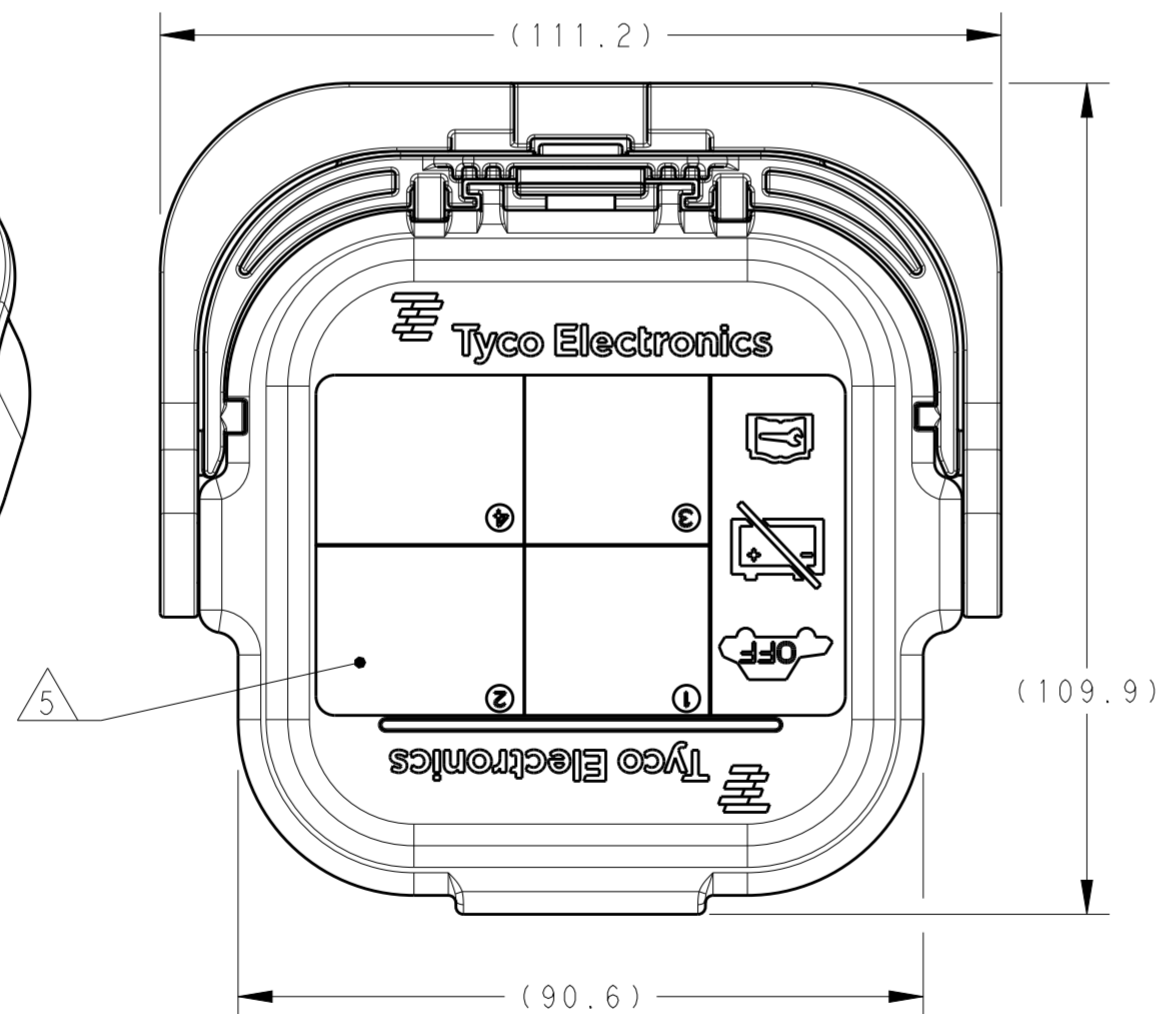

- ① INNER HOUSING MAY BE ASSEMBLED ROTATED 180° FROM AS SHOWN.
- ② ASSEMBLY / WORK INSTRUCTIONS: 408-10432
PRODUCT SPECIFICATION: 108-127000
APPLICATION SPECIFICATION: 501-127000
- ③ NOTE DELETED.
- ④ SEE TABLE AND SHEET 2 FOR FUSE RATINGS AND KEYING.
- ⑤ IMAGE FOR REFERENCE ONLY, SHOWS LABEL ORIENTATION.
- ⑥ ACTUAL APPEARANCE OF LABEL.

NATURAL/OFF-WHITE	261.25	SHUNT	2-2103212-7
NATURAL/OFF-WHITE	525.60	350A (EV)	2-2103212-2
BLACK	525.60	350A (EV)	2-2103212-1
NATURAL/OFF-WHITE	525.60	250A (EV)	1-2103212-9
NATURAL/OFF-WHITE	525.60	200A (EV)	1-2103212-8
BLACK	261.25	SHUNT	1-2103212-7
BLACK	525.60	350A	1-2103212-2
NATURAL/OFF-WHITE	525.60	350A	1-2103212-1
BLACK	525.60	250A	2103212-9
BLACK	525.60	200A	2103212-8
INNER LEVER COLOR	PART WEIGHT (g)	FUSE RATING	PART NO.

DIMENSIONS:		TOLERANCES UNLESS OTHERWISE SPECIFIED:	
mm			
0 PLC	±		
1 PLC	±		
2 PLC	±		
3 PLC	±		
4 PLC	±		
ANGLES	±		
FINISH			

DWN	A BOYER	14JUL2011
CHK	A BOYER	14JUL2011
APVD	A GUANCO	14JUL2011
PRODUCT SPEC		②
APPLICATION SPEC		②
WEIGHT	SEE TABLE	
CUSTOMER DRAWING		

STE TE Connectivity			
PLUG ASSEMBLY MANUAL SERVICE DISCONNECT			
SIZE	CAGE CODE	DRAWING NO	RESTRICTED TO
A200779	C-2103212		
SCALE	1:1	SHEET	1 OF 2
REV	E2		

REVISIONS				
P	LTR	DESCRIPTION	DATE	APVD
-	-	SEE SHEET 1	-	-

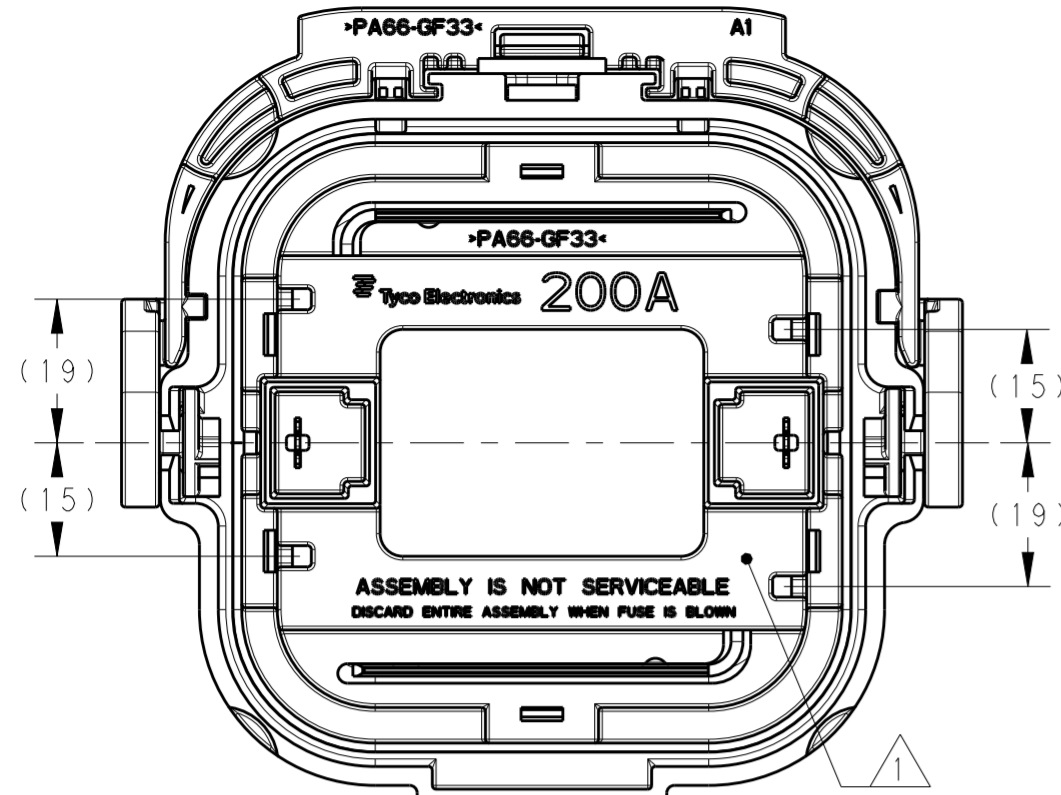

2103212-8 & 1-2103212-8
 FUSE RATING: 200A

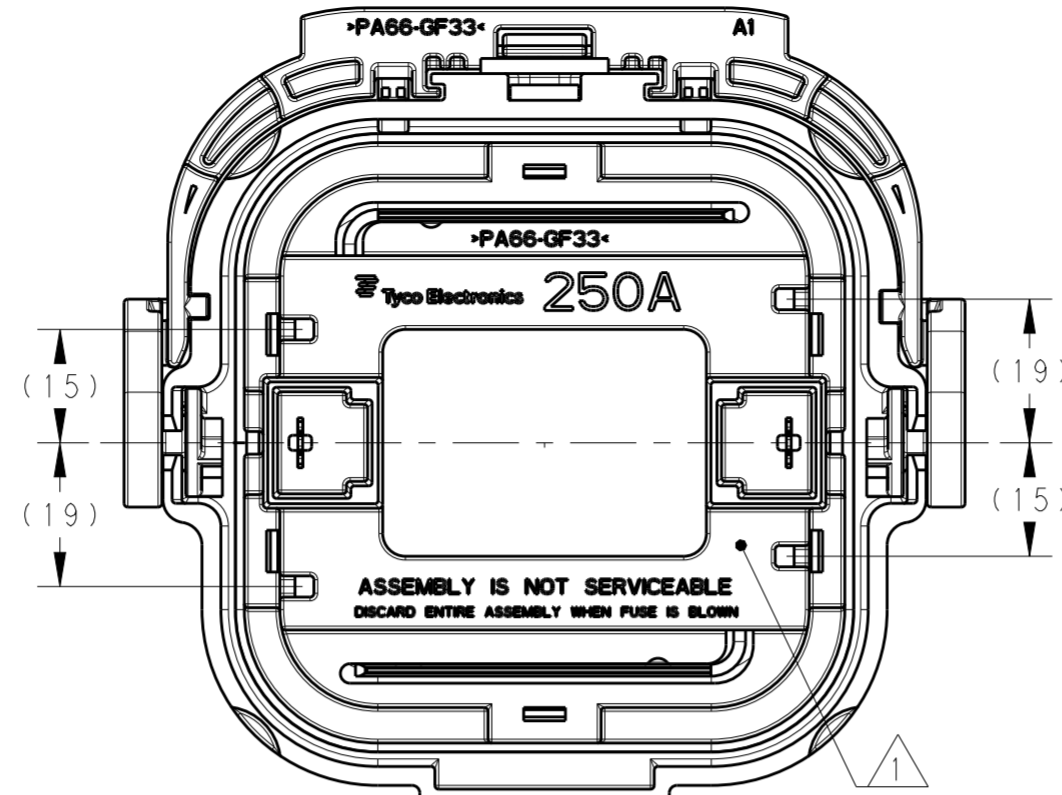

2103212-9 & 1-2103212-9
 FUSE RATING: 250A

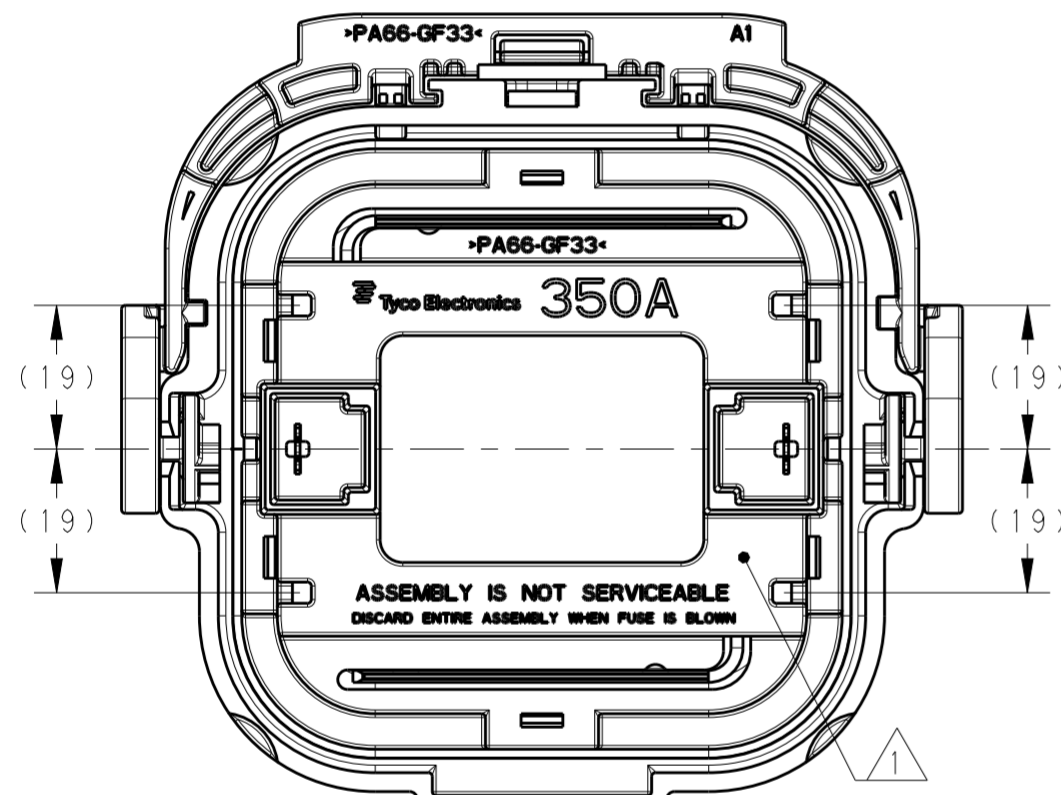

1-2103212-1, 1-2103212-2, 2-2103212-1
 & 2-2103212-2
 FUSE RATING: 350A

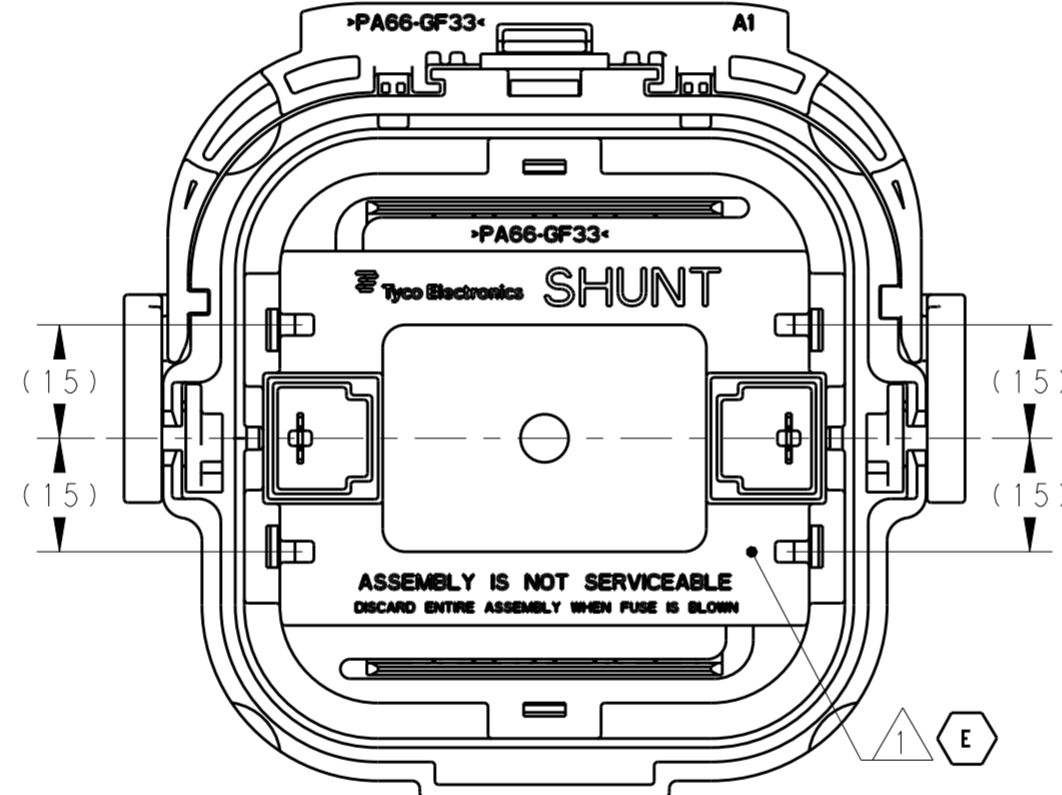

1-2103212-7 & 2-2103212-7
 SHUNT

THIS DRAWING IS A CONTROLLED DOCUMENT. DIMENSIONING AND TOLERANCING PER ASME Y14.5M-2009.		DWN A BOYER 14 JUL 2011	 TE Connectivity
DIMENSIONS: mm		CHK A BOYER 14 JUL 2011	
TOLERANCES UNLESS OTHERWISE SPECIFIED:		APVD A GUANCO 14 JUL 2011	
0 PLC ± 1 PLC ± 2 PLC ± 3 PLC ± 4 PLC ± ANGLES ± FINISH -		PRODUCT SPEC $\Delta 2$ APPLICATION SPEC $\Delta 2$ WEIGHT SEE TABLE CUSTOMER DRAWING	
		NAME PLUG ASSEMBLY MANUAL SERVICE DISCONNECT	RESTRICTED TO
		SIZE A200779	CAGE CODE C-2103212
		SCALE 1:1	SHEET 2 OF 2
		REV E2	

X-ON Electronics

Largest Supplier of Electrical and Electronic Components

Click to view similar products for [Automotive Connectors](#) category:

Click to view products by [TE Connectivity](#) manufacturer:

Other Similar products are found below :

[003-018-000](#) [60403001](#) [60993906-B](#) [M902-2131](#) [M902-2161](#) [72.330.1035.1](#) [73.353.4028.0](#) [F119300-B](#) [F166900](#) [F258300-B](#) [F358300-B](#)
[F407400](#) [F444110](#) [F487000](#) [F509500B-B](#) [827153-1](#) [8N1515-32-24P](#) [9-1326729-8](#) [925474-1](#) [928905-1](#) [964562-4](#) [968782-1](#) [GT17SA-8DS-](#)
[HU](#) [98891-1012](#) [98947-1016](#) [12004147](#) [12004475-L](#) [12010290](#) [12010309-B](#) [12015454](#) [12020219-B](#) [12020308](#) [12041318-B](#) [12052225-L](#)
[12052466](#) [12059125](#) [12064869](#) [12004327-B](#) [12010503-B](#) [12015308](#) [12015384](#) [12015909](#) [1-21030-1](#) [12041254](#) [12041318](#) [12047946-B](#)
[12047957](#) [12047957-L](#) [12059473](#) [12066261](#)