

THIS DRAWING IS UNPUBLISHED.

RELEASED FOR PUBLICATION

© COPYRIGHT

ALL RIGHTS RESERVED.

LOC DIST

REVISIONS

P	LTR	DESCRIPTION	DATE	DWN	APVD
A		INITIAL RELEASE	08AUG2014	PS	JK

REFERENCE MATING INTERFACE PATTERN:
1,27 STAGGERED PITCH x 1,5 ROW-DISTANCE.

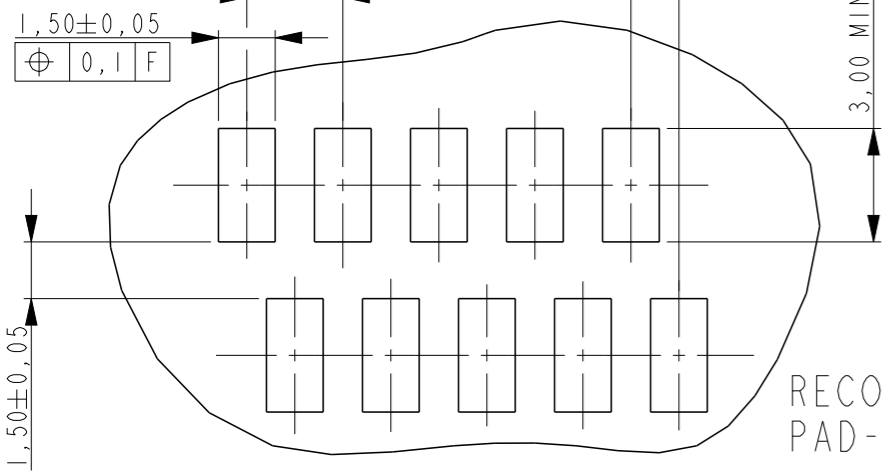
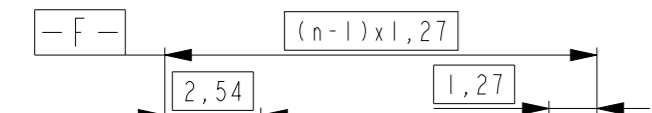
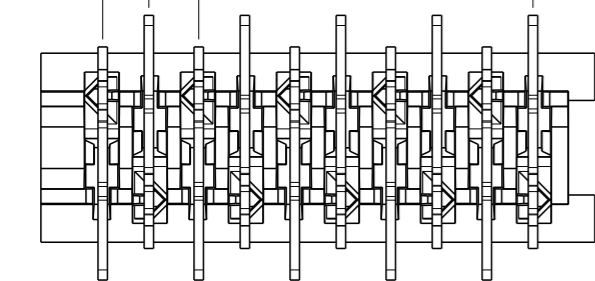
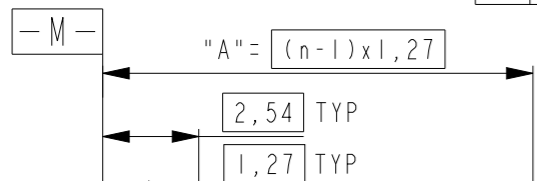
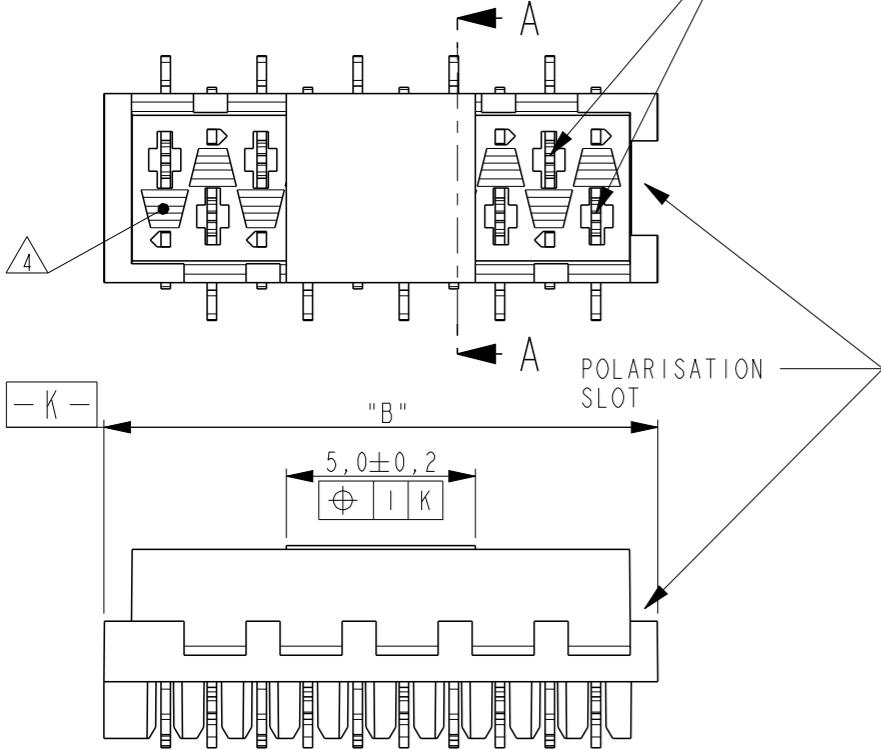

RECOMMENDED PC-BOARD
PAD-LAYOUT TOP VIEW

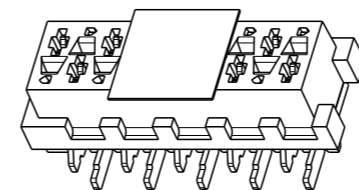
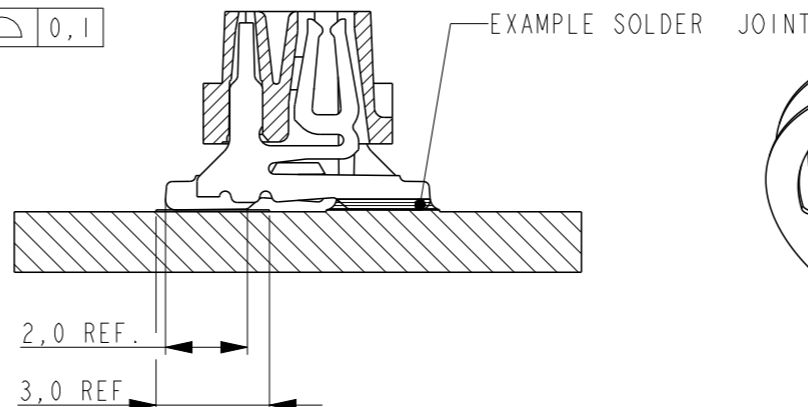
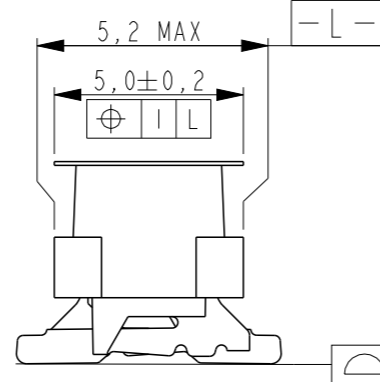
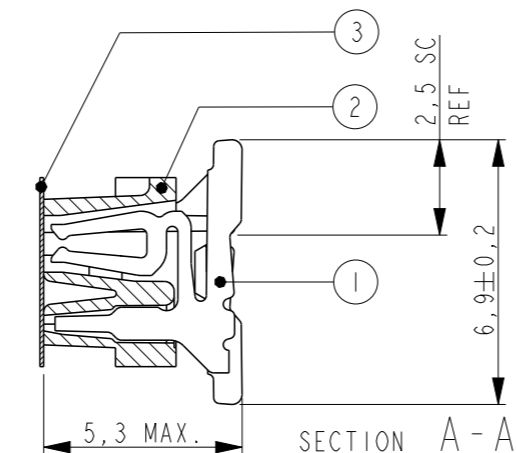

SCALE 3:1

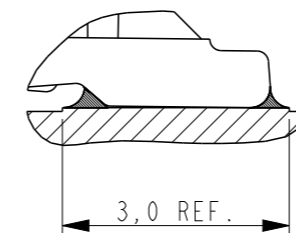

SOLDER DETAIL
SCALE 10:1

1	PARTNUMBER VAC. TAPE.	3	PARTNUMBER	NO. OF POS. "n"	"A"	"B" MAX.
	7-2178711-4		2178711-4	4	3,81	7,1
	7-2178711-6		2178711-6	6	6,35	9,7
	7-2178711-8		2178711-8	8	8,89	12,2
	8-2178711-0		1-2178711-0	10	11,43	14,7
	8-2178711-2		1-2178711-2	12	13,97	17,3
	8-2178711-4		1-2178711-4	14	16,51	19,8
	8-2178711-6		1-2178711-6	16	19,05	22,4
	8-2178711-8		1-2178711-8	18	21,59	24,9
	9-2178711-0		2-2178711-0	20	24,13	27,5

NOTES:

- 1 TAPE FOR VACUUM P&P ONLY FOR DASHNUMBERS 7- /8- /9-
- 2 FOR PACKAGING SEE SHEET 2 OF 2
- 3 WITHOUT VACUUM TAPE.
- 4 CORING-OUTS FOR MANUFACTURING PURPOSE ONLY.
SHAPE MAY VARY, BUT IS NOT FUNCTIONAL FOR THE APPLICATION.
- 5 SHOWN IS A 10 POSITION CONNECTOR.

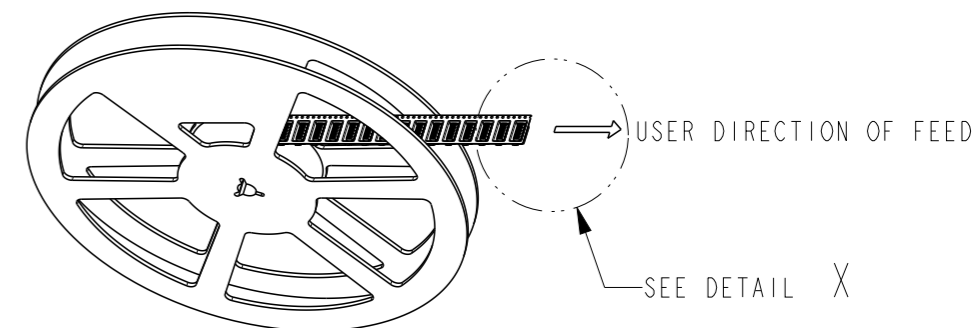

ACCORDING EIA-481/DIN IEC 286

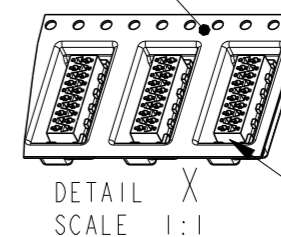

DETAIL X
SCALE 1:1
POLARIZATION-SLOT
ON THIS SIDE.

ITEM NO.	COMPONENT DESCRIPTION	MATERIAL	FINISH / COLOR
3	PICK & PLACE TAPE	KAPTON	AMBER TRANSPARENT
2	FEMALE HOUSING	POLYAMIDE 4/6,GF	BLACK
1	FEMALE CONTACT	TIN BRASS	3.0 - 5.0µm TIN OVER 0.5µm NICKEL

THIS DRAWING IS A CONTROLLED DOCUMENT.		DWN 30JUL2014 PRASHANTH	TE Connectivity	
DIMENSIONS: mm		CHK 05AUG2014 PRASHANTH		
TOLERANCES UNLESS OTHERWISE SPECIFIED:		APVD 05AUG2014 JAYANTH KUMAR	NAME Micro-MaTch VALUE LINE FEMALE-ON-BOARD, TOP ENTRY, SMD, CONNECTOR	
0 PLC ±-		PRODUCT SPEC 108-32087	SIZE A3	
1 PLC ±-		APPLICATION SPEC 114-13318	CAGE CODE 00779	DRAWING NO C-2178711
2 PLC ±-		WEIGHT -	RESTRICTED TO -	
3 PLC ±-		CUSTOMER DRAWING	SCALE 5:1	SHEET 1 OF 2
4 PLC ±-				REV A
ANGLES ±-				
FINISH SEE TABLE				

THIS DRAWING IS UNPUBLISHED.

RELEASED FOR PUBLICATION

© COPYRIGHT -

ALL RIGHTS RESERVED.

LOC	DIST	REVISIONS					
		P	LTR	DESCRIPTION	DATE	DWN	APVD
-	-			SEE SHEET 1			

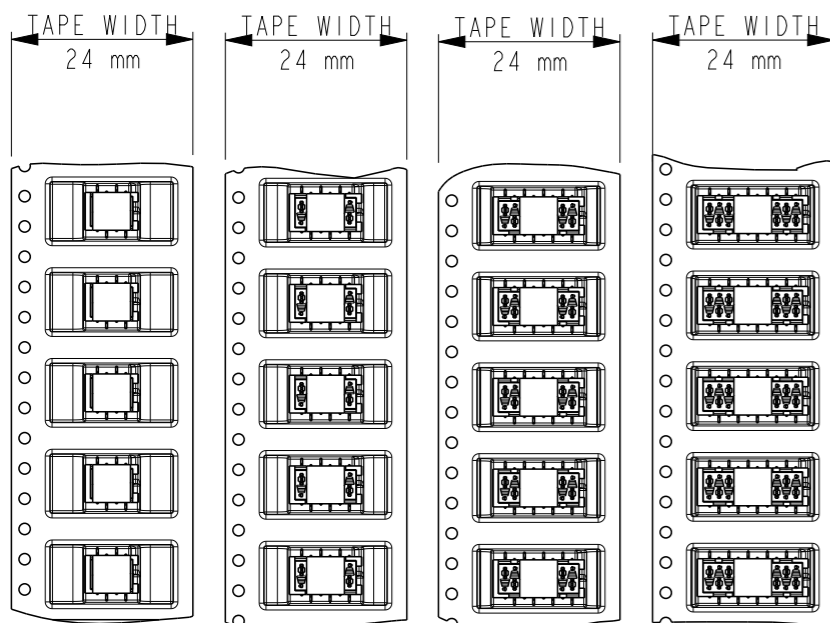

7-2178711-4	7-2178711-6	7-2178711-8	8-2178711-0
4 POSITION	6 POSITION	8 POSITION	10 POSITION
2178711-4	2178711-6	2178711-8	1-2178711-0

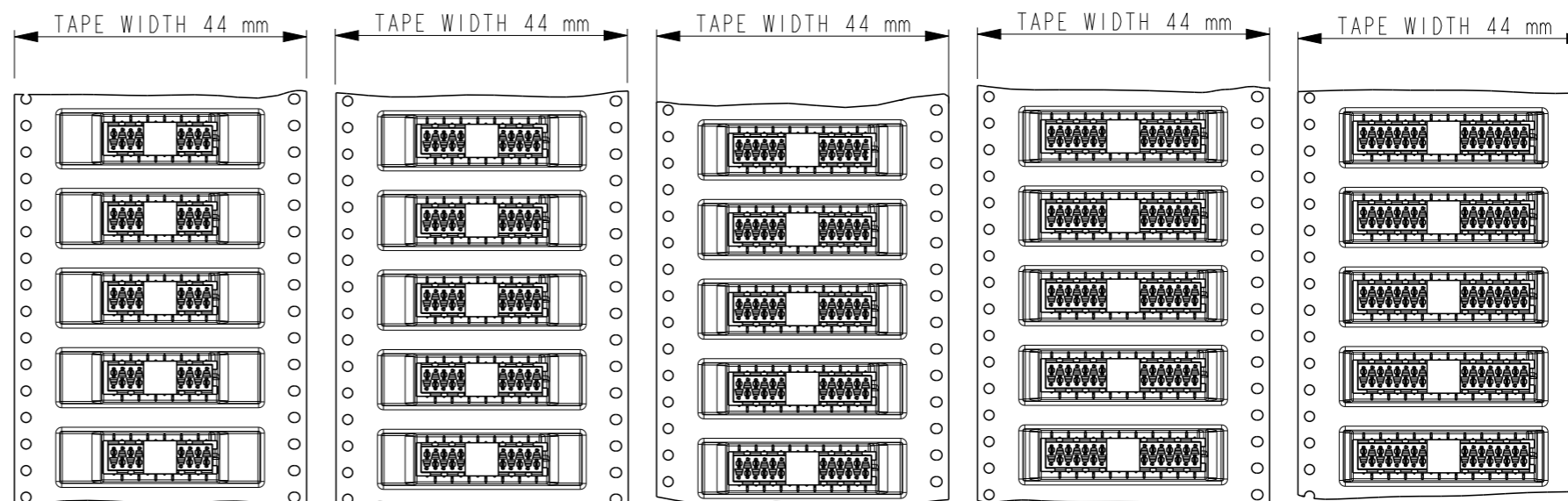
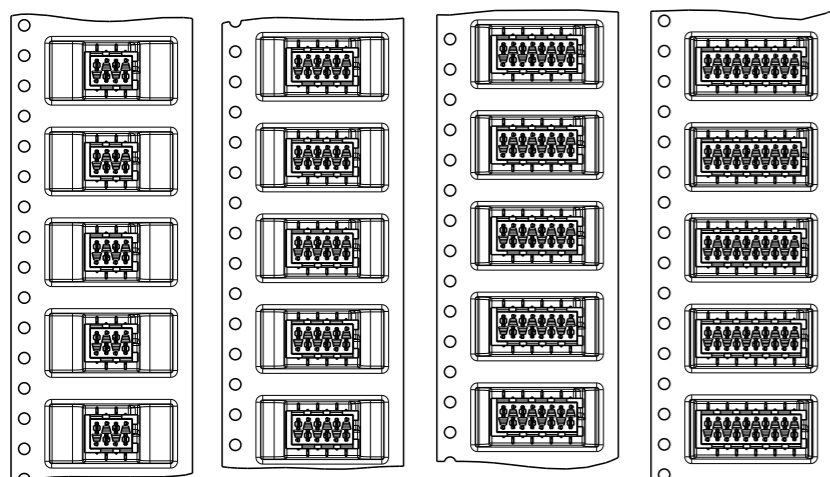

8-2178711-2	8-2178711-4	8-2178711-6	8-2178711-8	9-2178711-0
12 POSITION	14 POSITION	16 POSITION	18 POSITION	20 POSITION
1-2178711-2	1-2178711-4	1-2178711-6	1-2178711-8	2-2178711-0

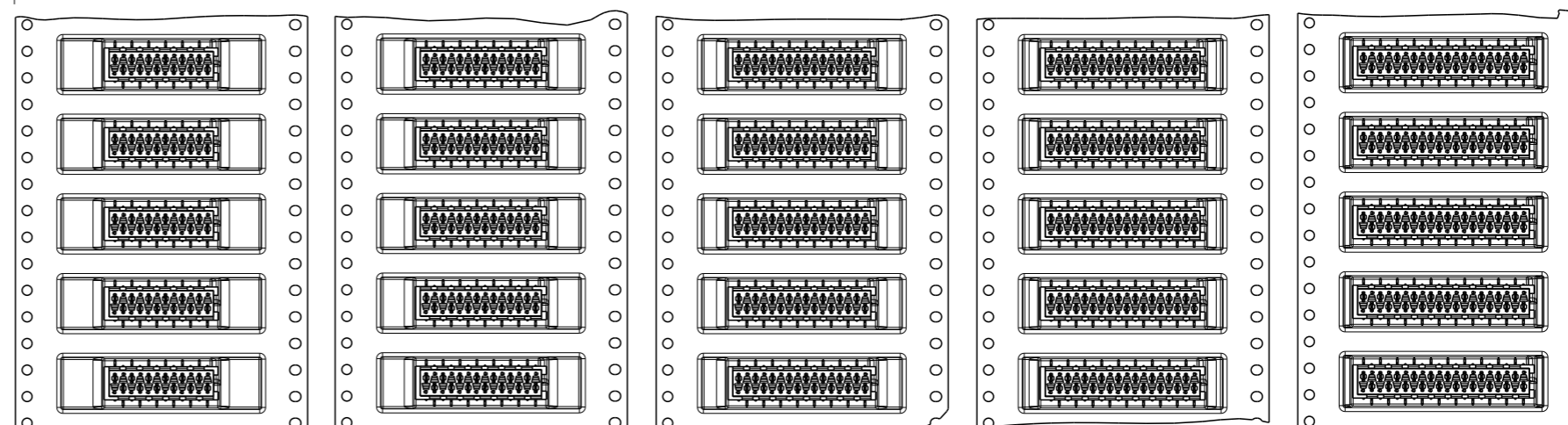

THIS DRAWING IS A CONTROLLED DOCUMENT.

DIMENSIONS:
mm

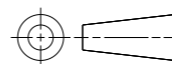

TOLERANCES UNLESS OTHERWISE SPECIFIED:

- 0 PLC ±-
- 1 PLC ±0.1
- 2 PLC ±0.05
- 3 PLC ±-
- 4 PLC ±-
- ANGLES ±-
- FINISH -

MATERIAL -

DWN 25JUL2014
PRASHANTH
CHK 05AUG2014
PRASHANTH
APVD 05AUG2014
JAYANTH KUMAR
PRODUCT SPEC
108-32087
APPLICATION SPEC
114-13318
WEIGHT -

CUSTOMER DRAWING



NAME
Micro-MaTch VALUE LINE
FEMALE-ON-BOARD, TOP ENTRY,
SMD, CONNECTOR

SIZE	CAGE CODE	DRAWING NO	RESTRICTED TO
A3	00779	©-2178711	-

SCALE 1:1 SHEET 2 OF 2 REV A

X-ON Electronics

Largest Supplier of Electrical and Electronic Components

Click to view similar products for [Headers & Wire Housings](#) category:

Click to view products by [TE Connectivity](#) manufacturer:

Other Similar products are found below :

[892-18-020-10-001101](#) [58102-G61-06LF](#) [582553-1](#) [0009485154](#) [009176003701906](#) [0050291907](#) [LY20-4P-DT1-P1E-BR](#) [02.125.8002.8](#)
[609-3404](#) [61062-3](#) [61082-181009](#) [622-3653LF](#) [63453-116](#) [636-1030](#) [636-1427](#) [636-3427](#) [636-4007](#) [641938-9](#) [641991-4](#) [644827-2](#) [65817-010LF](#) [65817-015LF](#) [65863-015LF](#) [66207-023LF](#) [67095-007LF](#) [67601157](#) [68645-018](#) [68648-049](#) [70.362.1628.0](#) [70-4210](#) [70-4226B](#) [70-4853B](#) [707-5020](#) [707-5028](#) [71.350.2428.0](#) [71918-208LF](#) [71961-016LF](#) [733-134](#) [733-162](#) [754199-000](#) [760-3052](#) [787-8014-00](#) [79531-3000](#)
[FCN-360C032-B](#) [FCN-367T-T012/H](#) [FCN-723D010/2](#) [80.063.4001.1](#) [800-90-001-10-001000](#) [800-90-010-10-002000](#) [801-43-002-10-013000](#)