

THIS DRAWING IS UNPUBLISHED. RELEASED FOR PUBLICATION 20  
 © COPYRIGHT 20 BY - ALL RIGHTS RESERVED.

REVISIONS					
P	LTR	DESCRIPTION	DATE	DWN	APVD
	A	INITIAL RELEASE	07MAR2018	RS	SZ
	A1	REVISE PER ECR-18-008492	06JUN2018	RS	SZ

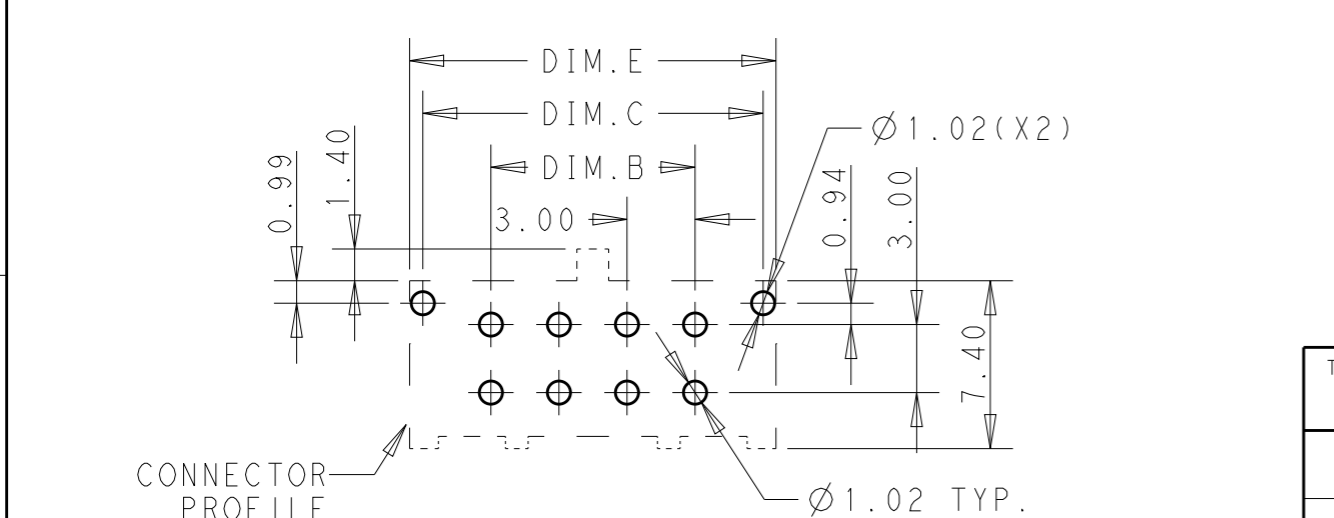
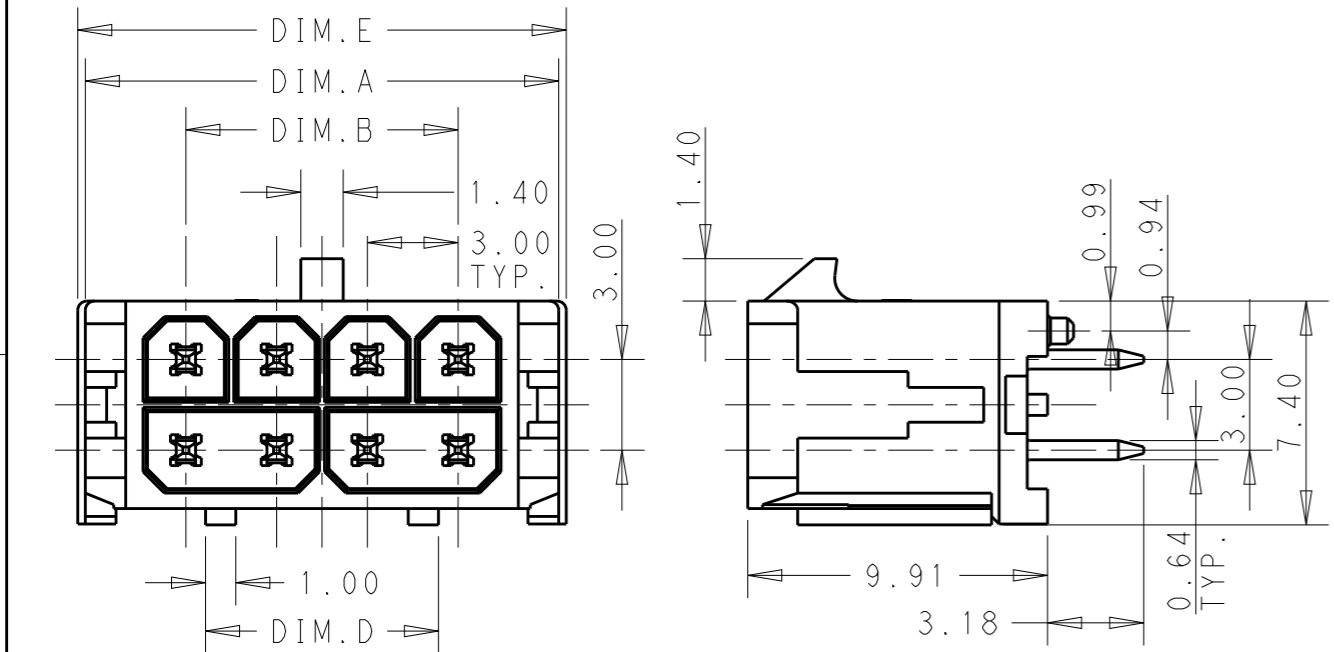
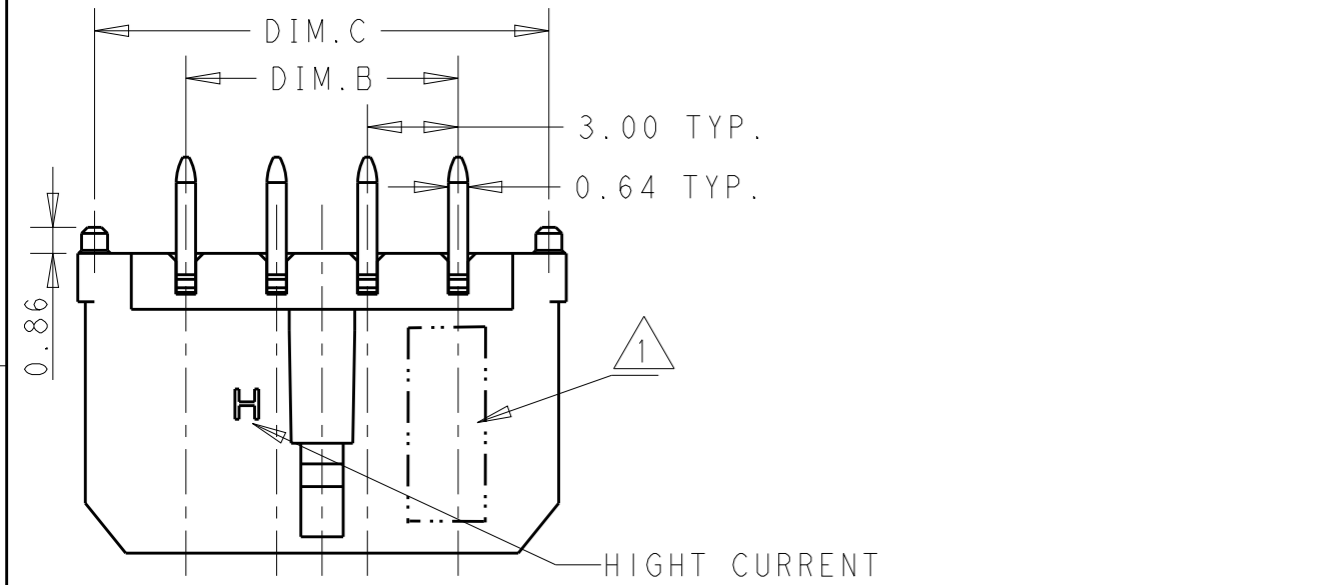

RECOMMENDED PCB LAYOUT (COMPONENT SIDE)  
 PCB THICKNESS=1.57MM  
 DEFAULT TOLERANCE: ±0.05

NOTES:  
 1. PART NUMBER AND DATE CODE.  
 2. MATERIAL:  
 HOUSING: THERMO PLASTIC, COLOR:BLACK.  
 TERMINAL: COPPER ALLOY.  
 3. PLATING: SEE REMARK IN PART NUMBER LIST.

	40.15	31.70	39.00	33.00	39.65	24	*-2204801-9
	37.15	28.70	36.00	30.00	36.65	22	*-2204801-0
	34.15	25.70	33.00	27.00	33.65	20	9-2204801-*
	31.15	22.70	30.00	24.00	30.65	18	8-2204801-*
	28.15	19.70	27.00	21.00	27.65	16	7-2204801-*
	25.15	16.70	24.00	18.00	24.65	14	6-2204801-*
	22.15	13.70	21.00	15.00	21.65	12	5-2204801-*
	19.15	10.70	18.00	12.00	18.65	10	4-2204801-*
	16.15	7.70	15.00	9.00	15.65	8	3-2204801-*
	13.15	2.95	12.00	6.00	12.65	6	2-2204801-*
	10.15	2.95	9.00	3.00	9.65	4	1-2204801-*
	7.15	2.95	6.00	N/A	6.65	2	2204801-*

\*: PLATING ON CONTACT AREA  
 1: GOLD FLASH  
 2: 5u" GOLD PLATING  
 3: 10u" GOLD PLATING  
 4: 15u" GOLD PLATING  
 5: 30u" GOLD PLATING  
 7: 100u" BRIGHT TIN PLATING  
 8: 100u" MATTE TIN PLATING

THIS DRAWING IS A CONTROLLED DOCUMENT.		DWN 06-JUN-17 Radar Sun	 TE Connectivity	
		CHK 06-JUN-17 Sunny Zhao		
DIMENSIONS: mm		APVD 06-JUN-17 Sunny Zhao	NAME ELCON MICRO POWER CONNECTOR, HEADER, VERTICAL DIP, 3.00MM PITCH, 2XN CIRCUITS	
TOLERANCES UNLESS OTHERWISE SPECIFIED: 0 PLC ±0.30 1 PLC ±0.30 2 PLC ±0.20 3 PLC ± 4 PLC ± ANGLES ±		PRODUCT SPEC 108-128068	SIZE A3	
MATERIAL		APPLICATION SPEC -	CAGE CODE 00779	
FINISH		WEIGHT -	DRAWING NO C-2204801	
		CUSTOMER DRAWING	RESTRICTED TO -	
		SCALE 4:1	SHEET 1 OF 2	
			REV A1	

THIS DRAWING IS UNPUBLISHED. RELEASED FOR PUBLICATION 20  
© COPYRIGHT 20 BY - ALL RIGHTS RESERVED.

REVISIONS

P	LTR	DESCRIPTION	DATE	DWN	APVD
-	-	SEE SHEET 1	-	-	-

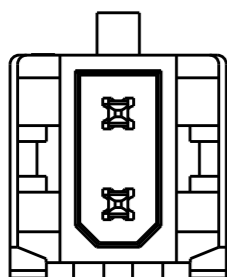

CIRCUIT SIZE:2

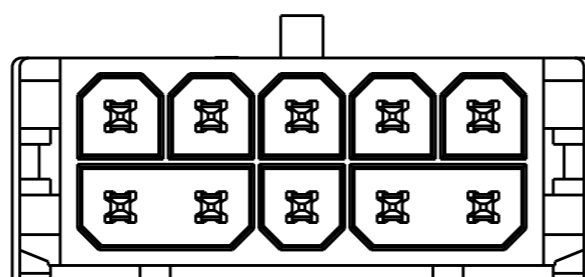

CIRCUIT SIZE:10

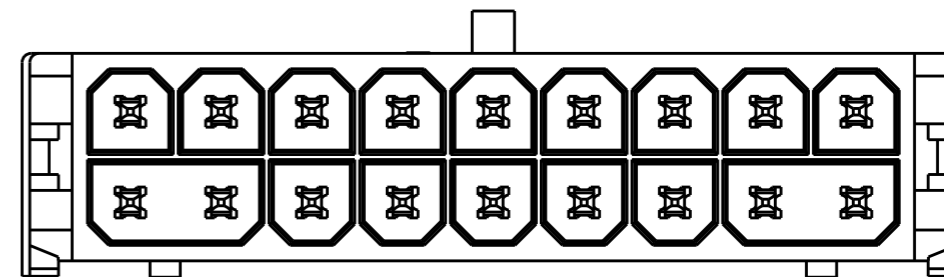

CIRCUIT SIZE:18

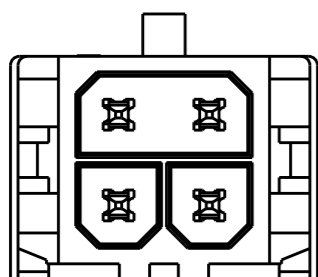

CIRCUIT SIZE:4

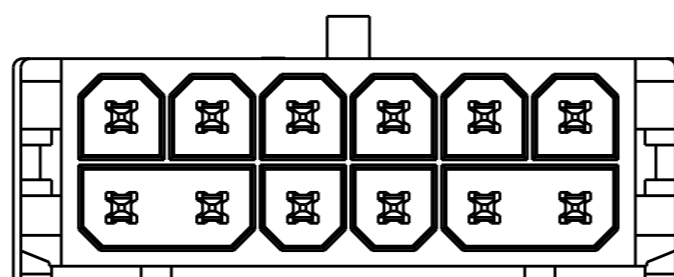

CIRCUIT SIZE:12

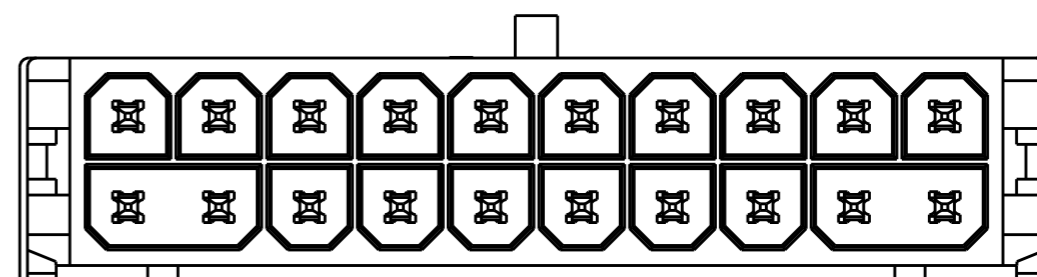

CIRCUIT SIZE:20

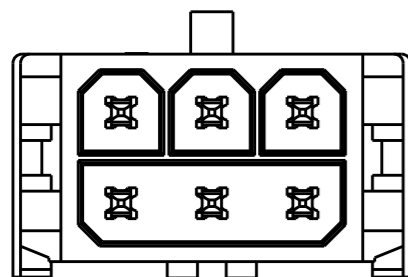

CIRCUIT SIZE:6

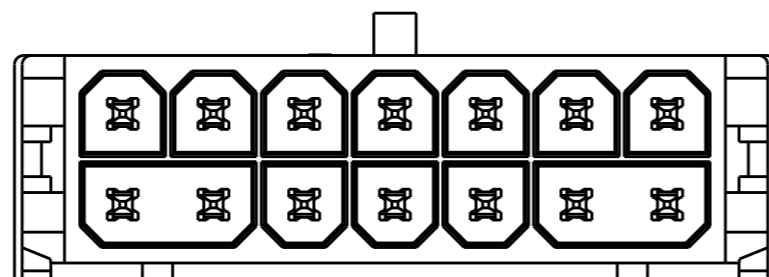

CIRCUIT SIZE:14

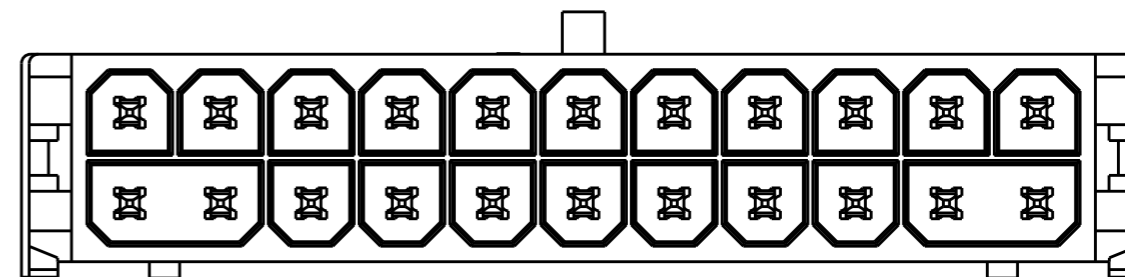

CIRCUIT SIZE:22

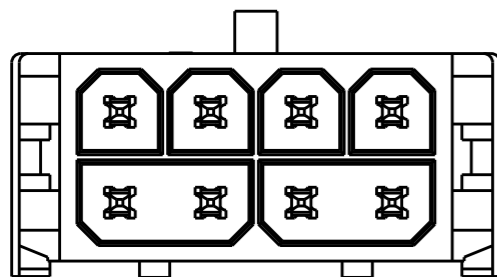

CIRCUIT SIZE:8

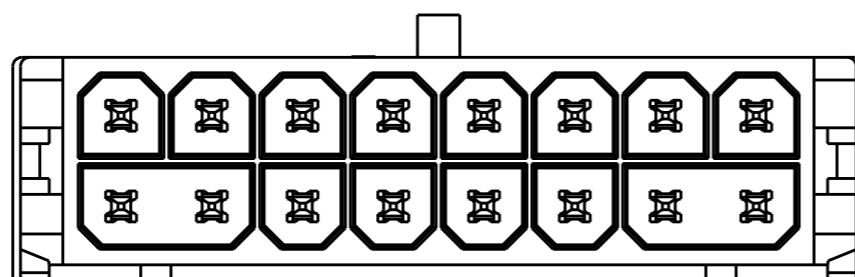

CIRCUIT SIZE:16

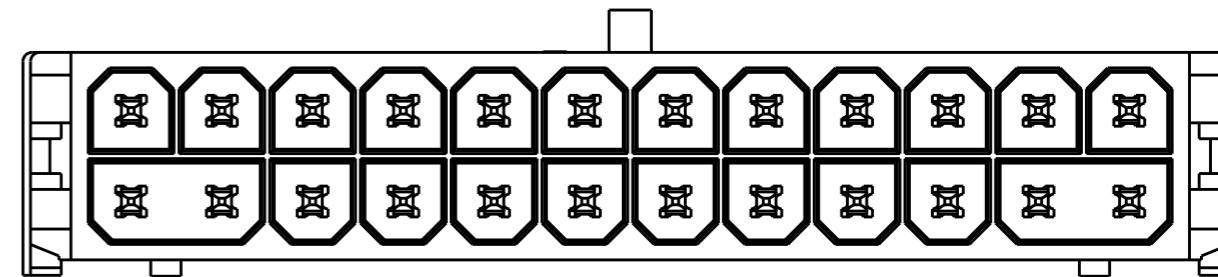

CIRCUIT SIZE:24

THIS DRAWING IS A CONTROLLED DOCUMENT.

DIMENSIONS:

mm

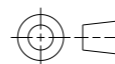

TOLERANCES UNLESS OTHERWISE SPECIFIED:

- 0 PLC ±-
- 1 PLC ±0.30
- 2 PLC ±0.20
- 3 PLC ±-
- 4 PLC ±-
- ANGLES ±-

MATERIAL

FINISH

DWN 06-JUN-17

Radar Sun

CHK 06-JUN-17

Suny Zhao

APVD 06-JUN-17

Suny Zhao

PRODUCT SPEC

108-128068

APPLICATION SPEC

-

WEIGHT

-

CUSTOMER DRAWING



TE Connectivity

NAME  
ELCON MICRO POWER CONNECTOR,  
HEADER, VERTICAL DIP,  
3.00MM PITCH, 2XN CIRCUITS

SIZE CAGE CODE DRAWING NO RESTRICTED TO

A3 00779 C-2204801

SCALE 4:1 SHEET 2 OF 2 REV A1

## X-ON Electronics

Largest Supplier of Electrical and Electronic Components

*Click to view similar products for [Power to the Board](#) category:*

*Click to view products by [TE Connectivity](#) manufacturer:*

Other Similar products are found below :

[6450171-4](#) [6450552-7](#) [6600323-8](#) [6643429-1](#) [6646040-2](#) [6651939-1](#) [6766604-1](#) [120959-1](#) [1393557-2](#) [1393532-2](#) [1393532-3](#) [1393532-4](#)  
[1393557-1](#) [1600812-5](#) [1-6450861-2](#) [1744132-7](#) [1761122-1](#) [1766250-1](#) [1892109-1](#) [2-6450860-5](#) [2-6450870-0](#) [1-6450161-4](#) [1-6450850-6](#) [1-](#)  
[6450869-6](#) [1645526-2](#) [1-6600130-0](#) [2005243-2](#) [377-0020-11130](#) [TE34-12-16P-F0](#) [51700-10201602AALF](#) [5-6450830-6](#) [5646956-4](#) [377-](#)  
[0080-11131A](#) [4-6450830-9](#) [4-6600333-3](#) [10125416-4050LF](#) [10130248-005LF](#) [6600320-3](#) [3-6450860-5](#) [1888123-2](#) [6450166-1](#) [6643978-1](#)  
[6766605-1](#) [701-15-02109](#) [N11444](#) [6651938-1](#) [6450810-7](#) [46437-1112](#) [1-1589677-8](#) [5646956-5](#)