

4

3

2

1

THIS DRAWING IS UNPUBLISHED. RELEASED FOR PUBLICATION --. -- . ALL RIGHTS RESERVED.

PROJECT	PRJ-16-000909157
PART NO.	X-2308272-X
DESCRIPTION	CABLE CLAMPS
CUSTOMER	GENERAL MARKET

REVISIONS					
P	LTR	DESCRIPTION	DATE	DWN	APVD
	A1	REVISED PER ECR-16-013123	20SEP2016	KK	GG

1-2308272-1

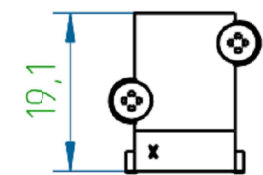
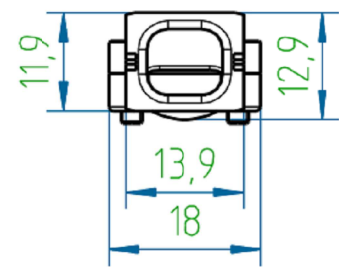

1-2308272-2

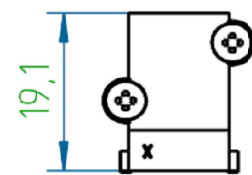
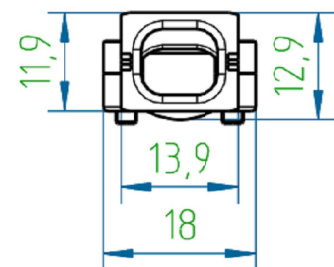

1-2308272-4

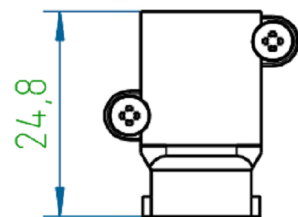
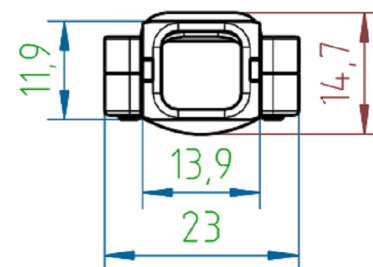

1-2308272-5

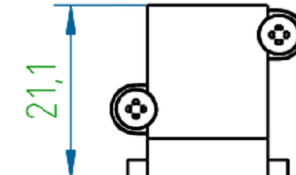
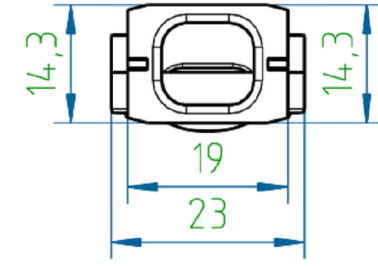

1-2308272-6

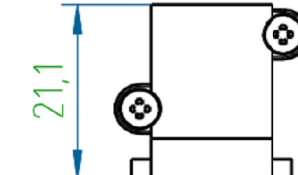
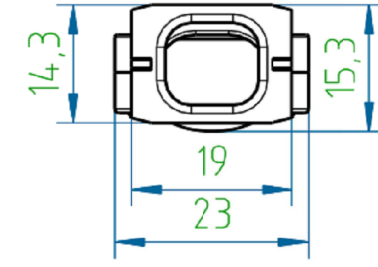

1-2308272-7

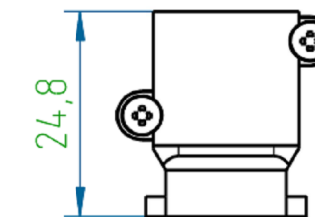
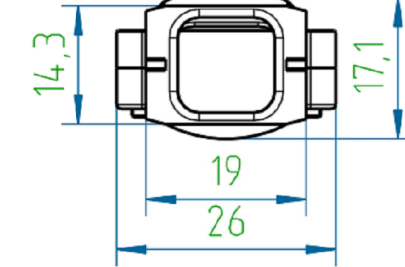

1-2308272-3

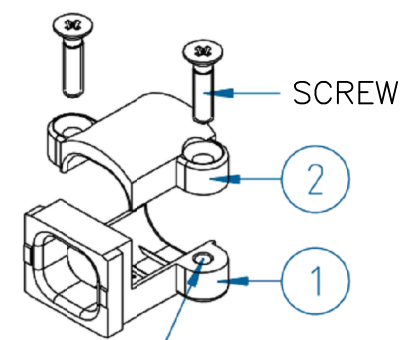
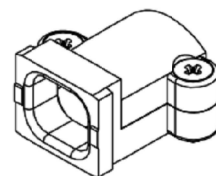
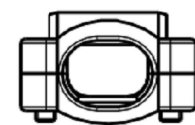
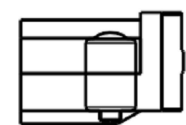
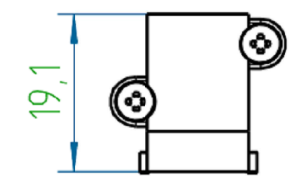
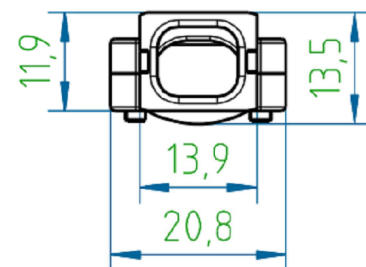

thread M2,5

NOTES:

- FINISH:
1-2308272-1 TO 1-2308272-7 - CASE RAW.
1-2308272-8 TO 2-2308272-4 - CASE NICKEL-PLATED.
- SCREWS ZINC-PLATED.
- TEMPERATURE RANGE: -40°C TO +90°C.

THIS DRAWING IS A CONTROLLED DOCUMENT.		DWN KIRAN K 26JUL2016		
DIMENSIONS: mm		CHK GUNASEKHAR G 26JUL2016		
TOLERANCES UNLESS OTHERWISE SPECIFIED: DIN ISO 2768 m		APVD GUNASEKHAR G 26JUL2016	CABLE CLAMPS	
		PRODUCT SPEC	SIZE CAGE CODE DRAWING NO	
MATERIAL		APPLICATION SPEC	RESTRICTED TO	
FINISH		WEIGHT	A2 00779 C=2308272	
		CUSTOMER DRAWING	SCALE NTS	SHEET 1 of 2 REV A1

THIS DRAWING IS UNPUBLISHED.

RELEASED FOR PUBLICATION

-. - .

© COPYRIGHT - By -

ALL RIGHTS RESERVED.

REVISIONS

P	LTR	DESCRIPTION	DATE	DWN	APVD
-	-	SEE SHEET 1	-	-	-

7	2-2308272-4	CABLE CLAMP7	CABLE CLAMP BOTTOM	CABLE CLAMP UPPER	5	125	14-16	9-10	7.5-8.5	6.5-8	20
6	2-2308272-3	CABLE CLAMP6	CABLE CLAMP BOTTOM	CABLE CLAMP UPPER	5	100	11-14	7-8	6-7	5-6.5	16
5	2-2308272-2	CABLE CLAMP5	CABLE CLAMP BOTTOM	CABLE CLAMP UPPER	5	100	8-10	5-7	4-5	-	21
4	2-2308272-1	CABLE CLAMP4	CABLE CLAMP BOTTOM	CABLE CLAMP UPPER	1-4	85	11-14	7-8	6-7	5-6	16
3	2-2308272-0	CABLE CLAMP3	CABLE CLAMP BOTTOM	CABLE CLAMP UPPER	1-4	75	9-12	6-7	5-6	4-5	12
2	1-2308272-9	CABLE CLAMP2	CABLE CLAMP BOTTOM	CABLE CLAMP UPPER	1-4	65	7-10	5-6	4-4.5	-	12
1	1-2308272-8	CABLE CLAMP1	CABLE CLAMP BOTTOM	CABLE CLAMP UPPER	1-4	65	4-7	4-5	3.5-4	-	14
SIZE	PART NO: (CASE Ni-PLATED)	DESCRIPTION (CASE Ni-PLATED)	POS. 1	POS. 2	AVAILABLE IN THE HOODS SIZE	WINDOWS FOR LACES, mm ²	FOR CABLE DIAMETER, mm				WEIGHT, g
			SUB-PART DESCRIPTION				1 CABLE	2 CABLE	3 CABLE	4 CABLE	

7	1-2308272-7	CABLE CLAMP7	CABLE CLAMP BOTTOM	CABLE CLAMP UPPER	5	125	14-16	9-10	7.5-8.5	6.5-8	20
6	1-2308272-6	CABLE CLAMP6	CABLE CLAMP BOTTOM	CABLE CLAMP UPPER	5	100	11-14	7-8	6-7	5-6.5	16
5	1-2308272-5	CABLE CLAMP5	CABLE CLAMP BOTTOM	CABLE CLAMP UPPER	5	100	8-10	5-7	4-5	-	21
4	1-2308272-4	CABLE CLAMP4	CABLE CLAMP BOTTOM	CABLE CLAMP UPPER	1-4	85	11-14	7-8	6-7	5-6	16
3	1-2308272-3	CABLE CLAMP3	CABLE CLAMP BOTTOM	CABLE CLAMP UPPER	1-4	75	9-12	6-7	5-6	4-5	12
2	1-2308272-2	CABLE CLAMP2	CABLE CLAMP BOTTOM	CABLE CLAMP UPPER	1-4	65	7-10	5-6	4-4.5	-	12
1	1-2308272-1	CABLE CLAMP1	CABLE CLAMP BOTTOM	CABLE CLAMP UPPER	1-4	65	4-7	4-5	3.5-4	-	14
SIZE	PART NO: (CASE RAW)	DESCRIPTION (CASE RAW)	POS. 1	POS. 2	AVAILABLE IN THE HOODS SIZE	WINDOWS FOR LACES, mm ²	FOR CABLE DIAMETER, mm				WEIGHT, g
			SUB-PART DESCRIPTION				1 CABLE	2 CABLE	3 CABLE	4 CABLE	

THIS DRAWING IS A CONTROLLED DOCUMENT.		DWN KIRAN K 26JUL2016	 TE Connectivity	
DIMENSIONS: mm		CHK GUNASEKHAR G 26JUL2016		
TOLERANCES UNLESS OTHERWISE SPECIFIED: DIN ISO 2768 m		APVD GUNASEKHAR G 26JUL2016	NAME CABLE CLAMPS	
0 PLC ± - 1 PLC ± - 2 PLC ± - 3 PLC ± - 4 PLC ± - ANGLES ± -		PRODUCT SPEC -	SIZE A2	
MATERIAL -		APPLICATION SPEC -	CAGE CODE 00779	DRAWING NO G=2308272
FINISH -		WEIGHT -	RESTRICTED TO -	SCALE NTS
CUSTOMER DRAWING			SHEET 2 of 2	REV A1

2308272

X-ON Electronics

Largest Supplier of Electrical and Electronic Components

Click to view similar products for [D-Sub Tools & Hardware](#) category:

Click to view products by [TE Connectivity](#) manufacturer:

Other Similar products are found below :

[000-01-09-132](#) [000-01-21-132](#) [000-01-31-162](#) [572019-00105-70](#) [000-01-37-162](#) [621-250-113-115](#) [D110550-2](#) [D20418-137](#) [780-518-50SG6-WS](#) [86552009](#) [86553115TLF](#) [86553117TLF](#) [1230032-1](#) [1-5021101-2](#) [15-000050](#) [1589283-4](#) [160-000-005R031](#) [16-000230](#) [160-025-004R031](#) [160-000-137R000](#) [160-020-209R000](#) [160X10909X](#) [164C03939A](#) [177-505-A-2-2](#) [1-966830-8](#) [21018-6](#) [2-1393560-9](#) [JS-1000](#) [L17D204182M3E](#) [L17D53018](#) [300X10779X](#) [160X10189X](#) [160X10419X](#) [162-000-050R000](#) [21018-5](#) [212561-3](#) [248C21550X](#) [CF15P](#) [QLOCKPOST-2](#) [D110277](#) [500-008NF1K-01](#) [500-008NF3R3KS-01](#) [500-017M09FN](#) [500-017M15MHN](#) [500-024M1](#) [500-068M3](#) [5-1393561-5](#) [C115373-0001](#) [C115373-0002](#) [3342-4-KIT](#)