

THIS DRAWING IS UNPUBLISHED. RELEASED FOR PUBLICATION 2018
 © COPYRIGHT 2018 BY - ALL RIGHTS RESERVED.

REVISIONS					
P	LTR	DESCRIPTION	DATE	DWN	APVD
	B	LOGO CHANGE; RESIN MARK ADD	08AUG2018	F.Z	R.B

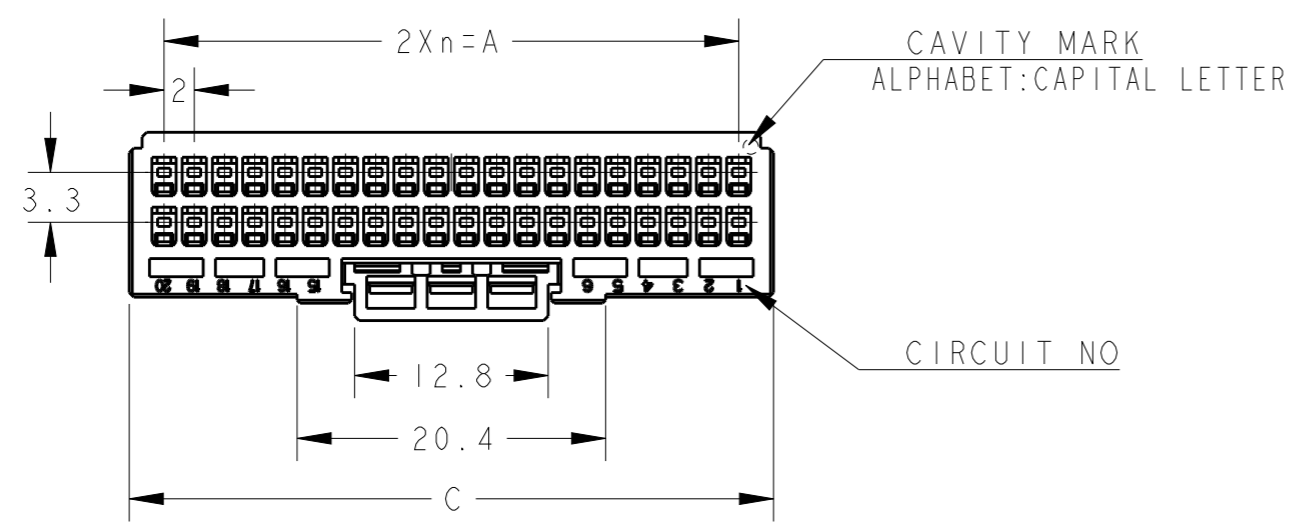

1. MATERIAL: GLASS FILED THERMO PLASTIC POLYESTER(94V-0), COLOR: BLACK
2. THE SHAPE, SIZE AND POSITION OF THE CHARACTER SHOW THE OUTLINE. THEY DON'T SHOW DETAILS.
3. THE KEYING ARRANGEMENT OF "Y" IS SYMMETRIC WITH "X".

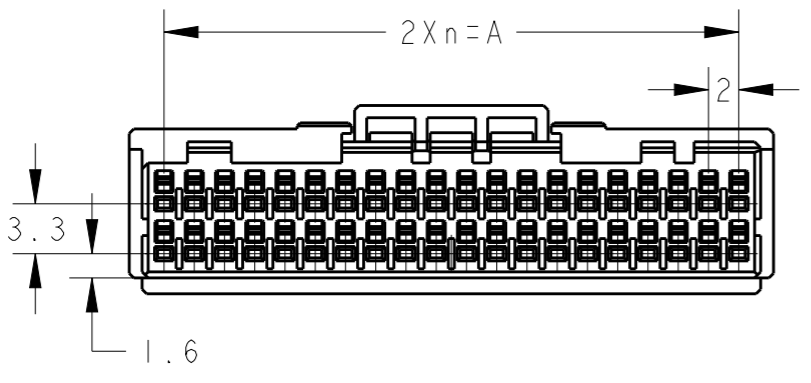
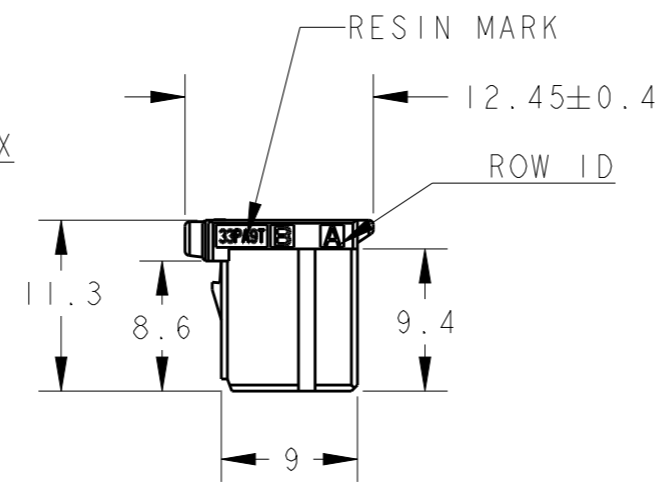
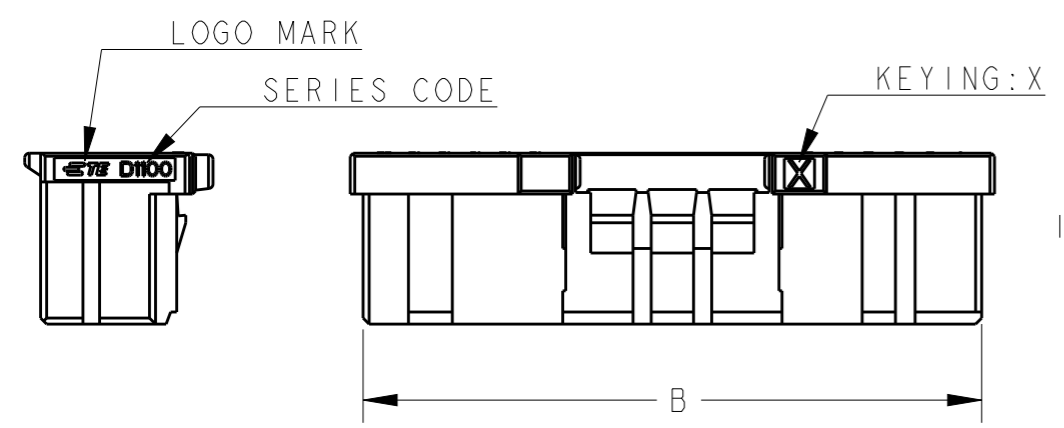

40	Y	19	38.0	40.9	42.6	2-2333134-0
40	X	19	38.0	40.9	42.6	1-2333134-0
34	Y	16	32.0	34.9	36.6	2-2333134-7
34	X	16	32.0	34.9	36.6	1-2333134-7
32	X	15	30.0	32.9	34.6	1-2333134-6
30	X	14	28.0	30.9	32.6	1-2333134-5
28	X	13	26.0	28.9	30.6	1-2333134-4
26	Y	12	24.0	26.9	28.6	2-2333134-3
26	X	12	24.0	26.9	28.6	1-2333134-3
24	X	11	22.0	24.9	26.6	1-2333134-2
22	X	10	20.0	22.9	24.6	1-2333134-1
POS	KEY	n	A	B	C	PART NO

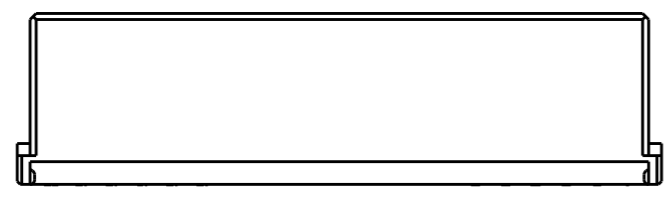

40POS(X-KEY): 1-2333134-0

THIS DRAWING IS A CONTROLLED DOCUMENT.		DWN Fisher ZHU 09-Aug-18	TE Connectivity					
DIMENSIONS: mm		CHK Rick BIAN 09-Aug-18				NAME DYNAMIC D1100D 2.0mm PITCH REC HSG 22-40POS		
TOLERANCES UNLESS OTHERWISE SPECIFIED: ±0.3, ±5°		APVD Rick BIAN 09-Aug-18				PRODUCT SPEC 108-78268, 78298		
0 PLC ± 1 PLC ±0.3 2 PLC ±0.10 3 PLC ±0.001 4 PLC ±0.0001 ANGLES ±		APPLICATION SPEC 114-5377				RESTRICTED TO -		
MATERIAL		FINISH	WEIGHT	SIZE A3	CAGE CODE 00779	DRAWING NO C-2333134		
CUSTOMER DRAWING			SCALE 2:1	SHEET 1 OF 3	REV B			

REVISIONS

P	LTR	DESCRIPTION	DATE	DWN	APVD
		SEE SHEET 1			

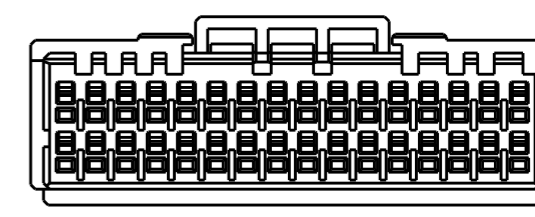
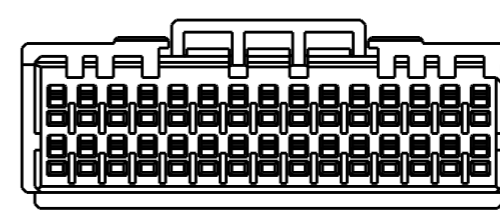
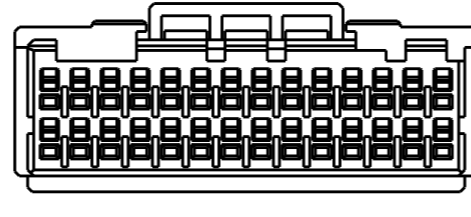
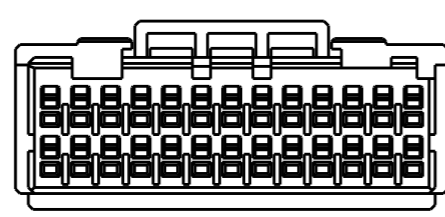
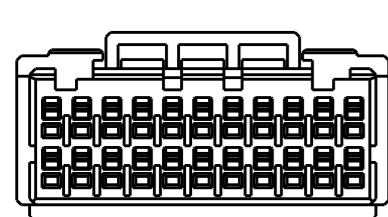
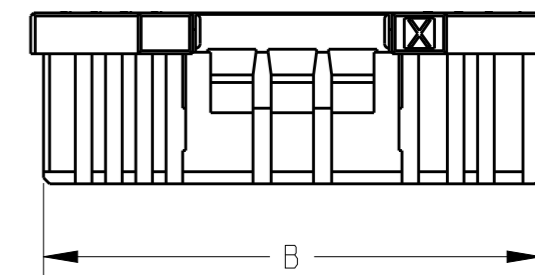
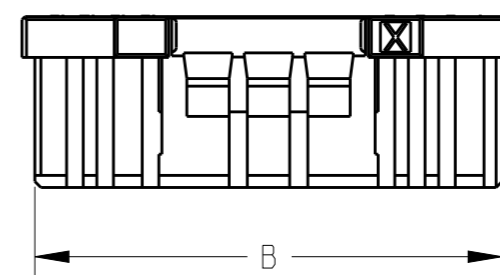
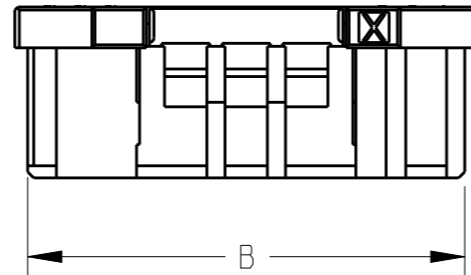
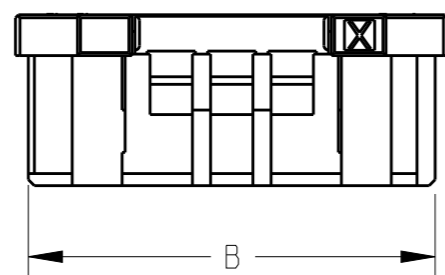
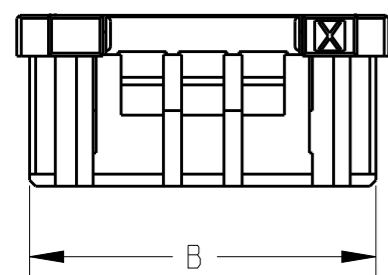
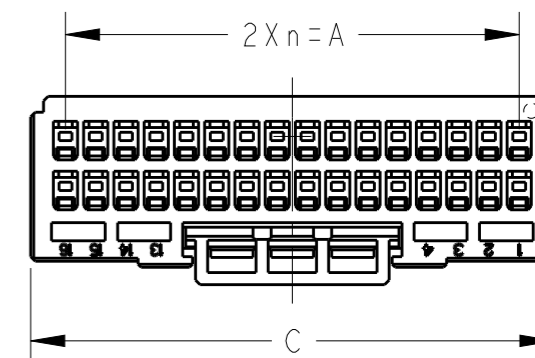
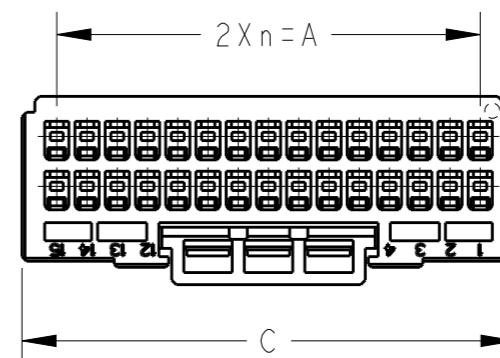
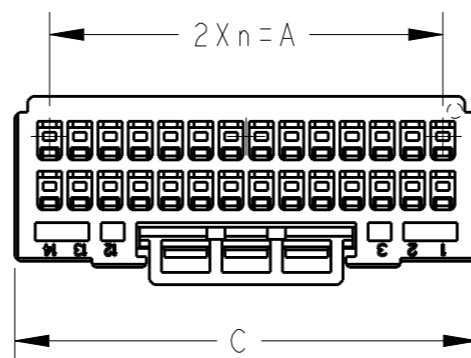
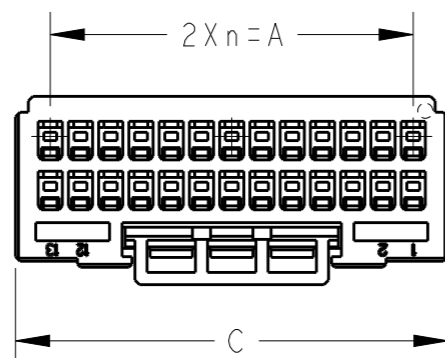
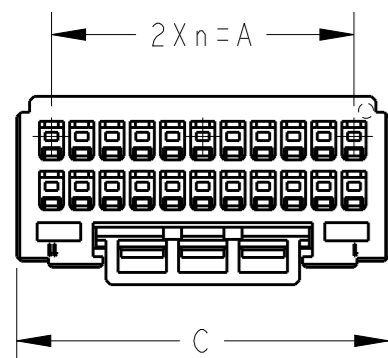

22POS(X-KEY): I-2333134-1

26POS(X-KEY): I-2333134-3

28POS(X-KEY): I-2333134-4

30POS(X-KEY): I-2333134-5

32POS(X-KEY): I-2333134-6

THIS DRAWING IS A CONTROLLED DOCUMENT.		DWN Fisher ZHU 09-Aug-18	 TE Connectivity	
DIMENSIONS: mm		CHK Rick BIAN 09-Aug-18		
TOLERANCES UNLESS OTHERWISE SPECIFIED:		APVD Rick BIAN 09-Aug-18	NAME DYNAMIC D1100D 2.0mmPITCH	
0 PLC ±		PRODUCT SPEC 108-78268,78298	REC HSG	
2 PLC ±		APPLICATION SPEC 114-5377	22-40POS	
3 PLC ±		WEIGHT -	SIZE A3	CAGE CODE 00779
4 PLC ±		CUSTOMER DRAWING	DRAWING NO C-2333134	RESTRICTED TO -
ANGLES ±			SCALE 2:1	SHEET 2 OF 3
FINISH -				REV B

SEE SHEET 1 OF 3

THIS DRAWING IS UNPUBLISHED.

RELEASED FOR PUBLICATION

2018

© COPYRIGHT 2018 BY -

ALL RIGHTS RESERVED.

REVISIONS

P	LTR	DESCRIPTION	DATE	DWN	APVD
		SEE SHEET 1			

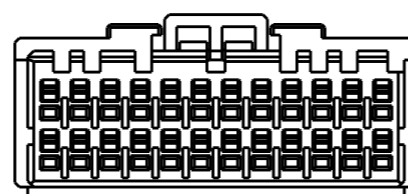
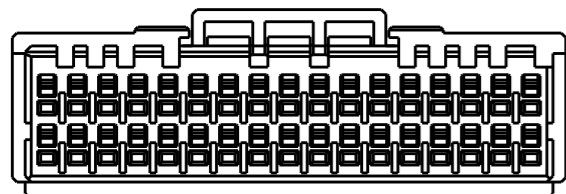
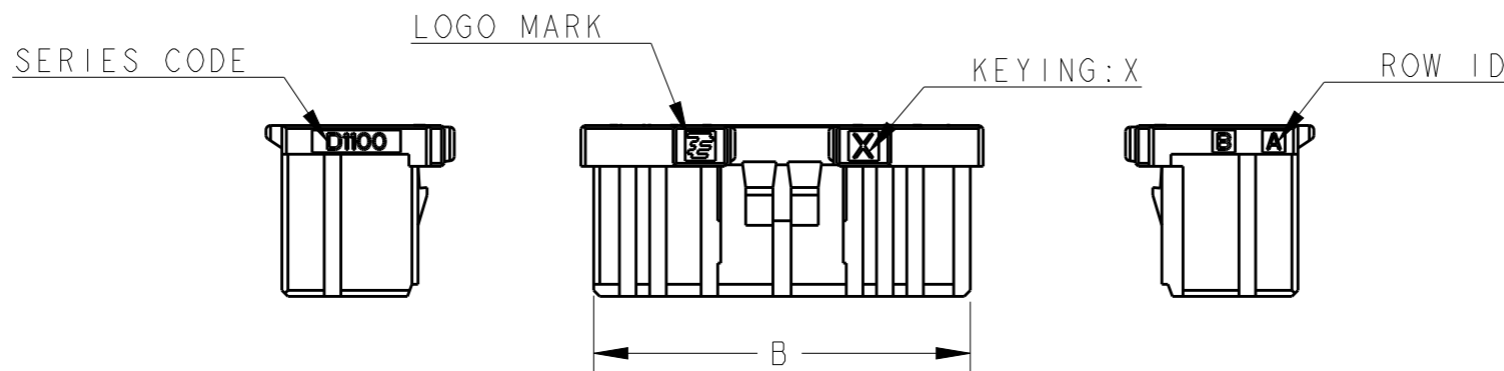
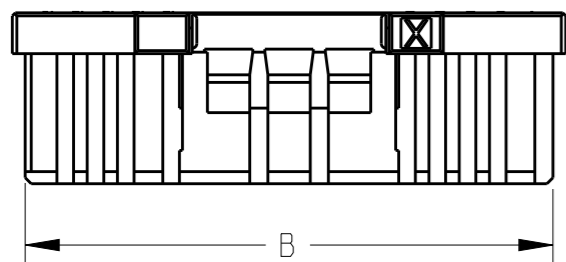
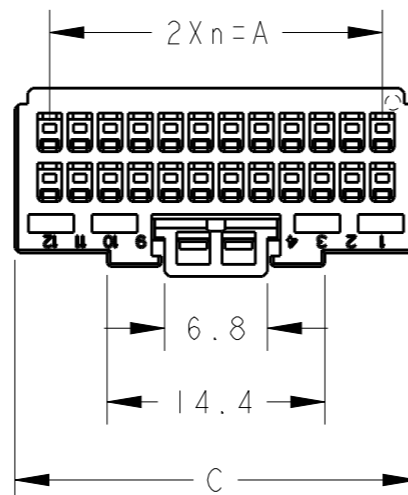
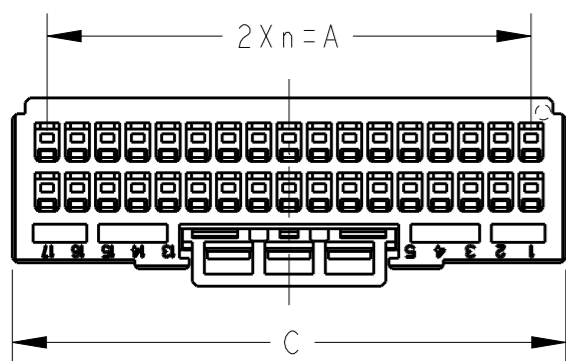

34POS(X-KEY): 1-2333134-7

24POS(X-KEY): 1-2333134-2

THIS DRAWING IS A CONTROLLED DOCUMENT.		DWN Fisher ZHU 09-Aug-18	 TE Connectivity	
DIMENSIONS: mm		CHK Rick BIAN 09-Aug-18		
TOLERANCES UNLESS OTHERWISE SPECIFIED:		APVD Rick BIAN 09-Aug-18	NAME DYNAMIC D1100D 2.0mmPITCH	
0 PLC ±		PRODUCT SPEC 108-78268,78298	REC HSG	
2 PLC ±		APPLICATION SPEC 114-5377	22-40POS	
3 PLC ±		WEIGHT -	SIZE A3	CAGE CODE 00779
4 PLC ±		CUSTOMER DRAWING	DRAWING NO C-2333134	RESTRICTED TO -
ANGLES ±		SCALE 2:1	SHEET 3 OF 3	REV B
MATERIAL -				
FINISH -				

SEE SHEET 1 OF 3

X-ON Electronics

Largest Supplier of Electrical and Electronic Components

Click to view similar products for [Rectangular MIL Spec Connectors](#) category:

Click to view products by [TE Connectivity](#) manufacturer:

Other Similar products are found below :

[891-011-15SA2-BSST](#) [CTS-S16/16](#) [65002-062](#) [CY4602-000](#) [732-8020-01](#) [77058-22-55PN](#) [81542-20](#) [86.030.0053.0](#) [1241346-1](#) [RM252-020-311-2900](#) [DMC-M 08-16 SA](#) [1589051-4](#) [MSO34MPK1E1](#) [BACC65CAMA](#) [BACC65CP1PN](#) [BACI10BC0816PNBA](#) [HSB-D4S03DM222X](#) [2217548-1](#) [891-006-9PS-BST1T](#) [891-009-15SA2-BRT1T](#) [27963-20T12](#) [SIM2N40NC3](#) [SIM2S100A](#) [1604996-2](#) [SMD25PN90L-4055](#) [1900ND08S1B00A](#) [22628-10-6P-791](#) [33526M11-08PD](#) [RE04-212S](#) [M32139/03-G05SN](#) [CTD160E01F-6148](#) [CTJ112E03B](#) [CTJ122E02D-8000](#) [CTJ-3D-12](#) [CTJ920E06N-513](#) [CTJ920E12N-513](#) [CTL-16-090](#) [RM300-000-581-0000](#) [CY4600-000](#) [CY4601-000](#) [38111-14-15SN](#) [38112-14-15PN](#) [MMA23-0111R1](#) [MMD25-0071P1](#) [33516062020](#) [33526M11-08PE](#) [DMC-M99-01AN](#) [Y59113WE20PNV00300](#) [ZPF000000000106310](#) [105979-31](#)