

P	LTR	DESCRIPTION	DATE	DWN	APVD
F		REVISED	16MAR2021	M.T	H.T

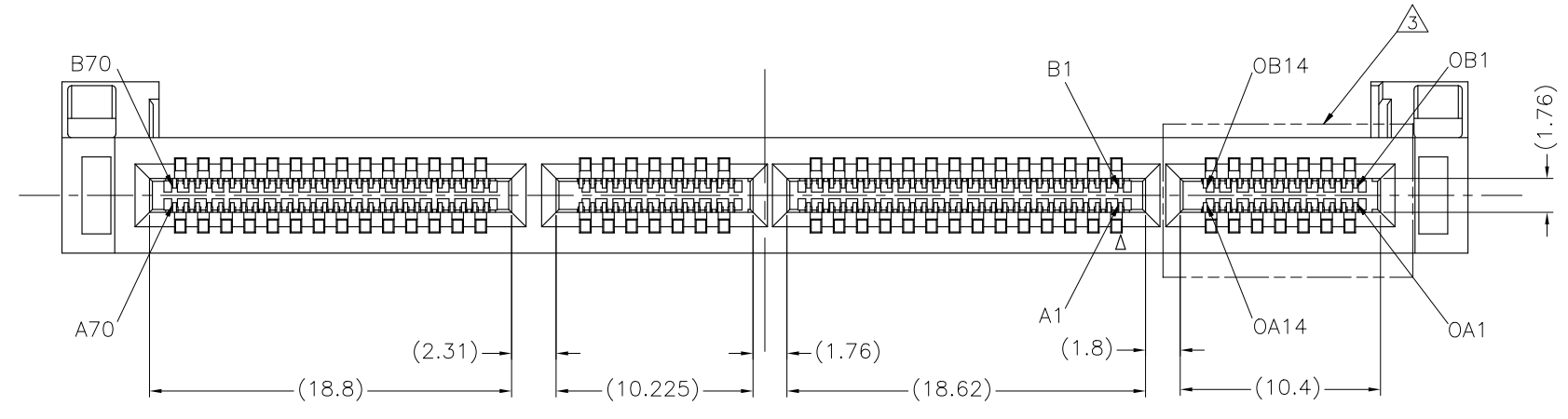
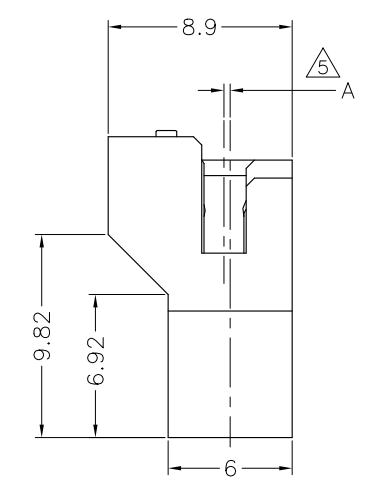
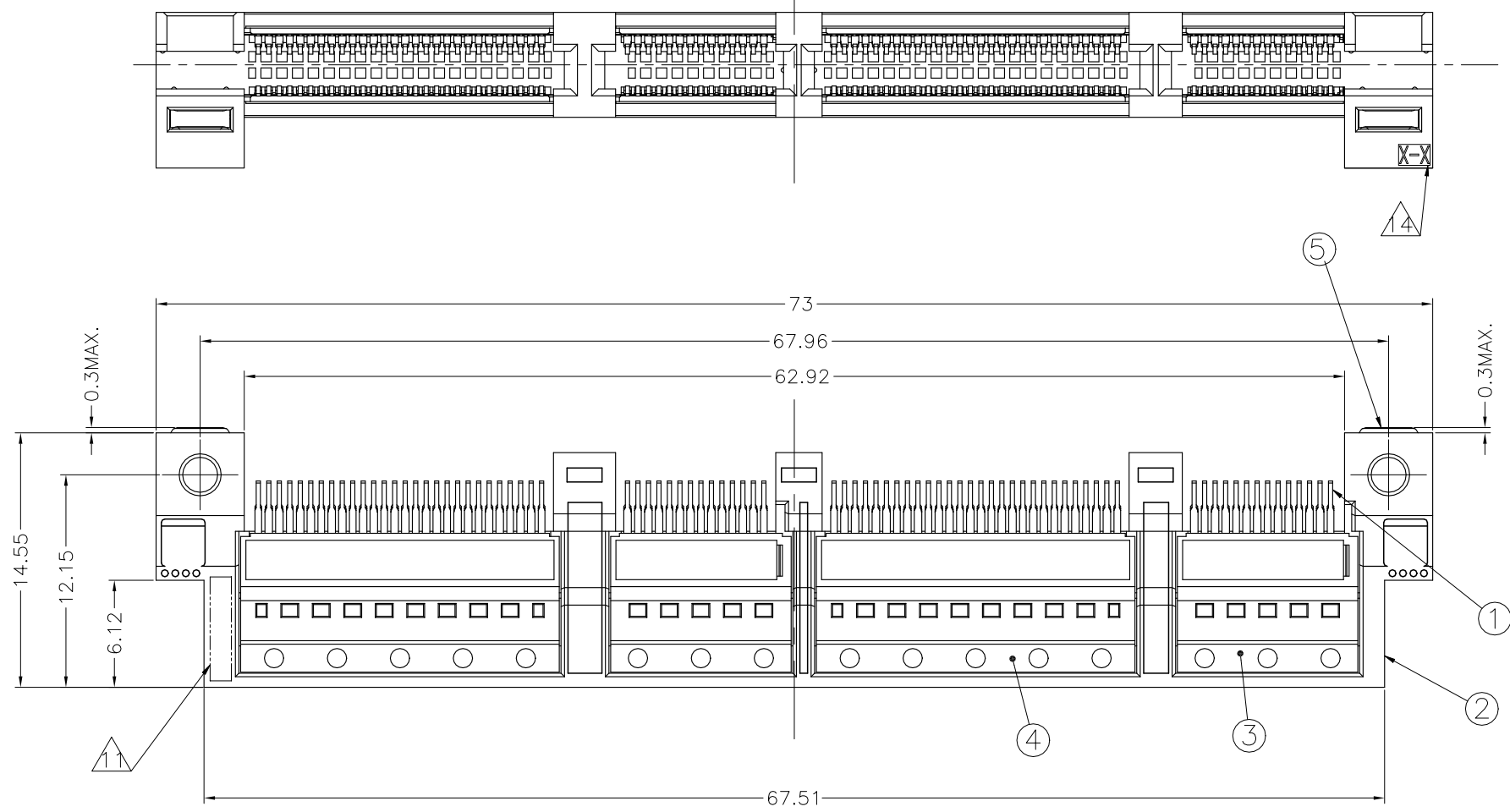

PLATING	PACKAGING	SCREW INCLUSION	△5 DIM A	△4 DIM B (HOST BOARD THICKNESS)	PARTS No.
0.76 μm Au	SOFT TRAY	YES	0	1.57 ±0.15	2340321-1
		NO	0	1.57 ±0.15	2340321-3
		YES	0.3	1.93 ±0.19	1-2340321-2
		NO	0.3	1.93 ±0.19	1-2340321-4
		YES	0	2.11 ±0.21	1-2340321-6
		NO	0	2.36 ±0.23	2-2340321-1
	NO	0	2.36 ±0.23	2-2340321-3	
	YES	0	2.55 ±0.23, 2.6 ±0.23	4-2340321-1	
	NO	0	2.55 ±0.23, 2.6 ±0.23	4-2340321-3	
	YES	0	2.79 ±0.23	4-2340321-6	
	YES	0	1.57 ±0.15	5-2340321-1	
	NO	0	1.57 ±0.15	5-2340321-3	
	YES	0.3	1.93 ±0.19	6-2340321-2	
	NO	0.3	1.93 ±0.19	6-2340321-4	
	YES	0	2.11 ±0.21	2340321-6	
	YES	0	2.36 ±0.23	7-2340321-1	
	NO	0	2.36 ±0.23	7-2340321-3	
	YES	0	2.55 ±0.23, 2.6 ±0.23	9-2340321-1	
YES	0	2.79 ±0.23	3-2340321-6		
EMBOSS TAPE	NO	0.3	1.93 ±0.19	6-2340321-9	
EMBOSS TAPE	YES	0.3	1.93 ±0.19	6-2340321-7	

AS SHOWN : -1, -3, -6, 1--2, 1--4, 1--6, 2--1, 2--3, 3--6, 4--1, 4--3, 4--6, 5--1, 5--3, 6--2, 6--4, 6--7, 6--9, 7--1, 7--3, 9--1

QTY	NAME	ITEM No.
2	M2 SCREW	⑤
2	M2 NUT PLATE	⑤
4	COVER HOUSING 28P	④
4	COVER HOUSING 14P	③
1	HOUSING	②
168	CONTACT	①

THIS DRAWING IS A CONTROLLED DOCUMENT.

DIMENSIONS: mm

TOLERANCES UNLESS OTHERWISE SPECIFIED: ±0.3

0-PLG ±

1-PLG ±

2-PLG ±

3-PLG ±

4-PLG ±

ANGLES ±

FINISH

DWN M.TANAKA 30JUL2018

CHK J.TSUJI 30JUL2018

APVD K.KOBAYASHI 30JUL2018

PRODUCT SPEC 108-140197

APPLICATION SPEC 114-78033

WEIGHT 0

CUSTOMER DRAWING

TE Connectivity Ltd.

168 POSITION SLIVER 2.0 STRADDLE MOUNT

SIZE A2 CAGE CODE 00779 DRAWING NO. C=2340321 RESTRICTED TO

SCALE 4:1 SHEET 1 of 6 REV F

REVISIONS					
P	LTR	DESCRIPTION	DATE	DWN	APVD
-	-	SEE SHEET 1	-	-	-

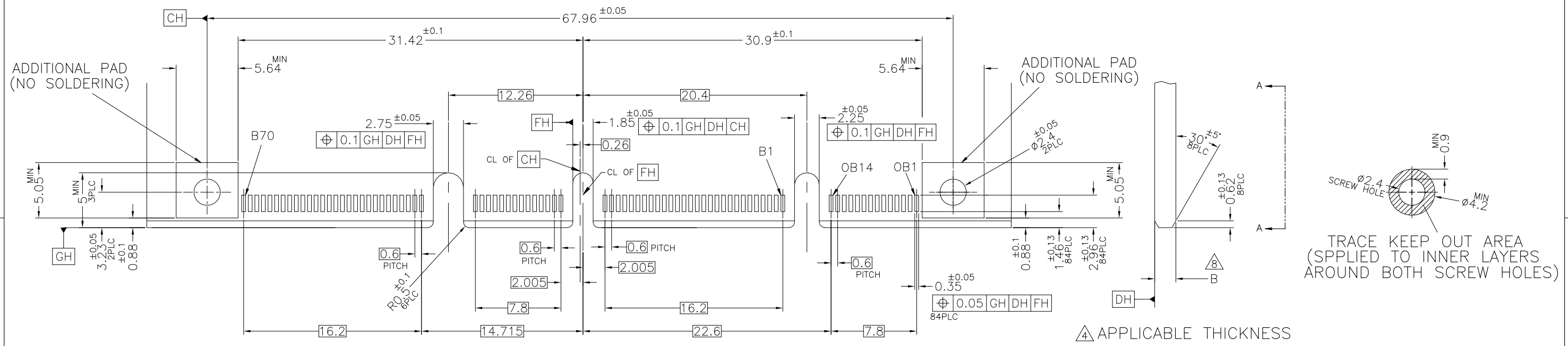

REFERENCE HOST BOARD LAYOUT

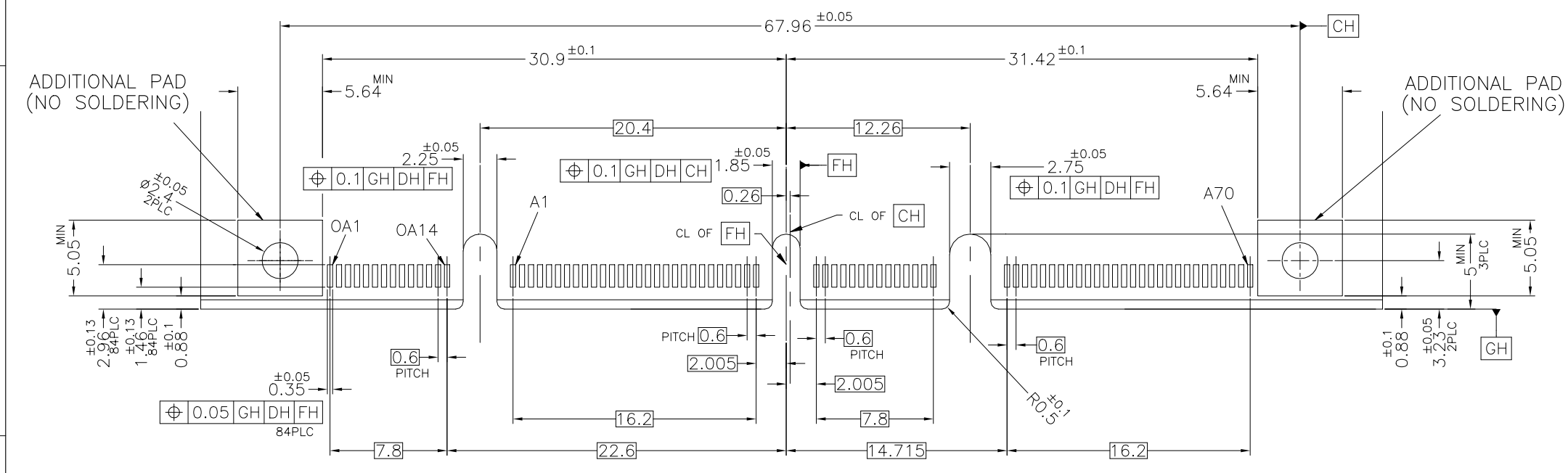

VIEW A-A

HOST BOARD LAYOUT

THIS DRAWING IS A CONTROLLED DOCUMENT.		DWN	TE Connectivity Ltd.		
DIMENSIONS: mm		CHK			
TOLERANCES UNLESS OTHERWISE SPECIFIED: ±0.3		APVD	NAME		
0-PLC ± 1-PLC ± 2-PLC ± 3-PLC ± 4-PLC ±		PRODUCT SPEC	168 POSITION SLIVER 2.0 STRADDLE MOUNT		
MATERIAL		APPLICATION SPEC	SIZE	CAGE CODE	DRAWING NO
FINISH		WEIGHT	A2	00779	C=2340321
		CUSTOMER DRAWING	SCALE	SHEET	REV
			4:1	2 of 6	F

4

3

2

1

© - TE Connectivity. All Rights Reserved.

REVISIONS

P	LTR	DESCRIPTION	DATE	DWN	APVD
-	-	SEE SHEET 1	-	-	-

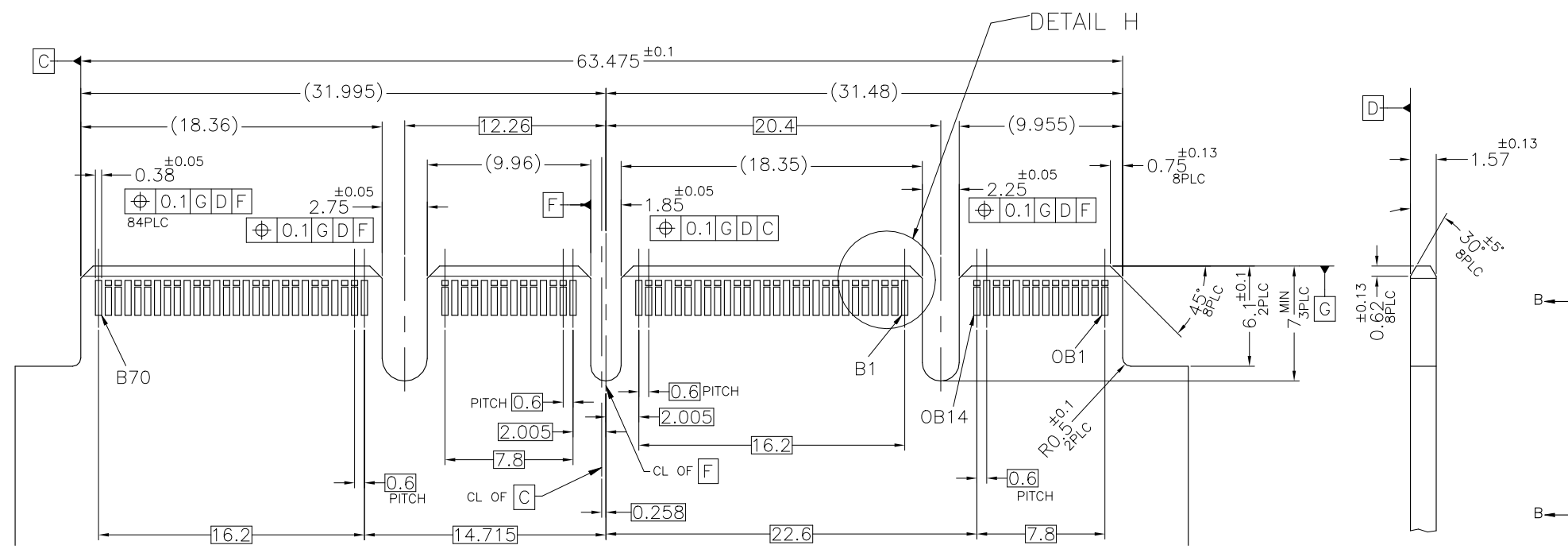

REFERENCE AIC BOARD LAYOUT

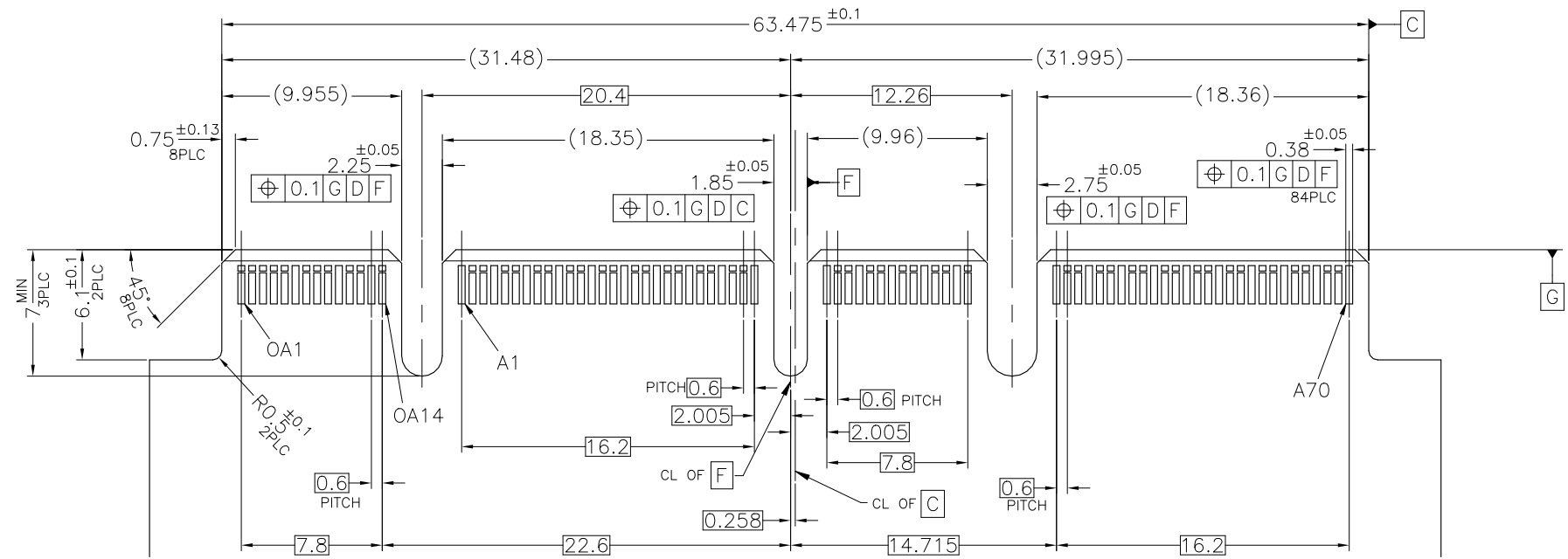

VIEW B-B

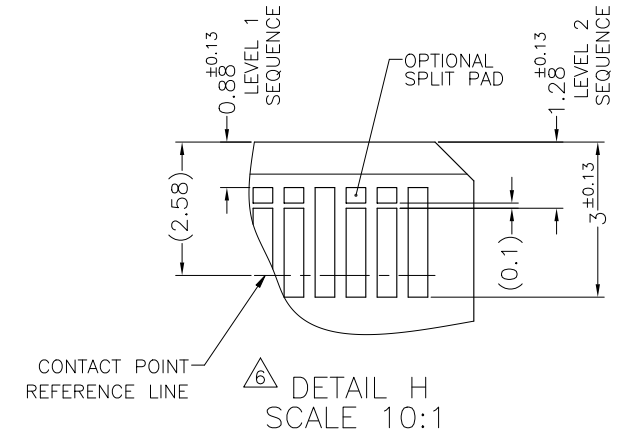

THIS DRAWING IS A CONTROLLED DOCUMENT.		DWN	TE Connectivity Ltd.		
DIMENSIONS: mm		CHK	NAME		
TOLERANCES UNLESS OTHERWISE SPECIFIED: ±0.3		APVD	188 POSITION SLIVER 2.0 STRADDLE MOUNT		
0-PLC ±		PRODUCT SPEC	SIZE	CAGE CODE	DRAWING NO
1-PLC ±		APPLICATION SPEC	A2	00779	C=2340321
2-PLC ±		WEIGHT	SCALE	SHEET	REV
3-PLC ±		CUSTOMER DRAWING	4:1	3 of 6	F
4-PLC ±					
ANGLES ±					
FINISH					

REVISIONS					
P	LTR	DESCRIPTION	DATE	DWN	APVD
-	-	SEE SHEET 1	-	-	-

















CONNECTOR CONTACT IDENTIFICATION

CONTACT NUMBER	SIDE A	SIDE B
1	GROUND	GROUND
2	SIGNAL	SIGNAL
3	SIGNAL	SIGNAL
4	GROUND	GROUND
5	SIGNAL	SIGNAL
6	SIGNAL	SIGNAL
7	GROUND	GROUND
8	SIGNAL	SIGNAL
9	SIGNAL	SIGNAL
10	GROUND	GROUND
11	SIGNAL	SIGNAL
12	SIGNAL	SIGNAL
13	GROUND	GROUND
14	SIGNAL	SIGNAL
15	SIGNAL	SIGNAL
16	GROUND	GROUND
17	SIGNAL	SIGNAL
18	SIGNAL	SIGNAL
19	GROUND	GROUND
20	SIGNAL	SIGNAL
21	SIGNAL	SIGNAL
22	GROUND	GROUND
23	SIGNAL	SIGNAL
24	SIGNAL	SIGNAL
25	GROUND	GROUND
26	SIGNAL	SIGNAL
27	SIGNAL	SIGNAL
28	GROUND	GROUND
29	GROUND	GROUND
30	SIGNAL	SIGNAL
31	SIGNAL	SIGNAL
32	GROUND	GROUND
33	SIGNAL	SIGNAL
34	SIGNAL	SIGNAL
35	GROUND	GROUND

CONTACT NUMBER	SIDE A	SIDE B
36	SIGNAL	SIGNAL
37	SIGNAL	SIGNAL
38	GROUND	GROUND
39	SIGNAL	SIGNAL
40	SIGNAL	SIGNAL
41	GROUND	GROUND
42	GROUND	GROUND
43	GROUND	GROUND
44	SIGNAL	SIGNAL
45	SIGNAL	SIGNAL
46	GROUND	GROUND
47	SIGNAL	SIGNAL
48	SIGNAL	SIGNAL
49	GROUND	GROUND
50	SIGNAL	SIGNAL
51	SIGNAL	SIGNAL
52	GROUND	GROUND
53	SIGNAL	SIGNAL
54	SIGNAL	SIGNAL
55	GROUND	GROUND
56	SIGNAL	SIGNAL
57	SIGNAL	SIGNAL
58	GROUND	GROUND
59	SIGNAL	SIGNAL
60	SIGNAL	SIGNAL
61	GROUND	GROUND
62	SIGNAL	SIGNAL
63	SIGNAL	SIGNAL
64	GROUND	GROUND
65	SIGNAL	SIGNAL
66	SIGNAL	SIGNAL
67	GROUND	GROUND
68	SIGNAL	SIGNAL
69	SIGNAL	SIGNAL
70	GROUND	GROUND

OCP CONTROLLED AREA

CONTACT NUMBER	SIDE A	SIDE B
O 1	GROUND	GROUND
O 2	SIGNAL	SIGNAL
O 3	SIGNAL	SIGNAL
O 4	GROUND	GROUND
O 5	SIGNAL	SIGNAL
O 6	SIGNAL	SIGNAL
O 7	GROUND	GROUND
O 8	SIGNAL	SIGNAL
O 9	SIGNAL	SIGNAL
O 10	GROUND	GROUND
O 11	SIGNAL	SIGNAL
O 12	SIGNAL	SIGNAL
O 13	GROUND	GROUND
O 14	GROUND	GROUND

- NOTE
-  HOUSING AND COVER: LCP, UL94-V0, BLACK.
 -  CONTACTS: COPPER ALLOY.
 -  GOLD PLATE ON CONTACT AREA.
 -  TIN PLATE ON SOLDER TAIL AREA.
 -  OA1~OA14 AND OB1~OB14 ARE CONTROLLED SECTION FOR OCP.
 -  APPLICABLE HOST BOARD THICKNESS
 -  OFFSET AMOUNT BETWEEN AIC BOARD AND HOST BOARD CENTER LINE.
 -  SEE MSA SPECIFICATION FOR ADDITIONAL PADDLE CARD LAYOUTS COMPATIBLE WITH THIS RECEPTACLE AND FOR OPTIONAL SPLIT CONTACT PAD LAYOUTS FOR THE PADDLE CARD. SPECIFICATION PINOUT MAY ALSO DESIGNATE PAD SEQUENCE DIFFERENT FROM ILLUSTRATION.
 -  POSITIONS DESIGNATED AS "SIGNAL" ARE RECOMMENDED LOCATIONS FOR HIGH SPEED DIFFERENTIAL PAIR SIGNALING. THESE LOCATIONS MAY ALSO BE USED FOR SUPPORTING SIDEBAND SIGNALS OR OTHER UTILITY PURPOSES. POSITIONS DESIGNATED AS "GROUND" ARE REQUIRED WHEN SUPPORTING HIGH SPEED DIFFERENTIAL SIGNALS. THESE LOCATIONS MAY ALSO BE USED FOR SIDEBAND SIGNALS OR OTHER UTILITY PUPOSES.
 -  CONTROLLED ACROSS PADS.
 -  THIS LAYOUT IS ADOPTED IN SFF-TA-1002
 -  SCREW IS ENCLOSED BY SEPARATE PACKING. SCREW SIZE: M2 SCREW LENGTH(REF): 6 HEAD SIZE(REF): $\phi 3.5$, 1.3HEIGHT
 -  DATE CODE MARKING.
 -  CONNECTOR MUST BE FIXED ON PCB BY SCREW AFTER SOLDERING.
 -  ALL CHAMFERED EDGES AND EDGE OF PADS SHALL BE FREE OF BURRS.
 -  HOUSING ID MARK

2340321

THIS DRAWING IS A CONTROLLED DOCUMENT.		DWN	TE Connectivity Ltd.	
DIMENSIONS: mm		CHK	168 POSITION SLIVER 2.0 STRADDLE MOUNT	
TOLERANCES UNLESS OTHERWISE SPECIFIED:		APVD	NAME	
0-PLC ±		PRODUCT SPEC	SIZE CAGE CODE DRAWING NO RESTRICTED TO	
1-PLC ±		APPLICATION SPEC	A2 00779 C=2340321	
2-PLC ±		WEIGHT	SCALE NTS SHEET 4 of 6 REV F	
3-PLC ±		CUSTOMER DRAWING		
4-PLC ±				
ANGLES ±				
FINISH				

4

3

2

1

© - TE Connectivity. All Rights Reserved.

REVISIONS					
P	LTR	DESCRIPTION	DATE	DWN	APVD
-	-	SEE SHEET 1	-	-	-

D
C
B
A

D
C
B
A

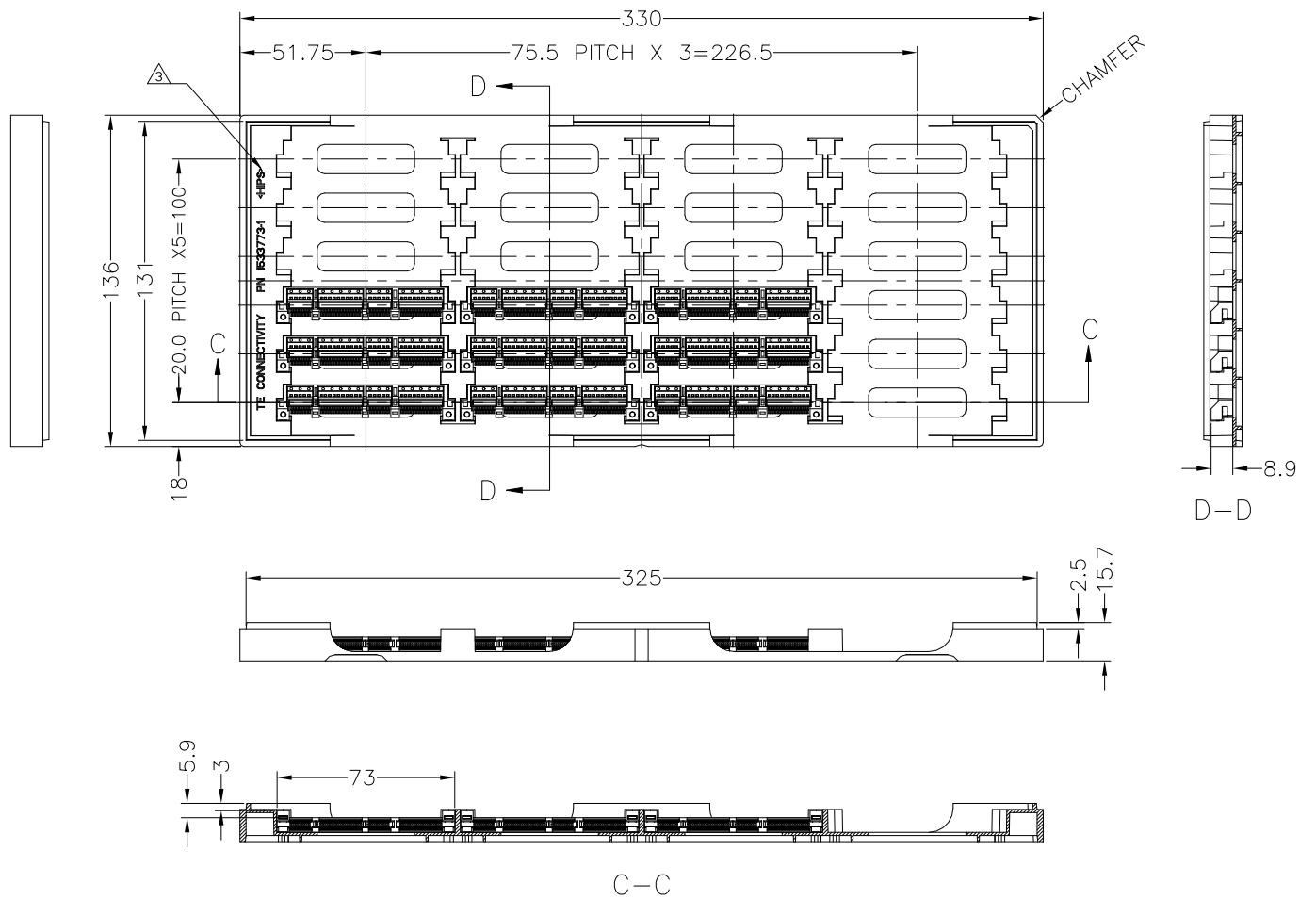
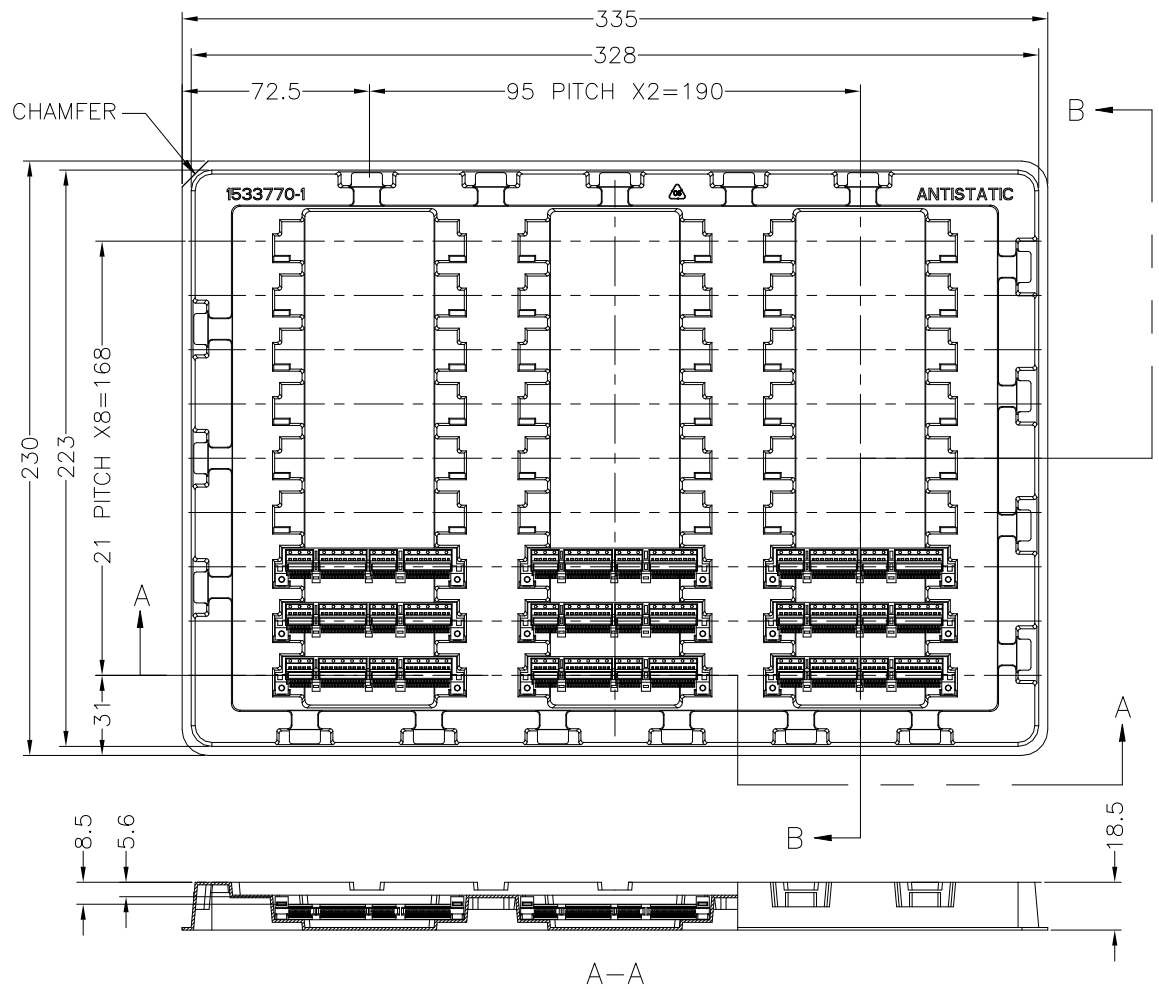

SOFT TRAY PACKAGING: -1,-3, 1--2, 1--4, 1--6, 2--1, 2--3, 4--1, 4--3, 4--6

HARD TRAY PACKAGING: -6, 3--6, 5--1, 5--3, 6--2, 6--4, 7--1, 7--3, 9--1

1. MATERIAL: HIPS, COLOR: NATURAL
2. QTY. : 9 X 3 = 27 POCKETS PER TRAY
3. TOLERANCES ON TRAY DIMENSIONS ARE REFERENCE

1. MATERIAL: HIPS, COLOR: BLACK
2. QTY. : 6 X 4 = 24 POCKETS PER TRAY
3. MARKING
4. TOLERANCES ON TRAY DIMENSIONS ARE REFERENCE

THIS DRAWING IS A CONTROLLED DOCUMENT.		DWN	TE Connectivity Ltd.	
DIMENSIONS: mm		CHK	NAME	
TOLERANCES UNLESS OTHERWISE SPECIFIED:		APVD	168 POSITION SLIVER 2.0 STRADDLE MOUNT	
<ul style="list-style-type: none"> 0-PLG ± 1-PLG ± 2-PLG ± 3-PLG ± 4-PLG ± ANGLES ± FINISH 		PRODUCT SPEC	SIZE	RESTRICTED TO
MATERIAL		APPLICATION SPEC	CAGE CODE	
		WEIGHT	DRAWING NO	
		CUSTOMER DRAWING	A2 00779	
		SCALE	NTS	
		SHEET	5 of 6	
		REV	F	

2340321

REVISIONS					
P	LTR	DESCRIPTION	DATE	DWN	APVD
-	-	SEE SHEET 1	-	-	-

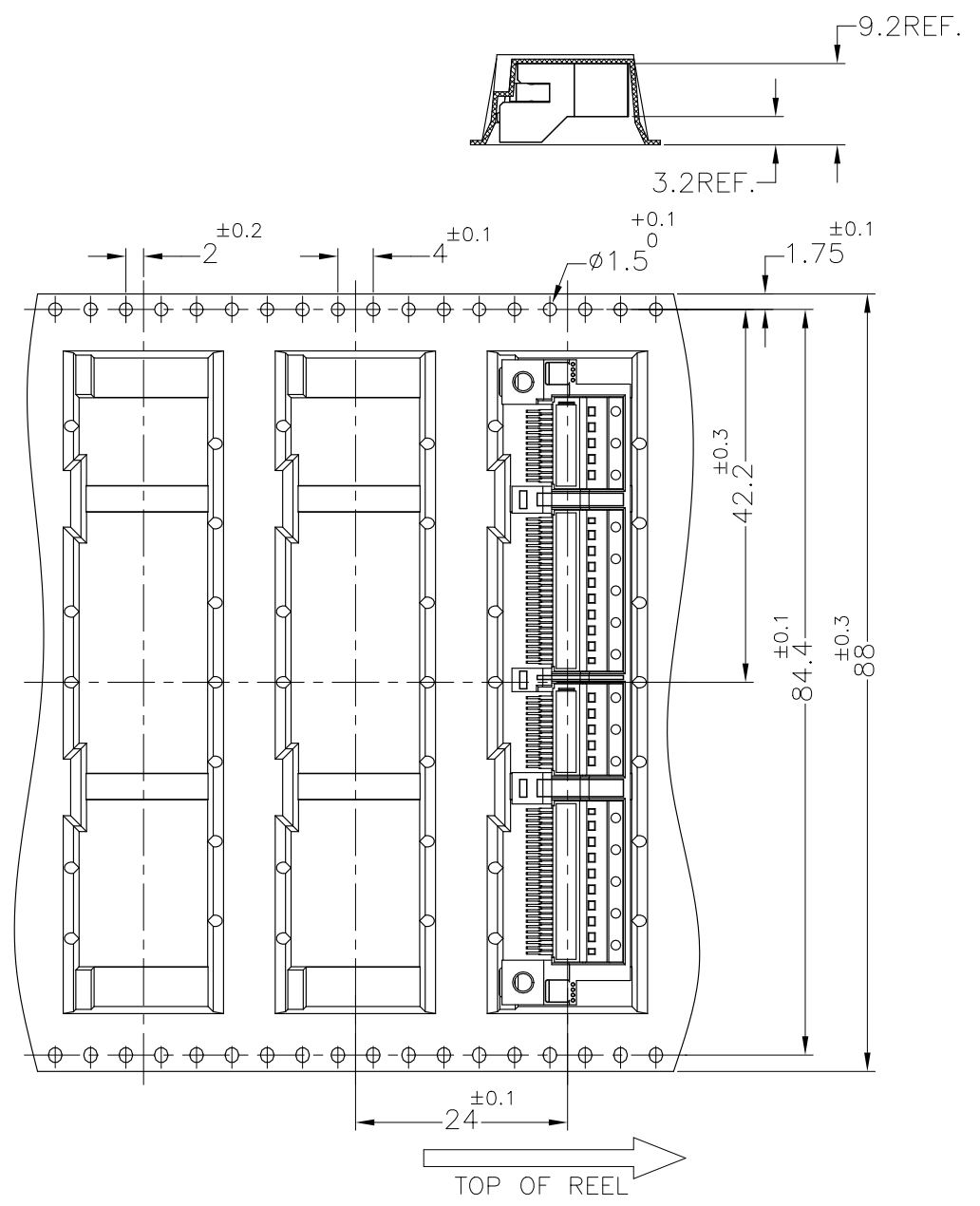
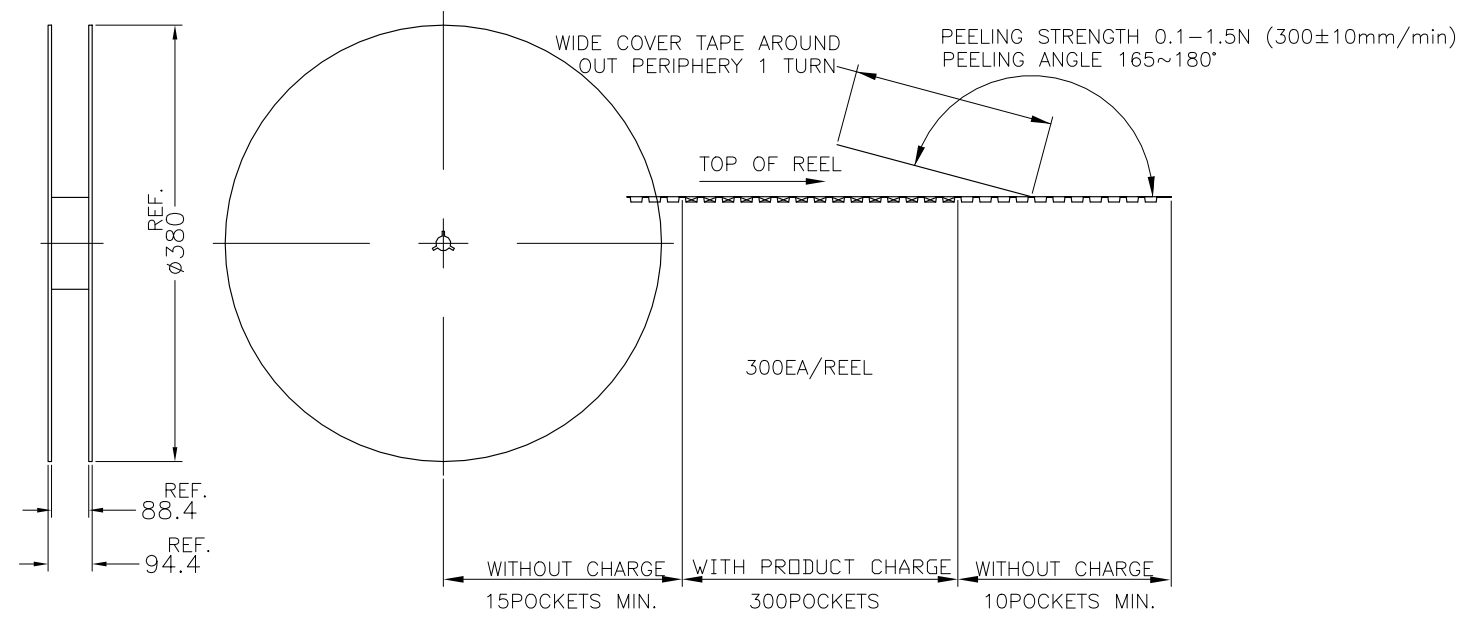

EMBOSS TAPE PACKAGING : 6--7, 6--9

THIS DRAWING IS A CONTROLLED DOCUMENT.		DWN	TE Connectivity Ltd.		
DIMENSIONS: mm		CHK	168 POSITION SLIVER 2.0 STRADDLE MOUNT		
TOLERANCES UNLESS OTHERWISE SPECIFIED:		APVD	NAME	SIZE	CAGE CODE
0-PLG	\pm	PRODUCT SPEC		A2	00779
1-PLG	\pm	APPLICATION SPEC		DRAWING NO. C=2340321	
2-PLG	\pm			SCALE	SHEET
3-PLG	\pm			NTS	6 of 6
4-PLG	\pm			REV	F
ANGLES	\pm	WEIGHT	CUSTOMER DRAWING		
FINISH					

X-ON Electronics

Largest Supplier of Electrical and Electronic Components

Click to view similar products for [Standard Card Edge Connectors](#) category:

Click to view products by [TE Connectivity](#) manufacturer:

Other Similar products are found below :

[CR7E-30DB-3.96E\(72\)](#) [6364499-1](#) [6565204-6](#) [PKC-156](#) [1437274-4](#) [147889-1](#) [1489165-4](#) [EBT15622B2X](#) [1-582587-1](#) [284-0102-12100](#)
[286-0052-12101A](#) [306022901000000](#) [307-012-502-202](#) [307-056-520-300](#) [2129318-1](#) [245-062-520-350](#) [287-0032-12101](#) [306-028-525-102](#)
[307-072-526-202](#) [345-060-559-303](#) [392-008-559-201](#) [534671-1](#) [341-240-317](#) [345-044-500-300](#) [346-240-318](#) [395-100-524-300](#) [09-07-2032](#)
[10035388-802LF](#) [10115859-011LF](#) [10122859-009LF](#) [10127905-B04B24BLF](#) [530555-1](#) [5-678046-1](#) [73726-0005](#) [66308-1](#) [1-1437275-6](#)
[PEC-07-02-T-S-A](#) [346-014-520-801](#) [307-048-502-202](#) [CE100F22-9-C](#) [CE100F26-7-C](#) [CE100F28-3-D](#) [CE156F18-9-C](#) [CE156F22-5-D](#)
[CE156F22-9-C](#) [CT100F22-2-D](#) [CT100F22-3-D](#) [CT100F24-2-D](#) [CT100F24-3-D](#) [CT100F24-6-C](#)