

PROPER USE GUIDELINES

Cumulative Trauma Disorders can result from the prolonged use of manually powered hand tools. Hand tools are intended for occasional use and low volume applications. A wide selection of powered application equipment for extended-use, production operations is available.

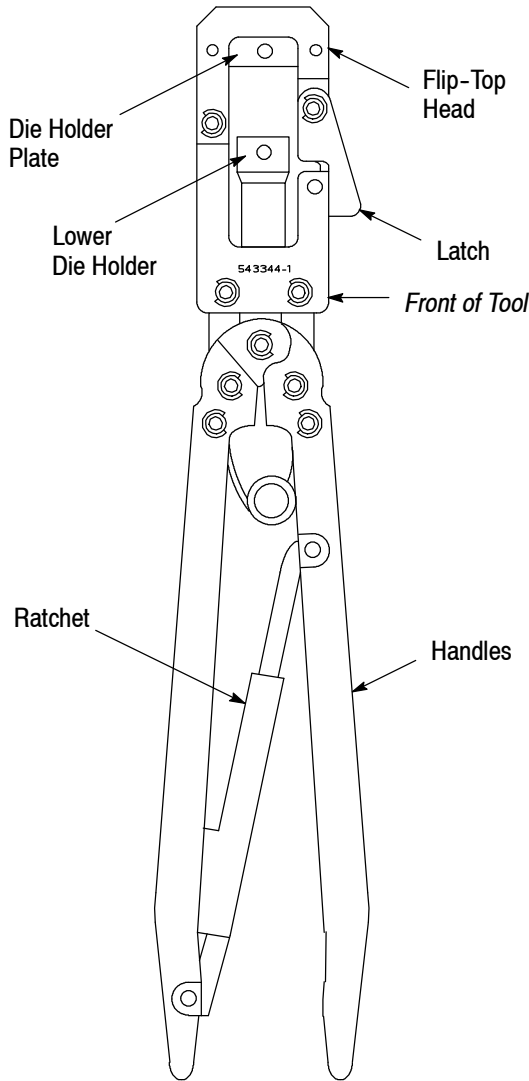



Figure 1

1. INTRODUCTION

Hand Crimping Tool Frame Assembly 543344-1 is designed to crimp the ferrule onto the shielding hardware or cable clamps used with AMPLIMITE HD-20 connectors. This tool accepts interchangeable dies which corresponds to the ferrule being crimped.

NOTE  Dimensions in this instruction sheet are in millimeters [with inches in brackets]. Figures and illustrations are for reference only and are not drawn to scale.

Reasons for reissue of this instruction sheet are provided in Section 7, REVISION SUMMARY.

2. DESCRIPTION (Figure 1)

The tool consists of a flip-top head with a latch, die holder plate, lower die holder, and handles with a ratchet. The flip-top head allows easy removal of the ferrule. The part number of the tool is on the front of the tool.

This tool is a member of the CERTI-CRIMP* hand crimping tool family. The ratchet on this tool ensures full crimping of the product. Once engaged, the ratchet will not release until the handles have been FULLY closed.

CAUTION  The dies bottom before the ratchet releases. This feature ensures maximum electrical and tensile performance of the crimp. DO NOT re-adjust the ratchet.

3. DIE INSERTION AND REMOVAL

3.1. Installation (Refer to Figure 2)

NOTE  Each set of dies consists of an anvil (moving die) and a crimper (stationary die). Most moving dies have square corners and the stationary dies have chamfered corners. Refer to Figure 2. Exceptions to this feature will be shown on the instruction sheet packaged with the dies.

1. Close the handles until the ratchet releases. Allow the handles to open FULLY.
2. Place the moving die in the lower die holder. Turn the die holding screw enough to hold die in place. DO NOT tighten the screw.
3. Place the stationary die in the die holder plate. Turn the die holding screw enough to hold the die in place. DO NOT tighten the screw.
4. Make sure that the dies and properly aligned, then close the handles, and tighten the die holding screws.

3.2. Removal

1. Close the handles until the ratchet releases. Allow the handles to open FULLY.
2. Loosen the die holding screws, and remove the dies.

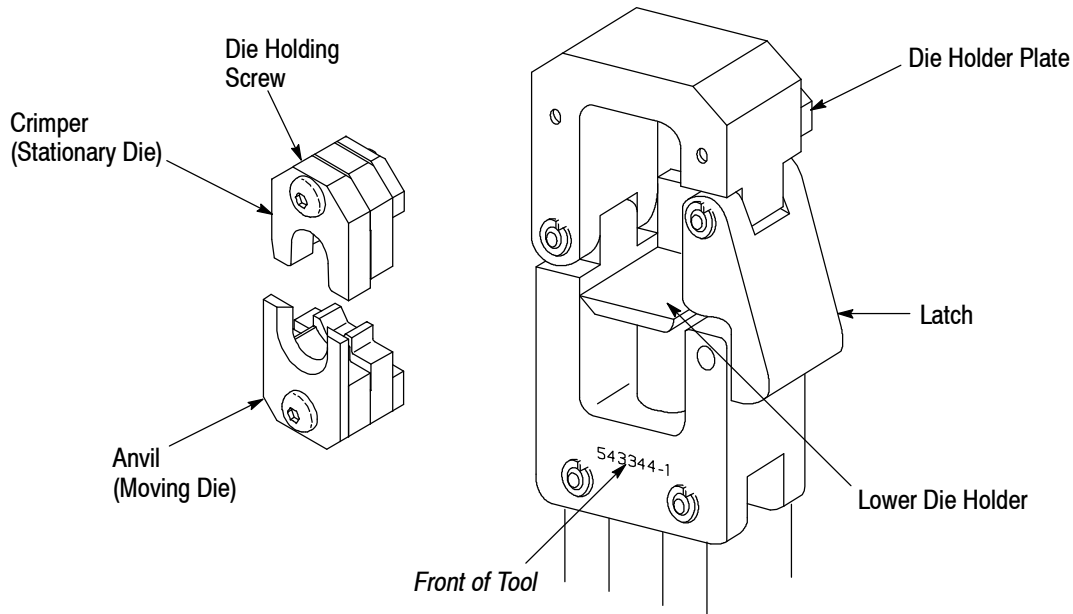
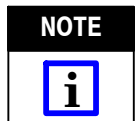

Figure 2

4. CRIMPING PROCEDURE

1. Close the handles until the ratchet releases. Allow the handles to open FULLY.
2. Open the latch, and looking into the front of the tool, insert the cable and ferrule into the back of the crimping chamber. Position the ferrule in the dies according to the instructions included with the dies. Close the latch.



Always refer to instruction sheet packaged with the dies for positioning of the ferrule in the dies.

3. Close the tool handles until the ferrule is held firmly in place.
4. Squeeze the tool handles together until the ratchet releases. Allow the handles to open FULLY, open the latch, and remove the crimped ferrule.

5. MAINTENANCE AND INSPECTION

It is recommended that a maintenance and inspection program be performed periodically to ensure dependable and uniform terminations. Though recommendations call for at least one inspection a month, frequency of inspection depends on:

1. The care, amount of use, and handling of the tool.
2. The presence of abnormal amounts of dust and dirt.
3. The degree of operator skill.
4. Your own established standards.

The tool is inspected before being shipped; however, it is recommended that the tool be inspected immediately upon arrival to ensure that the tool has not been damaged during shipment.

5.1. Daily Maintenance

1. Immerse the tool (handles partially closed) in a reliable commercial degreasing compound to remove accumulated dirt, grease, and foreign matter. When degreasing compound is not available, the tool may be wiped clean with a soft, lint-free cloth. DO NOT use hard or abrasive objects that could damage the tool.
2. Make certain that the retaining pins are in place and that they are secured with retaining rings.
3. All pins, pivot points, and bearing surfaces should be protected with a THIN coat of any good SAE 20 motor oil. DO NOT oil excessively.
4. When the tool is not in use, keep the handles closed to prevent objects from becoming lodged in the crimping dies. Store the tool in a clean, dry area.

5.2. Periodic Inspection

A. Lubrication

Lubricate all pins, pivot points, and bearing surfaces with any good SAE 20 motor oil as follows:

- Tool used in daily production — daily
- Tool used daily (occasional) — weekly
- Tool used weekly — monthly

Wipe excess oil from the tool, particularly from the crimping area. Oil transferred from the crimping area

onto certain terminations may affect the electrical characteristics of an application.

B. Visual Inspection

1. Close the tool handles until the ratchet releases and then allow them to open freely. If they do not open quickly and fully, the spring is defective and must be replaced. See Section 6, REPLACEMENT AND REPAIR.
2. Inspect the head for worn, cracked, or broken areas. If damage is evident, return the tool for evaluation and repair. See Section 6, REPLACEMENT AND REPAIR.
3. Check die alignment and tighten the die holding screws at least twice daily while tool is in use.

5.3. Ratchet Inspection

Check the ratchet to ensure that the ratchet does not release prematurely, allowing the dies to open before they have fully bottomed. Proceed as follows:

1. Remove traces of oil or dirt from the bottoming surfaces of the dies.
2. Obtain a 0.025 mm [.001 in.] shim that is suitable for checking the clearance between the bottoming surfaces of the dies.
3. Select a ferrule and *maximum* size cable for the ferrule.
4. Position the ferrule in the crimping chamber according to the instructions included with the crimping dies. Holding the cable in place, squeeze the tool handles together until the ratchet

releases. Hold the tool handles in this position, maintaining just enough pressure to keep the dies closed.

5. Check the clearance between the bottoming surfaces of the dies. If the clearance is 0.025 mm [.001 in.] or less, the ratchet is satisfactory. If clearance exceeds 0.025 mm [.001 in.], the ratchet is out of adjustment and must be repaired. See Section 6, REPLACEMENT AND REPAIR.

6. REPLACEMENT AND REPAIR

Customer-replaceable parts are listed in Figure 3. A complete inventory should be stocked and controlled to prevent lost time when replacement of parts is necessary. Parts other than those listed should be replaced by TE Connectivity to ensure quality and reliability. Order replacement parts through your TE Representative, or call 1-800-526-5142, or send a facsimile of your purchase order to 717-986-7605, or write to:

CUSTOMER SERVICE (038-035)
TYCO ELECTRONICS CORPORATION
PO BOX 3608
HARRISBURG PA 17105-3608

For customer repair service, call 1-800-526-5136.

7. REVISION SUMMARY

Revisions to this instruction sheet include:

- Updated document to corporate requirements
- New logo

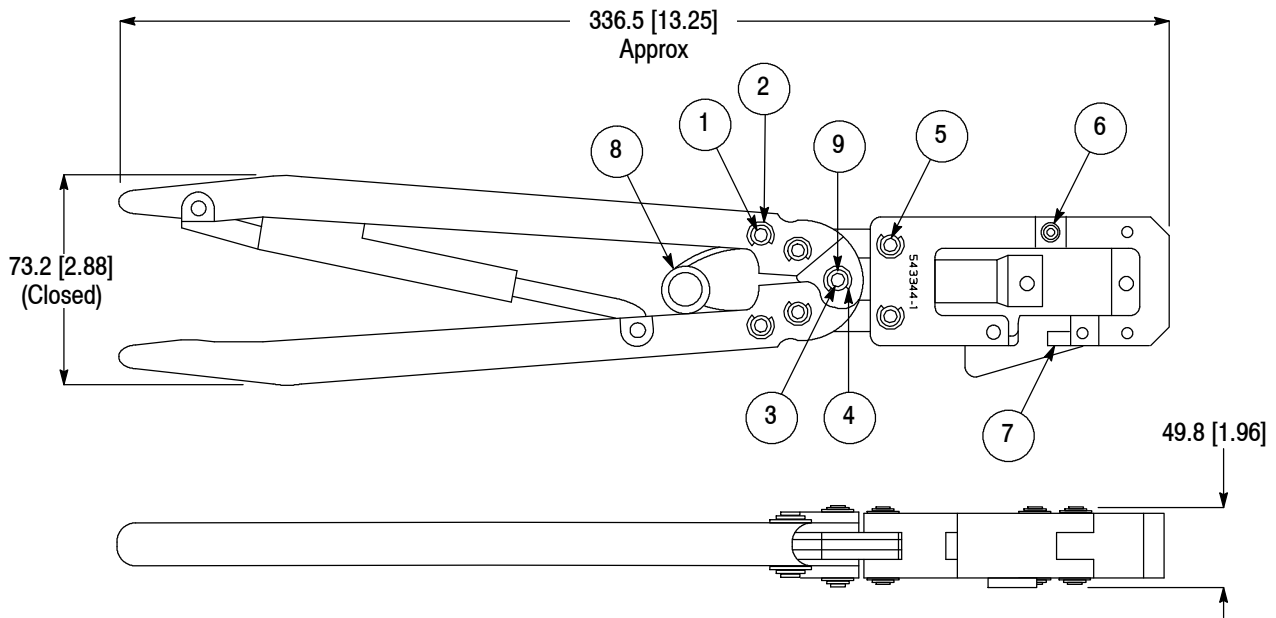

REPLACEMENT PARTS

ITEM	PART NUMBER	DESCRIPTION	QTY PER TOOL
1	300388	PIN, Retaining (Handles)	4
2	21045-3	RING, Retaining (Handles)	14
3	300389	PIN, Retaining (Center Pivot)	1
4	21045-6	RING, Retaining (Center Pivot)	2
5	305340	PIN, Retaining (Head)	3
6	543348-1	SPRING, Modified	1
7	1-22278-1	SPRING, Compression	1
8	1901139-1	SPRING, Torsion	1
9	125115-5	SPACER, Torsion Spring, .100 in. Thick	4

▪ Position spacers to keep torsion spring in center of handles.

Figure 3

X-ON Electronics

Largest Supplier of Electrical and Electronic Components

Click to view similar products for [Other Tools](#) category:

Click to view products by [TE Connectivity](#) manufacturer:

Other Similar products are found below :

[CR-0AFL4--332K](#) [568681-1](#) [5800-0090](#) [58061-1](#) [59065-5](#) [59085](#) [00-8273-RDPP](#) [00-8729-WHPP](#) [593033](#) [593072](#) [593564100](#) [593575](#)
[593593](#) [011349-000](#) [CRCW08052740FRT1](#) [LUC-012S070DSM](#) [LUC-018S070DSP](#) [LUC-024S105DSP](#) [599-2021-3-NME](#) [599-JJ-2021-03](#)
[00-5080-YWPP](#) [00-9089-RDPP](#) [00-9300-RDPP](#) [CRCW2010331JR02](#) [601-JJ-06](#) [601-SPB](#) [601YSY](#) [602-JJ-03](#) [602SPB](#) [603-JJ-07-FP](#) [603-](#)
[JJY-04](#) [M15570-25](#) [CRTN1013](#) [CS16](#) [6-1579014-0](#) [6203](#) [62200-5709](#) [6240-1](#) [M43435](#) [TY 2 SZ 3 FIN B BLK](#) [M-5Z](#) [M6816](#) [M7298](#)
[M7456](#) [M7976](#) [660-29ABT1](#) [662508-1](#) [CVHD-950X-93.333](#) [CW104-01X](#) [671-GP-04-KT39-73207](#) [CW307-01A](#)