

REV ISIONS		DATE	BY	APP'D
NO.	DESCRIPTION			
P	LTR			
A	FIRST VERSION			

NOTES :

- △ MATERIALS AND FINISH:
 - HOUSING: PA66
 - CONTACTS: COPPER ALLOY, FINISH: TIN OVER NICKEL UNDERPLATE

2. MUST COMPLY WITH DIRECTIVE 2002/95/EC (ROHS)
3. WIRE TYPES AND SIZES ACCEPTED
 WIRE RANGE: 16AWG~20AWG.
 STRIP LENGTH: 7.5mm~8.5mm
4. PACKAGED IN TRAY.
5. CURRENT RATING: 6Amp AC300V.
6. OPERATION TEMPERATURE: -40°C TO +105°C

P/N: *-2834019-*

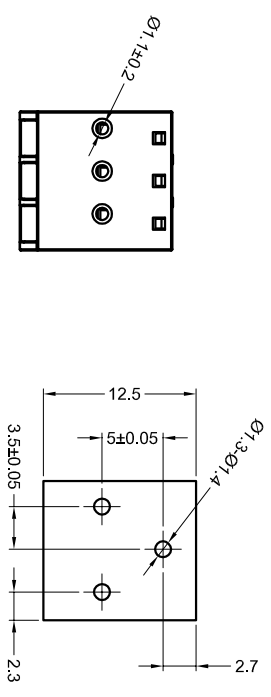

PCB Layout

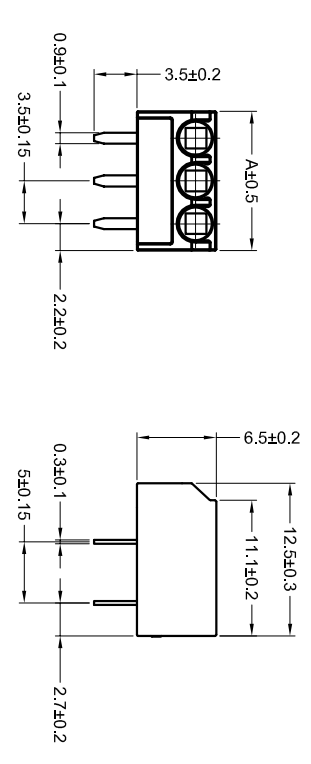

COLOR CODE:

SERIES CODE	POSN
1=GREEN	2=2 POSN
2=BLUE	3=3 POSN
3=BROWN	4=4 POSN
4=ORANGE	5=5 POSN
5=GREY	6=6 POSN
6=RED	7=7 POSN
7=YELLOW	8=8 POSN
8=PURPLE	
9=WHITE	
0=BLACK	

REMARK: THE DIFFERENT COLORS COULD BE COMBINED TO THE NEW CONNECTOR P/Ns FOR CUSTOMER REQUEST.

28.90	8 POSN
25.40	7 POSN
21.90	6 POSN
18.40	5 POSN
14.90	4 POSN
11.40	3 POSN
7.90	2 POSN
A	NO. OF POSITIONS

THIS DRAWING IS A CONTROLLED DOCUMENT.

DESIGNER	CHKD	DATE
SHI MING	SHI MING	14JAN2015
DRWING	CHKD	DATE
109-137083	109-137083	14-137083
VERSION		
A2		

3.50mm Pitch Modular Screwless Conn.

SCALE: 1:1

REV A



TE Connectivity

X-ON Electronics

Largest Supplier of Electrical and Electronic Components

Click to view similar products for [Fixed Terminal Blocks](#) category:

Click to view products by [TE Connectivity](#) manufacturer:

Other Similar products are found below :

[MBE-1512](#) [MBE-154](#) [MBE-156](#) [MBES-153](#) [MBES-156](#) [MH-2512](#) [MHE-132](#) [MHE-163](#) [MI-254 \(35\)](#) [MI-272](#) [880507](#) [MPT-275](#)
[15602-04-08-21](#) [BA311TU](#) [BA411SU](#) [MV-152](#) [MV-252-D](#) [MV-253/NCNOC](#) [MV-254-D](#) [MV-255](#) [MV-462](#) [MV-493](#) [MVE-252](#) [MVE-253](#)
[MVE-273](#) [MVEB-153](#) [1700096](#) [1705142](#) [1712417](#) [1713020](#) [1713088](#) [1745195](#) [1760594](#) [1776118-2](#) [1790852](#) [1-796689-8](#) [1-796692-6](#)
[1800001](#) [1800114](#) [1995279](#) [20020314-C121B01LF](#) [20020316-G041B01LF](#) [CB2-12](#) [KP03215000J0G](#) [KP04215000J0G](#) [S451](#) [282802-2](#)
[29.007](#) [29.116](#) [30.103](#)