

THIS DRAWING IS UNPUBLISHED. RELEASED FOR PUBLICATION
 © COPYRIGHT - By - ALL RIGHTS RESERVED.

REVISIONS				
P	LTR	DESCRIPTION	DATE	APVD
P1	ECR-16-004636		16-06-30	T.Q W.H

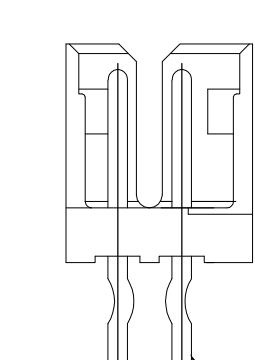
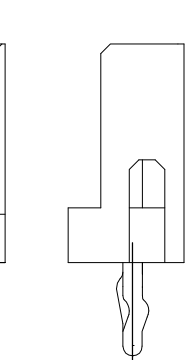
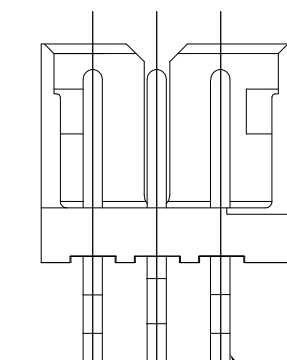
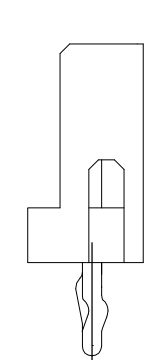
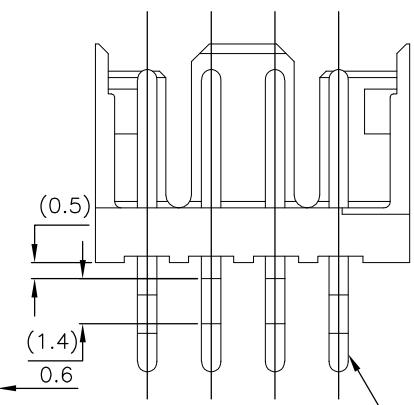
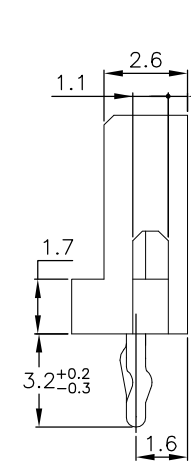
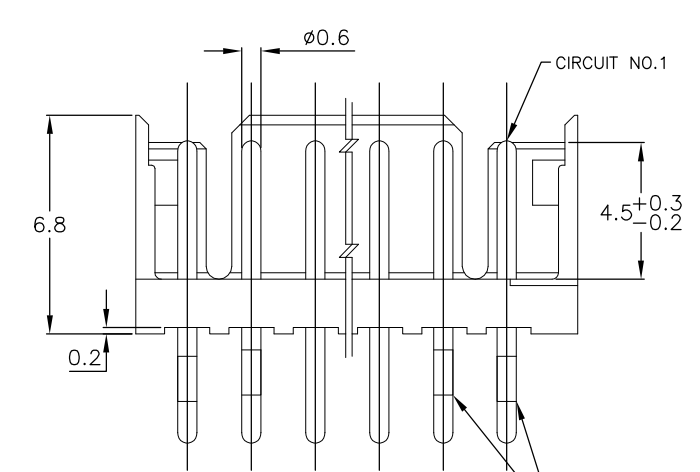
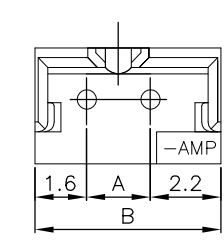
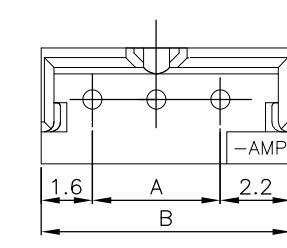
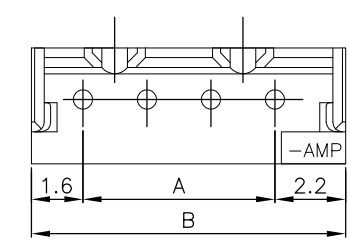
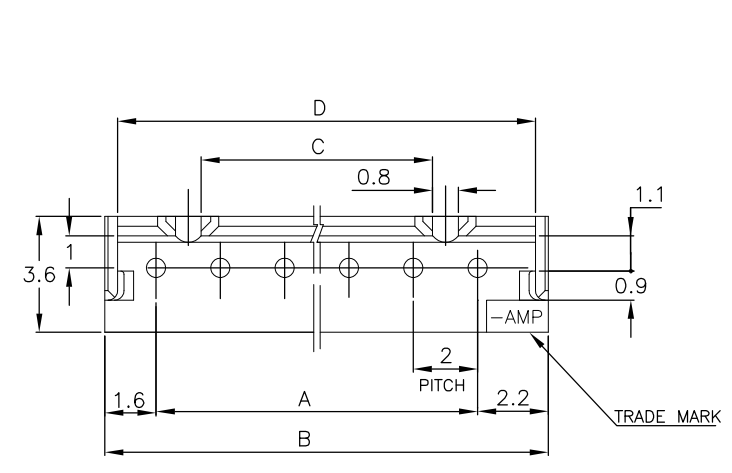

KINKING FORMING 4 PLACES

KINKING FORMING 3 PLACES

KINKING FORMING 2 PLACES

4 POS.

3 POS.

2 POS.

5~15 Pos.

KINKING FORMING 4 PLACES

NOTES:

- 1.MATERIAL: HOUSING - NYLON 66 (UL94V-0)
POST - TIN BRASS
- 2.APPLICABLE RECEPTACLE P/N 173977
- 3.OBSOLETE RED COLOR PARTS.

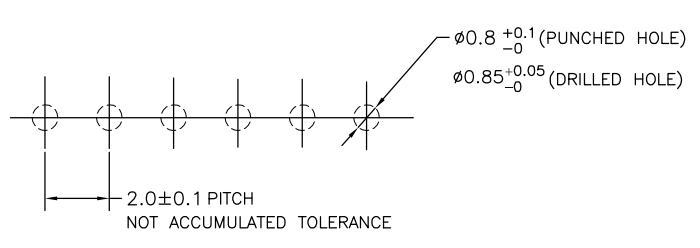

RECOMMENDABLE PCB LAYOUT
(PCB THK:0.8-1.6)

TOLERANCES UNLESS OTHERWISE SPECIFIED:	
10 ≥ *	: ±0.2
30 ≥ * > 10	: ±0.25
100 ≥ * > 30	: ±0.3
ANGLE	: ±3°

	7-292161-5	5-292161-5	3-292161-5	1-292161-5	15	28	31.8	25.2	31.0
	7- ↑ -4	5- ↑ -4	3- ↑ -4	1- ↑ -4	14	26	29.8	23.2	29.0
	7- -3	5- -3	3- -3	1- -3	13	24	27.8	21.2	27.0
9-292161-2	7- -2	5- -2	3- -2	1- -2	12	22	25.8	19.2	25.0
9- ↑ -1	7- -1	5- -1	3- -1	1- -1	11	20	23.8	17.2	23.0
9- = 0	7- -0	5- -0	3- -0	1- -0	10	18	21.8	15.2	21.0
8- -9	6- -9	4- -9	2- -9		9	16	19.8	13.2	19.0
8- -8	6- -8	4- -8	2- -8		8	14	17.8	11.2	17.0
8- -7	6- -7	4- -7	2- -7		7	12	15.8	9.2	15.0
8- -6	6- -6	4- -6	2- -6		6	10	13.8	7.2	13.0
8- -5	6- -5	4- -5	2- -5		5	8	11.8	5.2	11.0
8- -4	6- -4	4- -4	2- -4		4	6	9.8	3.2	9.0
8- ↓ -3	6- ↓ -3	4- ↓ -3	2- ↓ -3		3	4	7.8	-	7.0
8-292161-2	6-292161-2	4-292161-2	2-292161-2	292161-2	2	2	5.8	-	5.0
RED	BLACK	YELLOW	BLUE	NATURAL	Pos.	A	B	C	D

THIS DRAWING IS A CONTROLLED DOCUMENT.		DWN S.XU 31JAN03	STE TE Connectivity	
		CHK S.YAO 31JAN03		
		APVD T. SASAKI 31JAN03	NAME	
DIMENSIONS: mm		PRODUCT SPEC 108-60016	POST HEADER ASS'Y VERTICAL TYPE (AMP CT CONNECTOR 2mm PITCH)	
TOLERANCES UNLESS OTHERWISE SPECIFIED:		APPLICATION SPEC		
MATERIAL SEE NOTE		WEIGHT 0.000000	SIZE A3	CAGE CODE 00779
		FINISH SEE NOTE	DRAWING NO C-292161	RESTRICTED TO -
			SCALE 5:1	SHEET 1 OF 2
			CUSTOMER DRAWING	REV P1

THIS DRAWING IS UNPUBLISHED. RELEASED FOR PUBLICATION
 © COPYRIGHT - By - ALL RIGHTS RESERVED.

REVISIONS					
P	LTR	DESCRIPTION	DATE	DWN	APVD
-	-	SEE SHEET 1	-	-	-

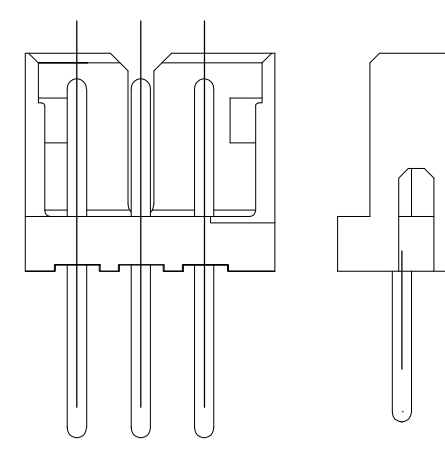
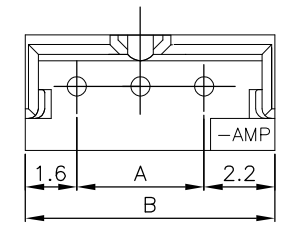
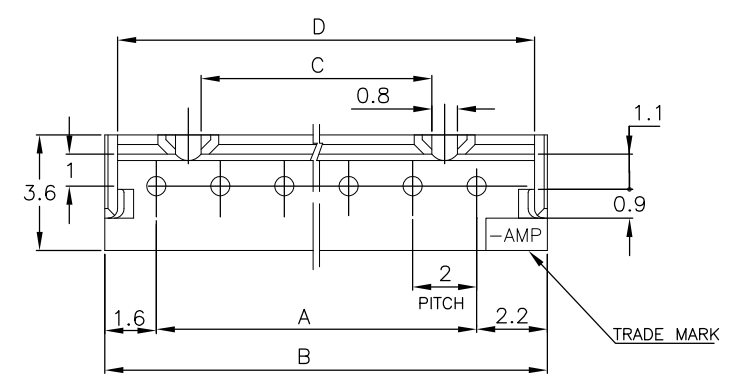

3 POS.

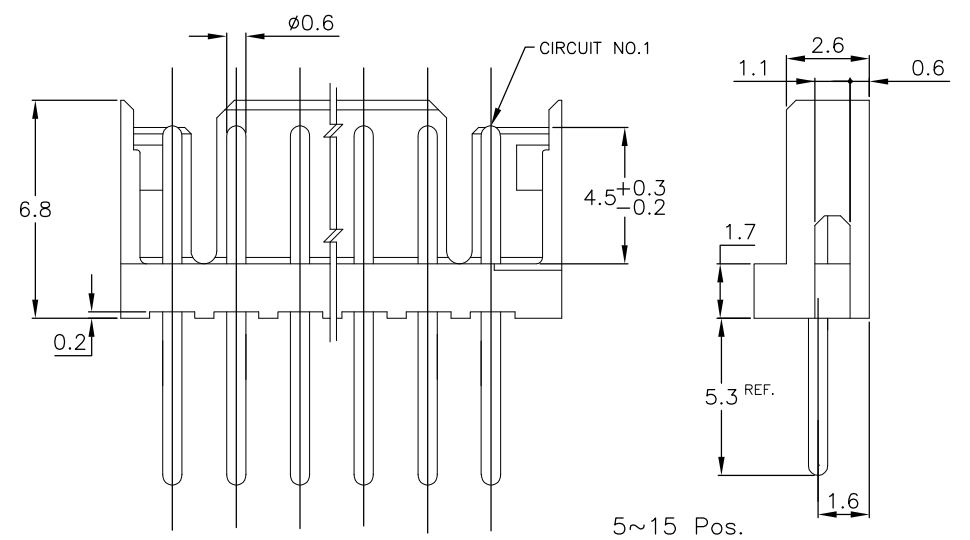

5~15 Pos.

NOTES:

- 1.MATERIAL: HOUSING - NYLON 66 (UL94V-0)
POST - TIN BRASS
- 2.APPLICABLE RECEPTACLE P/N 173977

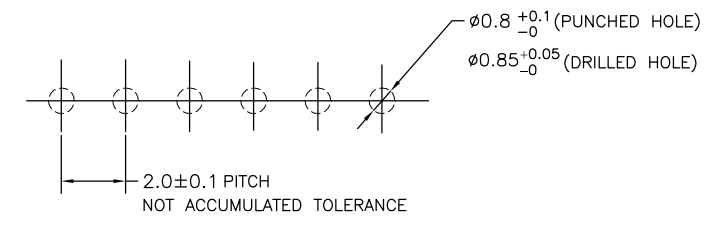

RECOMMENDABLE PCB LAYOUT
(PCB THK:0.8-1.6)

TOLERANCES UNLESS OTHERWISE SPECIFIED:	
10 ≥ *	: ±0.2
30 ≥ * > 10	: ±0.25
100 ≥ * > 30	: ±0.3
ANGLE	: ±3°

9-292161-7	7	12	15.8	9.2	15.0
9-292161-3	3	4	7.8	-	7.0
NATURAL	Pos.	A	B	C	D
PART NO.					

THIS DRAWING IS A CONTROLLED DOCUMENT.		DWN S.XU 31JAN03	TE Connectivity				
DIMENSIONS: mm		CHK S.YAO 31JAN03					
TOLERANCES UNLESS OTHERWISE SPECIFIED:		APVD T. SASAKI 31JAN03	NAME				
		PRODUCT SPEC 108-60016	POST HEADER ASS'Y VERTICAL TYPE (AMP CT CONNECTOR 2mm PITCH)				
MATERIAL SEE NOTE		FINISH SEE NOTE	APPLICATION SPEC -	SIZE A3	CAGE CODE 00779	DRAWING NO C-292161	RESTRICTED TO -
		WEIGHT 0.000000	SCALE 5:1		SHEET 2 OF 2	REV P1	
		CUSTOMER DRAWING					

X-ON Electronics

Largest Supplier of Electrical and Electronic Components

Click to view similar products for [Headers & Wire Housings](#) category:

Click to view products by [TE Connectivity](#) manufacturer:

Other Similar products are found below :

[892-18-020-10-001101](#) [58102-G61-06LF](#) [582553-1](#) [0009485154](#) [009176003701906](#) [0050291907](#) [LY20-4P-DT1-P1E-BR](#) [02.125.8002.8](#)
[609-3404](#) [61062-3](#) [61082-181009](#) [622-3653LF](#) [63453-116](#) [636-1030](#) [636-1427](#) [636-3427](#) [636-4007](#) [641938-9](#) [641991-4](#) [644827-2](#) [65817-010LF](#) [65817-015LF](#) [65863-015LF](#) [66207-023LF](#) [67095-007LF](#) [67601157](#) [68645-018](#) [68648-049](#) [70.362.1628.0](#) [70-4210](#) [70-4226B](#) [70-4853B](#) [707-5020](#) [707-5028](#) [71.350.2428.0](#) [71918-208LF](#) [71961-016LF](#) [733-134](#) [733-162](#) [754199-000](#) [760-3052](#) [787-8014-00](#) [79531-3000](#)
[FCN-360C032-B](#) [FCN-367T-T012/H](#) [FCN-723D010/2](#) [80.063.4001.1](#) [800-90-001-10-001000](#) [800-90-010-10-002000](#) [801-43-002-10-013000](#)