

THIS DRAWING IS UNPUBLISHED. RELEASED FOR PUBLICATION.
 © COPYRIGHT 20 BY TYCO ELECTRONICS CORPORATION. ALL RIGHTS RESERVED.

LOC	DIST	REVISIONS					
FB	00	P	LTR	DESCRIPTION	DATE	DWN	APVD
				P2 ECR-18-012951	27SEP18	T.Q	W.H

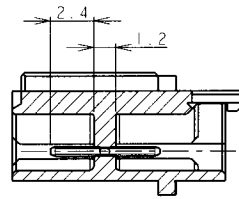

SECT A-A

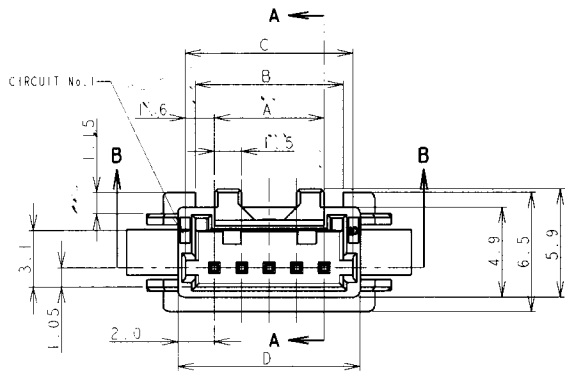
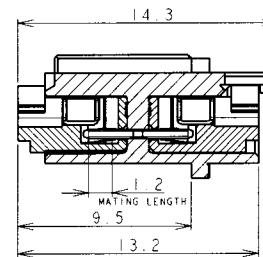

MATING SECTION

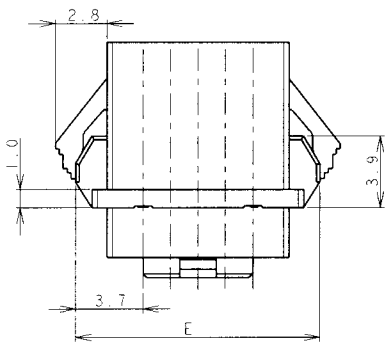
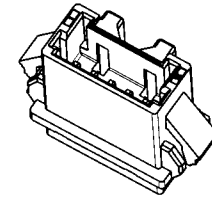

RECOMMENDED FIRST MATING SIDE

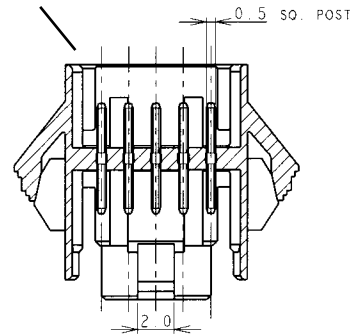

SECT B-B

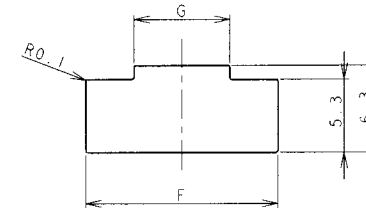

PANEL CUTOUT DIMENSION (TOLERANCE: ±0.1mm)
 (RECOMMENDED PANEL THICKNESS: 0.8mm~1.6mm)

- NOTES
- MATERIAL
 HOUSING: 66NYLON(94V-0), COLOR: WHITE, BLUE
 POST: TIN BRASS WIRE
 - THE PANEL SHOULD BE PUNCHED SO THAT THE HOUSING ENTERS THE PANEL IN THE SAME DIRECTION AS PUNCH.

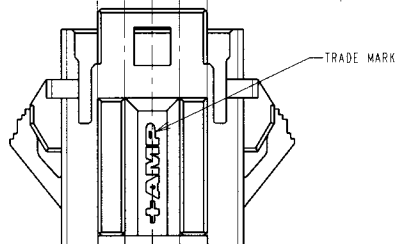
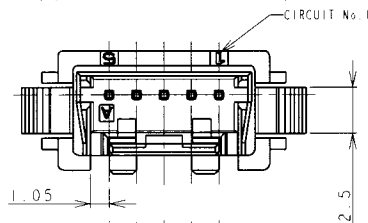

THIS DRAWING IS A CONTROLLED DOCUMENT FOR TYCO ELECTRONICS CORPORATION. IT IS SUBJECT TO CHANGE AND THE CONTROLLING ENGINEERING ORGANIZATION SHOULD BE CONTACTED FOR THE LATEST REVISION.		DWN	J. JIANG	04FEB03	 Tyco Electronics Corporation Shanghai, P.R.China, 200233
DIMENSIONS (mm)		CHK	S. YAO	04FEB03	
TOLERANCES UNLESS OTHERWISE SPECIFIED: 10 ± .02 30 ± .03 100 ± .05 ANGLE ± 3°		APVD	T. SASAKI	04FEB03	
MATERIAL		PRODUCT SPEC		NAME	
SEE NOTE 1		108-60018		AMP MINI COMMON TERMINATED (CT) CONNECTOR 1.5mm PITCH SINGLE ROW POST HEADER ASS'Y PANEL MOUNT TYPE	
FINISH		APPLICATION SPEC		RESTRICTED TO	
SEE NOTE 1		114-5223		-	
WEIGHT		CUSTOMER DRAWING		SCALE	
				NON	
				SHEET 1 OF 2	
				REV P2	

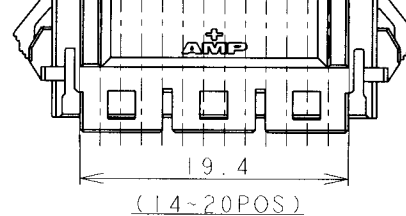
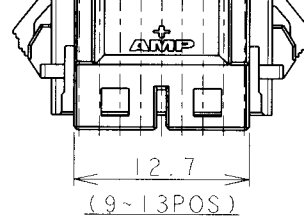
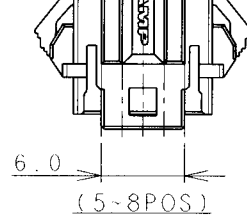

1.41	19.8	36.5	35.9	32.5	31.7	30.6	28.5	20	7-292215-0	4-292215-0	2-292215-0
1.35	19.8	35.0	34.4	31.0	30.2	29.1	27.0	19	6-292215-9	3-292215-9	1-292215-9
1.30	19.8	33.5	32.9	29.5	28.7	27.6	25.5	18	6-292215-8	3-292215-8	1-292215-8
1.24	19.8	32.0	31.4	28.0	27.2	26.1	24.0	17	6-292215-7	3-292215-7	1-292215-7
1.19	19.8	30.5	29.9	26.5	25.7	24.6	22.5	16	6-292215-6	3-292215-6	1-292215-6
1.13	19.8	29.0	28.4	25.0	24.2	23.1	21.0	15	6-292215-5	3-292215-5	1-292215-5
1.08	19.8	27.5	26.9	23.5	22.7	21.6	19.5	14	6-292215-4	3-292215-4	1-292215-4
0.97	13.1	26.0	25.4	22.0	21.2	20.1	18.0	13	6-292215-3	3-292215-3	1-292215-3
0.92	13.1	24.5	23.9	20.5	19.7	18.6	16.5	12	6-292215-2	3-292215-2	1-292215-2
0.86	13.1	23.0	22.4	19.0	18.2	17.1	15.0	11	6-292215-1	3-292215-1	1-292215-1
0.81	13.1	21.5	20.9	17.5	16.7	15.6	13.5	10	6-292215-0	3-292215-0	1-292215-0
0.75	13.1	20.0	19.4	16.0	15.2	14.1	12.0	9	5-292215-9	2-292215-9	0-292215-9
0.64	6.4	18.5	17.9	14.5	13.7	12.6	10.5	8	5-292215-8	2-292215-8	0-292215-8
0.59	6.4	17.0	16.4	13.0	12.2	11.1	9.0	7	5-292215-7	2-292215-7	0-292215-7
0.53	6.4	15.5	14.9	11.5	10.7	9.6	7.5	6	5-292215-6	2-292215-6	0-292215-6
0.48	6.4	14.0	13.4	10.0	9.2	8.1	6.0	5	5-292215-5	2-292215-5	0-292215-5
0.44	4.9	12.5	11.9	8.5	7.7	6.6	4.5	4	5-292215-4	2-292215-4	0-292215-4
0.37	4.1	11.0	10.4	7.0	6.2	5.1	3.0	3	5-292215-3	2-292215-3	0-292215-3
0.30	2.6	9.5	8.9	5.5	4.7	3.6	1.5	2	5-292215-2	2-292215-2	0-292215-2
WEIGHT (g)	G	F	E	D	C	B	A		BLUE	BLACK	WHITE
	DIMENSIONS							Pos	P/N		

DIMENSIONS: mm	DWN	MATERIAL	SEE SHEET 1	FINISH	SEE SHEET 1
	CHK	Tyco Electronics Corporation Shanghai, P.R.China, 200233			
TOLERANCES UNLESS OTHERWISE SPECIFIED: 10 > : ±0.2 30 > 10 : ±0.25 100 > 30 : ±0.3 ANGLE : ±3°	APVD				
	PRODUCT SPEC	NAME AMP MINI COMMON TERMINATED (CT) CONNECTOR 1.5mm PITCH SINGLE ROW POST HDR ASS'Y PANEL MOUNT TYPE			
	APPLICATION SPEC	SIZE	CAGE CODE	DRAWING NO	RESTRICTED TO
WEIGHT	A4 00779 C-292215				
CUSTOMER DRAWING	SCALE	NON	SHEET	2 OF 2	REV P2

X-ON Electronics

Largest Supplier of Electrical and Electronic Components

Click to view similar products for [Headers & Wire Housings](#) category:

Click to view products by [TE Connectivity](#) manufacturer:

Other Similar products are found below :

[892-18-020-10-001101](#) [58102-G61-06LF](#) [582553-1](#) [0009485154](#) [009176003701906](#) [0050291907](#) [LY20-4P-DT1-P1E-BR](#) [02.125.8002.8](#)
[609-3404](#) [61062-3](#) [61082-181009](#) [622-3653LF](#) [63453-116](#) [636-1030](#) [636-1427](#) [636-3427](#) [636-4007](#) [641938-9](#) [641991-4](#) [644827-2](#) [65817-](#)
[010LF](#) [65817-015LF](#) [65863-015LF](#) [66207-023LF](#) [67095-007LF](#) [67601157](#) [68645-018](#) [68648-049](#) [70.362.1628.0](#) [70-4210](#) [70-4226B](#) [70-](#)
[4853B](#) [707-5020](#) [707-5028](#) [71.350.2428.0](#) [71918-208LF](#) [71961-016LF](#) [733-134](#) [733-162](#) [754199-000](#) [760-3052](#) [787-8014-00](#) [79531-3000](#)
[FCN-360C032-B](#) [FCN-367T-T012/H](#) [FCN-723D010/2](#) [80.063.4001.1](#) [800-90-001-10-001000](#) [800-90-010-10-002000](#) [801-43-002-10-013000](#)