

P	LTR	DESCRIPTION	DATE	DWN	APVD
	D	REVISED	25APR11	MM	NY

1318126-1/-2/-3 : AS SHOWN
9-1318126-2

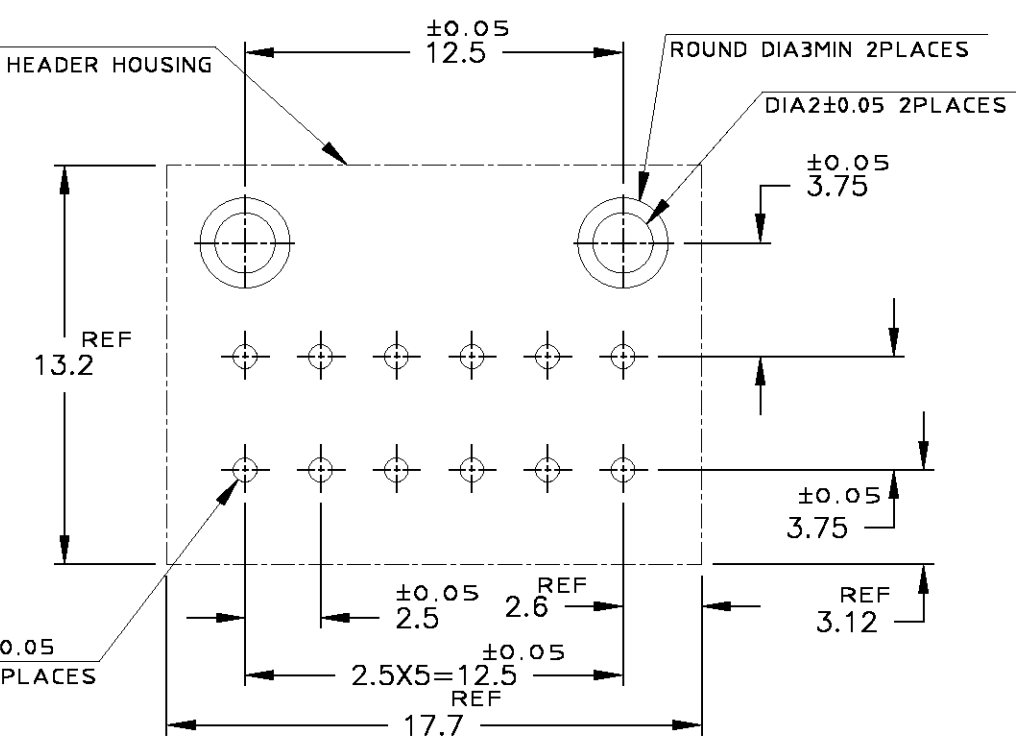

RECOMENDED PC BOARD HOLE PATTERN(TOL:±0.05)
PC BOARD THICKNESS:1.6±0.3
(CONNECTOR MOUNT SIDE)

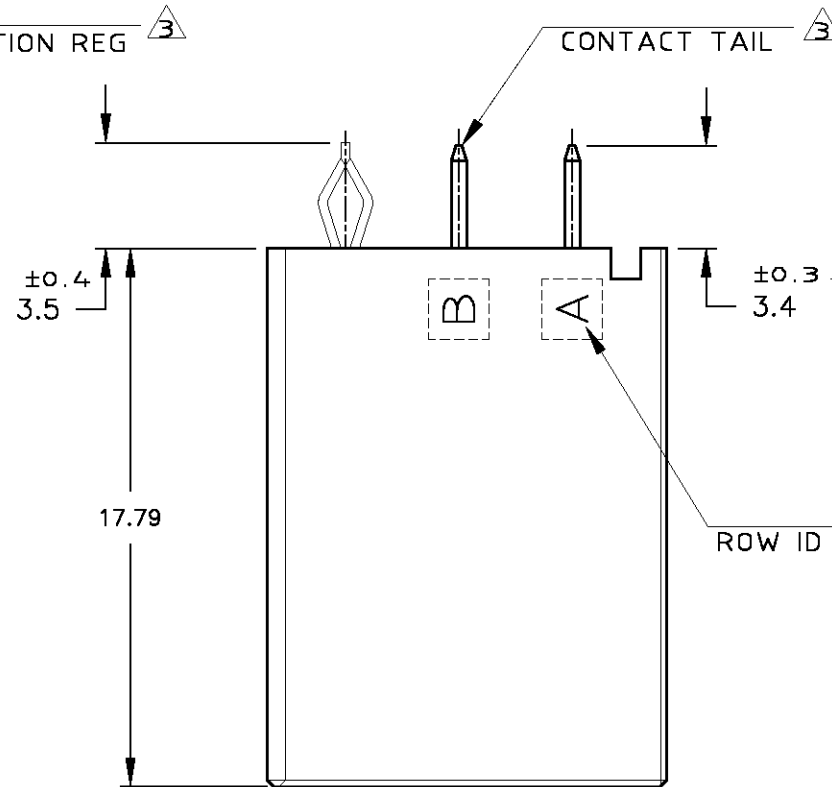
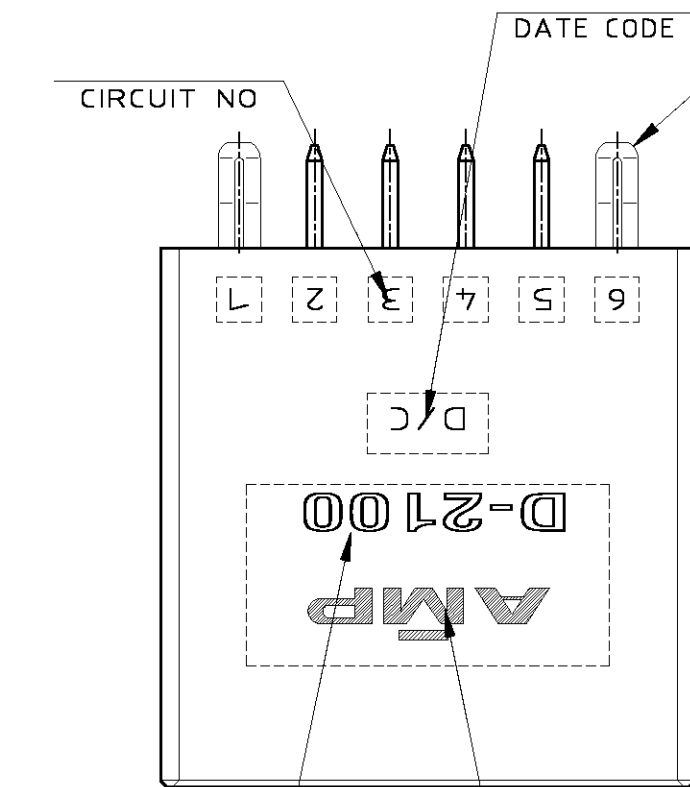
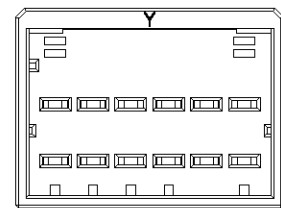

9-1318126-2
1318126-2
(KEYING Y)
SCALE:2-1

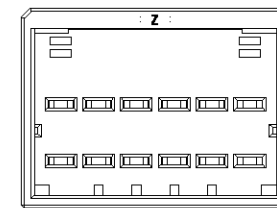

1318126-3
(KEYING Z)
SCALE:2-1

NOTES

- MATERIAL:HOUSING:GLASS FILED THERMO PLASTIC ,POLYESTER(94V-0),
COLOR: 1318126-1/-2/-3 : BLACK
9-1318126-2 : NATURAL
TAB CONTACT:COPPER ALLOY
RETENTION LEG:BRASS
- FINISH(CONTACT AREA):0.38µmMIN GOLD PLATING
OVER NI PLATING
- FINISH(RETENTION LEG): TIN PLATED
(CONTACT TAIL) OVER NICKEL

KEY	COLOR	TYPE	PART NO
Y	BLACK	SEQUENTIAL SHEET2	1-1318126-2
X	BLACK	SEQUENTIAL SHEET2	1-1318126-1
Z	BLACK	NORMAL	1318126-3
Y	NATURAL	NORMAL	9-1318126-2
Y	BLACK	NORMAL	1318126-2
X	BLACK	NORMAL	1318126-1

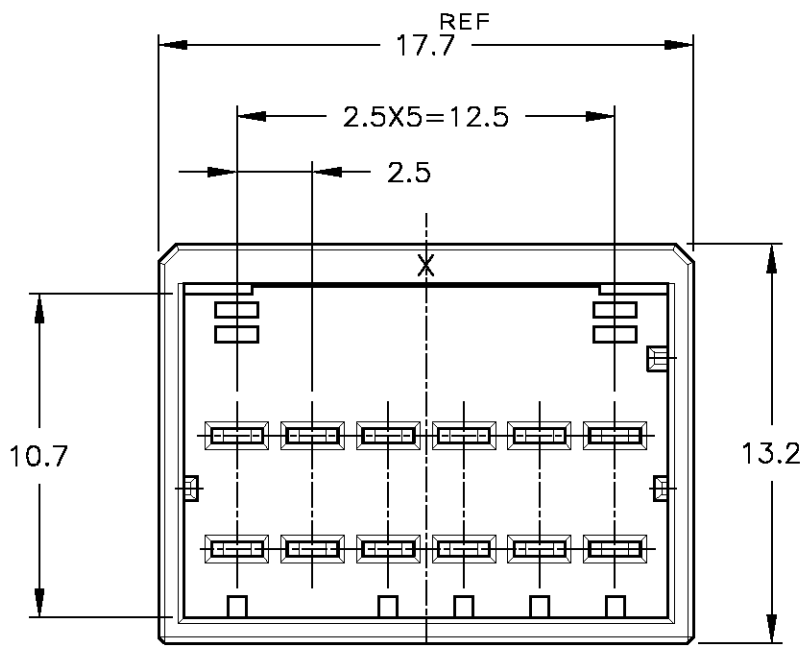

1318126-1
(KEYING X)

DWN K.IKEDA 7/DEC/'98		TE Connectivity	
CHK N.MATSUBARA 7/DEC/'98			
APVD I.HASEGAWA 7/DEC/'98		NAME	
PRODUCT SPEC		DOUBLE ROW HEADER ASS'Y 12P ("V"TYPE) <DYNAMIC D-2100D>	
APPLICATION SPEC		SIZE A3	CAGE CODE 00779
WEIGHT		DRAWING NO C-1318126	
MATERIAL SEE NOTES		RESTRICTED TO -	
FINISH SEE NOTES		SCALE 4-1 SHEET 1 OF 2 REV D	
CUSTOMER DRAWING			

LOC	DIST
J	

REVISIONS					
P	LTR	DESCRIPTION	ECN	DATE	APVD
		SEE SHEET 1			

1-1318126-1,2;AS SHOWN SEQUENTIAL TYPE

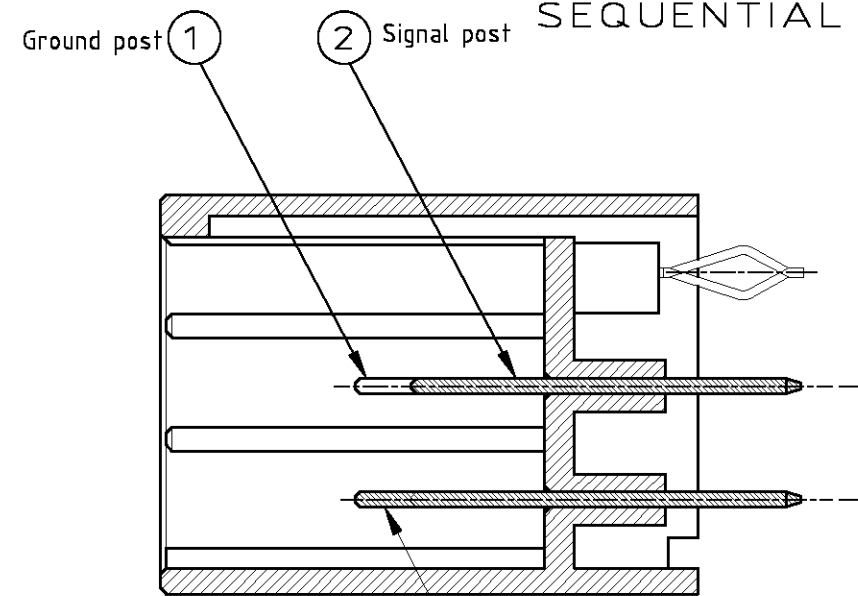
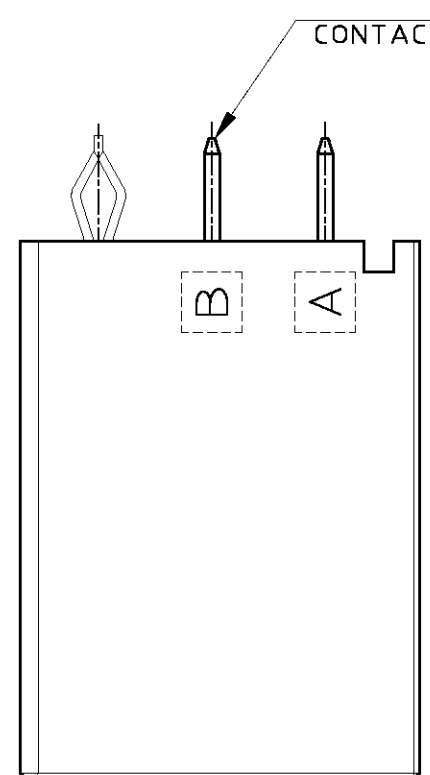
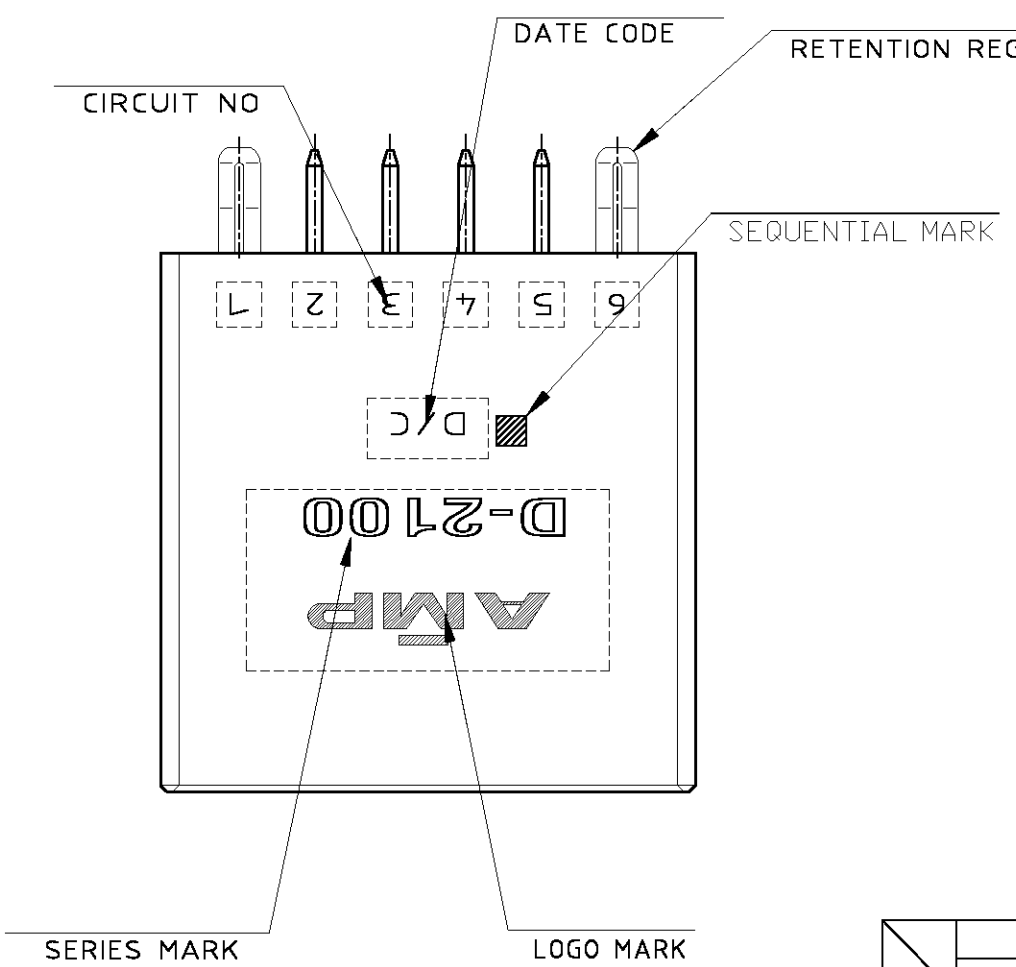

Ground post 1
Signal post 2
SECT A-A

		CIRCUIT NO					
		1	2	3	4	5	6
ROW	B	①	②	②	②	②	②
	A	②	②	②	②	②	①

POINT OF SEQUENTIAL
1-1318126-1,2

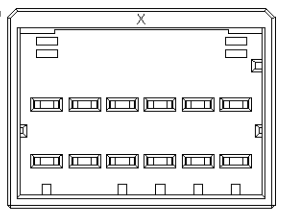
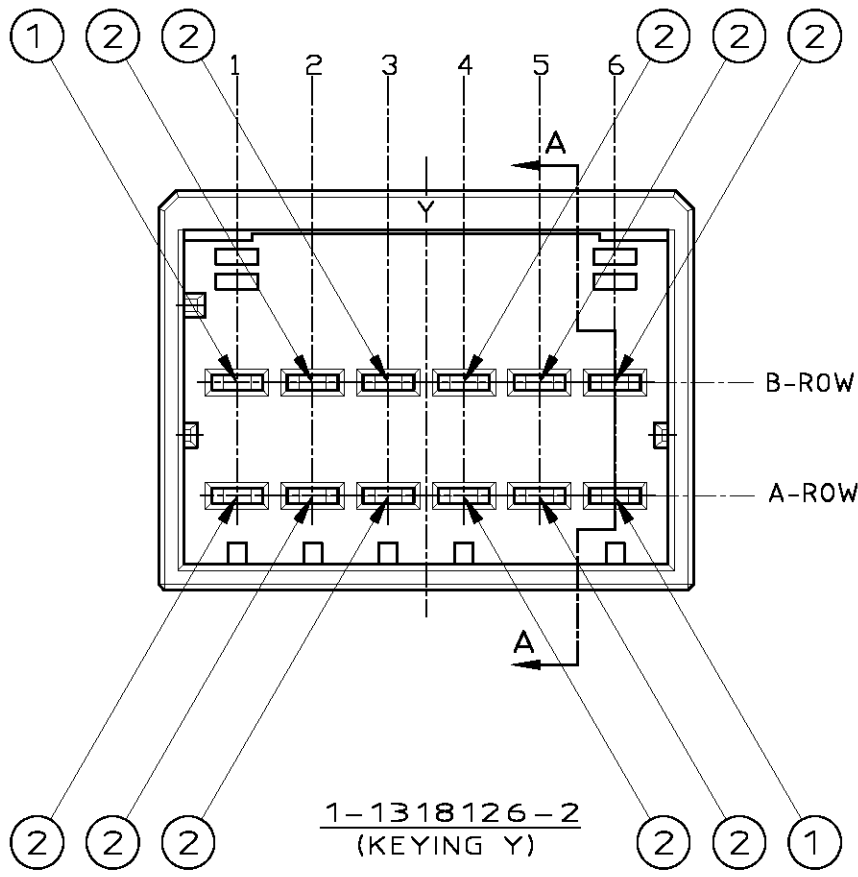

1-1318126-1
(KEYING X)
SCALE:2-1

NOTES

- 1. MATERIAL:HOUSING:GLASS FILED THERMO PLASTIC ,POLYESTER(94V-0),COLOR:BLACK
- TAB CONTACT:COPPER ALLOY
- RETENTION LEG:BRASS
- 2. FINISH(CONTACT AREA):0.38μmMIN GOLD PLATING OVER Ni PLATING
- 3. FINISH(RETENTION LEG): TIN PLATED (CONTACT TAIL) OVER NICKEL

DIMENSIONS: mm		TOLERANCES UNLESS OTHERWISE SPECIFIED		DWN K.IKEDA 7/DEC/98 CHK N.MATSUBARA 7/DEC/98 APVD I.HASEGAWA 7/DEC/98		TE Connectivity	
		100 ±0.3 300 >10 ±0.35 1000 >30 ±0.4 ANGLE: ±3°		PRODUCT SPEC 108-5619		NAME DOUBLE ROW HEADER ASS'Y 12P ("V"TYPE) <DYNAMIC D-2100D>	
MATERIAL SEE NOTES		FINISH SEE NOTES		APPLICATION SPEC 114-5258		DRAWING NO C-1318126	
				WEIGHT T1		RESTRICTED TO -	
CUSTOMER DRAWING				SCALE 4-1		SHEET 2 OF 2 REV D	

X-ON Electronics

Largest Supplier of Electrical and Electronic Components

Click to view similar products for [Headers & Wire Housings](#) category:

Click to view products by [TE Connectivity](#) manufacturer:

Other Similar products are found below :

[892-18-020-10-001101](#) [58102-G61-06LF](#) [582553-1](#) [0009485154](#) [009176003701906](#) [0050291907](#) [LY20-4P-DT1-P1E-BR](#) [02.125.8002.8](#)
[609-3404](#) [61062-3](#) [61082-181009](#) [622-3653LF](#) [63453-116](#) [636-1030](#) [636-1427](#) [636-3427](#) [636-4007](#) [641938-9](#) [641991-4](#) [644827-2](#) [65817-010LF](#) [65817-015LF](#) [65863-015LF](#) [66207-023LF](#) [67095-007LF](#) [67601157](#) [68645-018](#) [68648-049](#) [70.362.1628.0](#) [70-4210](#) [70-4226B](#) [70-4853B](#) [707-5020](#) [707-5028](#) [71.350.2428.0](#) [71918-208LF](#) [71961-016LF](#) [733-134](#) [733-162](#) [754199-000](#) [760-3052](#) [787-8014-00](#) [79531-3000](#)
[FCN-360C032-B](#) [FCN-367T-T012/H](#) [FCN-723D010/2](#) [80.063.4001.1](#) [800-90-001-10-001000](#) [800-90-010-10-002000](#) [801-43-002-10-013000](#)