



Tyco Electronics - Schrack has a reputation for sound technical experience and provides engineering and sales support in local markets which in turn leads to total customer satisfaction.

World-wide we build lasting relationships with our customers through the innovative combination of:

- high quality products
- individual application support and
- complete service.

As a specialist and innovator for relays we offer technically superior and environmentally friendly solutions for reliable electrical switching.

Our extensive knowledge of markets and technology ensure that our products and systems provide optimal solutions for our customers and their applications.

Contents

Relay Range	page	4
-------------	------	---

PCB & Power Relays

PE	Miniature PCB Relay PE	page	22
PE	Miniature PCB Relay PE bistable	page	24
RE	Miniature PCB Relay RE	page	26
PCN	Slim PCB Relay PCN	page	28
V23092	Slim PCB Relay SNR	page	30
RYII	Miniature Power PCB Relay RY II	page	33
V23061	Miniature Power PCB Relay MSR	page	36
RT1	Power PCB Relay RT1 DC and AC	page	39
RT1	Power PCB Relay RT1 bistable	page	42
RT1	Power PCB Relay RT1 sensitive	page	44
RT1	Power PCB Relay RT1 Inrush	page	46
429 03	Power PCB Relay 429 03 Inrush	page	48
RTH	Power PCB Relay RTH 105°C sensitive	page	50
RTH	Power PCB Relay RTH 105°C 16 A	page	52
RP11/1	Power PCB Relay RP II/1	page	54
RP3SL	Special Load PCB Relay RP 3 SL	page	57
409 47, 409 67	Special Load PCB Relay 409 47, 409 67	page	60
V23077	Faston Power Relay IF 125°C	page	63
410 63	Faston Power Relay 410 63, 125°C	page	65
410 83	Faston Power Relay 410 83, 3 mm	page	67
RT2	Power PCB Relay RT2 DC and AC	page	69
RT2	Power PCB Relay RT2 bistable	page	72
RP11/2	Power PCB Relay RP II/2	page	74
V23057	Power PCB Relay Card E	page	76
V23148	Power PCB Relay U/UB	page	79
PCD	Low Profile PCB Relay PCD	page	82
PB	Miniature Power PCB Relay PB	page	84
PBH	Miniature Power PCB Relay PBH 105°C	page	86
T7N/T7N-WG	Miniature Power PCB Relay T7N / T7N-WG	page	88
T9A	Power Relay T9A	page	91
T92	Power Relay T92	page	94
430	Power Relay 430 3 mm	page	97
430	Power Relay 430 1- and 2-pole	page	100
419 01	Rast 5 Power Relay 419 01	page	103

Safety Relays

V23047	Safety Relay SR2M	page	106
SR4 D/M	Safety Relay SR4 D/M	page	109
SR6 D/M	Safety Relay SR6 D/M	page	112
V23050	Safety Relay SR6	page	114
SR6	Safety Relay SR6 sensitive	page	117
SR6Z	Safety Relay Module SR6	page	120

Contents

Industrial Relays

ST	..Slim Interface Relay SNR	page 122
RT	..Interface Power Relay RT	page 124
PT	..Miniature Relay PT	page 127
TM	..Miniature Power Relay PCLH	page 131
MT	..Multimode Relay MT	page 133
RM2/3/7	..Power Relay RM2/3/7	page 136
RM5/6	..Power Relay RM5/6	page 140
RM8	..Power Relay RM8	page 144
RMC/RMD	..Power Relay RMC/RMD	page 147

Accessories

V23092	..Accessories - Slim Interface Relay SNR	page 151
RYII	..Accessories - Miniature PCB Relay RY II	page 152
V23057	..Accessories - Card Relay E	page 153
RT1	..Accessories - Power PCB Relay RT1	page 154
RP1I/1	..Accessories - PCB Relay RP II/1	page 154
RT2	..Accessories - Power PCB Relay RT2	page 154
RP1I/2	..Accessories - PCB Relay RP II/2	page 154
V23047	..Accessories - Safety Relay SR2M	page 154
PT	..Accessories - Miniature Relay PT	page 158
MT	..Accessories - Multimode Relay MT	page 162
PCLH	..Accessories - Miniature Power Relay PCLH	page 165
RM2/3/7	..Accessories - Power Relay RM2/3/7	page 166
RM5/6	..Accessories - Power Relay RM5/6	page 166

Packages

ST	..Relay Package SNR	page 168
RT	..Relay Package RT	page 169
PT	..Relay Package PT	page 170

Circuit Breakers

W28	..Circuit Breaker W28	page 171
W58	..Circuit Breaker W58	page 173
W6/W9	..Circuit Breaker W6/W9	page 175

Safety Relays / Definitions	page 180
Relay Definitions	page 182

Conversion table Part Numbers - Product Key	page 190
---	----------

PCB Power Relays

Miniature PCB Relay PE

1 pole 5 A

- 1 C/O
- Cadmium-free contacts
- Sensitive coil 200 mW
- 4 kV coil-contact
- Low height 10.0 mm

Miniature PCB Relay PE bistable

1 pole 5 A
polarized bistable version

- 1 C/O
- Bistable with 1 coil
- 4 kV coil-contact
- Low height 10.0 mm



Contacts

Configuration	1 C/O
Rated current	5 A
Rated voltage	250 Vac
Breaking capacity	1250 VA

Configuration	1 C/O
Rated current	5 A
Rated voltage	250 Vac
Breaking capacity	1250 VA

Configuration	1 C/O
Rated current	5 A
Rated voltage	250 Vac
Breaking capacity	1250 VA

Coil

Nominal voltage	5...48 Vdc
Nominal coil power	200 mW
Other coil versions	-

Nominal voltage	5...48 Vdc
Nominal coil power	200 mW
Other coil versions	-

Nominal voltage	3...24 Vdc
Nominal coil power	360 mW
Other coil versions	-

Insulation

Dielectric strength	4000 V _{rms}
Clearance / creepage	3.2 / 4 mm

Dielectric strength	4000 V _{rms}
Clearance / creepage	3.2 / 4 mm

Dielectric strength	4000 V _{rms}
Clearance / creepage	3.2 / 4 mm

General data

Ambient temperature max.	+85 °C
Standard versions	flux proof, wash tight
Terminals	PCB
Dimensions l x w x h	20 x 10 x 10 mm

Ambient temperature max.	+85 °C
Standard versions	flux proof, wash tight
Terminals	PCB
Dimensions l x w x h	20 x 10 x 10 mm

Ambient temperature max.	+70 °C
Standard versions	flux proof, wash tight
Terminals	PCB
Dimensions l x w x h	20 x 10 x 10 mm

Databook

page 22

page 24

Accessories

-

-

Miniature PCB Relay RE

1 pole 6 A

- 1 N/O
- Sensitive coil 200 mW
- 4 kV coil-contact
- Optimized height 10.6 mm
- PCB area 200 mm²
- Wash tight



1 N/O
6 A
250 Vac
1500 VA
5...48 Vdc
200 mW
-
4000 V _{rms}
4 / 4 mm
+70 °C
wash tight
PCB
20 x 10 x 10.6 mm
page 26
-

Slim PCB Relay SNR

1 pole 6 A

- 1 C/O or 1 N/O
- Only 5 mm wide
- Cadmium-free contacts
- Sensitive coil 170 mW
- 4 kV coil-contact
- 6/8 mm creepage/clearance
- Protection class II



1 C/O or 1 N/O
6 A
250 Vac
1500 VA
5...48 Vdc
170 mW
-
4000 V _{rms}
6 / 8 mm
+85 °C
wash tight
PCB
28 x 5 x 15 mm
page 28
page 146

Miniature Power PCB Relay RY II

1 pole 8 A

- 1 C/O or 1 N/O or 1 N/C
- 5 kV / 8 mm coil-contact
- Protection class II (VDE 0700)
- Low height 12.3 mm
- Pinnings: 3.2 and 5 mm
- Sockets with PCB-type or screw-type terminals



1 C/O or 1 N/O or 1 N/C
8 A
250 Vac
2000 VA
5...48 Vdc
220 mW
-
5000 V _{rms}
8 / 8 mm
+85 °C
flux proof, wash tight
PCB
28.5 x 10.1 x 12.3 mm
page 31
page 147

Miniature Power PCB Relay MSR

1 pole 8 A

- 1 C/O or 1 N/O
- High inrush currents (TV4 = 65 A) with AgSnO contacts
- 4 kV / 8 mm coil-contact
- Protection class II
- Ambient temperature up to 85°C at 8 A



1 C/O or 1 N/O
8 A
250 Vac
2000 VA
3...60 Vdc
220 mW
-
4000 V _{rms}
8 / 8 mm
+85 °C
wash tight
PCB
28.6 x 10 x 15 mm
page 34
-

PCB Power Relays

Power PCB Relay RT1

1 pole 12 / 16 A,
DC- or AC-coil

- 1 C/O or 1 N/O
- Sensitive coil 400 mW, 0.75 VA
- 5 kV / 10 mm coil-contact
- Protection class II
- Ambient temperature 85°C (DC-coil)
- Height 15.7 mm



Power PCB Relay RT1 bistable

1 pole 16A,
polarized bistable version

- 1 C/O
- Bistable with 1 or 2 coils
- 5 kV/10 mm coil-contact
- Height 15.7 mm
- Cadmium-free contacts
- Protection class II (VDE 0700)



Power PCB Relay RT1 sensitive

1 pole 10 A,
highly sensitive version

- 1 C/O or 1 N/O
- Sensitive coil 250 mW
- 5 kV/10 mm coil-contact
- Protection class II (VDE 0700)
- Ambient temperature 85°C at rated load
- Height 15.7 mm



Contacts

Configuration	1 C/O or 1 N/O		1 C/O	1 C/O or 1 N/O
Rated current	12 A	16 A	16 A	10 A
Rated voltage	250 Vac		250 Vac	250 Vac
Breaking capacity	3000 VA	4000 VA	4000 VA	2500 VA

Coil

Nominal voltage	5...110 Vdc	24...230 Vac	5...24 Vdc	5...60 Vdc
Nominal coil power	400 mW	0.75 VA	400 / 600 mW	250 mW
Other coil versions	-		-	-

Insulation

Dielectric strength	5000 V _{rms}		5000 V _{rms}	5000 V _{rms}
Clearance / creepage	10 / 10 mm		10 / 10 mm	10 / 10 mm

General data

Ambient temperature max.	DC: +85 °C	AC: +70 °C	+85 °C	+85 °C
Standard versions	flux proof, wash tight		flux proof	flux proof, wash tight
Terminals	PCB		PCB	PCB
Dimensions l x w x h	29 x 12.7 x 15.7 mm		29 x 12.7 x 15.7 mm	29 x 12.7 x 15.7 mm

Databook

page 37

page 40

page 42

Accessories

page 149

page 149

page 149

Power PCB Relay RT1 Inrush

1 pole 16 A, for inrush peak currents up to 80 A

- 1 N/O
- Sensitive coil 400 mW
- 5 kV / 10 mm coil-contact
- Protection class II (VDE 0700)
- Ambient temperature 85°C
- Height 15.7 mm



1 N/O
16 A
250 Vac
4000 VA
5...110 Vdc
400 mW
-
5000 V _{rms}
10 / 10 mm
+85 °C
flux proof
PCB
29 x 12.7 x 15.7 mm
page 44
page 149

Power PCB Relay 429 03 Inrush

1 pole 10 A, for inrush peak currents up to 80 A

- 1 N/O
- Tungsten prerun contact
- Sensitive coil 480 mW
- 4 kV / 8 mm coil-contact
- Height 15.0 mm



1 N/O
10 A
250 Vac
2500 VA
6...60 Vdc
480 mW
-
4000 V _{rms}
8 / 8 mm
+70 °C
flux proof
PCB
28.5 x 12.5 x 15.0 mm
page 46
-

Power PCB Relay RTH 105°C sensitive

1 pole 10 A, high-temperature version

- 1 N/O
- Sensitive coil 250 mW
- 5 kV / 10 mm coil-contact
- Protection class II (VDE 0700)
- Ambient temperature 105°C at rated load
- Height 15.7 mm



1 N/O
10 A
250 Vac
2500 VA
5...60 Vdc
250 mW
-
5000 V _{rms}
10 / 10 mm
+105 °C
flux proof
PCB
29 x 12.7 x 15.7 mm
page 48
-

Power PCB Relay RTH 105°C 16 A

1 pole 16 A, high-temperature version

- 1 C/O or 1 N/O
- 16 A rated current
- 5 kV / 10 mm coil-contact
- Protection class II (VDE 0700)
- Ambient temperature 105°C at rated load
- Height 15.7 mm



1 C/O or 1 N/O
16 A
250 Vac
4000 VA
5...60 Vdc
400 mW
-
5000 V _{rms}
10 / 10 mm
+105 °C
flux proof
PCB
29 x 12.7 x 15.7 mm
page 50
-

PCB Power Relays

Power PCB Relay RP II/1

1 pole 8 / 12 / 16 A

- 1 C/O or 1 N/O
- 4 kV / 8 mm coil-contact
- Pinning 3.5 or 5 mm (8 / 12 A) and 5 mm (16 A)
- PCB-sockets



Special Load PCB Relay RP 3 SL

1 pole 16 A, for high inrush currents, mono- or bistable

- 1 N/O
- 120 A / 20 ms inrush peak current
- 4 kV / 8 mm coil-contact



Special Load PCB Relay 409

1 pole 10 A, for high inrush currents, mono- or bistable

- 1 N/O
- 500 A / 10 μ s inrush peak current
- Tungsten prerun contact
- 4 kV / 8 mm coil-contact



Contacts

Configuration	1 C/O or 1 N/O	1 N/O	1 N/O
Rated current	8 A 12 A 16 A	16 A	10 A
Rated voltage	250 Vac	250 Vac	250 Vac
Breaking capacity	2000 VA 3000 VA 4000 VA	4000 VA	2500 VA

Coil

Nominal voltage	6...110 Vdc	5...110 Vdc	5...110 Vdc
Nominal coil power	500 mW	500 mW	820 mW
Other coil versions	-	bistable	bistable

Insulation

Dielectric strength	4000 V _{rms}	4000 V _{rms}	4000 V _{rms}
Clearance / creepage	8 / 8 mm	8 / 8 mm	8 / 8 mm

General data

Ambient temperature max.	+70 °C	+70 °C	+70 °C
Standard versions	flux proof, wash tight	flux proof, wash tight	flux proof
Terminals	PCB	PCB	PCB
Dimensions l x w x h	29 x 12.6 x 25.5 mm	29 x 12.6 x 25.5 mm	28.5 x 12.2 x 25.3 mm

Databook

page 52

page 55

page 58

Accessories

page 149

page 149

-

Faston Power Relay IF 125°C

1 pole 16 A

- 1 N/O or 1 N/C
- Insulation to VDE 0631 and VDE 0700
- Ambient temperature up to 125°C
- Faston-terminals



Faston Power Relay 410 63 125°C

1 pole 16 A

- 1 N/O or 1 N/C
- Insulation to VDE 0631 and VDE 0700
- Ambient temperature up to 125°C
- Faston-terminals



Faston Power Relay 410 83 3 mm

1 pole 16 A

- 1 N/O
- Insulation to VDE 0631 and VDE 0700
- Faston-terminals
- Contact gap > 3 mm



Power PCB Relay Card E

1 pole 8 A

- 1 C/O or 1 N/O
- 4 kV coil-contact
- Vertical and horizontal version
- Version with twin contacts
- Wash tight



1 N/O or 1 N/C
16 A
250 Vac
4000 VA
6...48 Vdc
360 mW
-
4000 V _{rms}
8 / 8 mm
+125 °C
flux proof
PCB
29 x 13.2 x 29 mm
page 61
-

1 N/O or 1 N/C
16 A
250 Vac
4000 VA
6...60 Vdc
360 mW
-
4000 V _{rms}
8 / 8 mm
+125 °C
flux proof
PCB
29 x 12.5 x 28.5 mm
page 63
-

1 N/O
16 A
250 Vac
4000 VA
6...60 Vdc
360 mW
-
4000 V _{rms}
8 / 8 mm
+85°C
flux proof
PCB
29 x 12,5 x 28,5 mm
page 65
-

1 C/O or 1 N/O
8 A
250 Vac
2000 VA
6...60 Vdc
450...500 mW
-
4000 V _{rms}
4 / 4 mm
+70 °C
wash tight
PCB
28 x 10.4 x 25.1 mm
page 74
page 148

PCB Power Relays

Power PCB Relay RT2

2 pole 8 A,
DC and AC-coil

- 2 C/O or 2 N/O
- Sensitive coil 400 mW
- DC- or AC-coil
- 5 kV / 10 mm coil-contact
- Protection class II (VDE 0700)
- Height 15.7 mm



Power PCB Relay RT2 bistable

2 pole 8 A,
polarized bistable version

- 2 C/O
- Bistable with 1 or 2 coils
- 5 kV / 10 mm coil-contact
- Height 15.7 mm
- Cadmium-free contacts
- Protection class II (VDE 0700)



Power PCB Relay RP II/2

2 pole 8 A

- 2 C/O or 2 N/O
- 4 kV / 8 mm coil-contact
- Twin contacts available
- PCB-sockets



Contacts

Configuration	2 C/O or 2 N/O	2 C/O	2 C/O or 2 N/O
Rated current	8 A	8 A	8 A
Rated voltage	250 Vac	250 Vac	250 Vac
Breaking capacity	2000 VA	2000 VA	2000 VA

Coil

Nominal voltage	5...110 Vdc 24...230 Vac	5...24 Vdc	5..110 Vdc
Nominal coil power	400 mW 0.75 VA	400 / 600 mW	500 mW
Other coil versions	-	-	-

Insulation

Dielectric strength	5000 V _{rms}	5000 V _{rms}	4000 V _{rms}
Clearance / creepage	10 / 10 mm	10 / 10 mm	8 / 8 mm

General data

Ambient temperature max.	+70 °C	+85 °C (UL: 70 °C)	+70 °C
Standard versions	flux proof, wash tight	flux proof	flux proof, wash tight
Terminals	PCB	PCB	PCB
Dimensions l x w x h	29 x 12.7 x 15.7 mm	29 x 12.7 x 15.7 mm	29 x 12.6 x 25.5 mm

Databook

page 67

page 70

page 72

Accessories

page 149

page 149

page 149

Power PCB Relay U/UB

1 pole 7 A, mono or bistable

- 1 C/O or 1 N/O or 1 N/C
- Bistable and DC-version
- Versions with 230 mW or 180 mW pull-in power



1 C/O or 1 N/O or 1 N/C	
7 A	
250 Vac	
1750 VA	
6...48 Vdc	
450 mW	330 mW
sensitive	
2000 V _{rms}	4000 V _{rms}
2.5 mm	3.5 mm
+70 °C	
wash tight	
PCB	
21.2 x 16.2 x 14.9 mm	
page 77	
-	

Low Profile PCB Relay PCD

1 pole 10 A

- 1 N/O
- Low coil power 200 mW
- Height 10.2 mm
- Wash tight



1 N/O	
10 A	
250 Vac	
2500 VA	
6...24 Vdc	
200 mW	
-	
2500 V _{rms}	
4 mm	
+70 °C	
flux proof, wash tight	
PCB	
23 x 15.9 x 10.2 mm	
page 80	
-	

Miniature Power PCB Relay PB

1 pole 10 A

- 1 C/O or 1 N/O contact
- Environmentally-friendly cadmium-free contacts
- Creepage/clearance to VDE 0435 and VDE 0700
- Class F coil available



1 C/O or 1 N/O	
10 A	
250 Vac	
2500 VA	
5, 6, 12, 24 Vdc	
360 mW	
-	
2500 V _{rms}	
3 / 4 mm	
+85 °C	
flux proof	
PCB	
15 x 15 x 20 mm	
page 82	
-	

Miniature Power Relay T7N / T7N-WG

1 pole 10 A

- 1 C/O or 1 N/O
- Coil version 360 mW or 450 mW
- Ambient temperature up to 85°C
- Creepage- and clearance of base insulation according to VDE 0435 (T7N-WG: VDE 0700)



1 C/O or 1 N/O	
10 A	
250 Vac	
2500 VA	
6...48 Vdc	6...36 Vdc
360 mW	450 mW
-	
2000 V _{rms}	
2 / 3 mm	3 / 4 mm
+85 °C	
wash tight	
PCB	
22.5 x 16.5 x 16.9 mm	
page 84	
-	

PCB & Power Relays

Power Relay T9A

1 pole 25 A

- 1 N/O or 1 C/O
- High breaking capacity
- PCB- and Faston connections and chassis mount version
- UL-class F as standard
- Ambient temperature 85°C
- Open version available



Power Relay T92

2 pole 30 A, DC- and AC-coil

- 2 C/O or 2 N/O
- Switching capacity 7500 VA
- DC- or AC coil
- 4 kV / 8 mm coil-contact
- Insulation to VDE 0631 and VDE 0700
- PCB- or Faston connections or chassis mount



Contacts

Configuration	1 C/O	1 N/O	2 C/O or 2 N/O
Rated current	20(N/O)/10(N/C) A	25 A	30(N/O) / 3(N/C) A
Rated voltage	250 Vac		250 Vac
Breaking capacity	4800 VA	7200 VA	7500 VA

Coil

Nominal voltage	6...48 Vdc	6...48 Vdc	24...240 Vac
Nominal coil power	1 W	1.7 W	4.0 VA
Other coil versions	-	-	-

Insulation

Dielectric strength	2500 V _{rms}	4000 V _{rms}
Clearance / creepage	3.1 / 6.3 mm	8 / 9.5 mm

General data

Ambient temperature max.	+85 °C	DC: +85 °C	AC: +65 °C
Standard versions	wash tight	dust-proof, wash tight	
Terminals	PCB, Faston	PCB, Faston	
Dimensions l x w x h	32.3 x 27.4 x 20.4 mm	52.3 x 34.6 x 30.8 mm	

Databook

page 87

page 90

Accessories

-

-

Power Relay 430 3 mm

1 pole 16 A, DC- and AC-coil

- 1 N/O
- Safety mains insulation
- Contact gap > 3 mm
- Switching capacity 4000 VA
- DC- or AC coil
- 4 kV / 8 mm coil-contact
- PCB mounting or Faston connectors
- Mounting brackets or snap mounting



1 N/O
16 A
250 Vac
4000 VA

6...110 Vdc	6...240 Vac
1 W	1.8 VA
-	-

4000 V _{rms}
8 / 8 mm

+70°C
dust protected
PCB, Faston
35.5 x 16.4 x 28.5 mm

page 93

Power Relay 430

1 pole 16 A, DC- and AC-coil,
2 pole 10 A, DC- and AC-coil

- 1 or 2 pole, N/O, C/O and N/C
- 4 kV / 8 mm coil-contact
- DC- or AC coil
- PCB mounting or Faston connectors
- Mounting brackets or snap mounting



1 N/O, C/O, N/C	2 N/O, C/O, N/C
16 A	10 A
250 Vac	
4000 VA	2500 VA

6...110 Vdc	6...240 Vac
1 W	1.8 VA
-	-

4000 V _{rms}
8 / 8 mm

+70°C
dust protected
PCB, Faston
35.5 x 16.4 x 30.5 mm

page 96

Rast 5 Power Relay 419 01

2 pole 16 A, DC- and AC-coil

- 2 N/O
- Contact gap > 3 mm
- Switching capacity 4000 VA
- DC- or AC coil
- Safety mains insulation
- 4 kV / 8 mm coil-contact
- Faston connectors
- Snap or screw mount



2 N/O
16 A
250 Vac
4000 VA

6...24 Vdc	120...400 Vac
1.3 W	2.0...2.5 VA
-	-

4000 V _{rms}
8 / 8 mm

+90°C
dust protected
Faston
47 x 24 x 47 mm

page 99

Safety Relays

Safety Relay SR2M

2 pole 6 A

- Relay with forcibly guided contacts according to EN 50205
- 1 N/O + 1 N/C or 2 C/O
- 6 kV surge resistance between poles



Safety Relay SR4 D/M

4 pole 8 A

- Relay with forcibly guided contacts according to EN 50205
- 2 N/O + 2 N/C or 3 N/O + 1 N/C
- Small size



Safety Relay SR6 D/M

4 pole 8 A

- Relay with forcibly guided contacts according to EN 50205
- 2 N/O + 2 N/C or 3 N/O + 1 N/C
- High insulation distances for safe separation of electrical circuits



Contacts

Configuration	1 N/O + 1 N/C or 2 C/O	2N/O+2N/C or 3N/O+1N/C	2N/O+2N/C or 3N/O+1N/C
Rated current	6 A	8 A	8 A
Rated voltage	250 Vac	250 Vac	250 Vac
Breaking capacity	1500 VA	2000 VA	2000 VA

Coil

Nominal voltage	5...110 Vdc	5...110 Vdc	5...110 Vdc
Nominal coil power	700 mW	800 mW	1200 mW
Other coil versions	-	-	-

Insulation

Clearance / creepage coil-contact	8 / 8 mm	8 / 8 mm	5.5 / 5.5 mm
Clearance / creepage cont.-cont.	5.5 / 5.5 mm	3 / 3.5 mm	5.5 / 5.5 mm or 12 / 12 mm

General data

Ambient temperature max.	+70 °C	+70 °C	+70 °C
Standard versions	wash tight	wash tight	wash tight
Terminals	PCB	PCB	PCB
Dimensions l x w x h	29 x 12.6 x 25.5 mm	40 x 13 x 16 mm	55 x 16.5 x 16 mm

Databook

page 102

page 105

page 108

Accessories

page 150

-

-

Safety Relay SR6

6 pole 8 A

- Relay with forcibly guided contacts according to EN 50205
- Small size
- 4 N/O + 2 N/C,
3 N/O + 3 N/C,
5 N/O + 1 N/C



Safety Relay SR6 sensitive

6 pole 8 A

- Relay with forcibly guided contacts according to EN 50205
- polarized with 800 mW power consumption
- 4 N/O + 2 N/C,
3 N/O + 3 N/C,
5 N/O + 1 N/C



Safety Relay SR6Z

6 pole 8 A

- SR6 on printed circuit board
- 4 N/O + 2 N/C,
3 N/O + 3 N/C,
5 N/O + 1 N/C
- AC/DC input
- Spring connectors
- Module width 46 mm

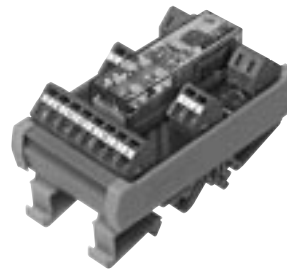

4N/O+2N/C, 3N/O+3N/C, 5N/O+1N/C
8 A
250 Vac
2000 VA

5...110 Vdc
1200 mW
-

5.5 / 5.5 mm
5.5 / 5.5 mm

+70 °C
wash tight
PCB
55 x 16.5 x 16 mm

page 110

4N/O+2N/C, 3N/O+3N/C, 5N/O+1N/C
8 A
250 Vac
2000 VA

5...48 Vdc
800 mW
-

5.5 / 5.5 mm
5.5 / 5.5 mm

+70 °C
wash tight
PCB
55 x 16.5 x 16 mm

page 113

4N/O+2N/C, 3N/O+3N/C, 5N/O+1N/C
8 A
250 Vac
2000 VA

12..115 Vdc/Vac, 230 Vac
1200 mW
-

5.5 / 5.5 mm
3 / 3 mm

+50 °C
-
spring connector terminals
87 x 46 mm

page 116

Industrial Relays

Slim Interface Relais SNR

1 pole 6 A

- 1 C/O 6 A
- Module width 5,08 mm
- Cadmium-free contacts
- Sensitive coil 170 mW
- 4 kV coil-contact
- 6/8 mm clearance/creepage
- Protection class II (VDE 0700)
- Safe separation to VDE0106



Interface Power Relay RT

1 pole 12 / 16 A, 2 pole 8 A, DC- or AC coil

- 1 C/O 12 or 16 A or 2 C/O 8 A
- Sensitive coil 400 mW
- Cadmium-free contacts
- Protection class II (VDE 0700)
- Safe separation to VDE0106
- 5 kV / 10 mm coil-contact



Miniature Relay PT

2 / 3 / 4 pole 12 / 10 / 6 A, DC- or AC-coil

- 2, 3 or 4 C/O
- Sensitive coil
- Low height 29 mm
- Cadmium-free contacts
- Mechanical indicator
- Manual test tab, optionally lockable
- C250 in 3 pole version



Contacts

Configuration	1 C/O	1 C/O	2 C/O	2 C/O	3 C/O	4 C/O
Rated current	6 A	12 / 16 A	8 A	12 A	10 A	6 A
Rated voltage	250 Vac	250 Vac		250 Vac		
Breaking capacity	1500 VA	3000 / 4000 VA	2000 VA	3000 VA	2500 VA	1500 VA

Coil

Nominal voltage	5...48 Vdc	6...110 Vdc	24...230Vac	6...220 Vdc	6...230 Vac	
Nominal coil power	170 mW	400 mW	0.75 VA	0.75 W	1.0 VA	
Other coil versions	-	see RT		-		

Insulation

Dielectric strength	4000 V _{rms}	5000 V _{rms}		2500 V _{rms}		
Clearance / creepage	6 / 8 mm	10 / 10 mm		3/4mm	2.6/4mm	1.8/3mm

General data

Ambient temperature max.	+85 °C	+70°C		+70°C		
Standard versions	flux proof	flux proof		dust-proof, flux proof		
Terminals	plug-in	plug-in		plug-in, PCB		
Dimensions l x w x h	28 x 5 x 15 mm	29 x 12.7 x 15.7 mm		28 x 22.5 x 29 mm		

Databook

page 118

page 120

page 123

Accessories

page 147

page 150

page 154

Multimode Relay MT

2 / 3 pole 10 A,
DC- or AC-coil

- 2 C/O or 3 C/O
- Cadmium-free contacts
- Mechanical indicator as standard and electrical indicator
- New front operated test system



2 C/O or 3 C/O
10 A
250 Vac
2500 VA

6...220Vdc	6...230 Vac
1.2 W	2.3 VA
-	-

2500 V _{rms}
2.8 / 4 mm

DC: +60 °C	AC: +50 °C
dust-proof	
plug-in	
35.5 x 35.5 x 57 mm	

page 129

page 158

Power Relay RM 2/3/7

2 / 3 pole 10 / 16 A,
DC- or AC-coil

- 2 C/O or 3 C/O
- Switching capacity up to 6000VA
- Mechanical indicator
- Push-to-test-button
- Plug-in version, PCB terminals, chassis- or DIN-rail mount



2 C/O	3 C/O	3 C/O
16 A	10 A	16 A
380 Vac		
6000 VA	3800 VA	6000 VA

6...220 Vdc	6...400 Vac
1.2...1.6 W	2.3...2.8 VA
-	-

2500 V _{rms}
3.5 / 6 mm

DC: +60/70 °C	AC: +50/55 °C
dust-proof	
plug-in, PCB	
38.5 x 35.5 x 48.5 mm	

page 132

page 162

Power Relay RM 5/6

2 / 3 pole 10 / 16 A,
DC- or AC-coil

- 2 N/O or 3 N/O
- 3 mm contact gap
- Push-to-test-button
- Plug-in version, PCB terminals, chassis- or DIN-rail mount



2 N/O	3 N/O
16 A	10 A
380 Vac	
6000 VA	3800 VA

6...220 Vdc	6...400 Vac
1.6 W	2.8 VA
-	-

2500 V _{rms}
3.5 / 6 mm

DC: +60 °C	AC: +50 °C
dust-proof	
plug-in, PCB	
38.5 x 35.5 x 48.5 mm	

page 136

page 162

Power Relay RM 8

2 pole 25 A, DC- or AC-coil

- 2 C/O
- Mechanical indicator
- Push-to-test-button
- Chassis- or DIN-rail mount



2 C/O
25 A
250 Vac
6000 VA

6...220 Vdc	6...400 Vac
1.2 W	2.8 VA
-	-

2500 V _{rms}
2.8 / 4 mm

DC: +65 °C	AC: +40 °C
dust-proof	
Faston	
38.5 x 35.5 x 48.5 mm	

page 140

-

Industrial Relays

Power Relay RMC/RMD

1 pole 30 A, DC- or AC-coil

- 1 N/O or 1 N/O + 1 N/C
- Switching capacity up to 7200 VA
- Push-to-test-button
- Chassis mount



Miniature Power Relay PCLH

2 pole 10 A, DC- or AC-coil

- 2 C/O
- Plug-in version, PCB or chassis mount version



Contacts

Configuration	1 N/O + 1 N/C	1 N/O	2 C/O
Rated current	30 A		10 A
Rated voltage	250 Vac		250 Vac
Breaking capacity	7500 VA		2500 VA

Coil

Nominal voltage	6...220 Vdc	6...400 Vac	12...48 Vdc	12...230Vac
Nominal coil power	1.2 W	2.8 VA	900 mW	1.2 VA
Other coil versions	-		-	

Insulation

Dielectric strength	2500 V _{rms}		1500 V _{rms}	
Clearance / creepage	2.8 / 4 mm		1.2 / 1.2 mm	

General data

Ambient temperature max.	DC: +60 °C	AC: +40 °C	+55 °C	
Standard versions	dust-proof		dust-proof	
Terminals	Faston		plug-in, PCB	
Dimensions l x w x h	38.5 x 35.5 x 48.5 mm		27.5 x 21.2 x 34.5 mm	

Databook

page 143

page 127

Accessories

-

page 161

Circuit Breakers

Circuit Breaker W28

1 pole 0.25...16 A

- Approved to international standards (push to reset type)
- Labor-saving snap-in mounting
- Button extends for visible trip indication



Circuit Breaker W58

1 pole 0.5...25 A

- 0.5...25 A ratings
- Cannot be manually tripped
- Push button to reset breaker
- Button extends for visible trip indication



Circuit Breaker W6 / W9 series

1...4 pole 0.2...50 A

- UL, CSA and VDE approved
- Ratings to 50 A
- Heavy duty stud connections
- Several delay curve options
- Trip free operation



Series	W28	W58	W6 / W9
Type	thermal	thermal	magnetic
Electrical data			
Number of poles	1	1	1...4
Current rating	0.25...16 A	0.5...25 A	0.2...50 A
Max. operating voltage	32 Vdc, 250 Vac	50 Vdc, 250 Vac	65 Vdc, 415 Vac
Interrupt capacity	1000 A at 32 Vdc or 250 Vac	2000 A at 50 Vdc 1000 A at 250 Vac	2000 A at 65 Vdc up to 5000 A at 250 Vac
General data			
Ambient temperature max.	+60 °C	+60 °C	+85 °C
Terminals	6.35 mm Quick Connect	6.35 mm Quick Connect screw terminals	6.35 mm Quick Connect stud terminal
Dimensions l x w x h	13.7 x 15.9 x 40 mm	16.8 x 34.9 x 34.9 mm	W6: 19.1 x 50.8 x 41.1 mm W9: 19.1 x 63.5 x 53 mm
Databook	page 167	page 169	page 171

Relay Range

The ordering code structure does allow a large number of possible variations, but not all possible variations are defined as standard types (ordering codes) and thus not included in the product range.

Special versions to customer specifications can be supplied. Please contact your local sales organisation.

Technical data in this catalog are guidelines for appropriate use under standard conditions. For additional information please contact our technical support.

Data subject to change without prior notice.

Relay Range

Terminals			Coil			Relay type	Page	Contacts		Switching current [A]
PCB	Plug-in	Solder/Faston	DC	AC	Bistable			C/O contacts	N/O contacts	
						PE	22			5
						PE bistable	24			5
						SNR	28			5
						U/UB	77			5
						RY II	31			5
						MSR	34			5
						Card E	74			5
						RP II/1	52			5
						RT1 sensitive	42			5
						RTH sensitive	48			5
						PB	82			5
						T7N / T7N-WG	84			5
						RT1	37			5
						RP II/1	52			5
						RT1	37			5
						RT1 Inrush	44			5
						RTH	50			5
						RP II/1	52			5
						430	96			5
						T9A	87			5
						RE	26			5
						PCD	80			5
						409 47	58			5
						429 03	46			5
						RP 3SL	55			5
						IF	61			5
						410 63	63			5
						410 83	65			5
						430 3mm	93			5
						T9A	87			5
						RMC/RMD	143			5
						RT 2	67			5
						RP II/2	72			5
						430	96			5
						MT	129			5
						PCLH	127			5
						PT	123			5
						RM 2	132			5
						RM 8	140			5
						RM 5	136			5
						419 01	99			5
						T92	90			5
						PT	123			5
						MT	129			5
						RM 3	132			5
						RM 7	132			5
						RM 6	136			5
						PT	123			5
						Safety Relays				
						SR2M	102			5
						SR4M	105			5
						SR6 DM	108			5
						SR6	110			5
						SR6 sensitive	113			5

S0345-G

Miniature PCB Relay PE

1 pole 5 A



Features

- 1 C/O contact
- Cadmium-free contacts
- Sensitive coil 200 mW
- 4 kV coil-contact
- Insulation according to IEC 255
- Ambient temperature 85°C
- Low height 10.0 mm

Applications

Industrial electronics, white goods, measurement and control

F0169-B



Technical data of approved types on request

Contact data

Configuration	1 C/O contact
Type of contact	single contact
Rated current	5 A
Rated voltage / max.breaking voltage AC	250 Vac / 440 Vac
Maximum breaking capacity AC	1250 VA
Contact material	AgNi 90/10

Contact ratings

Type	Load	Operations	Standard
PE 014	5A, 250 Vac, on the C/O contact	10 ⁵	VDE 0435
PE 014	20/2A, 250Vac, cosφ=0.3, on the N/O contact	1.2x10 ⁵	AC 15
PE 014	5 A, 250 Vac, on the C/O contact	1.5x10 ⁵	

Coil data

Nominal voltage	5...48 Vdc
Nominal coil power	typ. 200 mW
Operate category	2 / b

Coil versions, DC-coil

Coil code	Nominal voltage Vdc	Pull-in voltage Vdc	Release voltage Vdc	Maximum voltage Vdc	Coil resistance Ω	Coil current mA
005	5	3.8	0.5	13.2	125±10%	40.0
006	6	4.5	0.6	15.9	172±10%	34.9
012	12	9.0	1.2	31.8	685±10%	17.5
024	24	18.0	2.4	63.6	2725±10%	8.8
048	48	36.0	4.8	127.2	10970±10%	4.4

All figures are given for coil without preenergization, at ambient temperature +20°C

Other coil voltages on request

Max. DC load breaking capacity

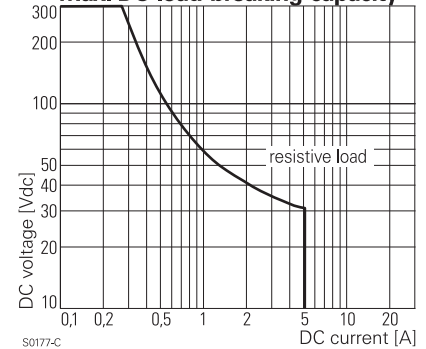

Electrical endurance

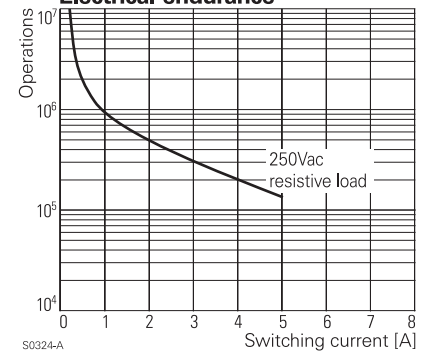

Coil operating range DC

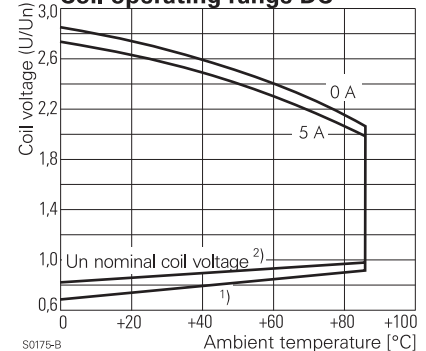

Miniature PCB Relay PE

1 pole 5 A

Insulation		
Dielectric strength	coil-contacts	4000 V _{rms}
	open contact circuit	1000 V _{rms}
Clearance / creepage		≥3.2 / 4 mm
Insulation to IEC 60664		
Voltage rating		250 V
Pollution degree		3
Overtoltage category		III
Tracking resistance of relay base		CTI 250

Other data	
Flammability class according to UL 94	V-0
Ambient temperature	-40...+85 °C
Mechanical life	15x10 ⁶ operations
Max. switching rate at rated- / minimum load	6 min ⁻¹ / 1200 min ⁻¹
Operate- / release time	typ. 5 / 2 ms
Bounce time N/O contact/N/C contact	typ. 1 / 5 ms
Vibration resistance N/O contact/N/C contact	>15 / 5 g
Shock resistance (destruction)	>100 g
Category of protection (IEC 61810)	RT II - flux proof (RT III - wash tight on request)
Relay weight	5 g
Packaging unit	25 / 500 pcs.

PCB layout / terminal assignment

View on solder pins
Dimensions in mm

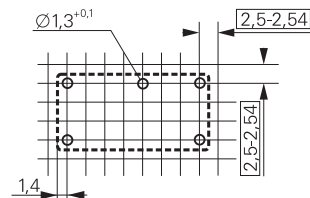

S0176-BA

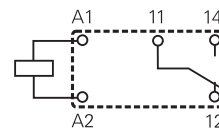

S0176-BB

Dimensions

Dimensions in mm

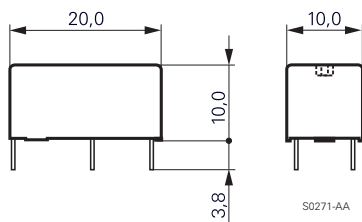

S0271-AA

Product key

Type

Version

0 flux proof *)

Contacts

1 1 C/O contact

Contact material

4 AgNi 90/10

Coil

Coil code: please refer to coil versions table



*) washable version on request

Product key	Version	Contacts	Contact material	Coil	Part number
PE014005	flux proof	1 C/O contact	AgNi 90/10	5 Vdc	0-1393219-3
PE014006				6 Vdc	0-1393219-4
PE014012				12Vdc	0-1393219-6
PE014024				24 Vdc	1-1393219-0
PE014048				48 Vdc	1-1393219-3

Miniature PCB Relay PE bistable

1pole 5 A, polarized bistable version



Features

- 1 C/O contact
- Cadmium-free contacts
- 4 kV coil-contact
- Insulation according to IEC 255
- Ambient temperature 70 °C
- Low height 10.0 mm

Applications

Room thermostats, electricity meters, domotic devices and white goods

F0221-A



Technical data of approved types on request

Contact data

Configuration	1 C/O contact
Type of contact	single contact
Rated current	5 A
Rated voltage / max.breaking voltage AC	250 Vac / 440 Vac
Maximum breaking capacity AC	1250 VA
Contact material	AgNi 90/10

Contact ratings

Type	Load	Operations	Standard
PE 014	5A, 250 Vac, on the C/O contact	10 ⁵	VDE 0435

Coil data

Nominal voltage	3...48 Vdc
Nominal coil power	typ. 360 mW
Minimum energization time	20 ms
Information on reduced pulse duration with higher energization voltages on demand	
Max. energization time	1 min at <10% duty cycle
Reset voltage max.	120 % U _{nom} at -40 °C

Coil versions, bistable, 1 coil

Coil code*	Nominal voltage Vdc	Pull-in voltage Vdc	Reset voltage Vdc	Coil resistance Ω	Coil current mA	
A02	C02	2.2	1.65	1.65	13±10%	163.0
A03	C03	3	2.25	2.25	25±10%	120.0
A05	C05	5	3.75	3.75	69±10%	72.0
A06	C06	6	4.5	4.5	100±10%	60.0
A12	C12	12	9.0	9.0	400±10%	30.0
A24	C24	24	18.0	18.0	1600±10%	15.0

All figures are given for coil without preenergization, at ambient temperature +20°C

* Coil codes A.. and C.. have opposite polarity; refer to coil operation table

Other coil voltages on request

Coils - operation

version	A..		C..	
coil terminals	A1	A2	A1	A2
pull-in	+	-	-	+
reset	-	+	+	-
Contact position not defined at delivery				

Max. DC load breaking capacity

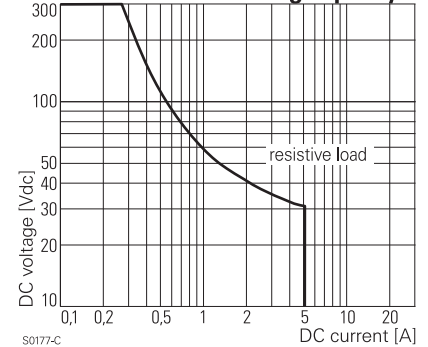

Electrical endurance

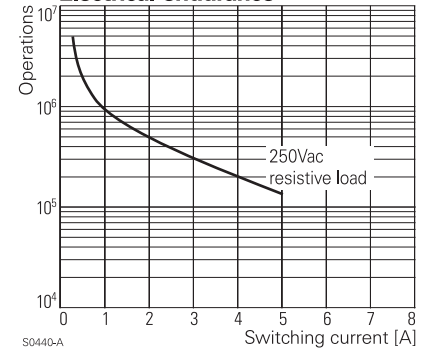

Coil operating range

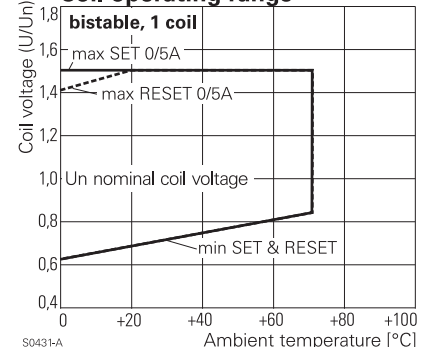

Miniature PCB Relay PE bistable

1pole 5 A, polarized bistable version

Insulation

Dielectric strength	coil-contacts	4000 V _{rms}
	open contact circuit	1000 V _{rms}
Clearance / creepage		≥3.2 / 4 mm
Insulation to IEC 60664		
Voltage rating		250 V
Pollution degree		3
Overtoltage category		III
Tracking resistance of relay base		CTI 250

Other data

Flammability class according to UL 94	V-0
Ambient temperature	-40...+70 °C
Mechanical life	5x10 ⁶ operations
Max. switching rate at rated- / minimum load	6 min ⁻¹ / 1200 min ⁻¹
Shock resistance (destruction)	>100 g
Category of protection (IEC 61810)	RT II - flux proof (RT III - wash tight, on request)
Relay weight	5 g
Packaging unit	25 / 500 pcs.

PCB layout / terminal assignment

View on solder pins
Dimensions in mm

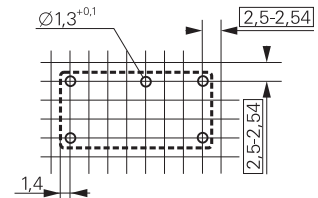

S0176-BA

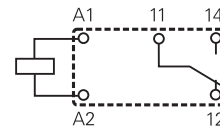

S0176-BB

Dimensions

Dimensions in mm

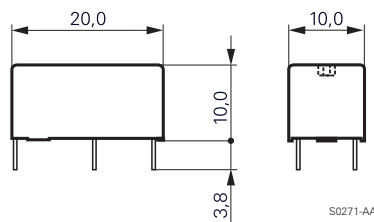

S0271-AA

Product key

Type

Version

0 flux proof *)

Contacts

1 1 C/O contact

Contact material

4 AgNi 90/10

Coil

Coil code: please refer to coil versions table



*) washable version on request

Product key	Version	Contacts	Cont. material	Coil	Coil	Part number
PE014A03	flux proof	1 C/O contact	AgNi 90/10	bistable	3 Vdc	4-1415064-1
PE014A05				1-coil	5 Vdc	7-1415063-1
PE014A06				polarity A	6 Vdc	3-1415053-1
PE014A12					12 Vdc	8-1415063-1
PE014A24					24 Vdc	9-1415063-1
PE014C03				bistable	3 Vdc	5-1415064-1
PE014C05				1-coil	5 Vdc	3-1415064-1
PE014C06				polarity C	6 Vdc	2-1415064-1
PE014C12					12 Vdc	1-1415064-1
PE014C24					24 Vdc	0-1415064-1

Miniature PCB Relay RE

1 pole 6 A



Features

- 1N/O contact
- Sensitive coil 200 mW
- 4 kV coil-contact
- Optimized height 10,6 mm
- PCB area 200 mm²
- Wash tight

Applications

PLC's, timers, temperature control, I / O cards



Technical data of approved types on request

F0141-A

Contact data

Configuration	1 N/O contact
Type of contact	single contact
Rated current	6 A
Rated voltage / max.breaking voltage AC	250 Vac / 440 Vac
Maximum breaking capacity AC	1500 VA
Make current (max. 4 s at duty cycle 10%)	15 A
Contact material	AgCdO, AgNi 0.15 gold plated

Contact ratings

Type	Load	Operations	Standard
RE 030	2 A, 400 Vac, AC 11	2x10 ⁵	VDE 0660
RE 030	2 A, 250 Vac, AC 11	4x10 ⁵	VDE 0660
RE 030	0.33 A, 250 Vac, AC 11	5x10 ⁶	VDE 0660
RE 030	1/8hp, 120 Vac	3x10 ⁴	UL 508
RE 030	1/4hp, 240 Vac	3x10 ⁴	UL 508
RE 030	B 300		UL 508
RE 030	6 A, 30 Vdc, resistive	5x10 ⁵	
RE 030	0.3 A, 50 Vdc, L/R=40 ms	3x10 ⁶	
RE 030	6 (3) A, 250 Vac	1x10 ⁵	VDE 0631

Coil data

Nominal voltage	5...48 Vdc
Nominal coil power	200 mW
Operate category	2 / b

Coil versions, DC-coil

Coil code	Nominal voltage Vdc	Pull-in voltage Vdc	Release voltage Vdc	Maximum voltage Vdc	Coil resistance Ω	Coil current mA
005	5	3.5	0.5	13.5	125±10%	40.0
006	6	4.2	0.6	16.2	180±10%	33.3
012	12	8.4	1.2	32.4	720±10%	16.7
024	24	16.8	2.4	64.8	2880±15%	8.3
048	48	33.6	4.8	129.6	11520±15%	4.2

All figures are given for coil without preenergization, at ambient temperature +20°C, single mounting

Other coil voltages on request

Max. DC load breaking capacity

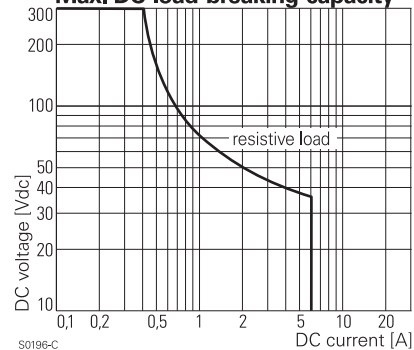

Electrical endurance

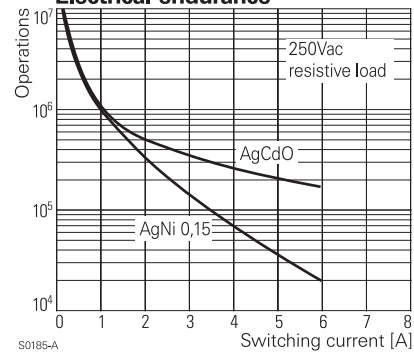

Coil operating range DC

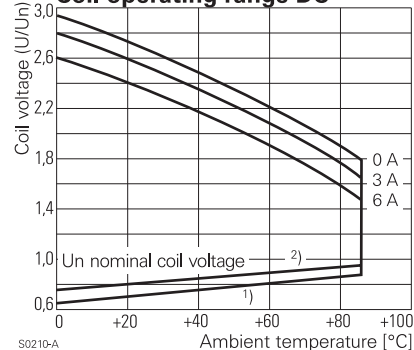

Miniature PCB Relay RE

1 pole 6 A

Insulation		
Dielectric strength	coil-contacts	4000 V _{rms}
	open contact circuit	1000 V _{rms}
Clearance / creepage		≥ 4 / 4 mm
Insulation to IEC 60664		
Voltage rating		250 V
Pollution degree		3
Overvoltage category		III
Insulation to VDE 0110b (2/79)		
Insulation category / reference voltage		C / 250, B / 400

Other data		
Flammability class according to UL 94		V-0
Ambient temperature		-40...+70 °C, -40...+85 °C at 4 A
Mechanical life		> 30x10 ⁶ operations
Max. switching rate at rated- / minimum load		6 min ⁻¹ / 1200 min ⁻¹
Operate- / release time		typ. 5 / 1 ms
Bounce time		typ. 1 ms
Vibration resistance	open contact:	10 g
	closed contact:	20 g
Shock resistance (destruction)		100 g
Category of protection (IEC 61810)		RT III - wash tight
Relay weight		5 g
Packaging unit		25 / 500 pcs.

PCB layout / terminal assignment

View on solder pins
Dimensions in mm

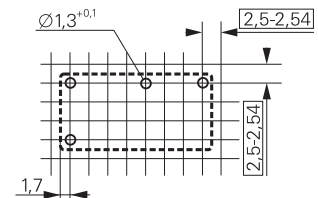

S0176-BH

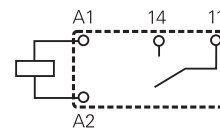

S0176-BJ

Dimensions

Dimensions in mm

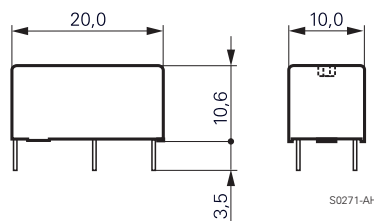

Product key

Type

Version

0 wash tight

Contacts

3 1 N/O contact

Contact material

0 AgCdO

2 AgNi 0,15 gold plated

Coil

Coil code: please refer to coil versions table



Product key	Version	Contacts	Contact material	Coil	Part number
RE030005	wash tight	1 N/O contact	AgCdO	5 Vdc	0-1393217-1
RE030006				6 Vdc	0-1393217-2
RE030012				12 Vdc	0-1393217-4
RE030024				24 Vdc	0-1393217-8
RE030048			48 Vdc	1-1393217-1	
RE032005			AgNi 0,15 gold plated	5 Vdc	1-1393217-9
RE032006				6 Vdc	2-1393217-0
RE032012				12 Vdc	2-1393217-2
RE032024				24 Vdc	2-1393217-4
RE032048				48 Vdc	2-1393217-5

Slim PCB Relay PCN

1 pole 3 A



PCN-02b-c

Features

- 1 N/O contact
- Only 5 mm slim
- 3 A switching current
- Load range 1 mA up to 3 A
- Sensitive coil 120 mW
- Allows high function-/packing density
- Cadmium-free contacts
- Z type with reinforced insulation

Applications

Centralized and decentralized heating control, extremely narrow interface elements, interface technology, timers, PLC's, I/O modules, I/O-ports



Technical data of approved types on request

Contact data

Configuration	1 N/O contact
Type of contact	bifurcated contact
Rated current	3 A
Rated voltage / max.breaking voltage AC	250 Vac / 277 Vac
Maximum breaking capacity AC	1250 VA
Contact material	AgNi
Minimum contact load	5 Vdc / 1 mA

Contact ratings

Type	Load	Operations
	3 A / 250 Vac, resistive	1x10 ⁵
	3 A / 30 Vdc, resistive	1x10 ⁵

Coil data

Nominal voltage	5...24 Vdc
Nominal coil power	120 mW
Operate power	58.8 mW
Operate category	1

Coil versions

Coil code	Nominal voltage Vdc	Pull-in voltage Vdc	Release voltage Vdc	Maximum voltage Vdc	Coil resistance Ω	Coil current mA
05	5	3.5	0.5	6.5	208 \pm 10%	24.0
06	6	4.2	0.6	7.8	300 \pm 10%	20.0
09	9	6.3	0.9	11.7	675 \pm 10%	13.3
12	12	8.4	1.2	15.6	1200 \pm 10%	10.0
24	24	16.8	2.4	31.2	4800 \pm 10%	5.0

All figures are given for coil without preenergization, at ambient temperature +20°C
Other coil voltages on request

Max. DC load breaking capacity

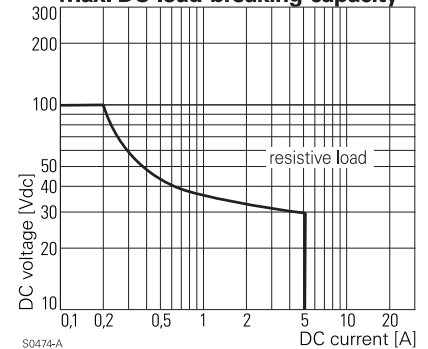

S0474-A

Electrical endurance

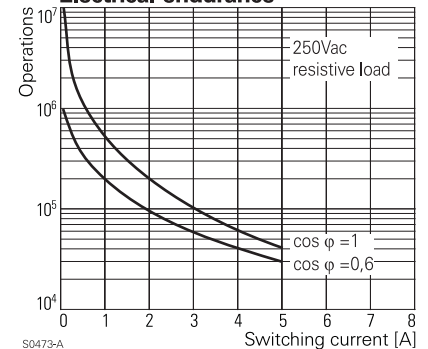

S0473-A

Coil operating range DC

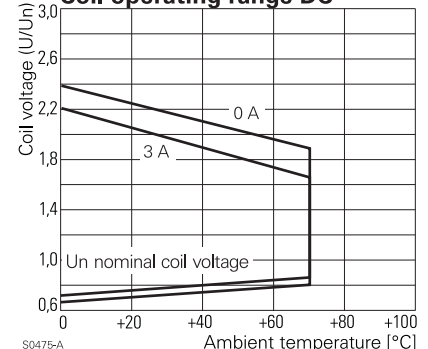

S0475-A

Slim PCB Relay PCN

1 pole 3 A

Insulation		
Dielectric strength	coil-contacts	3000 V _{rms}
	open contact circuit	750 V _{rms}
Surge voltage resistance	coil-contacts	5000 V (1.2 / 50 μs)
Clearance / creepage		3.5 mm
Insulation to IEC 664/VDE 0110		
	Voltage rating	277 Vac
	Pollution degree	2
	Overvoltage category	II
Tracking resistance of relay base		PTI 600

PCB layout / terminal assignment

View on solder pins
Dimensions in mm

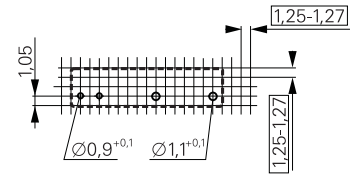

S0471-AA

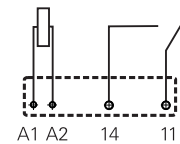

S0471-AB

Other data	
Flammability class according to UL 94	V-0
Ambient temperature	-30...+70 °C
Mechanical life	20x10 ⁶ operations
Max. switching rate at rated- / minimum load	10 min ⁻¹ / 1200 min ⁻¹
Operate- / release time typ.	5 / 2 ms
Bounce time N/O contact typ.	< 1 ms
Category of protection (IEC 61810)	RT III - wash tight
Relay weight	3 g
Packaging unit	25 / 2000

Dimensions

Dimensions in mm

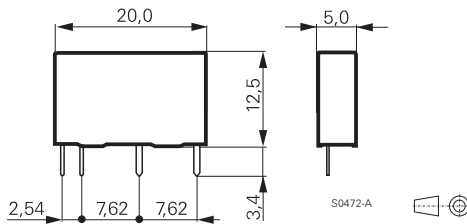

Product key



Type

Number of contacts

1 1 pole

Coil

coil code: please refer to coil versions table

Coil version

D standard 120 mW

Contact material

3 AgNi

Contact configuration

M 1 N/O contact

Version

H wash tight

Insulation

Z high insulation

Other types on request

Product key	Contacts	Coil	Coil	Contacts	Version	Part number
PCN-105D3MHZ	1-pole	5 Vdc	standard	1 N/O	wash tight	3-1461491-0
PCN-106D3MHZ		6 Vdc	120 mW	AgNi	high insulation	3-1461491-1
PCN-112D3MHZ		12 Vdc				3-1461491-3
PCN-124D3MHZ		24 Vdc				3-1461491-6

Slim PCB Relay SNR

1 pole 6 A



F0140-C

Features

- 1 C/O or 1 N/O contact
- Only 5 mm wide
- 6 A switching current
- Sensitive coil 170 mW
- 4 kV coil-contact, 6 / 8 mm clearance/creepage
- N/O version with 8 / 8 mm clearance/creepage on request
- Protection class II
- Allows high function-/packing density
- Cadmium-free contacts, AgNi 90/10 for AC-loads

Applications

Centralized and decentralized heating control, extremely narrow interface elements, interface technology, timers, PLC's, I/O modules, I/O-ports



Technical data of approved types on request

Contact data

Configuration	1 C/O contact or 1 N/O contact		
Type of contact	single contact		
Rated current	6 A		
Rated voltage / max.breaking voltage AC	250 Vac / 440 Vac		
Maximum breaking capacity AC	1500 VA		
Contact material	AgSnO ₂ gold plated	AgSnO ₂	AgNi90/10
Minimum contact load	≥10 mA 5 V	≥100 mA 12 V	≥100 mA 12 V

Contact ratings

Type	Load	Operations
-A302	5 A, 250 Vac, resistive	1x10 ⁵
-A302	2 A, 250 Vac, cosφ0.4	2x10 ⁵
-A302	1 A, 24 Vdc, L / R=48 ms	2x10 ⁵

Coil data

Nominal voltage	5...48 Vdc
Nominal coil power	170 mW
Operate power	75 mW...95 mW
Operate category	2 / b

Coil versions

Coil code	Nominal voltage Vdc	Pull-in voltage Vdc	Release voltage Vdc	Maximum voltage Vdc	Coil resistance Ω	Coil current mA
005	5	3.5	0.25	11.2	147±10%	34.0
012	12	8.4	0.6	26.8	848±10%	14.2
024	24	16.8	1.2	53.7	3390±10%	7.1
048	48	33.6	2.4	100.0	10600±15%	4.5

All figures are given for coil without preenergization, at ambient temperature +20°C
Other coil voltages on request

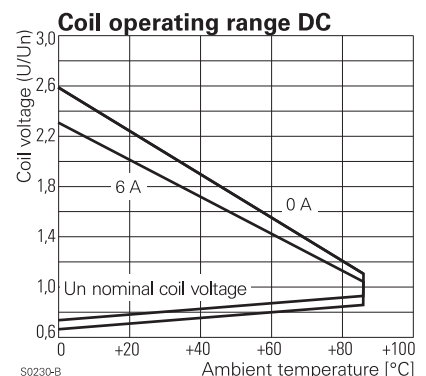
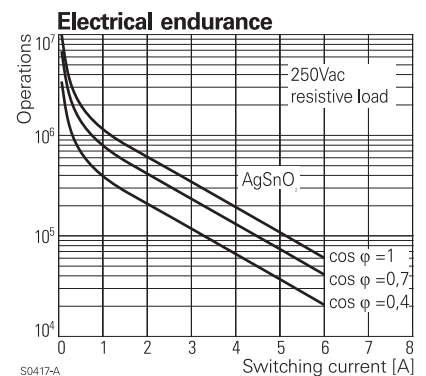
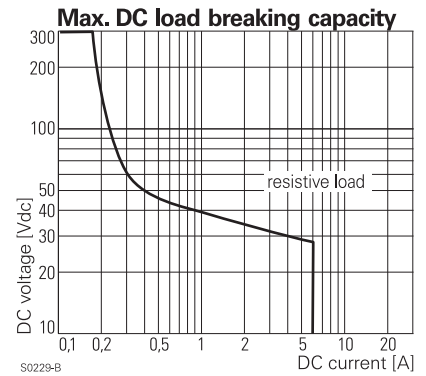

Slim PCB Relay SNR

1 pole 6 A

Insulation		
Dielectric strength	coil-contacts	4000 V _{rms}
	open contact circuit	1000 V _{rms}
Surge voltage resistance	coil-contacts	6000 V (1.2 / 50 μs)
Clearance / creepage (standard)		6 / 8 mm
Insulation to IEC 664/VDE 0110 (04 / 97)		
Voltage rating		250 V
Pollution degree		3
Overvoltage category		III
Insulation to VDE 0110b (2/79)		
Insulation category / reference voltage		C / 250
Tracking resistance of relay base		CTI 250

PCB layout / terminal assignment

View on solder pins
Dimensions in mm

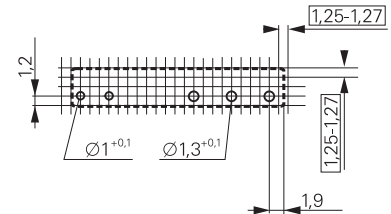

S0258-AA

Other data	
Flammability class according to UL 94	V-0
Ambient temperature	-40...+85 °C
Mechanical life	10x10 ⁶ operations
Max. switching rate at rated- / minimum load	6 min ⁻¹ / 20 s ⁻¹
Operate- / release time	5 / 2.5 ms
Bounce time N/O contact/N/C contact	1.5 / 5 ms
Category of protection (IEC 61810)	RT III - wash tight
Relay weight	6 g
Packaging unit	20 / 1000 pcs.
Accessories	see accessories SNR

1 C/O contact

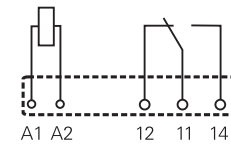

S0258-AB

1 N/O contact

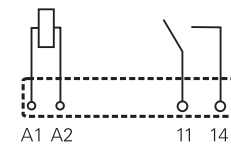

S0258-AC

Dimensions

Dimensions in mm

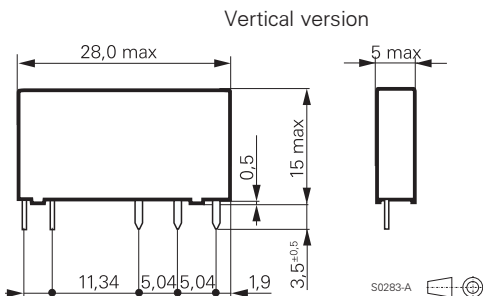

Flat pack version

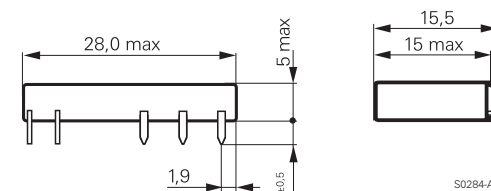

Product key



Type		
Version	A PCB vertical version	B PCB flat pack version
Version	1 wash tight	
Coil	Coil code: please refer to coil versions table	
Contact system	A standard	
Contact material	2 AgSnO ₂ , gold plated	3 AgSnO ₂
	8 AgNi 90/10	
Contact configuration	01 1 C/O contact	02 1 N/O contact

N/O version with 8/8mm clearance and creepage and other types on request

Slim PCB Relay SNR

1 pole 6 A

Product key	Version	Contacts	Contact material	Coil	Part number
V23092-A1005-A201	PCB	1 C/O contact	AgSnO, gold pl.	5 Vdc	0-1393236-1
V23092-A1005-A202	vertical version	1 N/O contact			8-1415067-1
V23092-A1005-A301	wash tight	1 C/O contact	AgSnO		0-1393236-2
V23092-A1005-A302		1 N/O contact			9-1415067-1
V23092-A1005-A801		1 C/O contact	AgNi 90/10		1-1415068-1
V23092-A1005-A802		1 N/O contact			0-1415068-1
V23092-A1012-A201		1 C/O contact	AgSnO, gold pl.	12 Vdc	0-1393236-4
V23092-A1012-A202		1 N/O contact			0-1393236-5
V23092-A1012-A301		1 C/O contact	AgSnO		0-1393236-7
V23092-A1012-A302		1 N/O contact			0-1393236-8
V23092-A1012-A801		1 C/O contact	AgNi 90/10		1-1393236-3
V23092-A1012-A802		1 N/O contact			2-1415068-1
V23092-A1024-A201		1 C/O contact	AgSnO, gold pl.	24 Vdc	2-1393236-1
V23092-A1024-A202		1 N/O contact			2-1393236-2
V23092-A1024-A301		1 C/O contact	AgSnO		2-1393236-4
V23092-A1024-A302		1 N/O contact			2-1393236-5
V23092-A1024-A801		1 C/O contact	AgNi 90/10		3-1393236-0
V23092-A1024-A802		1 N/O contact			5-1415063-1
V23092-A1048-A201		1 C/O contact	AgSnO, gold pl.	48 Vdc	3-1393236-5
V23092-A1048-A202		1 N/O contact			3-1393236-6
V23092-A1048-A301		1 C/O contact	AgSnO		3-1393236-7
V23092-A1048-A302		1 N/O contact			3-1393236-8
V23092-A1048-A801		1 C/O contact	AgNi 90/10		3-1393236-9
V23092-A1048-A802		1 N/O contact			3-1415068-1

Miniature Power PCB Relay RY II

1 pole 8 A



F0142-C

Features

- Low component height 12.3 mm
- 1 C/O or 1 N/O or 1 N/C contact
- 5 kV / 8 mm coil-contact
- Protection class II (VDE 0700)
- Pinnings: 3.2 and 5 mm
- Sockets with PCB-type or screw-type terminals
- Especially suitable for resistive and inductive loads on N/O and N/C contacts

Applications

Heating control, interface technology, domestic appliances, timers, temperature control



Technical data of approved types on request

Contact data

Configuration	1 C/O contact, 1 N/O contact, 1 N/C contact
Type of contact	single contact
Rated current	8 A
Rated voltage / max.breaking voltage AC	250 Vac / 440 Vac
Maximum breaking capacity AC	2000 VA
Make current (max. 4 s at duty cycle 10%)	30 A
Contact material	AgCdO, AgNi 0.15, AgSnO ₂

Contact ratings

Type	Load	Operations	Standard
RY610	B 300, 120 Vac, 70 °C		UL 508
RY610	B 300, 240 Vac, 70 °C		UL 508
RY610	1 / 4 hp, 120 Vac, 70 °C		UL 508
RY610	1 / 2 hp, 240 Vac, 70 °C		UL 508
RY610	8 A, 28 Vdc, 70 °C	>3x10 ⁴	UL 508
RY610	0.28 A, 250 Vdc, 70 °C	>3x10 ⁴	UL 508
RY531	6 (4) A, 250 Vac, 85 °C	1x10 ⁵	VDE 0631

Coil data

Nominal voltage	5...48 Vdc
Nominal coil power	approx. 220 mW
Operate category	2 / b

Coil versions

Coil code	Nominal voltage Vdc	Pull-in voltage Vdc	Release voltage Vdc	Maximum voltage Vdc	Coil resistance Ω	Coil current mA
005	5	3.5	0.5	11.8	113±10%	44.0
006	6	4.2	0.6	14.1	164±10%	36.7
012	12	8.4	1.2	28.2	620±10%	19.3
024	24	16.8	2.4	56.4	2350±10%	10.2
048	48	33.6	4.8	112.8	9600±10%	5.0

All figures are given for coil without preenergization, at ambient temperature +20°C

Other coil voltages on request

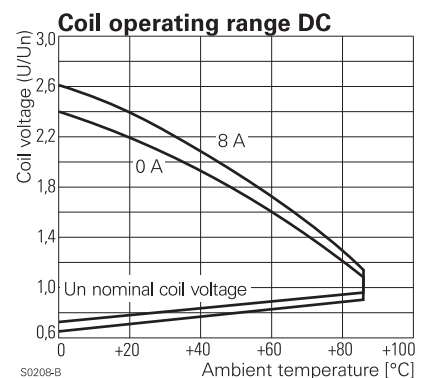
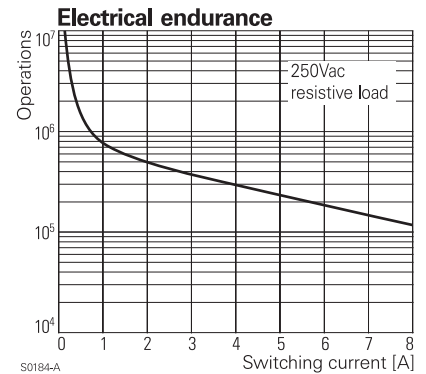
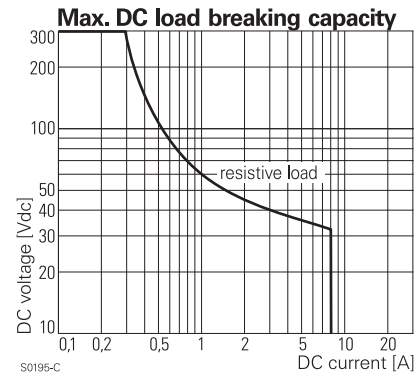

Miniature Power PCB Relay RY II

1 pole 8 A

Insulation		
Dielectric strength	coil-contacts	5000 V _{rms}
	open contact circuit	1000 V _{rms}
Clearance / creepage		8 / 8 mm
Insulation to IEC 60664		
Voltage rating		250 V
Pollution degree		3
Overvoltage category		III
Insulation to VDE 0110b (2/79)		
Insulation category / reference voltage		C / 250
Tracking resistance of relay base		CTI 250

Other data	
Ambient temperature	-40...+85 °C
Mechanical life	30x10 ⁶ operations
Max. switching rate at rated- / minimum load	6 min ⁻¹ / 20 s ⁻¹
Operate- / release time	7 / 3 ms
Bounce time N/O contact	1 ms
Vibration resistance N/O / N/C contact	20 / 5 g, 10...500 Hz
Shock resistance (destruction)	100 g
Category of protection (IEC 61810)	RT II - flux proof, RT III - wash tight
Relay weight	8 g
Packaging unit	20 / 500 pcs.
Accessories	see accessories RY

Dimensions

Dimensions in mm

Pinning 3.2 mm

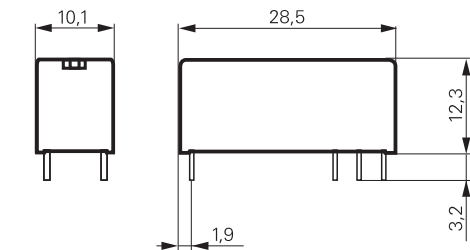

S0274-AA

Pinning 5 mm

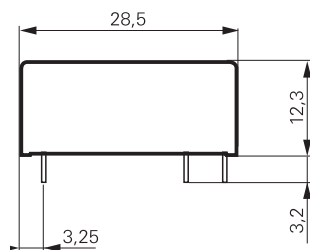

S0274-AB

PCB layout / terminal assignment

1 C/O contact, 3.2 mm

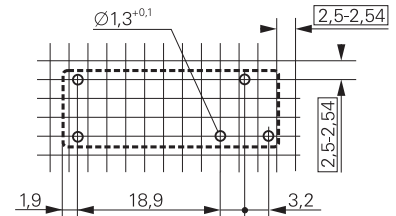

S0254-AA

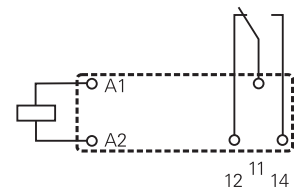

S0254-AB

1 N/O contact, 5 mm

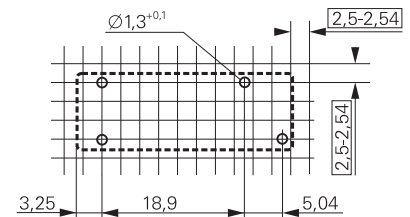

S0254-AC

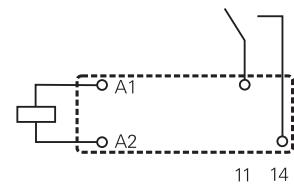

S0254-AD

View on solder pins
Dimensions in mm

Product key

Type

Version

2 pinning 3.2 mm, flux proof
5 pinning 5 mm, flux proof

6 pinning 3.2 mm, wash tight
A pinning 5 mm, wash tight

Contacts

1 1 C/O contact, pinning 3.2 mm

3 1 N/O contact, pinning 5 mm

Contact material

0 AgCdO
1 AgNi0.15

2 AgNi0.15 gold plated
3 AgSnO₂

Coil

Coil code: please refer to coil versions table

Other types on request

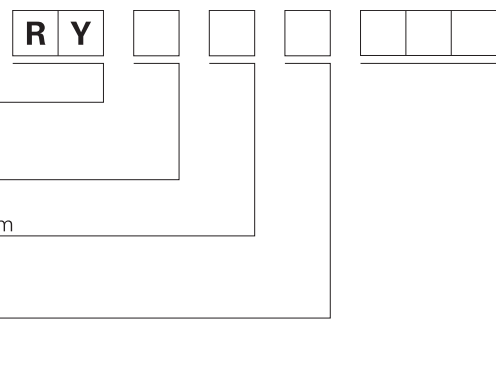

Miniature Power PCB Relay RY II

1 pole 8 A

Product key	Version	Contacts	Contact material	Coil	Part number	
RY210005	pinning 3.2 mm flux proof	1 C/O contact	AgCdO	5 Vdc	3-1393224-1	
RY210012				12 Vdc	3-1393224-5	
RY210024				24 Vdc	3-1393224-8	
RY210048				48 Vdc	4-1393224-1	
RY211005			AgNi 0.15	5 Vdc	4-1393224-2	
RY211012				12 Vdc	4-1393224-6	
RY211024				24 Vdc	4-1393224-9	
RY211048				48 Vdc	5-1393224-1	
RY212005				AgNi 0.15 gold plated	5 Vdc	5-1393224-2
RY212012					12 Vdc	5-1393224-5
RY212024					24 Vdc	5-1393224-8
RY212048					48 Vdc	5-1393224-9
RY213005			AgSnO	5 Vdc	6-1393224-0	
RY213012				12 Vdc	6-1393224-1	
RY213024	24 Vdc	6-1393224-2				
RY213048	48 Vdc	6-1393224-3				
RY530005	pinning 5 mm flux proof	1 N/O contact	AgCdO	5 Vdc	6-1393224-6	
RY530012				12 Vdc	6-1393224-9	
RY530024				24 Vdc	7-1393224-2	
RY530048				48 Vdc	7-1393224-4	
RY531005			AgNi 0.15	5 Vdc	7-1393224-6	
RY531012				12 Vdc	7-1393224-9	
RY531024				24 Vdc	8-1393224-2	
RY531048				48 Vdc	8-1393224-3	
RY532012			AgNi 0.15 gold plated	12 Vdc	8-1393224-4	
RY532024				24 Vdc	8-1393224-5	
RY533012			AgSnO	12 Vdc	8-1393224-8	
RY533024				24 Vdc	8-1393224-9	
RY533048				48 Vdc	9-1393224-0	
RY610005				pinning 3.2 mm wash tight	1 C/O contact	AgCdO
RY610012	12 Vdc	1-1393225-0				
RY610024	24 Vdc	1-1393225-4				
RY610048	48 Vdc	1-1393225-5				
RY611005	AgNi 0.15	5 Vdc	1-1393225-7			
RY611012		12 Vdc	1-1393225-9			
RY611024		24 Vdc	2-1393225-1			
RY611048		48 Vdc	2-1393225-2			
RY612005	AgNi 0.15 gold plated	5 Vdc	2-1393225-3			
RY612012		12 Vdc	2-1393225-6			
RY612024		24 Vdc	2-1393225-9			
RY612048		48 Vdc	3-1393225-0			
RY613005	AgSnO	5 Vdc	5-1419136-2			
RY613012		12 Vdc	3-1393225-1			
RY613024		24 Vdc	3-1393225-3			
RY613048		48 Vdc	3-1393225-4			
RYA30005	pinning 5 mm wash tight	1 N/O contact	AgCdO	5 Vdc	0-1393224-1	
RYA30012				12 Vdc	0-1393224-4	
RYA30024				24 Vdc	0-1393224-6	
RYA30048				48 Vdc	7-1393225-7	
RYA31005			AgNi 0.15	5 Vdc	0-1393224-7	
RYA31012				12 Vdc	0-1393224-9	
RYA31024				24 Vdc	1-1393224-2	
RYA31048				48 Vdc	1-1393224-3	
RYA32005			AgNi 0.15 gold plated	5 Vdc	1-1393224-4	
RYA32012				12 Vdc	1-1393224-6	
RYA32024				24 Vdc	1-1393224-8	
RYA33005				AgSnO	5 Vdc	1-1393224-9
RYA33024			24 Vdc		2-1393224-1	

Miniature Power PCB Relay MSR

1 pole 8 A



Features

- 1C/O or 1N/O contact
- High inrush currents with AgSnO contacts (TV4 = 65 A)
- 4 kV/8 mm coil-contact
- Protection class II
- Ambient temperature up to 85°C at 8 A

Applications

HVAC, interface technology, power supplies, TV-/Monitor control, computer-/communication technology, domestic appliances, Hi-Fi products, timers

F0143-C



Technical data of approved types on request

Contact data

Configuration	1 C/O contact or 1 N/O contact
Type of contact	single contact
Rated current	8 A
Rated voltage / max.breaking voltage AC	250 Vac / 440 Vac
Maximum breaking capacity AC	2000 VA
Make current (max. 4 s at duty cycle 10%)	15 A
Contact material	AgSnO ₂ , AgCdO, AgNi 0.15

Contact ratings

Type	Load	Operations	Standard
-A402	8 A, 240 Vac, resistive	1x10 ⁵	UL 508
-A302	30 / 3 A, 230 Vac, AC15	3x10 ⁵	VDE 0660
-A302	65 / 4 A, 120 Vac, TV4	25x10 ³	UL 508

Coil data

Nominal voltage	3...60 Vdc
Nominal coil power	approx. 220 mW
Operate category	2 / b

Coil versions

Coil code	Nominal voltage Vdc	Pull-in voltage Vdc	Release voltage Vdc	Maximum voltage Vdc	Coil resistance Ω	Coil current mA
002	5	3.4	0.5	12.5	118±10%	42.4
003	6	4.1	0.6	15.0	165±10%	36.4
005	12	8.2	1.2	30.0	650±10%	18.5
007	24	16.3	2.4	56.0	2270±10%	10.6
009	48	32.6	4.8	110.0	8790±10%	5.5
010	60	40.8	6.0	142.0	15265±15%	4.0

All figures are given for coil without preenergization, at ambient temperature +20°C

Other coil voltages on request

Max. DC load breaking capacity

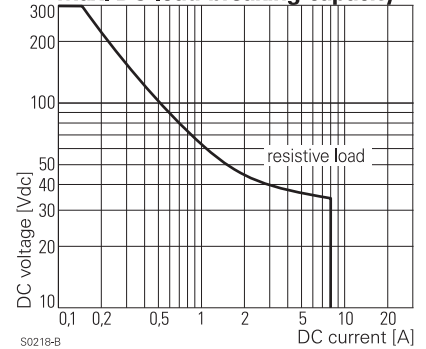

S0218-B

Electrical endurance

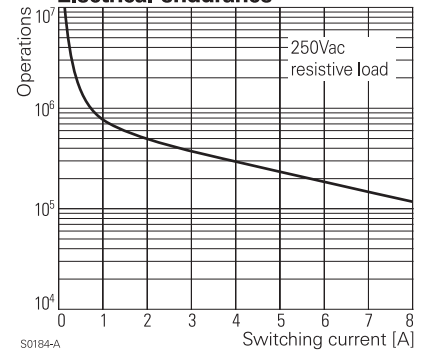

S0184-A

Coil operating range DC

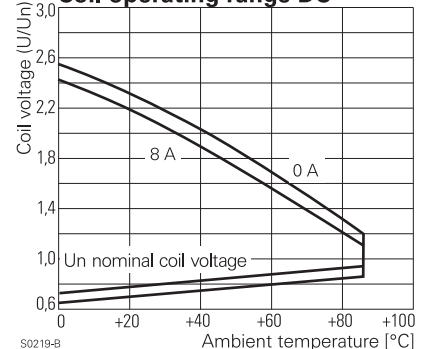

S0219-B

Miniature Power PCB Relay MSR

1 pole 8 A

Insulation		
Dielectric strength	coil-contacts	4000 V _{rms}
	open contact circuit	1000 V _{rms}
Clearance / creepage (standard)		8 / 8 mm
Insulation to IEC 60664		
Voltage rating		250 V
Pollution degree		3
Overvoltage category		III
Insulation to VDE 0110b (2/79)		
Insulation category / reference voltage		C / 250
Tracking resistance of relay base		CTI 250

Other data	
Flammability class according to UL 94	V-0
Ambient temperature	-40...+85 °C
Mechanical life	10x10 ⁶ operations
Max. switching rate at rated- / minimum load	6 min ⁻¹ / 20 s ⁻¹
Operate- / release time	6 / 2.5 ms
Category of protection (IEC 61810)	RT III - wash tight
Relay weight	11 g
Packaging unit	20 / 1000 pcs.

PCB layout / terminal assignment

View on solder pins
Dimensions in mm

1 C/O contact, 3.2 mm

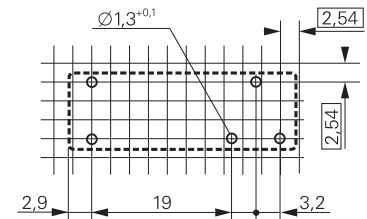

S0255-AA

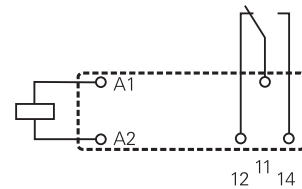

S0255-AB

1 N/O contact, 5 mm

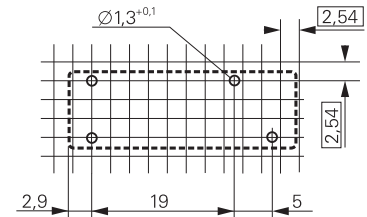

S0255-AH

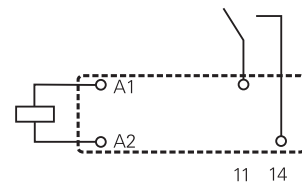

S0255-AI

Dimensions

Dimensions in mm

1 C/O contact, 3.2 mm

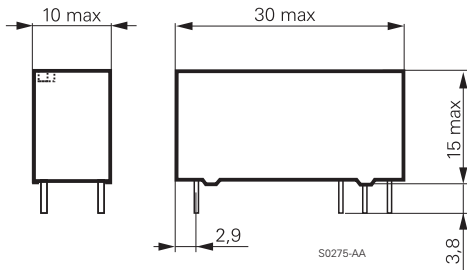

S0275-AA

1 N/O contact, 5 mm

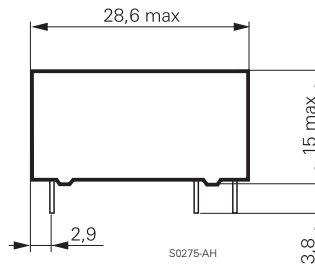

S0275-AH

Product key

V 2 3 0 6 1 - 1 - A

Type

Version

A 1 N/O contact **B** 1 C/O contact

Version

1 standard, wash tight

Coil

Coil code: please refer to coil versions table

Contact version

A standard

Contact material

3 AgSnO₂ **5** AgNi 0,15, gold flashed
4 AgCdO **6** AgCdO, gold plated

Contact configuration

01 1 C/O contact **02** 1 N/O contact

Other types on request

Miniature Power PCB Relay MSR

1 pole 8 A

Product key	Version	Contacts	Contact material	Coil	Part number
V23061-A1002-A302	standard	1 N/O contact	AgSnO	5 Vdc	0-1393222-4
V23061-A1002-A402	wash tight		AgCdO		0-1393222-5
V23061-A1002-A502			AgNi 0.15 gold fl.		0-1393222-6
V23061-A1003-A302			AgSnO	6 Vdc	0-1393222-9
V23061-A1003-A402			AgCdO		1-1393222-2
V23061-A1003-A502			AgNi 0.15 gold fl.		1-1393222-3
V23061-A1005-A302			AgSnO	12 Vdc	2-1393222-0
V23061-A1005-A402			AgCdO		2-1393222-3
V23061-A1005-A502			AgNi 0.15 gold fl.		2-1393222-7
V23061-A1005-A602			AgCdO gold pl.		2-1393222-8
V23061-A1007-A302			AgSnO	24Vdc	3-1393222-9
V23061-A1007-A402			AgCdO		4-1393222-2
V23061-A1007-A502			AgNi 0.15 gold fl.		4-1393222-6
V23061-A1007-A602			AgCdO gold pl.		4-1393222-7
V23061-A1009-A402			AgCdO	48 Vdc	5-1393222-6
V23061-A1009-A502			AgNi 0.15 gold fl.		5-1393222-7
V23061-A1009-A602			AgCdO gold pl.		5-1393222-8
V23061-A1010-A402			AgCdO	60 Vdc	6-1393222-1
V23061-A1010-A502			AgNi 0.15 gold fl.		6-1393222-2
V23061-A1010-A602			AgCdO gold pl.		6-1393222-3
V23061-B1002-A301		1 C/O contact	AgSnO	5 Vdc	7-1393222-2
V23061-B1002-A401			AgCdO		7-1393222-3
V23061-B1002-A501			AgNi 0.15 gold fl.		7-1393222-4
V23061-B1002-A601			AgCdO gold pl.		7-1393222-5
V23061-B1003-A401			AgCdO	6 Vdc	7-1393222-9
V23061-B1003-A501			AgNi 0.15 gold fl.		8-1393222-1
V23061-B1003-A601			AgCdO gold pl.		8-1393222-2
V23061-B1005-A301			AgSnO	12Vdc	9-1393222-1
V23061-B1005-A401			AgCdO		9-1393222-4
V23061-B1005-A501			AgNi 0.15 gold fl.		9-1393222-7
V23061-B1005-A601			AgCdO gold pl.		9-1393222-9
V23061-B1007-A301			AgSnO	24Vdc	1-1393223-7
V23061-B1007-A401			AgCdO		2-1393223-1
V23061-B1007-A501			AgNi 0.15 gold fl.		2-1393223-5
V23061-B1007-A601			AgCdO gold pl.		2-1393223-6
V23061-B1009-A301			AgSnO	48 Vdc	3-1393223-7
V23061-B1009-A401			AgCdO		3-1393223-8
V23061-B1009-A501			AgNi 0.15 gold fl.		3-1393223-9
V23061-B1009-A601			AgCdO gold pl.		4-1393223-0
V23061-B1010-A401			AgCdO	60 Vdc	4-1393223-2
V23061-B1010-A501			AgNi 0.15 gold fl.		4-1393223-3
V23061-B1010-A601			AgCdO gold pl.		4-1393223-4

Power PCB Relay RT1

1 pole 12 / 16 A, DC- or AC-coil



F0144-B

Features

- 1 C/O or 1 N/O contact
- Sensitive coil 400 mW
- 5 kV / 10 mm coil-contact, Protection class II (VDE 0700)
- Ambient temperature 85°C (DC-coil)
- Height 15.7 mm
- Sockets with PCB-type or screw-type terminals
- Gold plated contacts available

Applications

Boiler control, timers, garage door control, POS automation, interface modules



Technical data of approved types on request

Contact data

Configuration	1 C/O contact or 1 N/O contact	
Type of contact	single contact	
Rated current	12 A	16 A
Rated voltage / max.breaking voltage AC	250 Vac / 440 Vac	
Maximum breaking capacity AC	3000 VA	4000 VA
Make current (max. 4 s at duty cycle 10%)	25 A	30 A
Contact material	AgNi 90/10, AgNi 90/10 gold plated	

Contact ratings

Type	Load	Operations
RT314	1000 W, 250 Vac, incandescent lamps	1.2x10 ³
RT314	16 A, 250 Vac, cosφ=1, N/C contact	53x10 ³
RT314	10 A, 250 Vac, cosφ=0.6, C/O contact	2x10 ⁵
RT314	5 A / 2 A, 250 Vac, cosφ=1, tumble-drier motor, N/O contact	1.1x10 ⁶
RT314	0.26A _{peak} / 0.01 A, 230 Vac, cosφ=0.38, valve, N/O contact	7.6x10 ⁶

Coil data

Nominal voltage	DC coil	5...110 Vdc
	AC coil	24...230 Vac
Nominal coil power	DC coil	400 mW
	AC coil	0.75 VA
Operate category	2 / b	

Coil versions, DC-coil

Coil code	Nominal voltage Vdc	Pull-in voltage Vdc	Release voltage Vdc	Maximum voltage Vdc	Coil resistance Ω	Coil current mA
005	5	3.5	0.5	12.7	62±10%	80.0
006	6	4.2	0.6	15.3	90±10%	66.7
012	12	8.4	1.2	30.6	360±10%	33.3
024	24	16.8	2.4	61.2	1440±10%	16.7
048	48	33.6	4.8	122.4	5520±10%	8.7
060	60	42.0	6.0	153.0	7340±12%	8.1
110	110	77.0	11.0	280.5	26600±12%	4.1

All figures are given for coil without preenergization, at ambient temperature +20°C
Other coil voltages on request

Max. DC load breaking capacity

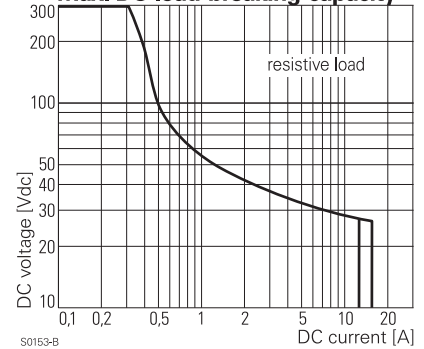

S0153-B

Electrical endurance

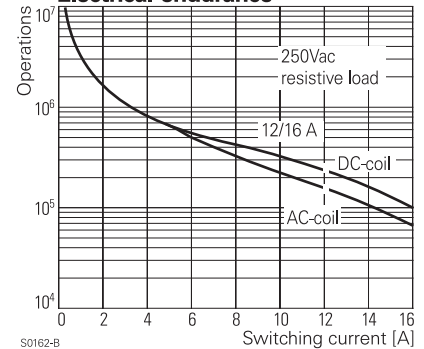

S0162-B

Coil operating range DC

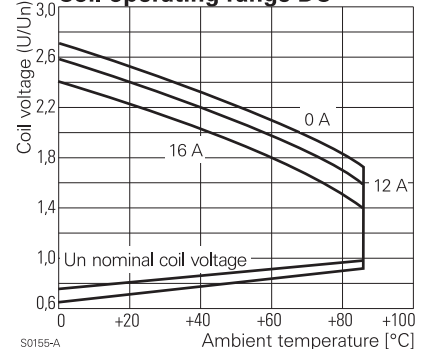

S0155-A

Power PCB Relay RT1

1 pole 12 / 16 A, DC- or AC-coil

Coil versions, AC-coil

Coil code	Nominal voltage Vac	Pull-in voltage Vac	Release voltage Vac	Maximum voltage Vac	Coil resistance Ω	Coil current mA
524	24	18.0	3.6	36.0	350 ± 10%	31.6
615	115	86.3	17.3	172.5	8100 ± 15%	6.6
730	230	172.5	34.5	345.0	32500 ± 15%	3.2

All figures are given for coil without preenergization, at ambient temperature +20°C

Insulation

Dielectric strength	coil-contacts	5000 V _{rms}
	open contact circuit	1000 V _{rms}
Clearance / creepage		10 / 10 mm
Insulation to IEC 60664		
	Voltage rating	250 V
	Pollution degree	3
	Overvoltage category	III
Insulation to VDE 0110b (2/79)		
	Insulation category / reference voltage	C / 250
Tracking resistance of relay base		CTI 250

Other data

Flammability class according to UL 94	V-0
Coil insulation system according to UL 1446	Class F
Ambient temperature	DC-coil -40...+85 °C AC-coil -40...+70 °C
Mechanical life	DC-coil >30x10 ⁶ operations AC-coil >10x10 ⁶ operations
Max. switching rate at rated- / minimum load	6 min ⁻¹ / 1200 min ⁻¹
Operate- / release time DC-coil	typ. 7 / 3 ms
Bounce time N/O contact/N/C contact	typ. 1 / 3 ms
Vibration resistance N/O / N/C contact	20 / 5 g, 30...500 Hz
Shock resistance (destruction)	100 g
Category of protection (IEC 61810)	RT II, RT III
Relay weight	14 g
Packaging unit	20 / 500 pcs.
Accessories	see accessories RT

Coil operating range AC

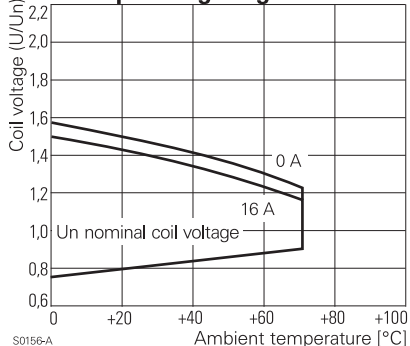

S0156-A

Dimensions

Dimensions in mm

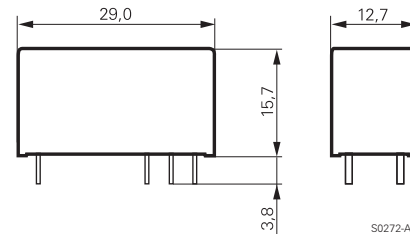

S0272-AB

PCB layout / terminal assignment

View on solder pins
Dimensions in mm

12 A, pinning 3.5 mm

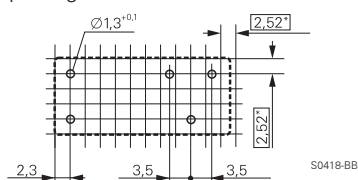

S0418-BB

12 A, pinning 5 mm

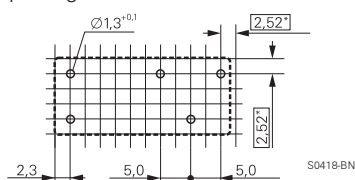

S0418-BN

16 A, pinning 5 mm

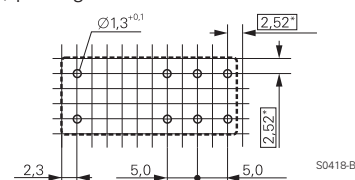

S0418-BA

1 C/O contact

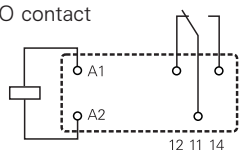

S0163-BG

1 C/O contact

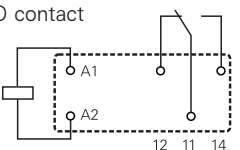

S0163-BC

1 C/O contact

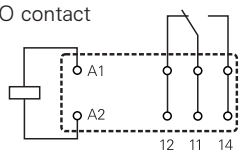

S0163-BE

1 N/O contact

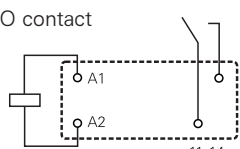

S0163-BH

1 N/O contact

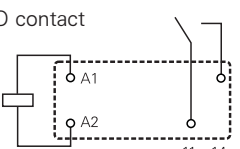

S0163-BD

1 N/O contact

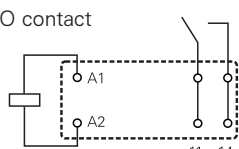

S0163-BF

*) With the recommended PCB hole sizes a grid pattern from 2.5 mm to 2.54 mm can be used.

Power PCB Relay RT1

1 pole 12 / 16 A, DC- or AC-coil

Product key

R	T						
----------	----------	--	--	--	--	--	--

Type

Version

- | | | | |
|----------|---|----------|----------------------------------|
| 1 | 12 A, pinning 3.5 mm, flux proof | B | 12 A, pinning 3.5 mm, wash tight |
| 2 | 12 A, pinning 5 mm, flux proof *) | | |
| 3 | 16 A, pinning 5 mm, flux proof | D | 16 A, pinning 5 mm, wash tight |

Contacts

- | | | | |
|----------|---------------|----------|---------------|
| 1 | 1 C/O contact | 3 | 1 N/O contact |
|----------|---------------|----------|---------------|

Contact material

- | | | | |
|----------|------------|----------|---|
| 4 | AgNi 90/10 | 5 | AgNi 90/10 gold plated (for type RT31.) |
|----------|------------|----------|---|

Coil

Coil code: please refer to coil versions table

Preferred types in bold print

*) Washable version on request

Product key	Version	Contacts	Cont. material	Coil	Coil	Part number
RT114005	12 A	1 C/O contact	AgNi 90/10	DC-coil	5 Vdc	0-1393239-7
RT114006	pinning 3.5 mm				6 Vdc	0-1393239-8
RT114012	flux proof				12 Vdc	0-1419108-1
RT114024					24 Vdc	1-1393239-3
RT114048					48 Vdc	1-1393239-4
RT114110					110 Vdc	1-1393239-6
RT114524				AC-coil	24 Vac	1-1393239-7
RT114615					115 Vac	1-1393239-8
RT114730					230 Vac	1-1393239-9
RT134012		1 N/O contact		DC-coil	12 Vdc	2-1393239-6
RT134024					24 Vdc	3-1393239-0
RT214012	12 A, pinning 5mm	1 C/O contact			12 Vdc	5-1393239-4
RT214024	flux proof				24 Vdc	5-1393239-5
RT314005	16 A				5 Vdc	9-1393239-1
RT314006	pinning 5 mm				6 Vdc	9-1393239-3
RT314012	flux proof				12 Vdc	9-1393239-5
RT314024					24 Vdc	9-1393239-8
RT314048					48 Vdc	0-1393240-1
RT314060					60 Vdc	0-1393240-2
RT314110					110 Vdc	0-1393240-3
RT314524				AC-coil	24 Vac	0-1393240-4
RT314615					115 Vac	0-1393240-6
RT314730					230 Vac	0-1393240-7
RT315012			AgNi 90/10 gold plated	DC-coil	12 Vdc	1-1393240-1
RT315024					24 Vdc	1-1393240-4
RT315730				AC-coil	230 Vac	1-1419108-1
RT334012		1 N/O contact	AgNi 90/10	DC-coil	12 Vdc	4-1393240-5
RT334024					24 Vdc	4-1393240-8
RT334048					48 Vdc	5-1393240-0
RTB14005	12 A	1 C/O contact			5 Vdc	1-1393238-2
RTB14012	pinning 3.5 mm				12 Vdc	1-1393238-5
RTB14024	wash tight				24 Vdc	1-1393238-9
RTB14048					48 Vdc	2-1393238-1
RTD14005	16 A				5 Vdc	5-1393238-9
RTD14006	pinning 5 mm				6 Vdc	6-1393238-0
RTD14012	wash tight				12 Vdc	6-1393238-2
RTD14015					15 Vdc	6-1393238-4
RTD14024					24 Vdc	6-1393238-8
RTD14048					48 Vdc	6-1393238-9
RTD34005		1 N/O contact			5 Vdc	8-1393238-3
RTD34012					12 Vdc	3-1419108-5
RTD34024					24 Vdc	3-1419108-8

Power PCB Relay RT1 bistable

1 pole 16 A, polarized bistable version



Features

- 1 C/O contact
- Bistable with 1 or 2 coils
- 5 kV / 10 mm coil-contact
- Height 15.7 mm
- Cadmium-free contacts
- Protection class II (VDE 0700)

Applications

Battery powered equipment or applications with "memory function"

F0176-B



Technical data of approved types on request

Contact data

Configuration	1 C/O contact
Type of contact	single contact
Rated current	16 A
Rated voltage / max. breaking voltage	250 Vac / 440 Vac
Rated breaking capacity	4000 VA
Make current (max. 4 s at duty cycle 10%)	30 A
Contact material	AgNi 90/10

Coil data

	1 coil	2 coils
Nominal voltage	5...24 Vdc	
Nominal coil power	typ. 400 mW	typ. 600 mW
Minimum energization time	30 ms	
Information on reduced pulse duration with higher energization voltages on demand		
Max. energization for version with 2 coils	1 min at <10% duty cycle	
Reset voltage max.	120 % U_{nom}	150 % U_{nom}

Coil versions, bistable

Coil code	Nominal voltage Vdc	Pull-in voltage Vdc	Reset voltage Vdc	Coil resistance Ω	Coil current mA
bistable, 1 coil					
A05	5	3.5	3.5	$62 \pm 10\%$	80.0
A06	6	4.2	4.2	$90 \pm 10\%$	66.7
A12	12	8.4	8.4	$360 \pm 10\%$	33.3
A24	24	16.8	16.8	$1440 \pm 10\%$	16.7
bistable, 2 coils					
F05	5	3.5	3.5	$42 \pm 10\%$	120.0
F06	6	4.2	4.2	$55 \pm 10\%$	110.0
F12	12	8.4	8.4	$240 \pm 10\%$	50.0
F24	24	16.8	16.8	$886 \pm 10\%$	27.0

All figures are given for coil without preenergization, at ambient temperature +20°C

Other coil voltages on request

Coils - operation

Version	1 coil		2 coils		
Coil terminals	A1	A2	A1	A3	A2
Pull-in	+	-		+	-
Reset	-	+	-	+	

Contact position not defined at delivery

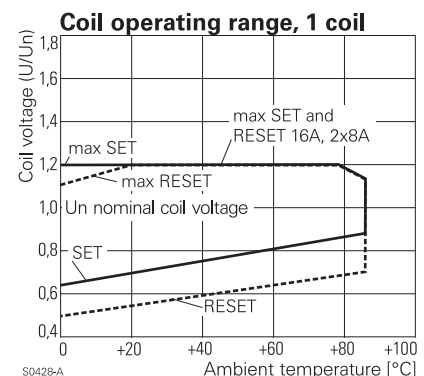
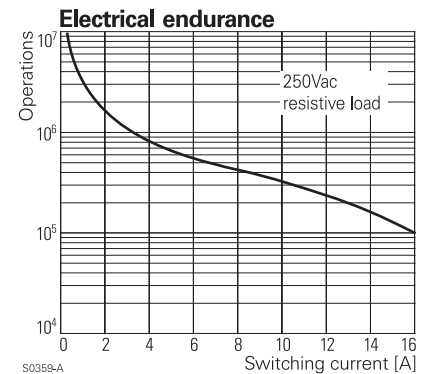
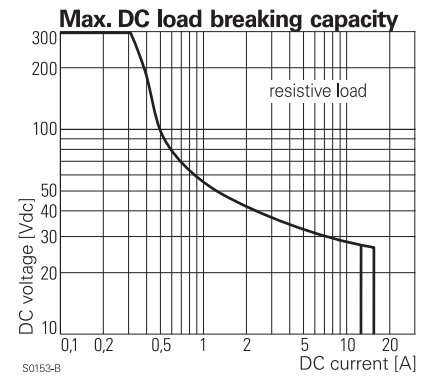

Power PCB Relay RT1 bistable

1 pole 16 A, polarized bistable version

Insulation		
Dielectric strength	coil-contacts	5000 V _{rms}
	open contact circuit	1000 V _{rms}
Clearance / creepage		10 / 10 mm
Insulation to IEC 60664		
	Voltage rating	250 V
	Pollution degree	3
	Overvoltage category	III
Insulation to VDE 0110b (2/79)		
	Insulation category / reference voltage	C / 250
Tracking resistance of relay base		CTI 250

Other data		
Flammability class according to UL 94		V-0
Coil insulation system according to UL 1446		Class F
Ambient temperature		-40...+85 °C
Mechanical life		5x10 ⁶ operations
Max. switching rate at rated- / minimum load		6 min ⁻¹ / 600 min ⁻¹
Operate- / release time		typ. 5 / 4 ms
Bounce time N/O contact/N/C contact		typ. 1 / 3 ms
Vibration resistance / shock resistance		
	opening N/C contact	3 / 5 g
	closing the N/O contact	6 / 15 g
Shock resistance (destruction)		100 g
Category of protection (IEC 61810)		RT II - flux proof
Relay weight		13 g
Packaging unit	1 coil	20 / 500 pcs.
	2 coils	25 / 100 pcs.
Accessories	see accessories RT	

Dimensions

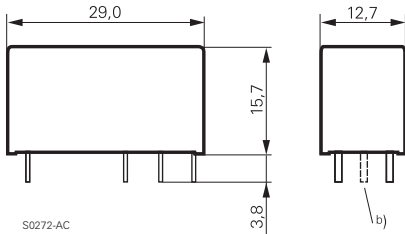

- a) Indicated contact position during or after coil energization with reset voltage.
 b) for 2 coil version only

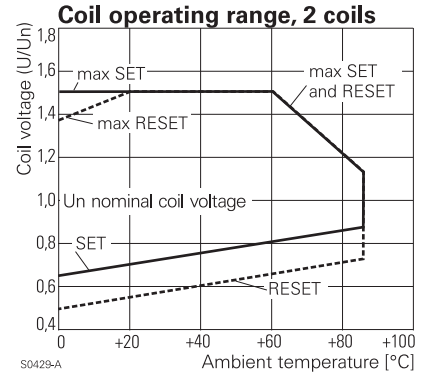

PCB layout / terminal assignment

View on solder pins
 Dimensions in mm

16 A, pinning 5 mm

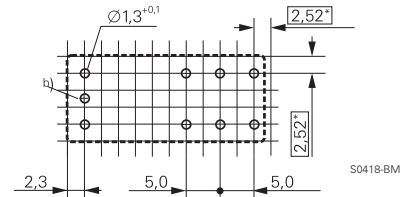

*) With the recommended PCB hole sizes a grid pattern from 2.5 mm to 2.54 mm can be used.

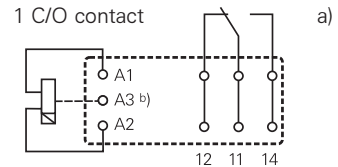

Product key

Type					
Version					
Contacts					
Contact material					
Coil					

Coil code: please refer to coil versions table, preferred types in bold print

Product key	Version	Contacts	Cont. material	Coil	Coil	Part number
RT314A12	16 A	1 C/O contact	AgNi 90/10	bistable	12 Vdc	8-1393239-0
RT314A24	pinning 5 mm			1 coil	24 Vdc	8-1393239-1
RT314F12	flux proof			bistable	12 Vdc	8-1393239-7
RT314F24				2 coils	24 Vdc	8-1393239-8

Power PCB Relay RT1 sensitive

1 pole 10 A, highly sensitive version



F0145-B

Features

- 1 C/O or 1 N/O contact
- Sensitive coil 250 mW
- 5 kV / 10 mm coil-contact
- Protection class II (VDE 0700)
- Ambient temperature 85°C at rated load
- Height 15.7 mm
- Sockets with PCB-type or screw-type terminals

Applications

Domestic appliances, heating control



Technical data of approved types on request

Contact data

Configuration	1 C/O contact or 1 N/O contact
Type of contact	single contact
Rated current	10 A
Rated voltage / max.breaking voltage AC	250 Vac / 440 Vac
Maximum breaking capacity AC	2500 VA
Make current (max. 4 s at duty cycle 10%)	15 A
Contact material	AgNi 90/10

Contact ratings

Type	Load	Operations
RT174	8 A, 250 Vac	4.3x10 ⁵
RT174	370 W, 230 Vac, compressor, N/O contact	>3.3x10 ⁵
RT174	550 W, 250 Vac, incandescent lamps, N/O contact	1.9x10 ⁵
RT174	0.8A _{peak} / 0.08 A, 230 Vac, cosφ=0.23, contactor 190 / 90 VA, N/O contact	>8.8x10 ⁶

Coil data

Nominal voltage	5...60 Vdc
Nominal coil power	250 mW
Operate category	2 / b

Coil versions, sensitive DC-coil

Coil code	Nominal voltage Vdc	Pull-in voltage Vdc	Release voltage Vdc	Maximum voltage Vdc	Coil resistance Ω	Coil current mA
005	5	3.7	0.5	15.0	100±10%	50.0
006	6	4.5	0.6	18.0	144±10%	41.7
012	12	9.0	1.2	36.0	576±10%	20.8
024	24	18.0	2.4	72.0	2304±10%	10.4
048	48	36.0	4.8	144.0	9216±10%	5.4
060	60	45.0	6.0	180.0	12857±12%	4.7

All figures are given for coil without preenergization, at ambient temperature +20°C

Other coil voltages on request

Max. DC load breaking capacity

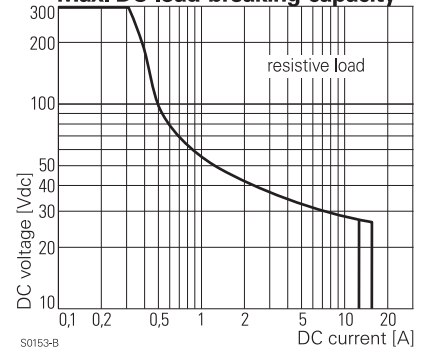

S0153-B

Electrical endurance

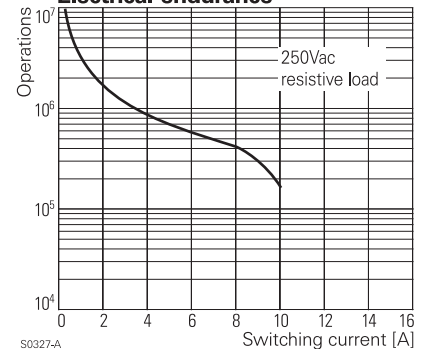

S0327-A

Coil operating range DC

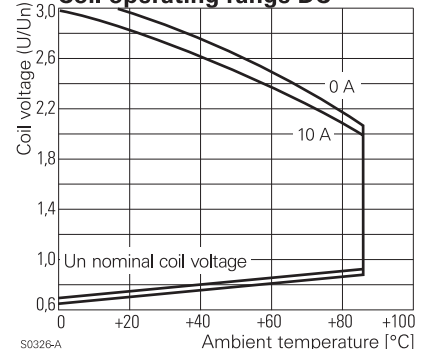

S0326-A

Power PCB Relay RT1 sensitive

1 pole 10 A, highly sensitive version

Insulation		
Dielectric strength	coil-contacts	5000 V _{rms}
	open contact circuit	1000 V _{rms}
Clearance / creepage		10 / 10 mm
Insulation to IEC 60664		
Voltage rating		250 V
Pollution degree		3
Overvoltage category		III
Insulation to VDE 0110b (2/79)		
Insulation category / reference voltage		C / 250

Other data	
Flammability class according to UL 94	V-0
Coil insulation system according to UL 1446	Class F
Ambient temperature	-40...+85 °C
Mechanical life	30x10 ⁶ operations
Max. switching rate at rated- / minimum load	50 min ⁻¹ / 1200 min ⁻¹
Operate- / release time	typ. 7 / 3 ms
Bounce time N/O contact/N/C contact	typ. 2 / 4 ms
Vibration resistance	5 g, 30...150 Hz
Shock resistance (destruction)	100 g
Category of protection (IEC 61810)	RT II - flux proof, RT III - wash tight
Relay weight	14 g
Packaging unit	20 / 500 pcs.
Accessories	see accessories RT

PCB layout / terminal assignment

View on solder pins
Dimensions in mm

10 A, pinning 3.5 mm

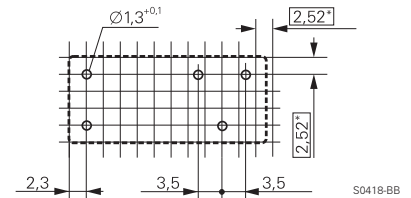

*) With the recommended PCB hole sizes a grid pattern from 2.5 mm to 2.54 mm can be used.

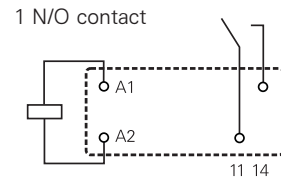
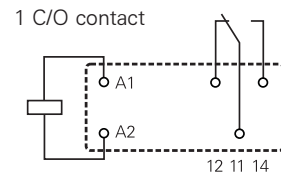

Dimensions

Dimensions in mm

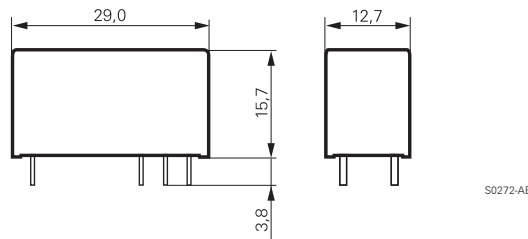

Product key

Type

Version

1 10 A, pinning 3.5 mm, flux proof

B 10 A, pinning 3.5 mm, wash tight

Contacts

7 1 C/O contact

8 1 N/O contact

Contact material

4 AgNi 90/10

Coil

Coil code: please refer to coil versions table

Preferred types in bold print

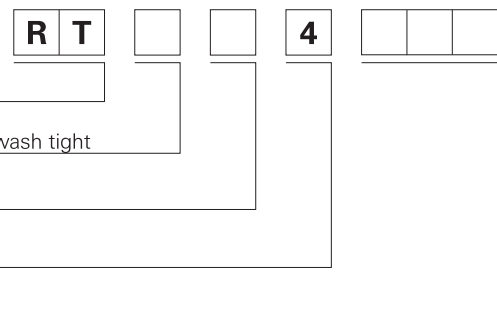

Product key	Version	Contacts	Contact material	Coil	Part number
RT174005	10 A	1 C/O contact	AgNi 90/10	5 Vdc	3-1393239-6
RT174006	pinning 3.5 mm			6 Vdc	3-1393239-7
RT174012	flux proof			12 Vdc	3-1393239-8
RT174024				24 Vdc	3-1393239-9
RTB74012	10 A, 3.5mm			12 Vdc	4-1393238-4
RTB74024	wash tight			24 Vdc	4-1393238-6

Power PCB Relay RT1 Inrush

1 pole 16 A, for inrush peak currents up to 80 A



Features

- 1 N/O contact
- Sensitive coil 400 mW
- 5 kV / 10 mm coil-contact
- Protection class II (VDE 0700)
- Ambient temperature 85°C
- Height 15.7 mm
- Sockets with PCB-type or screw-type terminals

Applications

Domestic appliances, heating control, lighting control

F0177-B



Technical data of approved types on request

Contact data

Configuration	1 N/O contact
Type of contact	single contact
Rated current	16 A
Rated voltage / max.breaking voltage AC	250 Vac / 440 Vac
Maximum breaking capacity AC	4000 VA
Make current (max. 4 s at duty cycle 10%)	30 A
peak inrush current (20 ms)	80 A
Contact material	AgNi 90/10, AgSnO ₂

Contact ratings

Type	Load	Operations
RT33K	1000 W, 250 Vac, incandescent lamps	typ. 9x10 ⁴
RT33L	1000 W, 250 Vac, incandescent lamps	typ. 8x10 ⁴
RT33L	compressor, 230 Vac, I _{in} ≤21A _{peak} , I _{off} =3.5 A, cosφ=0.5	typ. 2.3x10 ⁵

Coil data

Nominal voltage	5...110 Vdc
Nominal coil power	400 mW
Operate category	2 / b

Coil versions, DC-coil

Coil code	Nominal voltage Vdc	Pull-in voltage Vdc	Release voltage Vdc	Maximum voltage Vdc	Coil resistance Ω	Coil current mA
012	12	8.4	1.2	30.6	360±10%	33.3
024	24	16.8	2.4	61.2	1440±10%	16.7
048	48	33.6	4.8	122.4	5520±10%	8.7
060	60	42.0	6.0	153.0	7340±12%	8.1

All figures are given for coil without preenergization, at ambient temperature +20°C
Other coil voltages on request

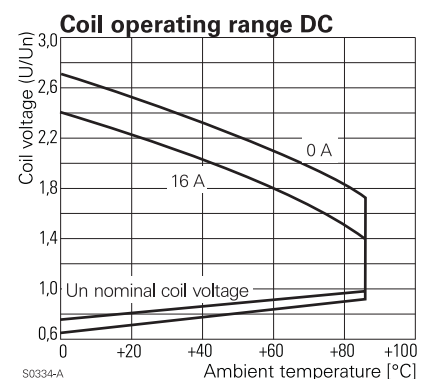
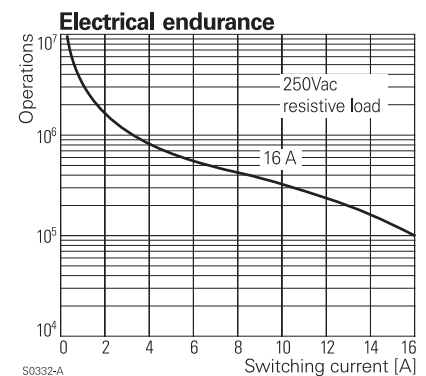
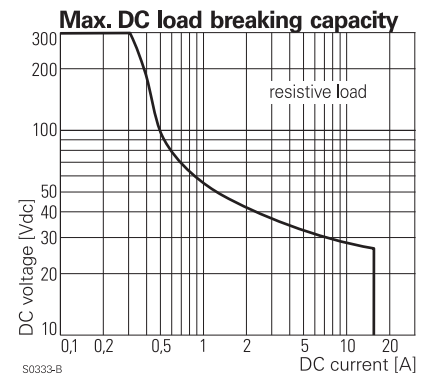

Power PCB Relay RT1 Inrush

1 pole 16 A, for inrush peak currents up to 80 A

Insulation		
Dielectric strength	coil-contacts	5000 V _{rms}
	open contact circuit	1000 V _{rms}
Clearance / creepage		10 / 10 mm
Insulation to IEC 60664		
	Voltage rating	250 V
	Pollution degree	3
	Overvoltage category	III
Insulation to VDE 0110b (2/79)		
	Insulation category / reference voltage	C / 250

Other data	
Flammability class according to UL 94	V-0
Coil insulation system according to UL 1446	Class F
Ambient temperature	-40...+85 °C
Mechanical life	30x10 ⁶ operations
Max. switching rate at rated- / minimum load	6 min ⁻¹ / 1200 min ⁻¹
Operate- / release time	typ. 8 / 3 ms
Bounce time	typ. 2 ms
Vibration resistance	20 g, 30...500 Hz
Shock resistance (destruction)	100 g
Category of protection (IEC 61810)	RT II - flux proof
Relay weight	14 g
Packaging unit	20 / 500 pcs.
Accessories	see accessories RT

PCB layout / terminal assignment

View on solder pins
Dimensions in mm

16 A, pinning 5 mm

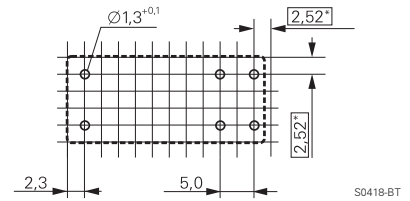

*) With the recommended PCB hole sizes a grid pattern from 2.5 mm to 2.54 mm can be used.

1 N/O contact

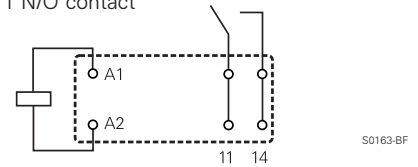

Dimensions

Dimensions in mm

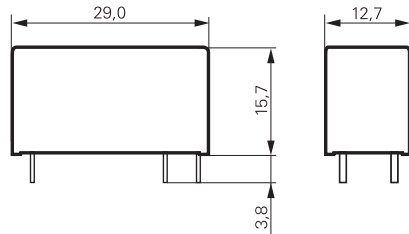

Product key

Type

Version

3 16 A, pinning 5 mm, flux proof

Contacts

3 1 N/O contact

Contact material

K AgNi 90/10

L AgSnO₂

Coil

Coil code: please refer to coil versions table, preferred types in bold print

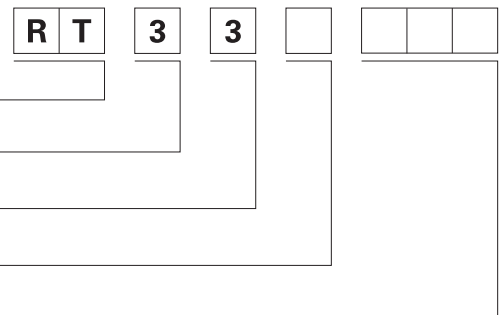

Product key	Version	Contacts	Contact material	Coil	Part number
RT33K012	16 A	1 N/O contact	AgNi 90/10	12 Vdc	2-1393240-3
RT33K024	pinning 5 mm			24 Vdc	2-1393240-4
RT33K048	flux proof			48 Vdc	2-1393240-5
RT33L012			AgSnO	12 Vdc	3-1393240-3
RT33L024				24 Vdc	3-1393240-5
RT33L048				48 Vdc	3-1393240-6

Power PCB Relay 429 03 Inrush

1 pole 10 A, for inrush peak currents up to 80 A



F0247-A

Features

- 1 N/O contact (W prerun contact + AgSnO₂)
- 80 A / 20 ms inrush peak current
- 4 kV / 8 mm coil-contact, protection class II (VDE 0700)
- Sensitive coil 480mW
- Height 15,0 mm

Applications

Lighting systems, movement sensors, filament lamp loads, halogen bulbs and motors



Technical data of approved types on request

Contact data

Configuration	1 N/O contact
Type of contact	single contact
Rated current	10 A
Rated voltage / max.breaking voltage AC	250 Vac / 400 Vac
Make current (max. 4 s at duty cycle 10%)	16 A
peak inrush current (20 ms)	80 A
Contact material	W (prerun contact) + AgSnO ₂

Contact ratings

Type	Load	Operations	Standard
429 03	10 A, 250 Vac, resistive	5x10 ⁴	Standard
429 03	2500 W, incandescent lamps	3x10 ⁴	
429 03	1300 W, fluorescent lamps, 140 µF	3x10 ⁴	
429 03	1000 W, Dulux lamps, 140 µF	3x10 ⁴	

Coil data

Nominal voltage	6...60 Vdc
Nominal coil power	480 mW
Operate category	1 / b

Coil versions

Coil code	Nominal voltage Vdc	Pull-in voltage Vdc	Release voltage Vdc	Maximum voltage Vdc	Coil resistance Ω	Coil current mA
16	6	4.2	0.4	12.0	80±10%	75.0
13	12	8.4	0.9	24.0	300±10%	40.0
08	24	16.8	1.8	48.0	1200±10%	20.0
05	48	33.6	3.6	96.0	4825±10%	10.0
03	60	42.0	4.5	120.0	7500±10%	8.0

All figures are given for coil without preenergization, at ambient temperature +20°C
Other coil voltages on request

Coil operating range DC

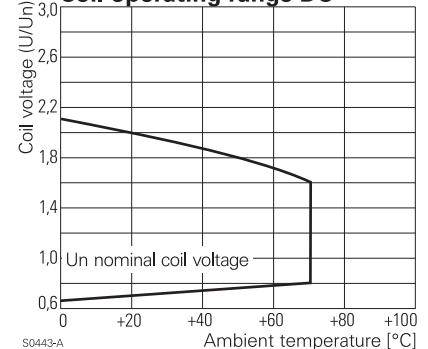

S0443-A

Power PCB Relay 429 03 Inrush

1 pole 10 A, for inrush peak currents up to 80 A

Insulation

Dielectric strength	coil-contacts	4000 V _{rms}
	open contact circuit	1000 V _{rms}
Clearance / creepage		8 / 8 mm
Insulation to IEC 60664		
Voltage rating		250 V
Pollution degree		3
Overvoltage category		III
Insulation to VDE 0110b (2/79)		
Insulation category / reference voltage		C / 250
Tracking resistance of relay base		PTI 250

Dimensions

Dimensions in mm

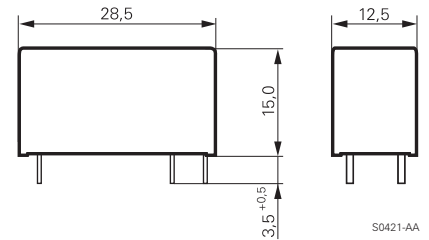

S0421-AA

Other data

Flammability class according to UL 94	V-0
Ambient temperature	-40...+70 °C
Mechanical life	>5x10 ⁶ operations
Max. switching rate at rated- / minimum load	10 min ⁻¹ / 300 min ⁻¹
Operate- / release time	typ. 6 / 4 ms
Bounce time N/O contact	typ. 3 ms
Shock resistance (destruction)	100 g
Category of protection (IEC 61810)	RT II - flux proof
Relay weight	10 g
Packaging unit	50 / 400 pcs.

PCB layout / terminal assignment

View on solder pins
Dimensions in mm

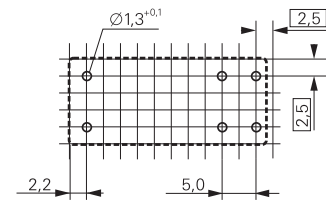

S0420-AA

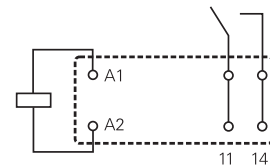

S0420-AA

Product key



Type

Coil

Coil code: Please refer to coil versions table, preferred types in bold print

Contacts

12 W (prerun contact) + AgSnO₂

Version

00 Standard

Other types on request

Product key	Version	Contacts	Contact material	Coil	Part number
0429 03 1312 00	10A	1 N/O contact	W prerun	12Vdc	7-1415429-4
0429 03 0812 00	flux proof		AgSnO	24Vdc	7-1415429-0
0429 03 0512 00				48Vdc	6-1415429-7

Power PCB Relay RTH 105°C sensitive

1 pole 10 A, high-temperature version



Features

- 1 N/O contact
- Sensitive coil 250 mW
- 5 kV / 10 mm coil-contact
- Protection class II (VDE 0700)
- Ambient temperature 105°C at rated load
- Height 15.7 mm

Applications

Domestic appliances, heating control

F0178-C



Technical data of approved types on request

Contact data

Configuration	1 N/O contact
Type of contact	single contact
Rated current	10 A
Rated voltage / max.breaking voltage AC	250 Vac / 440 Vac
Maximum breaking capacity AC	2500 VA
Make current (max. 4 s at duty cycle 10%)	15 A
Contact material	AgNi 90/10

Contact ratings

Type	Load	Operations
RTH84	12 A, 250 Vac, 105 °C, dry switching	>5x10 ⁵
RTH84	10 A, 250 Vac, cyclical heat 105/40 °C	2x10 ⁵
RTH84	10 A, 250 Vac, 105 °C	1.5x10 ⁵

Coil data

Nominal voltage	5...60 Vdc
Nominal coil power	250 mW
Operate category	2 / b

Coil versions, sensitive DC-coil

Coil code	Nominal voltage Vdc	Pull-in voltage Vdc	Release voltage Vdc	Maximum voltage Vdc	Coil resistance Ω	Coil current mA
012	12	9.0	1.2	36.0	576±10%	20.8
024	24	18.0	2.4	72.0	2304±10%	10.4

All figures are given for coil without preenergization, at ambient temperature +20°C
Other coil voltages on request

Max. DC load breaking capacity

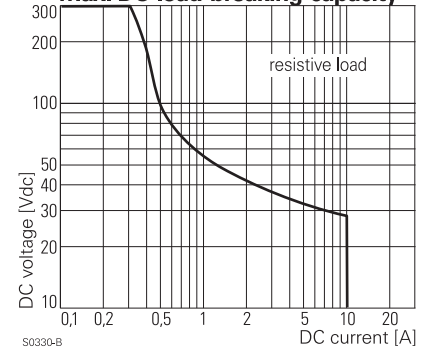

Electrical endurance

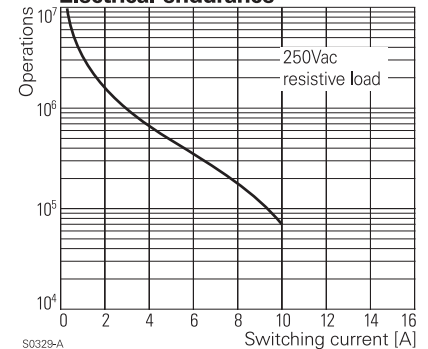

Coil operating range DC

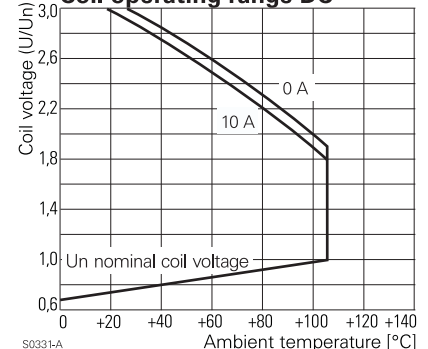

Power PCB Relay RTH 105°C sensitive

1 pole 10 A, high-temperature version

Insulation		
Dielectric strength	coil-contacts	5000 V _{rms}
	open contact circuit	1000 V _{rms}
Clearance / creepage		10 / 10 mm
Insulation to IEC 60664		
Voltage rating		250 V
Pollution degree		3
Overvoltage category		III
Insulation to VDE 0110b (2/79)		
Insulation category / reference voltage		C / 250

Other data	
Flammability class according to UL 94	V-0
Coil insulation system according to UL 1446	Class F
Ambient temperature	-40...+105 °C
Mechanical life	10x10 ⁶ operations
Max. switching rate at rated- / minimum load	6 min ⁻¹ / 1200 min ⁻¹
Operate- / release time	typ. 8 / 3 ms
Bounce time	typ. 2 ms
Vibration resistance	5 g, 30...150 Hz
Shock resistance (destruction)	100 g
Category of protection (IEC 61810)	RT II - flux proof
Relay weight	14 g
Packaging unit	20 / 500 pcs.

Dimensions

Dimensions in mm

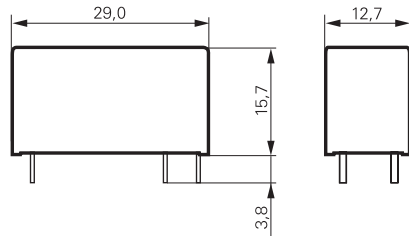

S0272-AE

PCB layout / terminal assignment

View on solder pins
Dimensions in mm

10 A, pinning 5 mm

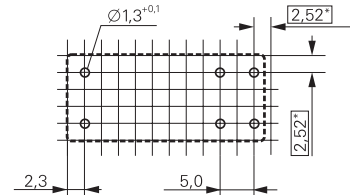

S0418-BT

*) With the recommended PCB hole sizes a grid pattern from 2.5 mm to 2.54 mm can be used.

1 N/O contact

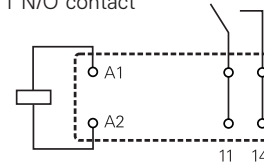

S0163-BF

Product key

Type

Version

H 10 A, pinning 5 mm, 105°C

Contacts

8 1 N/O contact

Contact material

4 AgNi 90/10

Coil

Coil code: please refer to coil versions table



Product key	Version	Contacts	Contact material	Coil	Part number
RTH84012	10 A, 5 mm	1 N/O contact	AgNi 90/10	12 Vdc	9-1393238-2
RTH84024	105°C, flux proof			24 Vdc	9-1393238-3

Power PCB Relay RTH 105°C 16A

1 pole 16 A, high-temperature version



Features

- 1 C/O or 1 N/O contact
- Sensitive coil 400 mW
- 5 kV / 10 mm coil-contact
- Protection class II (VDE 0700)
- Ambient temperature 105°C at rated load
- Height 15.7 mm

Applications

Oven control, cooking plate control

F0220-C



Technical data of approved types on request

Contact data

Configuration	1 C/O contact or 1 N/O contact
Type of contact	single contact
Rated current	16 A ¹⁾
Rated voltage / max.breaking voltage AC	250 Vac / 440 Vac
Maximum breaking capacity AC	4000 VA
Make current (max. 4 s at duty cycle 10%)	30 A
Contact material	AgNi 90/10

Contact ratings

Type	Load	Operations	standard
RTH34	10 A, 250 Vac, 105 °C	1.5x10 ⁵	EN 61810/T1
RTH34	16 A, 250 Vac, 105 °C	2x10 ⁴	
RTHH4	10 A, 250 Vac, 105 °C	typ. 3x10 ⁵	
RTHH4	16 A ON / 8 A OFF, 250 Vac, 105 °C	typ. 2.5x10 ⁵	

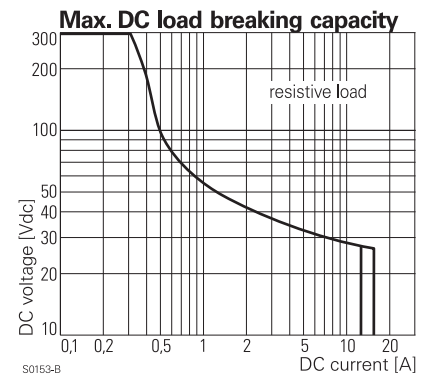

Coil data

Nominal voltage	5...60 Vdc
Nominal coil power	400 mW ¹⁾
Operate category	90 - 110 % U _{nom}

Coil versions, DC-coil

Coil code	Nominal voltage Vdc	Pull-in voltage Vdc	Release voltage Vdc	Maximum voltage Vdc	Coil resistance Ω	Coil current mA
009	9	6.3	0.9	22.9	203±10%	44.3
012	12	8.4	1.2	30.6	360±10%	33.3
024	24	16.8	2.4	61.2	1440±10%	16.7

All figures are given for coil without preenergization, at ambient temperature +20°C
Other coil voltages on request

¹⁾ Continuous thermal load > 10 A at 105°C requires reduction of coil power to 64% of nominal power after 100 ms

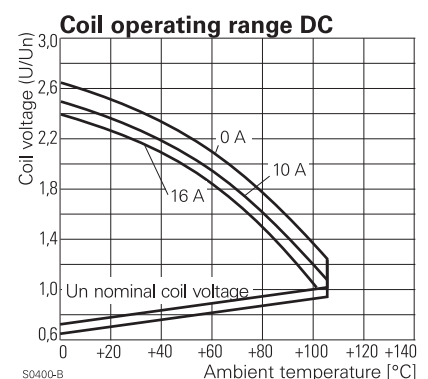

Power PCB Relay RTH 105°C 16A

1 pole 16 A, high-temperature version

Insulation		
Dielectric strength	coil-contacts	5000 V _{rms}
	open contact circuit	1000 V _{rms}
Clearance / creepage		10 / 10 mm
Insulation to IEC 60664		
	Voltage rating	250 V
	Pollution degree	3
	Overvoltage category	III
Insulation to VDE 0110b (2/79)		
	Insulation category / reference voltage	C / 250

Other data	
Flammability class according to UL 94	V-0
Coil insulation system according to UL 1446	Class F
Ambient temperature	-40...+105 °C
Mechanical life	10x10 ⁶ operations
Max. switching rate at rated- / minimum load	6 min ⁻¹ / 1200 min ⁻¹
Operate- / release time	typ. 7 / 3 ms
Bounce time N/O contact / N/C contact	typ. 1 / 3 ms
Vibration resistance N/O / N/C contact	20 / 5 g, 30...150 Hz
Shock resistance (destruction)	100 g
Category of protection (IEC 61810)	RT II - flux proof
Relay weight	14 g

PCB layout / terminal assignment

View on solder pins
Dimensions in mm

16 A, pinning 5 mm

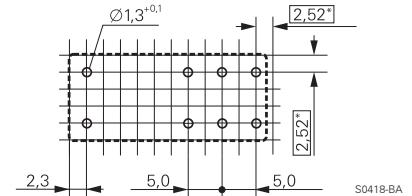

*) With the recommended PCB hole sizes a grid pattern from 2.5 mm to 2.54 mm can be used.

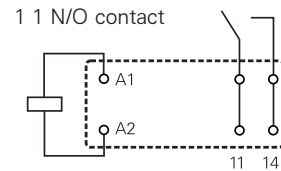
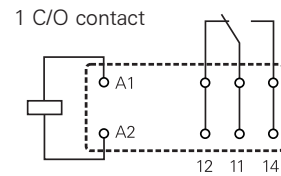

Dimensions

Dimensions in mm

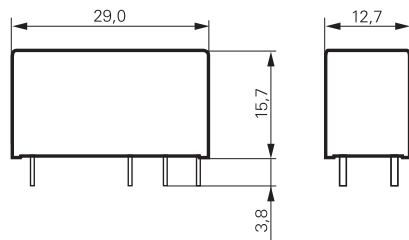

Product key

Type

Version

H 16 A, pinning 5 mm, 105°C

Contacts

1 1 C/O contact

3 1 N/O contact

H 1 N/O contact "High Performance"

Contact material

4 AgNi 90/10

Coil

Coil code: please refer to coil versions table

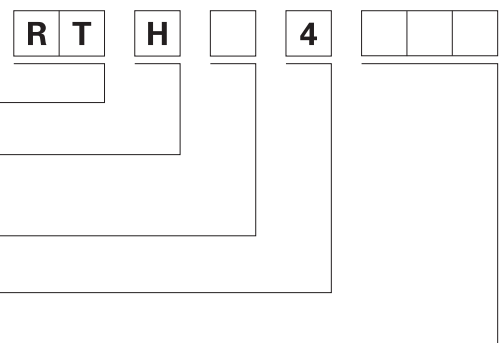

Product key	Version	Contacts	Contact material	Coil	Part number
RTH14012	16 A	1 C/O contact	AgNi 90/10	12 Vdc	8-1415006-1
RTH34012	pinning 5mm	1 N/O contact		12 Vdc	9-1415006-1
RTHH4009	flux proof	1 N/O high performance		9 Vdc	7-1415077-1
RTHH4012	105°C			12 Vdc	8-1415047-1

Power PCB Relay RP II/1

1 pole 8 / 12 / 16 A



F0146-B

Features

- 1 C/O or 1 N/O contact
- 4 kV / 8 mm coil-contact
- Pinning 3.5 or 5 mm (8 / 12 A) and 5 mm (16 A)
- PCB-sockets

Applications

Power supplies, domestic appliances, heating control, installation

8 A version:



12 A version:



16 A version:



Technical data of approved types on request

Contact data

Configuration	1 C/O contact or 1 N/O contact		
Type of contact	single contact		
Rated current	8 A	12 A	16 A
Rated voltage / max.breaking voltage AC	250 Vac / 440 Vac		
Maximum breaking capacity AC	2000 VA	3000 VA	4000 VA
Make current	16 A	20 A	25 A
Contact material	AgNi 0.15	AgCdO	AgCdO

Contact ratings

Type	Load	Operations	Standard
RP410	12 A, 250 Vac, $\cos\phi=1$, 1200/h, 40% duty cycle	1.1×10^5	AC 1
RP410	9.1 A, 220 Vac, $\cos\phi=1$, 360/h, 15% duty cycle	2×10^5	AC 1
RP418	3.4 A ON, 0.42 A OFF, 220 Vac, $\cos\phi=0.6$	$> 1.1 \times 10^6$	
RP411	8 A, 250 Vac, $\cos\phi=1$, 50% duty cycle	10^5	AC 1
RP412	8 A, 250 Vac, $\cos\phi=1$, 50% duty cycle	10^5	AC 1
RP330	18.2 A, 250 Vac, $\cos\phi=1$, 600/h, 15% duty cycle	1.1×10^5	AC 1
RP330	96 A ON, 16 A OFF, 250 Vac, $\cos\phi=0.6$, 450/h	$> 3 \times 10^4$	VDE 0630

Coil data

Nominal voltage	5...110 Vdc
Nominal coil power	500 mW
Operate category	2 / b

Coil versions, DC-coil

Coil code	Nominal voltage Vdc	Pull-in voltage Vdc	Release voltage Vdc	Maximum voltage Vdc	Coil resistance Ω	Coil current mA
005	5	3.5	0.5	9.0	$54 \pm 10\%$	92.6
006	6	4.2	0.6	10.8	$68 \pm 10\%$	88.2
012	12	8.4	1.2	21.6	$270 \pm 10\%$	44.4
024	24	16.8	2.4	43.2	$1100 \pm 15\%$	21.8
048	48	33.6	4.8	86.4	$4400 \pm 15\%$	10.9
060	60	42.0	6.0	108.0	$6540 \pm 15\%$	9.2
110	110	77.0	11.0	198.0	$23100 \pm 15\%$	4.8

All figures are given for coil without preenergization, at ambient temperature +20°C
Other coil voltages on request

Max. DC load breaking capacity

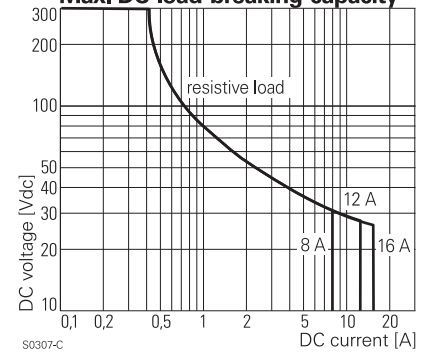

S0307-C

Electrical endurance

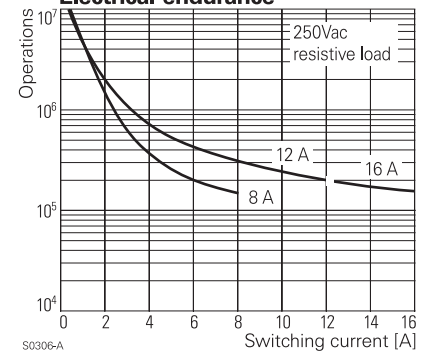

S0306-A

Coil operating range DC

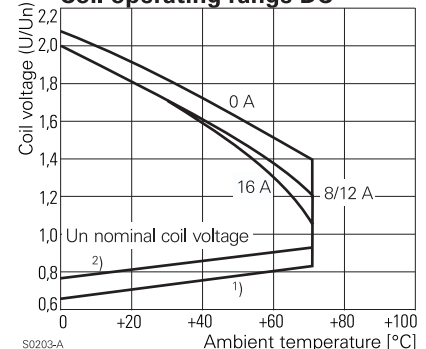

S0203-A

Power PCB Relay RP II/1

1 pole 8 / 12 / 16 A

Insulation		
Dielectric strength	coil-contacts	4000 V _{rms}
	open contact circuit	1000 V _{rms}
Clearance / creepage		8 / 8 mm
Insulation to IEC 60664		
Voltage rating		250 V
Pollution degree		3
Overvoltage category		III
Insulation to VDE 0110b (2/79)		
Insulation category / reference voltage		C / 250

Other data	
Ambient temperature	-40...+70 °C
Mechanical life	30x10 ⁶ operations
Max. switching rate at rated- / minimum load	10 min ⁻¹ / 1200 min ⁻¹
Operate- / release time	typ. 8 / 2 ms
Bounce time N/O contact/N/C contact	typ. 2 / 4 ms
Vibration resistance N/O contact/N/C contact	>10 / 2 g, 30...300 Hz
Shock resistance (destruction)	100 g
Category of protection (IEC 61810)	RT II - flux proof, RT III - wash tight
Relay weight	18 g
Packaging unit	20 / 500 pcs.
Accessories	see accessories RT and RT

Dimensions

Dimensions in mm

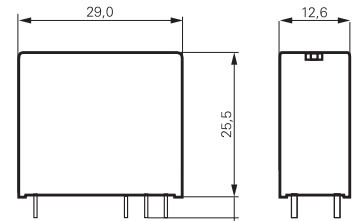

S0273-AA

View on solder pins

Dimensions in mm

PCB layout / terminal assignment

8 / 12 A, pinning 3.5 mm

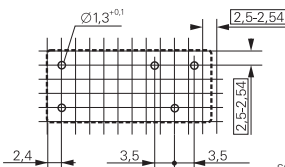

S0163-CQ

8 / 12 A, pinning 5 mm

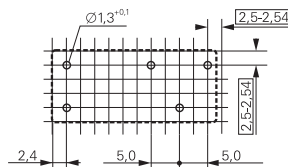

S0163-CP

16 A, pinning 5 mm

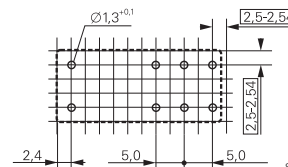

S0163-CO

1 C/O

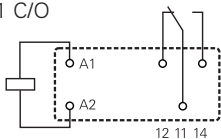

S0163-BG

1 C/O

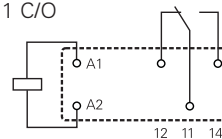

S0163-BC

1 C/O

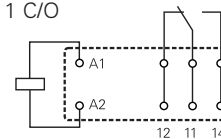

S0163-BE

1 N/O

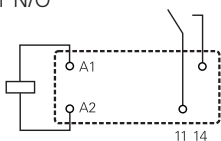

S0163-BH

1 N/O

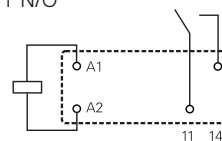

S0163-BD

1 N/O

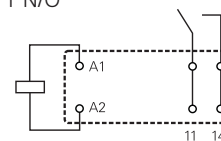

S0163-BF

Product key

Type

Version

3 16 A, flux proof **7 16 A, wash tight**
4 8/12 A, flux proof **8 8/12 A, wash tight**

Contacts

1 1 C/O contact **3 1 N/O contact**

Contact material

0 AgCdO, 16 A or 12 A, pinning 5 mm **2 AgNi 0.15, 8 A, pinning 3.5 mm**
1 AgNi 0.15, 8 A, pinning 5 mm **8 AgCdO, 12 A, pinning 3.5 mm**

Coil

Coil code: please refer to coil versions table

Preferred types in bold print

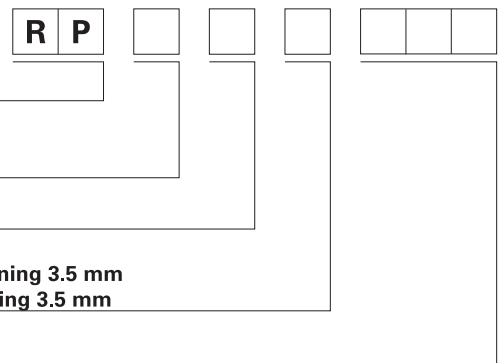

Power PCB Relay RP II/1

1 pole 8 / 12 / 16 A

Product key	Version	Contacts	Contact material	Coil	Part number
RP310005	16 A	1 C/O contact	AgCdO	5 Vdc	2-1393230-5
RP310012	flux proof		pinning 5mm	12 Vdc	2-1393230-9
RP310024				24 Vdc	3-1393230-2
RP310048				48 Vdc	3-1393230-3
RP330005		1 N/O contact		5 Vdc	4-1393230-5
RP330012				12 Vdc	4-1393230-7
RP330024				24 Vdc	4-1393230-9
RP330048				48 Vdc	5-1393230-1
RP410012	12 A	1 C/O contact	AgCdO	12 Vdc	8-1393230-1
RP410024	flux proof		pinning 5mm	24 Vdc	8-1393230-2
RP411012	8 A		AgNi 0.15	12 Vdc	9-1393230-4
RP411024	flux proof		pinning 5mm	24 Vdc	9-1393230-5
RP412012			AgNi 0.15	12 Vdc	1-1393231-1
RP412024			pinning 3.5mm	24 Vdc	1-1393231-2
RP418012	12 A		AgCdO	12 Vdc	2-1393231-5
RP418024	flux proof		pinning 3.5mm	24 Vdc	2-1393231-8
RP438012		1 N/O contact		12 Vdc	5-1393231-0
RP438024				24 Vdc	5-1393231-2
RP710005	16 A	1 C/O contact	AgCdO	5 Vdc	7-1393231-0
RP710012	wash tight		pinning 5mm	12 Vdc	7-1393231-2
RP710024				24 Vdc	7-1393231-5
RP710048				48 Vdc	7-1393231-6
RP730012		1 N/O contact		12 Vdc	8-1393231-2
RP730024				24 Vdc	8-1393231-4
RP812012	8 A	1 C/O contact	AgNi 0.15	12 Vdc	0-1393232-8
RP812024	wash tight		pinning 3.5mm	24 Vdc	0-1393232-9
RP818012	12 A		AgCdO	12 Vdc	1-1393232-7
RP818024	wash tight		pinning 3.5mm	24 Vdc	1-1393232-9
RP838012		1 N/O contact		12 Vdc	2-1393232-6
RP838024				24 Vdc	2-1393232-8

Special Load PCB Relay RP 3 SL

1 pole 16 A, for high inrush currents,
mono- or bistable



Features

- 1 N/O contact
- 120 A / 20 ms inrush peak current
- 4 kV / 8 mm coil-contact

Applications

Lighting control, timers, motor control, building automation



Technical data of approved types on request

F0147-A

Contact data

Configuration	1 N/O contact
Type of contact	single contact
Rated current	16 A
Rated voltage / max.breaking voltage AC	250 Vac / 440 Vac
Maximum breaking capacity AC	4000 VA
Make current (max. 4 s at duty cycle 10%)	25 A
Peak inrush current	120 A
Contact material	AgSnO ₂

Contact ratings

Type	Load	Operations	Standard
RP3SL	12 A, 250 Vac, cosφ=1	3x10 ⁵	
RP3SL	TV 8	25x10 ³	UL 508
RP3SL	2500 W, 230 Vac, halogen lamps	>10 ⁴	
RP3SL	1000 W, 250 Vac, incandescent lamps	2.3x10 ⁵	
RP3SL	3000 W, 250 Vac, incandescent lamps	3.6x10 ⁴	
RP3SL	1500 VA, fluorescent lamps 163 μF	10 ⁴	

Coil data monostable DC coil

Nominal voltage	5...110 Vdc
Nominal coil power	500 mW
Operate category	2 / b

Coil versions monostable DC coil

Coil code	Nominal voltage Vdc	Pull-in voltage Vdc	Release voltage Vdc	Maximum voltage Vdc	Coil resistance Ω	Coil current mA
012	12	9.0	1.2	21.6	270±10%	44.4
024	24	18.0	2.4	43.2	1100±15%	21.8
048	48	36.0	4.8	86.4	4400±15%	10.9
060	60	45.0	6.0	108.0	6540±15%	9.2

All figures are given for coil without preenergization, at ambient temperature +20°C
Other coil voltages on request

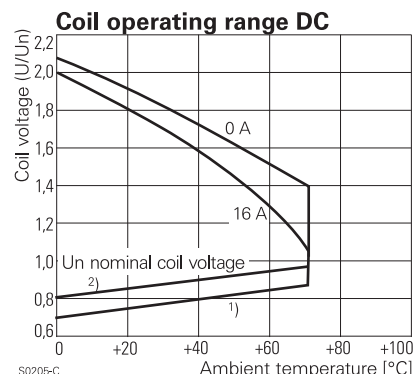
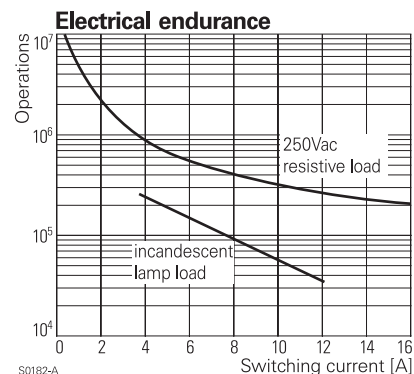
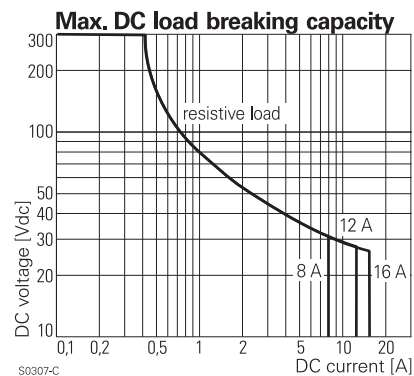

Special Load PCB Relay RP 3 SL

1 pole 16 A, for high inrush currents,
mono- or bistable

Coil data bistable	1 coil	2 coils
Nominal voltage	5...110 Vdc	5...60 Vdc
Nominal coil power	1.2...1.4 W	1.2...1.5 W
Minimum energization time	20 ms	
Reset voltage min.	70 % U_{nom}	75 % U_{nom}
Reset voltage max.	110 % U_{nom}	120 % U_{nom}

Coil versions bistable

Coil code	Nominal voltage Vdc	Pull-in voltage Vdc	Reset voltage Vdc	Reset R1 Ω / W	Coil resistance Ω	Coil current mA
bistable, 1 coil						
A05	5	3.7	3.6	39 / 0.5	21 ± 10%	238.1
A12	12	9.0	8.7	220 / 0.5	115 ± 10%	104.3
A24	24	18.0	16.7	820 / 0.5	460 ± 10%	52.2
bistable, 2 coils						
F12	12	9.0	9.0		105 ± 15%	114.3
F24	24	18.0	18.0		460 ± 15%	52.2

All figures are given for coil without preenergization, at ambient temperature +20°C, duty cycle 20%

Other coil voltages on request

Insulation

Dielectric strength	coil-contacts	4000 V_{rms}
	open contact circuit	2000 V_{rms}
Clearance / creepage		8 / 8 mm
Insulation to IEC 60664		
Voltage rating		250 V
Pollution degree		3
Overvoltage category		III
Insulation to VDE 0110b (2/79)		
Insulation category / reference voltage		C / 250

Other data

Ambient temperature	-40...+70 °C	
Mechanical life	30x10 ⁶ operations	
Max. switching rate at rated- / minimum load	10 min ⁻¹ / 1200 min ⁻¹	
Operate- / release time monostable	typ. 8 / 2 ms	
Operate- / reset time bistable	typ. 6 / 2 ms	
Bounce time	typ. 2 ms	
Vibration resistance	20 g, 30...300 Hz	
Shock resistance (destruction)	100 g	
Protection category	RT II - flux proof, RT III - wash tight	
Relay weight	18 g	
Packaging unit	1 coil	20 / 500 pcs.
	2 coils	25 / 100 pcs.
Accessories	see accessories RP	

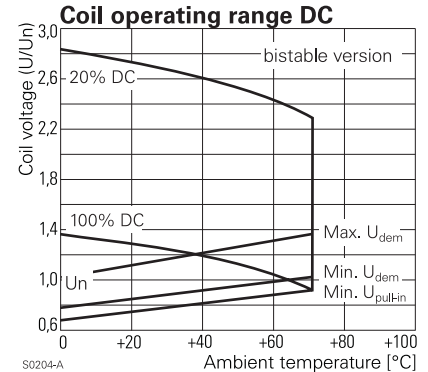

Circuit scheme for bistable 1 coil

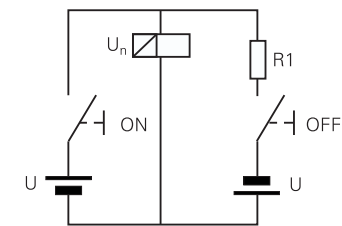

S0328-A

PCB layout / terminal assignment

View on solder pins
Dimensions in mm

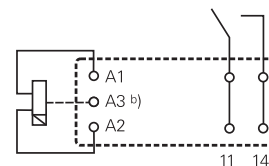
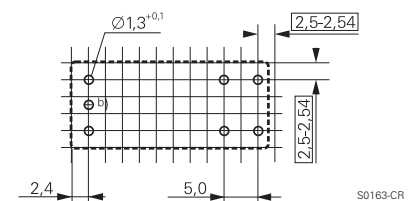

Bistable versions:
Indicated contact position during or after coil energization with reset voltage.

2-coil versions:
Operate A2, A3
Reset A1, A3

b) for 2 coil version only

Special Load PCB Relay RP 3 SL

1 pole 16 A, for high inrush currents,
mono- or bistable

Dimensions

Dimensions in mm

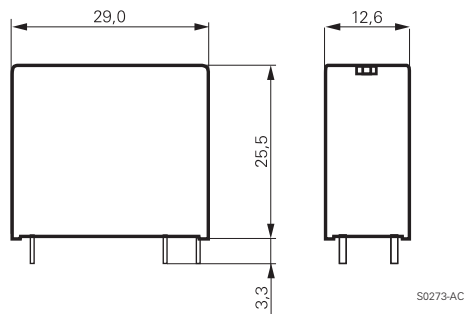

Product key

Type	R	P		S	L			
Version	3 flux proof							
Contacts / contact material	7 wash tight							
Coil	SL 1 N/O contact, AgSnO ₂							
Coil code: please refer to coil versions table								

Preferred types in bold print

Product key	Version	Contacts	Coil	Coil	Part number
RP3SL005	16 A	1 N/O contact	DC-coil	5 Vdc	0-1393230-7
RP3SL012	flux proof	AgSnO		12 Vdc	0-1393230-9
RP3SL024				24 Vdc	1-1393230-1
RP3SLA12			bistable	12 Vdc	0-1393230-3
RP3SLA24			1-coil	24 Vdc	0-1393230-4
RP3SLF12			bistable	12 Vdc	0-1393230-5
RP3SLF24			2-coils	24 Vdc	0-1393230-6
RP7SL012	16 A		DC-coil	12 Vdc	6-1393231-5
RP7SL024	wash tight			24 Vdc	6-1393231-6

Special Load PCB Relay 409 47, 409 67

1 pole 10 A, for high inrush currents,
mono- or bistable



F0249-A

Features

- Specifically designed to handle high inrush currents
- Tungsten prerun contact
- 500 A / 10 μ s inrush peak current
- 4 kV / 8 mm coil-contact
- meets protection class II requirements

Applications

Dimmer switches, movement sensors, filament loads, halogen bulbs, motors and electrovalves



Technical data of approved types on request

Contact data

Configuration	1 N/O contact
Type of contact	single contact
Rated current	10 A
Rated voltage / max.breaking voltage AC	250 Vac / 400 Vac
Maximum breaking capacity AC	2500 VA
Make current (max. 4 s at duty cycle 10%)	16 A
peak inrush current 10 μ s / 20 ms	500 / 120 A
Contact material	W (prerun contact) + AgCdO

Contact ratings

Type	Load	Operations	Standard
409	10 A, 250 Vac, resistive	2.5x10 ⁵	
409	1300 W, fluorescent lamps, 140 μ F	3x10 ⁴	
409	2500 W, incandescent lamps	3x10 ⁴	
409	1000 W, Dulux lamps, 140 μ F	3x10 ⁴	

Coil data

monostable DC coil

Nominal voltage	5...110 Vdc
Nominal coil power	820 mW
Operate category	2 / b

Coil versions monostable

Coil code	Nominal voltage Vdc	Pull-in voltage Vdc	Release voltage Vdc	Maximum voltage Vdc	Coil resistance Ω	Coil current mA
031	12	7.5	0.9	14.2	170\pm10%	71.0
027	24	18.0	1.8	34.6	880\pm15%	27.0
024	48	34.5	3.6	60.6	2700 \pm 15%	18.0
023	60	41.0	4.5	77.8	4400 \pm 15%	14.0

All figures are given for coil without preenergization, at ambient temperature +20°C

Other coil voltages on request

Coil operating range DC

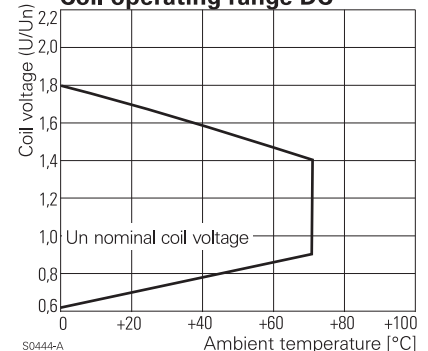

S0444-A

Special Load PCB Relay 409 47, 409 67

1 pole 10 A, for high inrush currents,
mono- or bistable

Coil data bistable	1 coil
Nominal voltage	6...100 Vdc
Nominal coil power	0.8...1 W
Minimum energization time	20 ms

Coil versions bistable, 1 coil

Coil code	Nominal voltage Vdc	Pull-in voltage Vdc	Reset voltage min Vdc	Reset voltage max Vdc	Coil resistance Ω	Coil current mA
032	12	8.9	0.7	2.5	118 \pm 10%	102.0
029	24	18.0	1.3	5.0	457 \pm 10%	53.0

All figures are given for coil without preenergization, at ambient temperature +20°C, duty cycle 20%

Other coil voltages on request

Insulation

Dielectric strength	coil-contacts	4000 V _{rms}
	open contact circuit	1000 V _{rms}
Clearance / creepage		8 / 8 mm
Insulation to VDE 0110b (2/79)		
	Insulation category / reference voltage	C / 250
Tracking resistance of relay base		PTI 250

Other data

Flammability class according to UL 94	V-0
Ambient temperature	-20...+70 °C
Mechanical life	30x10 ⁶ operations
Max. switching rate at rated- / minimum load	15 min ⁻¹ / 1200 min ⁻¹
Operate- / release time	typ. 10 / 3 ms
Bounce time	typ. 3 ms
Vibration resistance	20 g (30...300 Hz)
Shock resistance (destruction)	100 g
Category of protection (IEC 61810)	RT II - flux proof
Relay weight	16 g
Packaging unit	25 / 250 pcs.

PCB layout / terminal assignment

View on solder pins
Dimensions in mm

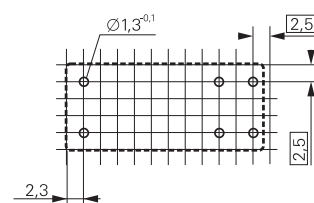

S0163-CX

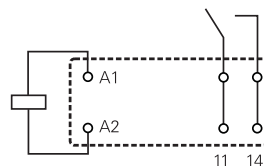

S0163-BF

Bistable versions:
Indicated contact position during or after coil energization with reset voltage.

Special Load PCB Relay 409 47, 409 67

1 pole 10 A, for high inrush currents,
mono- or bistable

Dimensions

Dimensions in mm

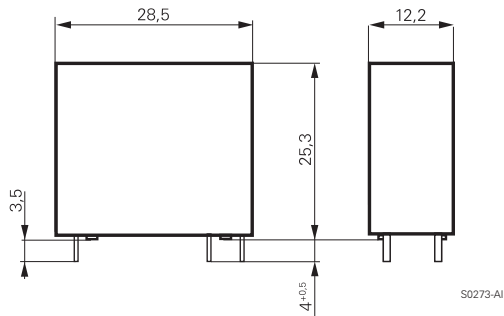

Product key

0 4 0 9 **7** **0 0 1**

Type

Coil version

- 47** Monostable version
- 67** Bistable version

Coil

Coil code: Please refer to coil versions table, preferred types in bold print

Contact configuration

- 001** 1 N/O contact

Other types on request

Product key	Version	Contacts	Coil	Coil	Part number
0409 47 031 001	10A	1 N/O	DC-coil	12Vdc	1-1415403-6
0409 47 028 001	flux proof	W prerun		24Vdc	1-1415403-4
0409 67 032 001		AgCdO	bistable	12Vdc	0-1415405-0
0409 67 029 001			1 coil	24Vdc	0-1415405-1

Faston Power Relay IF 125°C

1 pole 16 A



F0148-B

Features

- 1 N/O or 1 N/C contact
- 16 A rated current
- Switching capacity 4000 VA
- Coil power 360 mW
- 4 kV / 8 mm coil-contact, insulation to VDE 0631 and 0700
- Ambient temperature up to 125°C
- Faston-terminals for load side

Applications

Oven control, electric heating, power supplies, air conditioning



Technical data of approved types on request

Contact data

Configuration	1 N/O contact or 1 N/C contact
Type of contact	single contact
Rated current	16 A
Rated voltage / max.breaking voltage AC	250 Vac / 440 Vac
Maximum breaking capacity AC	4000 VA
Make current (max. 4 s at duty cycle 10%)	25 A
Contact material	AgCdO
Minimum contact load	500 mA, 12 Vac

Contact ratings

Type	Load	Operations
-A402	10 A, 400 Vac, resistive, 125 °C	2x10 ⁵
-A402	16 A, 250 Vac, resistive, 125 °C	1x10 ⁵
-A403	10 A, 400 Vac, resistive, 125 °C	5x10 ⁴
-A403	16 A, 250 Vac, resistive, 125 °C	5x10 ⁴

Coil data

Nominal voltage	6...48 Vdc
Nominal coil power	360 mW
Operate category	1 / c

Coil versions

Coil code	Nominal voltage Vdc	Pull-in voltage Vdc	Release voltage Vdc	Maximum voltage Vdc	Coil resistance Ω	Coil current mA
003	6	3.8	0.6	16.9	100±10%	60.0
005	12	7.5	1.2	33.8	400±10%	30.0
007	24	14.9	2.4	67.7	1600±10%	15.0
009	48	30.0	4.8	135.3	6400±10%	7.5

All figures are given for coil without preenergization, at ambient temperature +20°C

Other coil voltages on request

Insulation

Dielectric strength	coil-contacts	4000 V _{rms}
	open contact circuit	1000 V _{rms}
Clearance / creepage		8 / 8 mm
Insulation to IEC 60664		
	Voltage rating	250 V
	Pollution degree	3
	Overtoltage category	III
Insulation to VDE 0110b (2/79)		
	Insulation category / reference voltage	C / 250, B / 380
Tracking resistance of relay base		PTI 250

Max. DC load breaking capacity

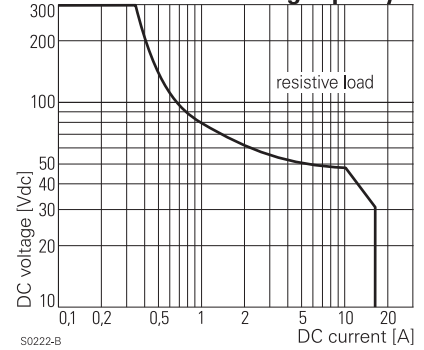

Electrical endurance

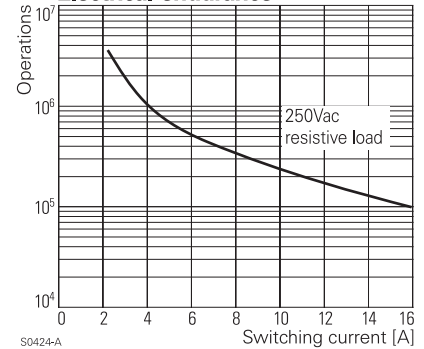

Coil operating range DC

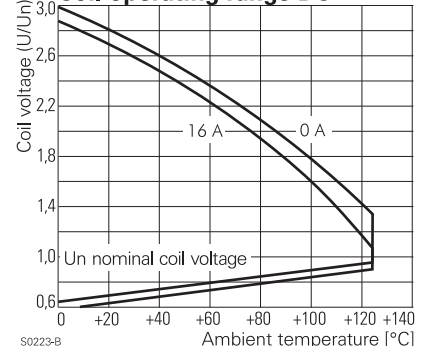

Faston Power Relay IF 125°C

1 pole 16 A

Other data

Flammability class according to UL 94	V-0
Ambient temperature	-40...+125 °C
Mechanical life	30x10 ⁶ operations
Max. switching rate at rated- / minimum load	10 min ⁻¹ / 1200 min ⁻¹
Operate- / release time	10 / 2 ms
Bounce time N/O contact/N/C contact	1 / 2 ms
Category of protection (IEC 61810)	RT II - flux proof
Relay weight	26 g
Packaging unit	15 / 300 pcs.

PCB layout / terminal assignment

View on solder pins
Dimensions in mm

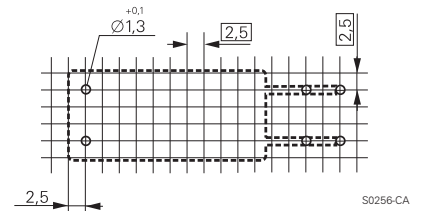

Dimensions

Dimensions in mm

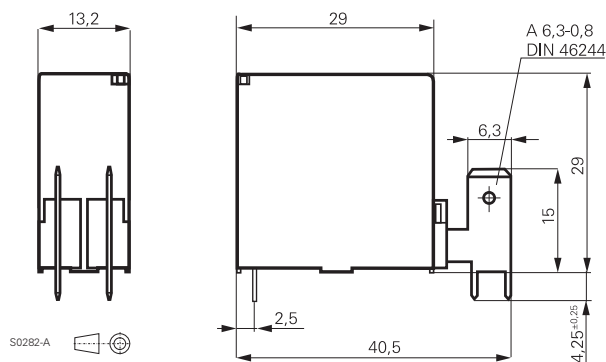

1 N/O contact

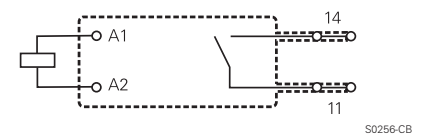

1 N/C contact

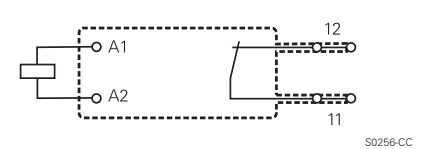

Product key

V 2 3 0 7 7 - A 1 - A 4

Type

Version

A PCB terminals (coil) and
Faston terminals (contacts); flux proof

Version

1 standard

Coil

003 6 V **007** 24 V
005 12 V **009** 48 V

Contact type

A single contact

Contact material

4 AgCdO

Contact configuration

02 1 N/O contact **03** 1 N/C contact

Other types on request

Product key	Version	Cont-material	Cont.configuration	Coil	Part number
V23077-A1003-A402	standard	AgCdO	1 N/O contact	6 Vdc	0-1393199-4
V23077-A1005-A402	PCB terminals			12 Vdc	0-1393199-7
V23077-A1005-A403	Faston terminals		1 N/C contact		0-1393199-9
V23077-A1007-A402	flux proof		1 N/O contact	24 Vdc	1-1393199-2
V23077-A1007-A403			1 N/C contact		1-1393199-3
V23077-A1009-A402			1 N/O contact	48 Vdc	1-1393199-5
V23077-A1009-A403			1 N/C contact		1-1393199-6

Faston Power Relay 410 63 125°C

1 pole 16 A



F0248-AA

Features

- 1 N/O or 1 N/C contact
- 16 A rated current
- Switching capacity 4000 VA
- Coil power 360 mW
- 4 kV / 8 mm coil-contact, insulation to VDE 0631 and 0700
- Ambient temperature up to 125°C
- Faston-terminals for load side

Applications

White goods appliances, oven control, electric heating, power supplies, air conditioning, motors, magnetic valves



Technical data of approved types on request

Contact data

Configuration	1 N/O contact or 1 N/C contact
Type of contact	single contact
Rated current	16 A
Rated voltage / max.breaking voltage AC	250 Vac / 400 Vac
Maximum breaking capacity AC	4000 VA
Make current (max. 4 s at duty cycle 10%)	25 A
Contact material	AgCdO

Contact ratings

Type	Load	Operations
N/O cont.	16 A, 250 Vac, resistive, 125 °C	1x10 ⁵
N/O cont.	12 A, 250 Vac, resistive, 70 °C	4.5x10 ⁵
N/C cont.	16 A, 250 Vac, resistive, 125 °C	1.5x10 ⁵
N/O cont.	10 A, 400 Vac, resistive, 125 °C	5x10 ⁴
N/O cont.	12 A, 250 Vac, cosφ=0.6, 125 °C	5x10 ⁴

Coil data

Nominal voltage	6...60 Vdc
Nominal coil power	360 mW
Operate category	1 / b

Coil versions

Coil code	Nominal voltage Vdc	Pull-in voltage Vdc	Release voltage Vdc	Maximum voltage Vdc	Coil resistance Ω	Coil current mA
054	6	3.6	0.45	17.0	100±10%	60.0
050	12	7.3	0.9	35.0	400±10%	30.0
046	24	14.6	1.8	67.0	1600±10%	15.0
043	48	29.2	3.6	135.0	6400±10%	7.5
042	60	36.5	4.5	168.0	10000±10%	6.0

All figures are given for coil without preenergization, at ambient temperature +20°C
Other coil voltages on request

Insulation

Dielectric strength	coil-contacts	4000 V _{rms}
	open contact circuit	1000 V _{rms}
Clearance / creepage		8 mm
Insulation to IEC 60664		
	Voltage rating	250 V
	Pollution degree	3
	Overvoltage category	III
Insulation to VDE 0110b (2/79)		
	Insulation category / reference voltage	C / 250
Tracking resistance of relay base		PTI 250

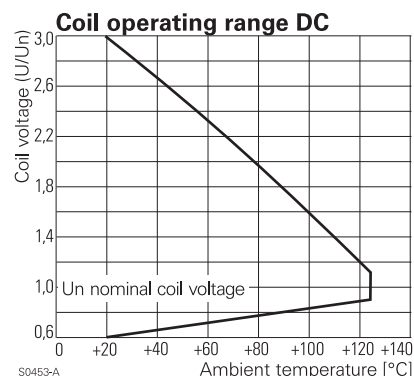
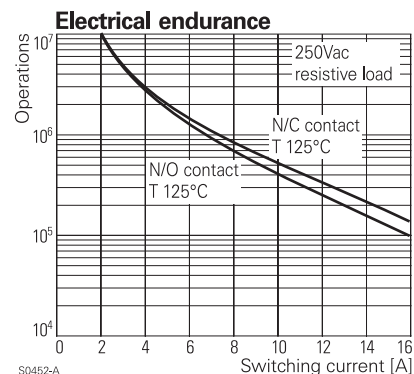

Faston Power Relay 410 83 3 mm

1 pole 16 A, 3 mm contact gap



F0248-AB

Features

- 1 N/O bridging contact
- Contact gap > 3 mm
- 16 A rated current
- Switching capacity 4000 VA
- Coil power 360 mW
- 4 kV / 8 mm coil-contact, insulation to VDE 0631 and 0700
- Ambient temperature up to 85°C
- Faston-terminals for load side

Applications

Washing machines, tumble dryers, absolute safe power supply disconnection in other domestic applications



Technical data of approved types on request

Contact data

Configuration	1 N/O contact
Type of contact	single contact, bridging contact
Rated current	16 A
Rated voltage / max.breaking voltage AC	250 Vac / 400 Vac
Maximum breaking capacity AC	4000 VA
Make current (max. 4 s at duty cycle 10%)	20 A
Contact material	AgNi
Contact gap	>3 mm

Contact ratings

Type	Load	Operations
410 83	16 A, 250 Vac, resistive, 85 °C	3x10 ⁴
410 83	10 A, 250 Vac, resistive, 85 °C	1x10 ⁵
410 83	10 A, 400 Vac, resistive, 85 °C	1x10 ⁵

Coil data

Nominal voltage	6...60 Vdc
Nominal coil power	360 mW
Operate category	1 / c

Coil versions

Coil code	Nominal voltage Vdc	Pull-in voltage Vdc	Release voltage Vdc	Maximum voltage Vdc	Coil resistance Ω	Coil current mA
054	6	3.9	0.45	13.2	100±10%	60.0
050	12	7.9	0.9	26.4	400±10%	30.0
046	24	15.8	1.8	53.0	1600±10%	15.0
043	48	31.6	3.6	106.0	6400±10%	7.5
042	60	39.5	4.5	132.0	10000±10%	3.7

All figures are given for coil without preenergization, at ambient temperature +20°C

Other coil voltages on request

Insulation

Dielectric strength	coil-contacts	4000 V _{rms}
	open contact circuit	2000 V _{rms}
Clearance / creepage		8 / 8 mm
Insulation to IEC 60664		
Voltage rating		250 V
Pollution degree		3
Overvoltage category		III
Insulation to VDE 0110b (2/79)		
Insulation category / reference voltage		C / 250
Tracking resistance of relay base		PTI 250

Max. DC load breaking capacity

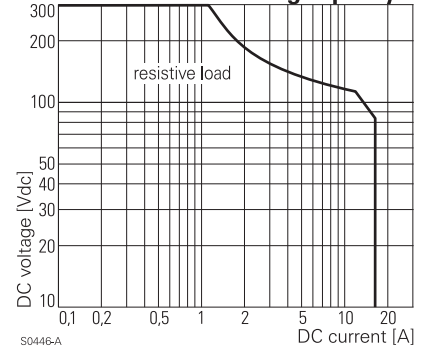

Electrical endurance

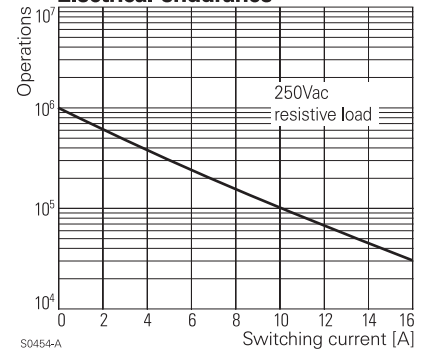

Coil operating range DC

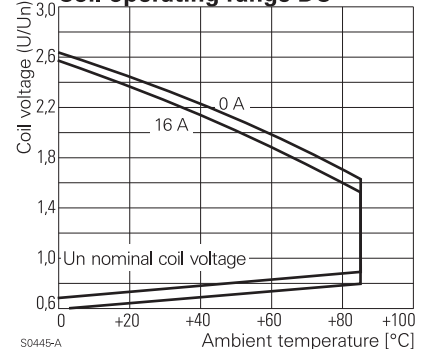

Faston Power Relay 410 83 3 mm

1 pole 16 A, 3 mm contact gap

Other data

Flammability class according to UL 94	V-0
Ambient temperature	-20...+85 °C
Mechanical life	1x10 ⁷ operations
Max. switching rate at rated- / minimum load	10 min ⁻¹ / 600 min ⁻¹
Operate- / release time	typ. 14 / 5 ms
Bounce time	typ. 3 ms
Vibration resistance	10 g, 10...500 Hz
Shock resistance (destruction)	100 g
Category of protection (IEC 61810)	RT II - flux proof
Relay weight	24 g
Packaging unit	20 / 75 / 1050 pcs.

PCB layout / terminal assignment

View on solder pins
Dimensions in mm

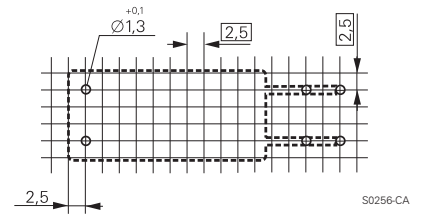

Dimensions

Dimensions in mm

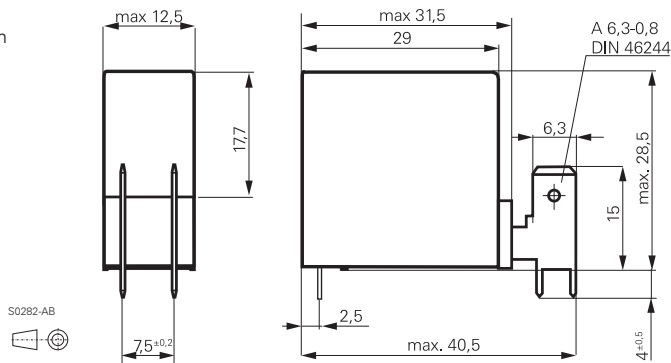

1 N/O bridging contact

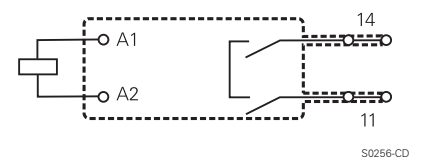

Product key

0 4 1 0 **8 3** **0 0 1**

Type

Coil

Coil code: Please refer to coil versions table, preferred types in bold print

Version

001 1 N/O contact

Other types on request

Product key	Version	Cont-material	Cont.configuration	Coil	Part number
0410 83 050 001	standard	AgCdO	1 N/O contact	12Vdc	4-1415410-9
0410 83 046 001	PCB/Faston			24Vdc	4-1415410-8

Power PCB Relay RT2

2 pole 8 A, DC and AC-coil



Features

- 2 C/O or 2 N/O contacts
- Sensitive coil 400 mW
- DC- or AC-coil
- 5 kV / 10 mm coil-contact
- Protection class II (VDE 0700)
- Height 15.7 mm
- Sockets with PCB-type or screw-type terminals

Applications

Domestic appliances, heating control, emergency lighting, modems

F0149-B



Technical data of approved types on request

Contact data

Configuration	2 C/O contact or 2 N/O contact
Type of contact	single contact
Rated current	8 A
Rated voltage / max.breaking voltage AC	250 Vac / 440 Vac
Maximum breaking capacity AC	2000 VA
Make current (max. 4 s at duty cycle 10%)	15 A
Contact material	AgNi 90/10, AgNi 90/10 gold plated

Contact ratings

Type	Load	Operations	Standard
RT 424	4 A, 230 Vac, $\cos\phi=0.6$	1.5×10^5	Standard
RT 424	6 (2) A, 250 Vac, on the N/O- N/C contact		VDE 0631
RT 424	1/2 hp / 240 Vac, 1/4 hp / 120 Vac	6×10^3	UL 508

Coil data

	DC coil		5...110 Vdc
	Nominal voltage	AC coil	
Nominal coil power	DC coil	400 mW	24...230 Vac
	AC coil	0.75 VA	
Operate category			2 / b

Coil versions, DC-coil

Coil code	Nominal voltage Vdc	Pull-in voltage Vdc	Release voltage Vdc	Maximum voltage Vdc	Coil resistance Ω	Coil current mA
005	5	3.5	0.5	12.7	$62 \pm 10\%$	80.0
006	6	4.2	0.6	15.3	$90 \pm 10\%$	66.7
012	12	8.4	1.2	30.6	$360 \pm 10\%$	33.3
024	24	16.8	2.4	61.2	$1440 \pm 10\%$	16.7
048	48	33.6	4.8	122.4	$5520 \pm 10\%$	8.7
060	60	42.0	6.0	153.0	$7340 \pm 12\%$	8.1
110	110	77.0	11.0	280.5	$26600 \pm 12\%$	4.1

All figures are given for coil without preenergization, at ambient temperature +20°C Other coil voltages on request

Max. DC load breaking capacity

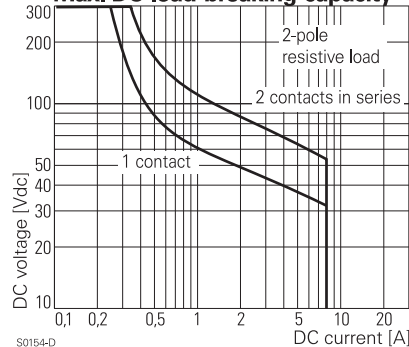

S0154-D

Electrical endurance

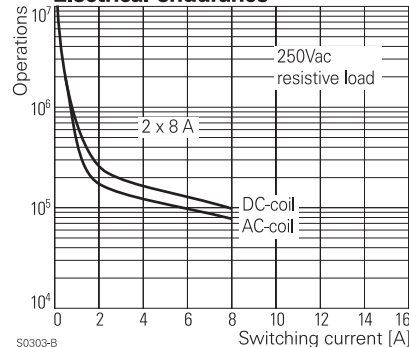

S0303-B

Coil operating range DC

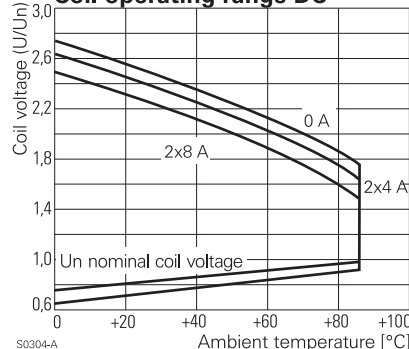

S0304-A

Power PCB Relay RT2

2 pole 8 A, DC and AC-coil

Coil versions, AC-coil

Coil code	Nominal voltage Vac	Pull-in voltage Vac	Release voltage Vac	Maximum voltage Vac	Coil resistance Ω	Coil current mA
524	24	18.0	3.6	36.0	350 ± 10%	31.6
615	115	86.3	17.3	172.5	8100 ± 15%	6.6
730	230	172.5	34.5	345.0	32500 ± 15%	3.2

All figures are given for coil without preenergization, at ambient temperature +20°C

Insulation

Dielectric strength	coil-contacts	5000 V_{rms}
	open contact circuit	1000 V_{rms}
	adjacent contacts	2500 V_{rms}
Clearance / creepage		10 / 10 mm
Insulation to IEC 60664		
Voltage rating		250 V
Pollution degree		3
Overvoltage category		III
Insulation to VDE 0110b (2/79)		
Insulation category / reference voltage		C / 250

Other data

Flammability class according to UL 94	V-0
Coil insulation system according to UL 1446	Class F
Ambient temperature	-40...+70 °C
Mechanical life	DC-coil >30x10 ⁶ operations AC-coil >5x10 ⁶ operations
Max. switching rate at rated- / minimum load	6 min ⁻¹ / 1200 min ⁻¹
Operate- / release time DC-coil	typ. 7 / 2 ms
Bounce time N/O contact/N/C contact	typ. 1 / 3 ms
Vibration resistance N/O / N/C contact	20 / 5 g, 30...300 Hz
Shock resistance (destruction)	100 g
Category of protection (IEC 61810)	RT II - flux proof, RT III - wash tight
Relay weight	13 g
Packaging unit	20 / 500 pcs.
Accessories	see accessories RT

Coil operating range AC

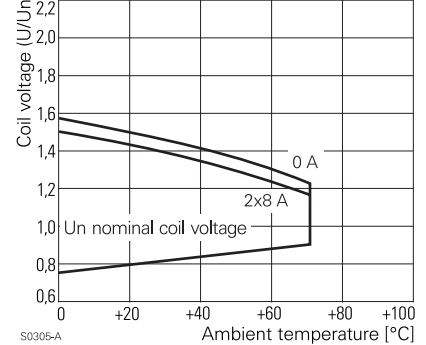

PCB layout / terminal assignment

View on solder pins
Dimensions in mm

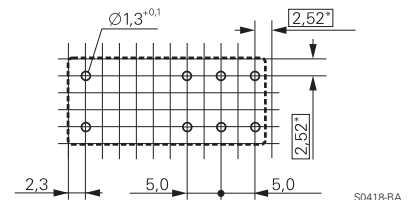

*) With the recommended PCB hole sizes a grid pattern from 2.5 mm to 2.54 mm can be used.

Dimensions

Dimensions in mm

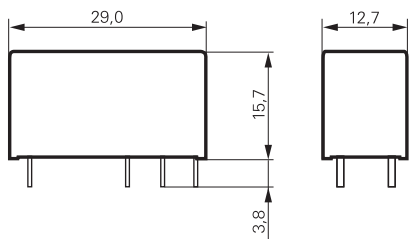

2 C/O contacts

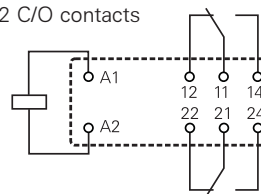

2 N/O contacts

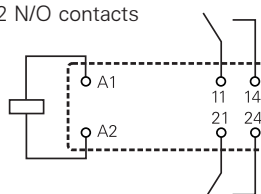

Power PCB Relay RT2

2 pole 8 A, DC and AC-coil

Product key

R	T	4				
----------	----------	----------	--	--	--	--

Type

Version

4 8 A, pinning 5 mm, flux proof

E 8 A, pinning 5 mm, wash tight

Contacts

2 2 C/O contacts **4 2 N/O contacts**

Contact material

4 AgNi 90/10 **5 AgNi 90/10 gold plated**

Coil

Coil code: please refer to coil versions table

Preferred types in bold print

Product key	Version	Contacts	Cont. material	Coil	Coil	Part number
RT424005	8 A	2 C/O contacts	AgNi 90/10	DC-coil	5 Vdc	5-1393243-9
RT424006	pinning 5 mm				6 Vdc	6-1393243-1
RT424012	flux proof				12 Vdc	6-1393243-3
RT424024					24 Vdc	6-1393243-8
RT424048					48 Vdc	7-1393243-0
RT424060					60 Vdc	7-1393243-3
RT424110					110 Vdc	7-1393243-5
RT424524				AC-coil	24 Vac	7-1393243-6
RT424615					115 Vac	7-1393243-8
RT424730					230 Vac	7-1393243-9
RT425005			AgNi 90/10	DC-coil	5 Vdc	8-1393243-0
RT425012			gold plated		12 Vdc	8-1393243-2
RT425024					24 Vdc	8-1393243-5
RT425524				AC-coil	24 Vac	9-1393243-1
RT425615					115 Vac	9-1393243-2
RT425730					230 Vac	9-1393243-3
RT444012		2 N/O contacts	AgNi 90/10	DC-coil	12 Vdc	9-1393243-7
RT444024					24 Vdc	9-1393243-9
RTE24005	8 A	2 C/O contacts			5 Vdc	0-1393243-1
RTE24006	pinning 5 mm				6 Vdc	0-1393243-2
RTE24012	wash tight				12 Vdc	0-1393243-4
RTE24024					24 Vdc	1-1393243-0
RTE24048					48 Vdc	1-1393243-1
RTE24060					60 Vdc	1-1393243-3
RTE24110					110 Vdc	1-1393243-4
RTE24524				AC-coil	24 Vac	1-1393243-5
RTE24615					115 Vac	1-1393243-7
RTE24730					230 Vac	1-1393243-8
RTE25005			AgNi 90/10	DC-coil	5 Vdc	1-1393243-9
RTE25012			gold plated		12 Vdc	2-1393243-0
RTE25024					24 Vdc	2-1393243-1

Power PCB Relay RT2 bistable

2 pole 8 A, polarized bistable version



Features

- 2 C/O contacts
- Bistable with 1 or 2 coils
- 5 kV / 10 mm coil-contact
- Height 15.7 mm
- Cadmium-free contacts
- Protection class II (VDE 0700)

Applications

Battery powered equipment or applications with "memory function" (e.g. mains failure)

F0219-B



Technical data of approved types on request

Contact data

Configuration	2 C/O contact
Type of contact	single contact
Rated current	8 A
Rated voltage / max. breaking voltage AC	250 Vac / 440 Vac
Maximum breaking capacity AC	2000 VA
Make current (max. 4 s at duty cycle 10%)	15 A
Contact material	AgNi 90/10

Coil data

	1 coil	2 coils
Nominal voltage	5...24 Vdc	
Nominal coil power	typ. 400 mW	typ. 600 mW
Minimum energization time	30 ms	
Information on reduced pulse duration with higher energization voltages on demand		
Max. energization time for version with 2 coils	1 min at <10% duty cycle	
Reset voltage min.	70 % U_{nom}	70 % U_{nom}
Reset voltage max.	120 % U_{nom}	150 % U_{nom}

Coil versions, bistable

Coil code	Nominal voltage Vdc	Pull-in voltage Vdc	Reset voltage Vdc	Coil resistance Ω	Coil current mA
bistable, 1 coil					
A05	5	3.5	3.5	62 ± 10%	80.0
A06	6	4.2	4.2	90 ± 10%	66.7
A12	12	8.4	8.4	360 ± 10%	33.3
A24	24	16.8	16.8	1440 ± 10%	16.7
bistable, 2 coils					
F05	5	3.5	3.5	42 ± 10%	120.0
F06	6	4.2	4.2	55 ± 10%	110.0
F12	12	8.4	8.4	240 ± 10%	50.0
F24	24	16.8	16.8	886 ± 10%	27.0

All figures are given for coil without preenergization, at ambient temperature +20°C
Other coil voltages on request

Coils - operation

Version	1 coil		2 coils		
Coil terminals	A1	A2	A1	A3	A2
Pull-in	+	-		+	-
Reset	-	+	-	+	

Contact position not defined at delivery

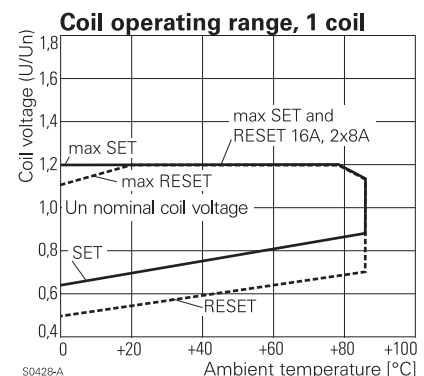
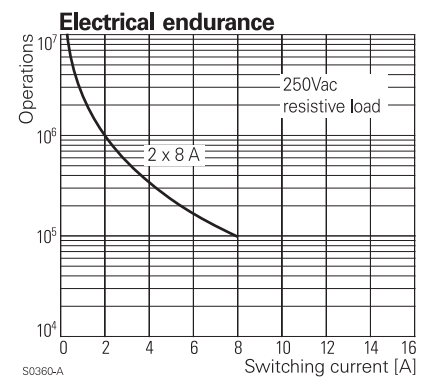
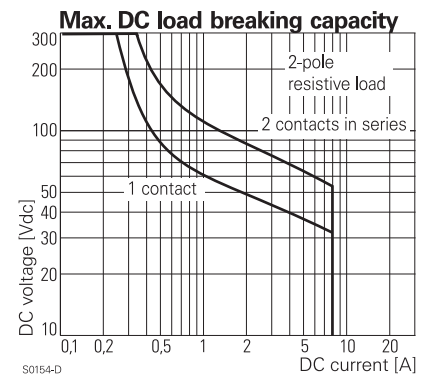

Power PCB Relay RT2 bistable

2 pole 8 A, polarized bistable version

Insulation

Dielectric strength	coil-contacts	5000 V _{rms}
	open contact circuit	1000 V _{rms}
	adjacent contacts	2500 V _{rms}
Clearance / creepage		10 / 10 mm
Insulation to IEC 60664		
Voltage rating		250 V
Pollution degree		3
Overvoltage category		III
Insulation to VDE 0110b (2/79)		
Insulation category / reference voltage		C / 250

Other data

Flammability class according to UL 94	V-0
Coil insulation system according to UL 1446	Class F
Ambient temperature	-40...+85 °C (UL: +70 °C)
Mechanical life	2x10 ⁶ operations
Max. switching rate at rated- / minimum load	6 min ⁻¹ / 600 min ⁻¹
Operate- / release time	typ. 5 / 3 ms
Bounce time N/O contact/N/C contact	typ. 1 / 4 ms
Vibration resistance / shock resistance	
opening N/C contact	3 / 5 g
opening closed N/O contact	6 / 15 g
Shock resistance (destruction)	100 g
Category of protection (IEC 61810)	RT II - flux proof
Relay weight	13 g
Packaging unit	1 coil 20 / 500 pcs. 2 coils 25 / 100 pcs.
Accessories	see accessories RT

Dimensions

Dimensions in mm

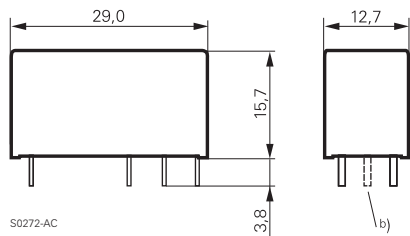

a) Indicated contact position while or after coil energization with reset voltage.

b) for 2 coil version only

Coil operating range, 2 coils

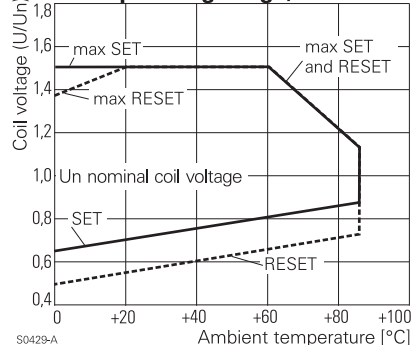

PCB layout / terminal assignment

View on solder pins
Dimensions in mm

8 A, Pinning 5 mm

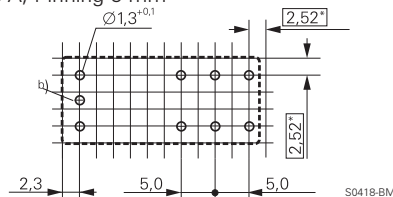

*) With the recommended PCB hole sizes a grid pattern from 2.5 mm to 2.54 mm can be used.

2 C/O contacts

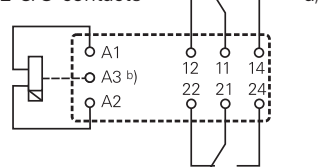

Product key

Type

Version

4 8 A, pinning 5 mm, flux proof

Contacts

2 2 C/O contacts

Contact material

4 AgNi 90/10

Coil

Coil code: please refer to coil versions table, preferred types in bold print

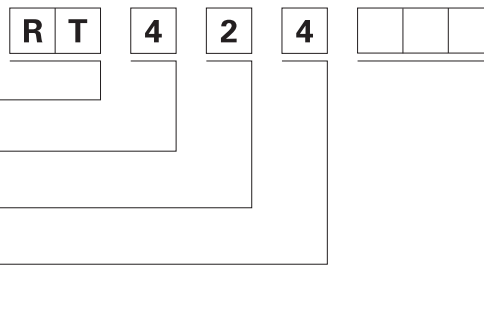

Product key	Version	Contacts	Cont. material	Coil	Coil	Part number
RT424A12	8 A	2 C/O contacts	AgNi 90/10	bistable	12 Vdc	4-1393243-6
RT424A24	pinning 5 mm			1 coil	24 Vdc	4-1393243-7
RT424F12	flux proof			bistable	12 Vdc	5-1393243-4
RT424F24				2 coils	24 Vdc	5-1393243-6

Power PCB Relay RP II/2

2 pole 8 A



Features

- 2 C/O or 2 N/O contacts
- 4 kV / 8 mm coil-contact
- Twin contacts available
- PCB-sockets

Applications

Domestic appliances, UPS's



Technical data of approved types on request

F0150-B

Contact data

Configuration	2 C/O contact or 2 N/O contact
Type of contact	single contact
Rated current	8 A (UL: 10 A)
Rated voltage / max.breaking voltage AC	250 Vac / 440 Vac
Maximum breaking capacity AC	2000 VA
Make current (max. 4 s at duty cycle 10%)	14 A
Contact material	AgNi 0.15, AgCdO

Contact ratings

Type	Load	Operations	Standard
RP440	64 A ON, 2 A OFF, 250 Vac	1x10 ⁴	VDE 0860
RP421	2 A, 50 Vdc, resistive	approx. 2x10 ⁶	
RP421	1/10hp, 240 Vac, per contact		UL 508
RP421	3 A, 380 Vac, AC11	approx. 3x10 ⁴	VDE 0660
RP421	0.18 A, 110 Vdc, DC11	approx. 1x10 ⁵	VDE 0660
RP420	0.6 A, 220 Vac, cosφ=0.8, single phase motor	approx. 1.3x10 ⁶	

Coil data

Nominal voltage	5...110 Vdc
Nominal coil power	500 mW
Operate category	2 / b

Coil versions, DC-coil

Coil code	Nominal voltage Vdc	Pull-in voltage Vdc	Release voltage Vdc	Maximum voltage Vdc	Coil resistance Ω	Coil current mA
005	5	3.5	0.5	9.0	54±10%	92.6
006	6	4.2	0.6	10.8	68±10%	88.2
012	12	8.4	1.2	21.6	270±10%	44.4
024	24	16.8	2.4	43.2	1100±15%	21.8
048	48	33.6	4.8	86.4	4400±15%	10.9
060	60	42.0	6.0	108.0	6540±15%	9.2
110	110	77.0	11.0	198.0	23100±15%	4.8

All figures are given for coil without preenergization, at ambient temperature +20°C
Other coil voltages on request

Insulation

Dielectric strength	coil-contacts	4000 V _{rms}
	open contact circuit	1000 V _{rms}
	adjacent contacts	2500 V _{rms}
Clearance / creepage		8 / 8 mm

Max. DC load breaking capacity

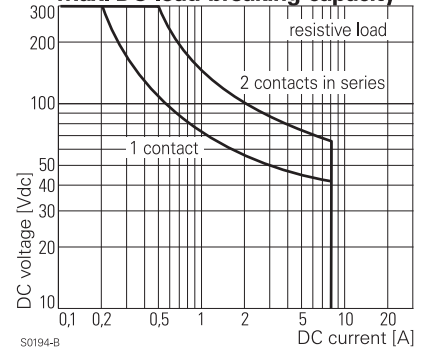

S0194-B

Electrical endurance

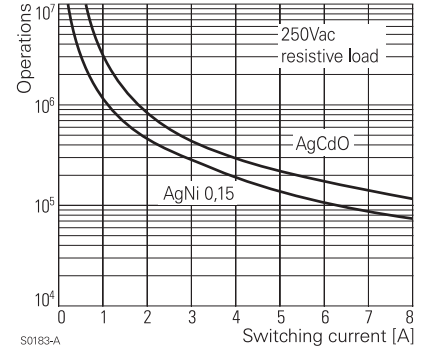

S0183-A

Coil operating range DC

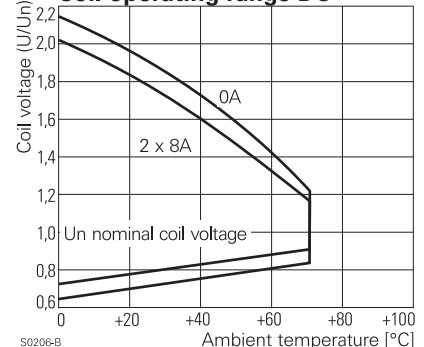

S0206-B

Power PCB Relay RP II/2

2 pole 8 A

Insulation

Insulation to IEC 60664	
Voltage rating	250 V
Pollution degree	3
Overvoltage category	III
Insulation to VDE 0110b (2/79)	
Insulation category / reference voltage	C / 250

Other data

Ambient temperature	-40...+70 °C
Mechanical life	20x10 ⁶ operations
Max. switching rate at rated- / minimum load	10 min ⁻¹ / 1200 min ⁻¹
Operate- / release time	typ. 9 / 3 ms
Bounce time N/O contact/N/C contact	typ. 2 / 3 ms
Vibration resistance N/O / N/C contact	11 / 1.5 g, 30...150 Hz
Shock resistance (destruction)	100 g
Category of protection (IEC 61810)	RT II - flux proof, RT III - wash tight
Relay weight	18 g
Packaging unit	20 / 500 pcs.
Accessories	see accessories RT and RP

PCB layout / terminal assignment

View on solder pins
Dimensions in mm

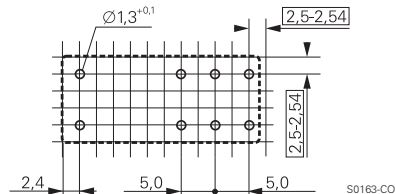

2 C/O contacts

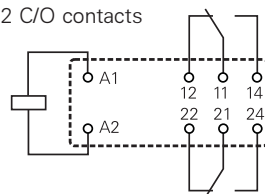

2 N/O contacts

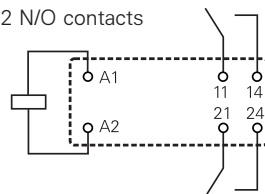

Dimensions

Dimensions in mm

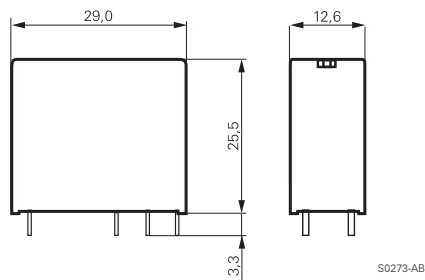

Product key

Type

Version

4 8 A, flux proof **8** 8 A, wash tight

Contacts

2 2 C/O contacts **4** 2 N/O contacts

Contact material

0 AgCdO **1** AgNi 0.15

Coil

Coil code: please refer to coil versions table

Preferred types in bold print

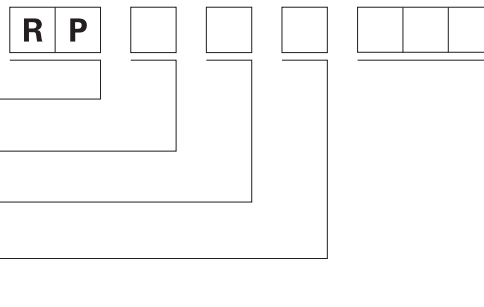

Product key	Version	Contacts	Contact material	Coil	Part number		
RP420005	flux proof	2 C/O contacts	AgCdO	5 Vdc	4-1393234-7		
RP420006	8 A			6 Vdc	4-1393234-8		
RP420012				12 Vdc	5-1393234-0		
RP420024				24 Vdc	5-1393234-1		
RP420048				48 Vdc	5-1393234-2		
RP420110				110 Vdc	5-1393234-4		
RP421012				AgNi 0.15	12 Vdc	6-1393234-7	
RP421024					24 Vdc	6-1393234-8	
RP421048					48 Vdc	6-1393234-9	
RP421060					60 Vdc	7-1393234-0	
RP421110		110 Vdc	7-1393234-1				
RP440012		2 N/O contacts	AgCdO	12 Vdc	7-1393234-8		
RP440024				24 Vdc	7-1393234-9		
RP820006	wash tight	2 C/O contacts	AgCdO	6 Vdc	8-1393234-8		
RP820012	8 A			12 Vdc	9-1393234-0		
RP820024				24 Vdc	9-1393234-2		
RP820048				48 Vdc	9-1393234-3		
RP821012				AgNi 0.15	12 Vdc	0-1393845-4	
RP821024					24 Vdc	0-1393845-5	
RP840024					2 N/O contacts	AgCdO	1-1393845-8
RP841024						AgNi 0.15	24 Vdc

Power PCB Relay Card E

1 pole 8 A



Features

- 1 C/O or 1 N/O contact
- 4 kV coil-contact
- Vertical and horizontal version
- Version with twin contacts
- Wash tight

Applications

I/O modules, heating control, timers

F0151-B



Technical data of approved types on request

Contact data

Configuration	1 C/O contact or 1 N/O contact
Type of contact	standard: single contact
Rated current	8 A / 5 A with AgNi 0.15
Rated voltage / max.breaking voltage AC	250 Vac / 440 Vac
Maximum breaking capacity AC	2000 VA
Make current (max. 4 s at duty cycle 10%)	15 A
Contact material	AgCdO, AgNi 20, AgNi 0.15

Contact ratings

Type	Load	Operations
-A102	4 A, 30 Vdc, resistive	2x10 ⁶
-A102	1 A, 24 Vdc, inductive L / R=40ms	2x10 ⁵
-A402	1 A, 230 Vac, cosφ=0.4	5x10 ⁵

Coil data

Nominal voltage	6...60 Vdc
Nominal coil power	450...500 mW
Operate power	240 mW

Coil versions

Coil code	Nominal voltage Vdc	Pull-in voltage Vdc	Release voltage Vdc	Maximum voltage Vdc	Coil resistance Ω	Coil current mA
001	6	4.0	0.6	10.6	80±10%	75.0
002	12	8.0	1.2	21.5	330±10%	36.4
006	24	16.0	2.4	40.0	1200±15%	20.0
013	48	32.0	4.8	79.0	4700±15%	10.2
023	60	40.0	6.0	98.0	7200±15%	8.3

All figures are given for coil without preenergization, at ambient temperature +20°C
Other coil voltages on request

Max. DC load breaking capacity

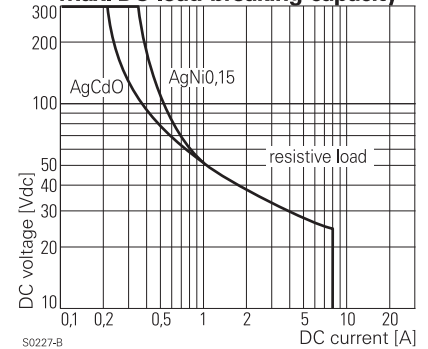

S0227-B

Electrical endurance

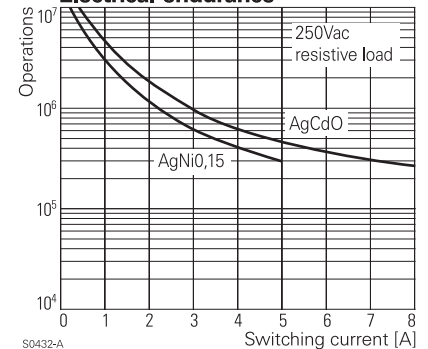

S0432-A

Coil operating range DC

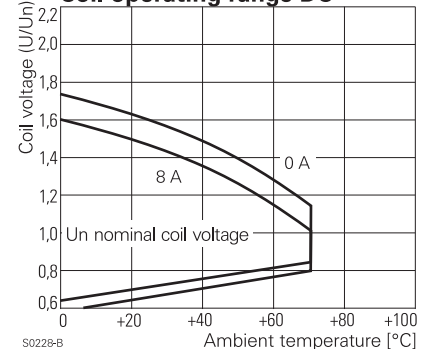

S0228-B

Power PCB Relay Card E

1 pole 8 A

Insulation		
Dielectric strength	coil-contacts	4000 V _{rms}
	open contact circuit	1000 V _{rms}
Clearance / creepage		4 / 4 mm
Insulation to IEC 60664		
Voltage rating		250 V
Pollution degree		3
Overvoltage category		III
Insulation to VDE 0110b (2/79)		
Insulation category / reference voltage		C / 250
Tracking resistance of relay base		CTI 250

Other data	
Flammability class according to UL 94	V-0
Ambient temperature	-40...+70 °C
Mechanical life	approx. 20x10 ⁶ operations
Max. switching rate at rated- / minimum load	6 min ⁻¹ / 20 s ⁻¹
Operate- / release time	7 / 3 ms
Bounce time N/O contact/N/C contact	0.5 / 3 ms
Category of protection (IEC 61810)	RT III - wash tight
Relay weight	14 g
Packaging unit	20 / 400 pcs.
Accessories	see accessories E

Dimensions

Dimensions in mm

Vertical version

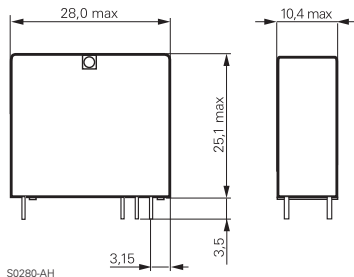

Horizontal version

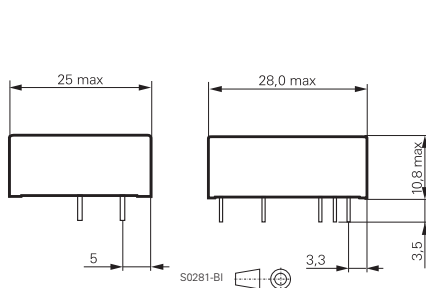

PCB layout / terminal assignment

Vertical version

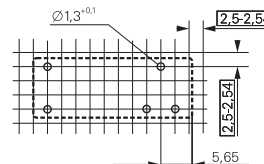

S0257-AH

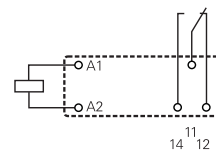

S0257-AB

Horizontal version

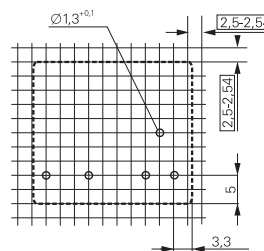

S0257-AI

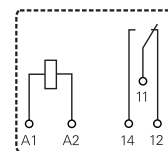

S0257-AE

View on solder pins
Dimensions in mm

Product key

V 2 3 0 5 7 - 0 - - -

Type

Version

A horizontal **B** vertical

Version

0 standard

Coil

001 6 V **013** 48 V
002 12 V **023** 60 V
006 24 V

Contact type

A single contact **B** bifurcated contact (C/O only)

Contact material

1 AgNi0,15 **4** AgCdO
2 AgNi20

Contact configuration

01 1 C/O contact **02** 1 N/O contact

Other types on request

Power PCB Relay Card E

1 pole 8 A

Product key	Version	Cont.type	Cont.material	Cont.config.	Coil	Part number
V23057-A0002-A101	horizontal	single contact	AgNi 0.15	1 C/O contact	12 Vdc	0-1393215-4
V23057-A0002-A401			AgCdO			0-1393215-9
V23057-A0006-A101			AgNi 0.15	24 Vdc	2-1393215-1	
V23057-A0006-A401			AgCdO		2-1393215-5	
V23057-A0006-A402				1 N/O cont.	2-1393215-7	
V23057-A0013-A101			AgNi 0.15	1 C/O contact	48 Vdc	3-1393215-8
V23057-A0013-A401			AgCdO			4-1393215-0
V23057-A0023-A101			AgNi 0.15	60 Vdc	5-1393215-5	
V23057-A0023-A401			AgCdO			5-1393215-6
V23057-B0002-A101			vertical	single contact	AgNi 0.15	12 Vdc
V23057-B0002-A401	AgCdO	7-1393215-1				
V23057-B0002-A402		1 N/O cont.			7-1393215-2	
V23057-B0006-A101	AgNi 0.15	24 Vdc			7-1393215-5	
V23057-B0006-A102						1 C/O cont.
V23057-B0006-A102		1 N/O cont.			7-1393215-9	
V23057-B0006-A401	AgCdO	1 C/O cont.			8-1393215-5	
V23057-B0006-A402		1 N/O cont.			8-1393215-6	
V23057-B0013-A101	AgNi 0.15	48 Vdc			9-1393215-4	
V23057-B0013-A401	AgCdO					9-1393215-6
V23057-B0023-A101	AgNi 0.15	60 Vdc	0-1393216-5			
V23057-B0023-A401	AgCdO			0-1393216-6		

Power PCB Relay U/UB

1 pole 7 A, mono or bistable

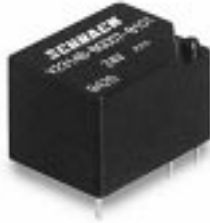

F0153-B

Features

- 1 C/O or 1 N/O or 1 N/C contact
- Bistable and DC-version
- Standard version with 230 mW pull-in power
- Sensitive version with 180 mW pull-in power
- Wash tight version
- Version for 10 A on request

Applications

Heating control, installation, battery powered equipment



Technical data of approved types on request

Contact data

Configuration	1 C/O, 1 N/O or 1 N/C contact
Type of contact	single contact
Rated current	7 A standard and bistable 5 A sensitive
Rated voltage / max.breaking voltage AC	250 Vac / 250 Vac
Maximum breaking capacity AC	1750 VA standard and bistable 1250 VA sensitive
Make current (max. 4 s at duty cycle 10%)	12 A
Contact material	AgNi 10

Contact ratings

Type	Load	Operations
standard and bistable	7 A, 24 Vdc, resistive	5x10 ⁴
sensitive	5 A, 24 Vdc, resistive	3x10 ⁴
standard and bistable	7 A, 250 Vac, resistive	5x10 ⁴
standard	5 A, 250 Vac, resistive	1.5x10 ⁵
sensitive	5 A, 250 Vac, resistive	1x10 ⁵
bistable	5 A, 250 Vac, resistive	1x10 ⁵

Coil data

	monostable	sensitive
Nominal voltage	6...48 Vdc	
Nominal coil power	3..24 Vdc	450 mW
	48 Vdc	610 mW
Operate category	1 / a	

Coil versions, monostable

Coil code	Nominal voltage Vdc	Pull-in voltage Vdc	Release voltage Vdc	Maximum voltage Vdc	Coil resistance Ω	Coil current mA
standard						
003	6	4.2	0.6	10.5	80±10%	75.0
005	12	8.4	1.2	21.1	320±10%	37.5
007	24	16.8	2.4	42.2	1280±10%	18.8
008	48	33.6	4.8	72.4	3800±10%	12.6
sensitive						
103	6	4.4	0.6	12.6	110±10%	54.6
105	12	8.8	1.2	25.3	440±10%	27.3
107	24	17.5	2.4	50.6	1780±10%	13.5
108	48	35.0	4.8	76.3	4000±10%	12.0

All figures are given for coil without preenergization, at ambient temperature +20°C Other coil voltages on request

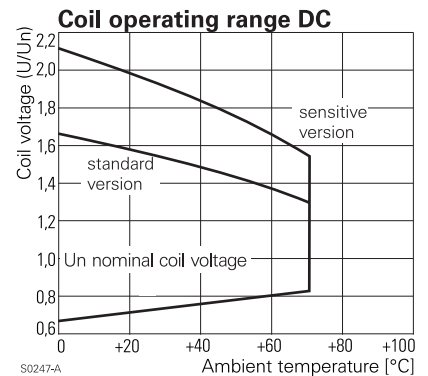
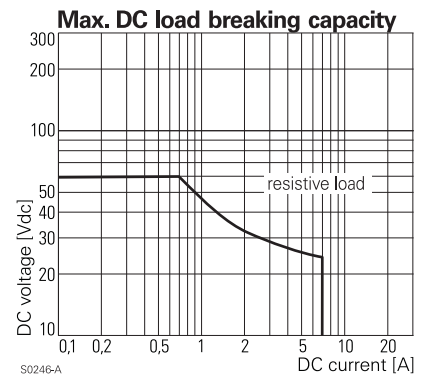

Power PCB Relay U/UB

1 pole 7 A, mono or bistable

Coil data	bistable
Nominal voltage	6...48 Vdc
Operate power	600...800 mW
Nominal energization power / -time	900...1300 mW / 20 ms
Reset voltage min.	25 % U_{nom}
Reset voltage max.	45 % U_{nom}

Bistable coil versions

Coil code	Nominal voltage Vdc	Pull-in voltage Vdc	Reset voltage Vdc	Maximum voltage Vdc	Coil resistance Ω	Coil current mA
003	6	4.7	1.5	6.2	$33 \pm 10\%$	181.8
005	12	9.4	3.0	12.4	$119 \pm 10\%$	100.8
007	24	18.7	6.0	24.7	$475 \pm 10\%$	50.5
008	48	37.4	12.0	49.4	$1750 \pm 10\%$	27.4

All figures are given for coil without preenergization, at ambient temperature +20°C

Other coil voltages on request

Insulation

Dielectric strength	coil-contacts	2000 V_{rms} version V23148-*0*** 4000 V_{rms} version V23148-*1***
	open contact circuit	1000 V_{rms}
Surge voltage resistance	coil-contacts	5000 V_{rms}
Clearance / creepage		2.5 / 2.5 mm version V23148-*0*** 3.5 / 3.5 mm version V23148-*1***
	Insulation to VDE 0110b (2/79)	
Insulation category / reference voltage		B / 250 open contact circuit B / 125 contact/coil
	Tracking resistance of relay base	CTI 250

Other data

Flammability class according to UL 94	V-0	
Ambient temperature	-25...+70 °C	
Mechanical life	20×10^6 operations	
Max. switching rate at rated- / minimum load	$300 \text{ min}^{-1} / 10 \text{ min}^{-1}$	
Operate- / release time	standard	6 / 3 ms
	sensitive	7 / 3 ms
Operate- / reset time	5 / 3 ms	
Bounce time N/O contact/N/C contact	2 / 10 ms	
Vibration resistance	10 g, 10...55 Hz	
Shock resistance (function)	10 g at 11 ms half sine	
Category of protection (IEC 61810)	RT III - wash tight	
Relay weight	9.5 g	
Packaging unit	25 / 500 pcs.	

Dimensions

Dimensions in mm

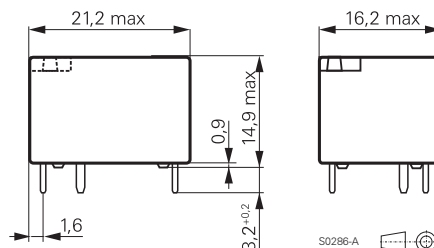

PCB layout / terminal assignment

View on solder pins
Dimensions in mm

Monostable and bistable 1 coil

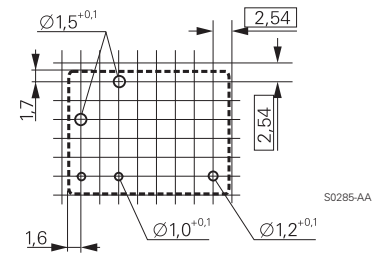

C/O contact

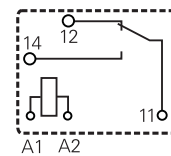

N/O contact

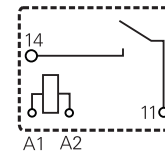

N/C contact

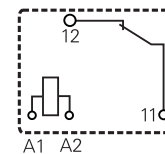

Low Profile PCB Relay PCD

1 pole 10 A



F0154-B

Features

- 1 N/O contact
- Low coil power 200 mW
- Height 10.2 mm
- Wash tight

Applications

Domestic appliances, coffee machines, irons, office equipment



Technical data of approved types on request

Contact data

Configuration	1 N/O contact
Type of contact	single contact
Rated current	10 A
Continuous thermal load	15 A
Rated voltage / max.breaking voltage AC	250 Vac / 250 Vac
Maximum breaking capacity AC	2500 VA
Contact material	AgCdO

Contact ratings

Load	Operations
Rated load	1x10 ⁵

Coil data

Nominal voltage	6...24 Vdc
Nominal coil power	approx. 200 mW

Coil versions

Coil code	Nominal voltage Vdc	Pull-in voltage Vdc	Release voltage Vdc	Maximum voltage Vdc	Coil resistance Ω	Coil current mA
006	6	4.5	0.3	7.8	180±10%	33.3
012	12	9.0	0.6	15.6	720±10%	16.7
024	24	18.0	1.2	31.2	2880±10%	8.3

All figures are given for coil without preenergization, at ambient temperature +20°C
Other coil voltages on request

Insulation

Dielectric strength	coil-contacts	2500 V _{rms}
	open contact circuit	750 V _{rms}
Clearance / creepage		4 mm
Insulation to IEC 60664		
Voltage rating		250 V
Pollution degree		3
Overvoltage category		III
Insulation to VDE 0110b (2/79)		
Insulation category / reference voltage		C / 250

Electrical endurance

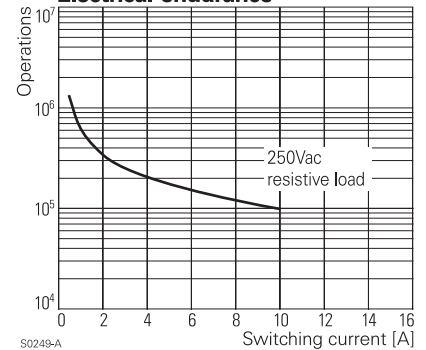

Coil operating range DC

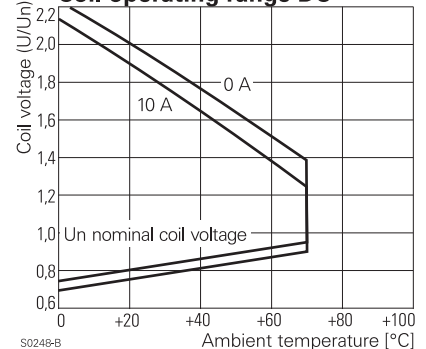

Low Profile PCB Relay PCD

1 pole 10 A

Other data

Ambient temperature	-30...+70 °C
Mechanical life	>10x10 ⁶ operations
Max. switching rate at rated- / minimum load	10 min ⁻¹ / 300 min ⁻¹
Operate- / release time	8 / 2 ms
Vibration resistance	1.5 mm sine, 10...55 Hz
Shock resistance (function)	10 g
Shock resistance (destruction)	100 g
Category of protection (IEC 61810)	RT II - flux proof, RT III - wash tight
Relay weight	9 g
Packaging unit	1000 pcs.

PCB layout / terminal assignment

View on solder pins

Dimensions in mm

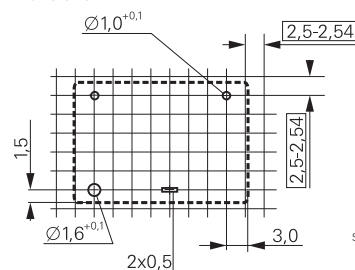

S0259-AA

Dimensions

Dimensions in mm

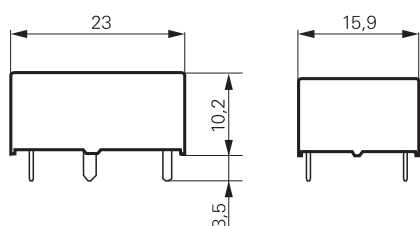

S0287-A

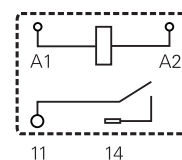

S0259-AB

Product key

P C D **1** **D** **1** **M**

Type

Number of contacts

1 1 N/O contact

Coil

6 6 V

12 12 V

24 24 V

Coil version

D standard 200 mW

Contact material

1 AgCdO

Contact configuration

M N/O contact

Version

- flux proof

H wash tight

Other types on request

Product key	Version	Cont-material	Cont.configuration	Coil	Part number
PCD-105-D1MH	standard 200mW	AgCdO	1 N/O contact	5 Vdc	3-1419126-6
PCD-112-D1MH	washable			12 Vdc	4-1419126-2
PCD-124-D1MH				24 Vdc	4-1419126-8
PCD-148-D1MH				48 Vdc	0-1419146-7

Miniature Power PCB Relay PB

1pole 10 A



Features

- 1 C/O or 1 N/O contact
- Environmentally-friendly cadmium-free contacts
- Creepage/clearance to VDE 0435 and VDE 0700
- Class F coil available
- Compact and simple design gives high process security

Applications

White goods, small home appliances, heating temperature controllers

F0224-A



Technical data of approvals on request

Contact data

Configuration	1 C/O contact or 1 N/O contact
Type of contact	single contact
Rated current	C/O version: N/O 10 A; N/C 3 A N/O version: 10 A
Continuous thermal load	10 A
Maximum switching voltage	250 Vac / 100 Vdc
Maximum breaking capacity AC	2500 VA
Make current (max. 4 s at duty cycle 10%)	15 A
Contact material	AgNi 90/10

Contact ratings

Type	Load	Operations
N/O contact	10 A, 85 °C	25x10 ³
N/O contact	6 A, 85 °C	100x10 ³
C/O contact	10 A / 3 A, 85 °C	25x10 ³
C/O contact	10 A / 10 A, 85 °C	1x10 ³

Coil data

Nominal voltage	5, 6, 12, 24 Vdc
Nominal coil power	360 mW
Operate power	200 mW
Operate category	2 / c
Operate voltage max.	75 % U _{nom}
Non-release voltage	50 % U _{nom}
Release voltage min.	10 % U _{nom}

Coil versions, DC-coil

Coil code	Nominal voltage Vdc	Pull-in voltage Vdc	Release voltage Vdc	Coil resistance Ω	Coil current mA
006	6	4.5	0.6	100±10%	60.0
012	12	9	1.2	400±10%	30.0
024	24	18	2.4	1600±10%	15.0

All figures are given for coil without preenergization, at ambient temperature +20°C
Other coil voltages on request

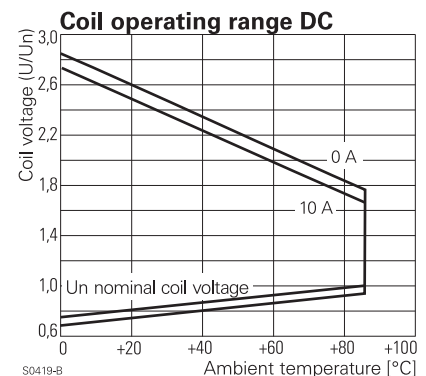
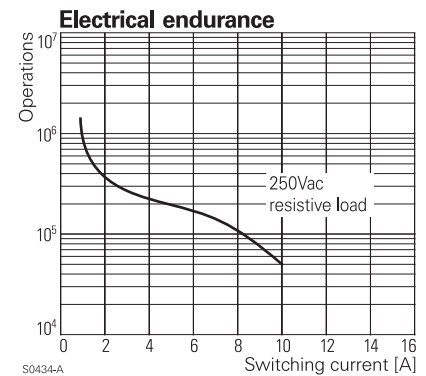
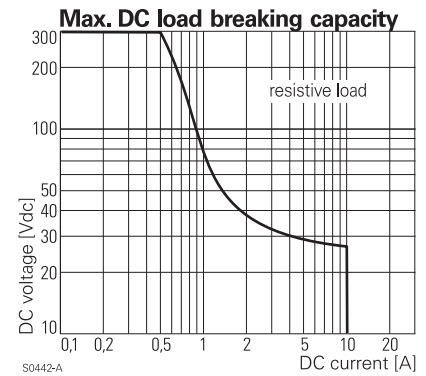

Miniature Power PCB Relay PB

1pole 10 A

Insulation		
Dielectric strength	coil-contacts	2500 V _{rms}
	open contact circuit	1000 V _{rms}
Surge voltage resistance coil-contacts		4000 V _{rms}
Clearance / creepage		3 / 4 mm
Insulation to IEC 60664		
Voltage rating		250 V
Pollution degree		3
Overvoltage category		III
Insulation to VDE 0110b (2/79)		
Insulation category / reference voltage		C / 250
Insulation resistance		100x10 ⁶
Tracking resistance of relay base		PB1...CTI 250 PB3...CTI 300

Other data	
Flammability class according to UL 94	V-0
Coil insulation system according to UL 1446	Class F
Ambient temperature	-40...+85 °C (105 °C)
Mechanical life	> 5x10 ⁶ operations
Max. switching rate at rated- / minimum load	60 min ⁻¹ / 600 min ⁻¹
Operate- / release time	< 20 ms
Bounce time	< 15 ms
Vibration resistance 30...400 Hz	>4 g
Shock resistance (destruction)	>30 g
Category of protection (IEC 61810)	RT II - flux proof
Relay weight	5.4 g
Soldering temperature / time, IEC 68-2-20	max. 260 °C / 5s
Packaging unit	35 / 1050 pcs.

PCB layout / terminal assignment

View on solder pins
Dimensions in mm

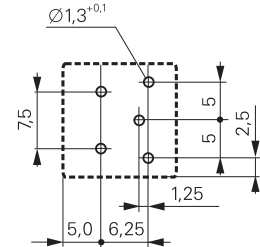

S0407-AA

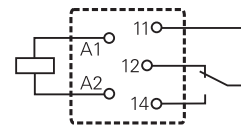

S0407-AB

Dimensions

Dimensions in mm

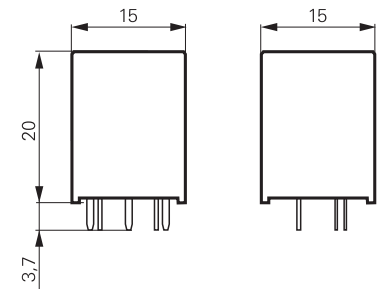

S0406-A

Product key

Type

Version

- 1** standard version, CTI 250
- 3** high CTI version, CTI 300

Contacts

- 1** 1 C/O contact
- 3** 1 N/O contact

Contact material

- 4** AgNi 90/10

Coil

Coil code: please refer to coil versions table

Other types on request

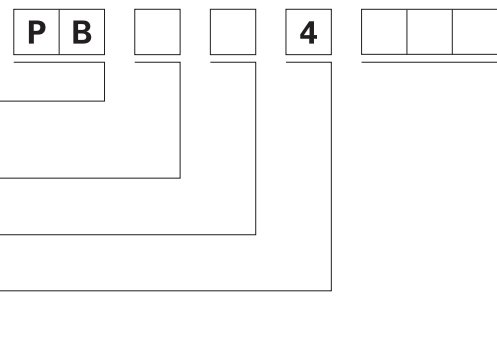

Product key	Version	Contacts	Contact material	Coil	Part number	
PB114005	standard CTI 250	1 C/O contact	AgNi 90/10	5 Vdc	6-1415029-1	
PB114006				6 Vdc	7-1415029-1	
PB114012				12 Vdc	8-1415029-1	
PB114024				24 Vdc	9-1415029-1	
PB134005	high CTI version CTI 300	1 N/O contact	AgNi 90/10	5 Vdc	0-1415030-1	
PB134006				6 Vdc	1-1415030-1	
PB134012				12 Vdc	2-1415030-1	
PB134024				24 Vdc	3-1415030-1	
PB314005		1 C/O contact		1 C/O contact	5 Vdc	4-1415030-1
PB314006					6 Vdc	5-1415030-1
PB314012					12 Vdc	6-1415030-1
PB314024					24 Vdc	7-1415030-1
PB334005	1 N/O contact	1 N/O contact	AgNi 90/10	5 Vdc	8-1415030-1	
PB334006				6 Vdc	9-1415030-1	
PB334012				12 Vdc	0-1415031-1	
PB334024				24 Vdc	1-1415031-1	

Miniature Power PCB Relay PBH 105°C

1pole 6 A



Features

- 1 C/O or 1 N/O contact
- Environmentally-friendly cadmium-free contacts
- Creepage/clearance to VDE 0435 and VDE 0700
- Class F coil standard
- For ambient temperatures up to 105°C

Applications

White goods, domestic appliances

F0224-BBC



Technical data of approvals on request

Contact data

Configuration	1 C/O contact or 1 N/O contact
Type of contact	single contact
Rated current	6 A (mounting distance 3 mm) 4 A (closely packed)
Continuous thermal load to 105°C	6 A
Maximum switching voltage	250 Vac
Maximum breaking capacity AC	1500 VA
Contact material	AgNi 90/10

Contact ratings

Type	Load	Operations
N/O contact	2 A, 240 Vac, 105°C	250x10 ³
N/O contact	5 A, 250 Vac, 105°C	150x10 ³
N/O contact	6 A, 250 Vac, 105°C	100x10 ³

Coil data

Nominal voltage	5...36 Vdc
Nominal coil power	360 mW
Operate power	200 mW
Operate category	90...100 % U _{nom}
Non-release voltage.	50 % U _{nom}
Release voltage min.	10 % U _{nom}

Coil versions, DC-coil

Coil code	Nominal voltage Vdc	Pull-in voltage Vdc	Release voltage Vdc	Coil resistance Ω	Coil current mA
005	5	3.75	0.5	70±10%	72.0
006	6	4.5	0.6	100±10%	60.0
009	9	6.75	0.9	225±10%	40.0
012	12	9.0	1.2	400±10%	30.0
024	24	18.0	2.4	1600±10%	15.0
036	36	27.0	3.6	3600±10%	10.0

All figures are given for coil without preenergization, at ambient temperature +20°C

Other coil voltages on request

Miniature Power PCB Relay PBH 105°C

1pole 6 A

Insulation		
Dielectric strength	coil-contacts	2500 V _{rms}
	open contact circuit	1000 V _{rms}
Surge voltage resistance coil-contacts		4000 V _{rms} (1.2 / 50µs)
Clearance / creepage		3 / 4 mm
Insulation to IEC 60664		
Voltage rating		250 V
Pollution degree		3
Overvoltage category		III
Insulation to VDE 0110b (2/79)		
Insulation category / reference voltage		C / 250
Insulation resistance		100x10 ⁶ Ω
Tracking resistance of relay base		> CTI 250

Other data	
Flammability class according to UL 94	V-0
Coil insulation system according to UL 1446	Class F
Ambient temperature	-20...+105 °C
Mechanical life	> 2x10 ⁶ operations
Max. switching rate at rated- / minimum load	60 min ⁻¹ / 600 min ⁻¹
Operate- / release time max.	< 20 ms
Bounce time N/O contact / N/C contact typ.	< 15 ms
Vibration resistance 30...400 Hz	> 4 g
Shock resistance (destruction)	> 30 g
Category of protection (IEC 61810)	RT II - flux proof
Relay weight	5.4 g
Soldering temperature / time, IEC 68-2-20	max. 260 °C / 5s
Packaging unit	35 / 1050 pcs.

PCB layout / terminal assignment

View on solder pins
Dimensions in mm

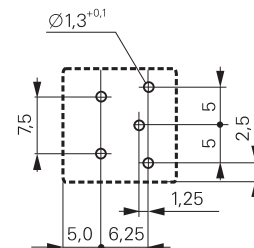

S0407-AA

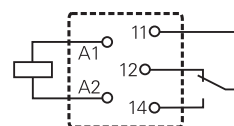

S0407-AB

Dimensions

Dimensions in mm

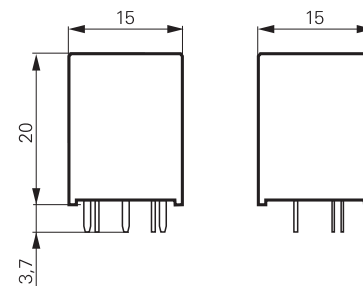

S0406-A

Product key

Type

Version

H High temperature version

Contacts

1 1 C/O contact **3** 1 N/O contact

Contact material

4 AgNi 90/10

Coil

Coil code: please refer to coil versions table

Other types on request

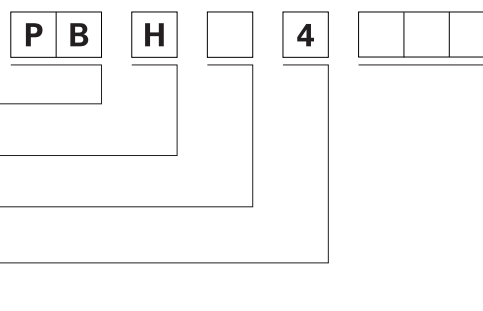

Product key	Version	Contacts	Contact material	Coil	Part number
PBH14005	high	1 C/O contact	AgNi 90/10	5 Vdc	9-1415356-1
PBH14006	temperature			6 Vdc	8-1415356-1
PBH14009	version			9 Vdc	7-1415356-1
PBH14012				12 Vdc	6-1415356-1
PBH14024				24 Vdc	6-1415355-1
PBH34005		1 N/O contact		5 Vdc	5-1415356-1
PBH34006				6 Vdc	4-1415356-1
PBH34009				9 Vdc	3-1415356-1
PBH34012				12 Vdc	2-1415356-1
PBH34024				24 Vdc	1-1415356-1

Miniature Power PCB Relay T7N / T7N-WG

1pole 10A



F0189-B

Features

- 1C/O or 1N/O contact
- Creepage/clearance to VDE 0435 and VDE 0700
- Sensitive 360mW coil available
- Creepage/clearance to VDE 0435
- Version T7N-WG with tracking resistance CTI 325

Applications

Domestic appliances, heating control, building control, measurement&control

T7N: 

T7N-WG: 

Technical data of approved types on request

Contact data	T7N	T7N-WG
Configuration	1 C/O contact or 1 N/O contact	
Type of contact	single contact	
Rated current N/O contact / N/C contact	10 / 5 A	
Continuous thermal load	10 A	
Rated voltage / max.breaking voltage AC	250 Vac / 250 Vac	
Maximum breaking capacity AC	2500 VA	
Make current (max. 4 s at duty cycle 10%)	35 A	
Contact material	AgCdO, AgSnO ₂	AgCdO

Contact ratings

Type	Load	Operations
AgCdO	10 A, 240 Vac	100x10 ³
AgCdO	5 A, 240 Vac, resistive	2x10 ⁵
AgCdO	2 A, 120 Vac, cosφ=0.5, 60 °C	1.4x10 ⁶

Coil data	T7N standard	T7N-WG	T7N-WG sensitive
Nominal voltage	6...48 Vdc	6...36 Vdc	6...36 Vdc
Nominal coil power	360 mW	450 mW	360 mW
Operate power	176 mW	253 mW	176 mW
Operate category	1 / c	2 / b	2 / b
Operate voltage max.	70 % U _{nom}	70 % U _{nom}	70 % U _{nom}
Non-release voltage	50 % U _{nom}	50 % U _{nom}	50 % U _{nom}
Release voltage min.	10 % U _{nom}	10 % U _{nom}	10 % U _{nom}

Coil versions

Coil code	Nominal voltage Vdc	Pull-in voltage Vdc	Release voltage Vdc	Maximum voltage Vdc	Coil resistance Ω	Coil current mA
version T7N-WG						
12	12	8.4	1.2	25.0	320±10%	37.5
24	24	16.8	2.4	50.0	1280±10%	18.8
36	36	25.2	3.6	73.0	2880±10%	12.5
version T7N standard and T7N-WG sensitive						
06	6	4.2	0.6	12.5	100±10%	60.0
12	12	8.4	1.2	25.0	400±10%	30.0
24	24	16.8	2.4	50.0	1600±10%	15.0
36	36	25.2	3.6	73.0	3600±10%	10.0
48	48	33.6	4.8	100.0	6400±10%	7.0

All figures are given for coil without preenergization, at ambient temperature +20°C
Other coil voltages on request

Max. DC load breaking capacity

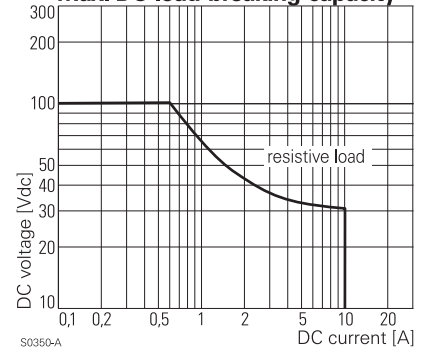

S0350-A

Electrical endurance

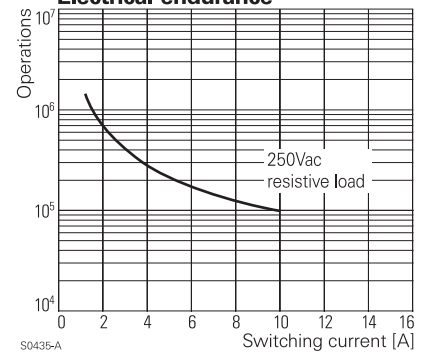

S0435-A

Coil operating range DC

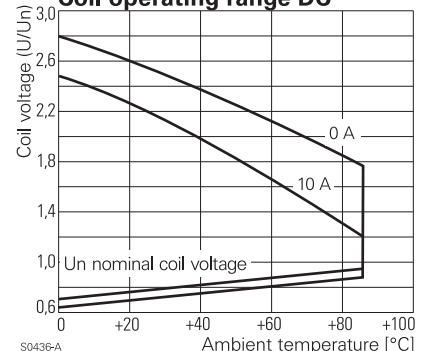

S0436-A

Miniature Power PCB Relay T7N / T7N-WG

1pole 10A

Insulation	T7N	T7N-WG
Dielectric strength	coil-contacts open contact circuit	2000 V _{rms} 1000 V _{rms}
Surge voltage resistance	coil-contacts 4000 V _{rms} (1.2 / 50µs)	
Clearance / creepage	2 / 3 mm	3 / 4 mm
Insulation to IEC 60664		
Voltage rating	250 V	
Pollution degree	3	
Overvoltage category	III	
Insulation to VDE 0110b (2/79)		
Insulation category / reference voltage	C / 250	
Insulation resistance	100x10 ⁶ Ω	
Tracking resistance of relay base	CTI 225	CTI 325

Other data	
Flammability class according to UL 94	V-0
Ambient temperature	-40...+85 °C (105 °C)
Mechanical life	10x10 ⁶ operations
Max. switching rate at rated- / minimum load	30 min ⁻¹ / 300 min ⁻¹
Operate- / release time	10 / 5 ms
Bounce time N/O contact / N/C contact	0.6 / 17 ms
Vibration resistance	>10 g
Shock resistance (function)	>10 g
Shock resistance (destruction)	>100 g
Category of protection (IEC 61810)	RT III - wash tight
Relay weight	11 g
Packaging unit	500 pcs.

PCB layout / terminal assignment

View on solder pins
Dimensions in mm

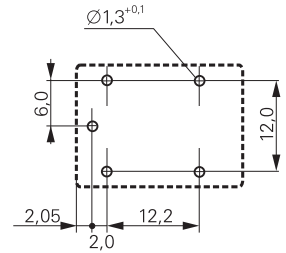

S0260-AA

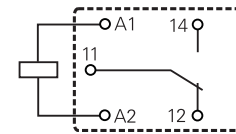

S0260-AB

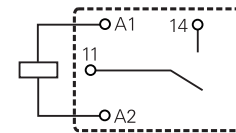

S0260-AC

Dimensions

Dimensions in mm

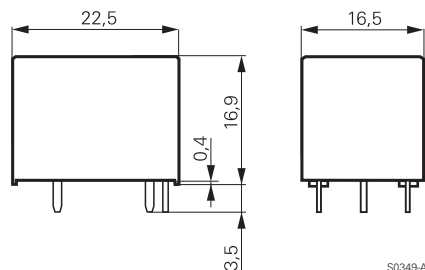

S0349-A

Product key



Type

Version

S wash tight

Contacts

1 1 N/O contact

5 1 C/O contact

Coil version

H DC coil 450mW

D DC coil 360mW

Contact material

1 AgCdO

4 AgSnO₂ (T7N standard version only)

Coil

coil code: please refer to coil versions table

Version

Blank

T7N standard version

WG-A

version for domestic appliances

Other types on request

Miniature Power PCB Relay T7N / T7N-WG

1pole 10A

Product key	Version	Cont-material	Cont.configuration	Coil	Part number
T7N S1D1-06	wash tight CTI 225	AgCdO	1 N/O contact	6 Vdc	0-1393186-3
T7N S1D1-12				12 Vdc	5-1440006-4
T7N S1D1-24				24 Vdc	5-1440006-6
T7N S1D1-48				48 Vdc	5-1440006-8
T7N S1D4-06		AgSnO		6 Vdc	6-1440005-2
T7N S1D4-12				12 Vdc	7-1440006-2
T7N S1D4-24				24 Vdc	7-1440006-4
T7N S1D4-48				48 Vdc	7-1440006-6
T7N S5D1-06		AgCdO	1 C/O contact	6 Vdc	4-1440006-2
T7N S5D1-12				12 Vdc	4-1440006-4
T7N S5D1-24				24 Vdc	4-1440006-7
T7N S5D1-48				48 Vdc	4-1440006-9
T7N S5D4-06		AgSnO		6 Vdc	6-1440006-1
T7N S5D4-12				12 Vdc	6-1440006-3
T7N S5D4-24				24 Vdc	6-1440006-5
T7N S5D4-48				48 Vdc	6-1440006-7
T7NS5H1-06-WG-A	wash tight CTI 325	AgCdO		6 Vdc	7-1440006-9
T7NS5H1-12-WG-A				12 Vdc	8-1440006-0
T7NS5H1-24-WG-A				24 Vdc	8-1440006-2
T7NS5H1-36-WG-A				36 Vdc	8-1440006-3
T7NS5H1-48-WG-A				48 Vdc	8-1440006-4

Power Relay T9A

1 pole 30 A



F0156-A



F0179-A

Features

- 1 N/O or 1 C/O contact
- High breaking capacity 7500 VA
- PCB- and PCB/Faston connections
- Chassis mount version with faston terminals
- UL-class F as standard
- Ambient temperature 85°C
- Open version available

Applications

HVAC, power supplies, domestic appliances, measurement&control



Technical data of approved types on request

Contact data

Configuration	1 C/O contact	1 N/O contact
Type of contact	single contact	
Rated current on the N/O- N/C contact	20 A / 10 A	25 A
Rated voltage / max.breaking voltage AC	240 Vac / 250 Vac	
Maximum breaking capacity AC	4800 VA	7200 VA
Contact material	AgCdO	
Minimum contact load	1 A, 5 Vdc / 12 Vac	

Contact ratings

Type	Load	Operations	Standard
N/O contact	2 hp, 240 Vac, motor	6x10 ³	UL 508
N/O contact	5.4 A, 240 Vac, halogen	6x10 ³	UL 508
N/O contact	25 A, 240 Vac, resistive	1x10 ⁵	
C/O contact	10 / 10 A, 240 Vac, resistive	1x10 ⁵	
C/O contact	20 / 10 A, 28 Vdc, resistive	1x10 ⁵	

Coil data

Nominal voltage	6...48 Vdc
Nominal coil power	1 W

Coil versions

Coil code	Nominal voltage Vdc	Pull-in voltage Vdc	Release voltage Vdc	Maximum voltage Vdc	Coil resistance Ω	Coil current mA
6	6	4.5	0.6	10.0	36±10%	166.7
12	12	9.0	1.2	20.1	144±10%	83.3
24	24	18.0	2.4	40.2	576±10%	41.7
48	48	36.0	4.8	80.3	2304±10%	20.8

All figures are given for coil without preenergization, at ambient temperature +20°C

Other coil voltages on request

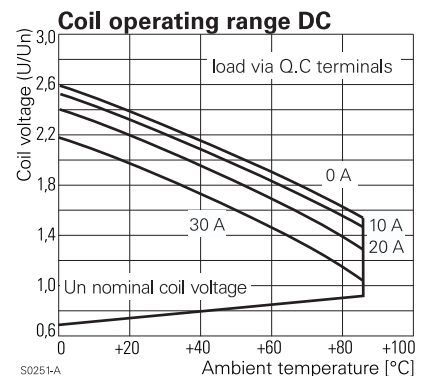
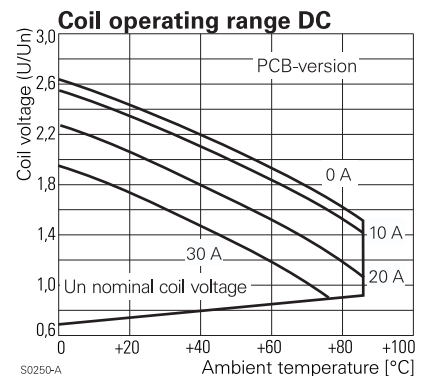

Power Relay T9A

1 pole 30 A

Product key

T	9	A			D		2		
---	---	---	--	--	---	--	---	--	--

Type

Enclosure

- P** dust protected (flange mount)
- S** wash tight (PCB- or PCB-/Faston-version)

Contact configuration

- 1** N/O contact
- 5** C/O contact

Coil version

- D** DC coil 1 Watt

Mounting

- 1** PCB-version
- 2** PCB-terminals for coil and contacts, Faston terminals for contacts
- 5** Flange mount, 4.75 Faston terminals for coil, 6.35 Faston terminal for contacts

Contact material

- 2** AgCdO

Coil

Coil code: please refer to coil versions table

Other types on request

Product key	Version	Cont-material	Cont.configuration	Coil	Part number
T9AS1D12-12	pcb-version	AgCdO	1 N/O contact	12 Vdc	1-1393210-3
T9AS1D12-18	wash tight			18 Vdc	1-1393210-5
T9AS1D22-12	pcb terminals			12 Vdc	1-1419104-7
T9AS1D22-24	Faston terminals			24 Vdc	2-1419104-1
T9AS5D22-12	for contacts		1 C/O contact	12 Vdc	3-1419104-3
T9AS5D22-24	wash tight			24 Vdc	3-1419104-6

Power Relay T92

2 pole 30 A, DC- and AC-coil



F0167-A

Features

- 2 C/O or 2 N/O contacts
- Switching capacity 7500 VA (2 N/O)
- DC- or AC coil
- 4 kV / 8 mm coil-contact
- Insulation to VDE 0631 and VDE 0700
- PCB- or Faston connections or chassis mount
- Adapter for DIN-rail mounting

Applications

Power supplies, heating & ventilation, control equipment



Technical data of approved types on request

Contact data

Configuration	2 C/O contact or 2 N/O contact
Type of contact	single contact
Rated current N/O contact/N/C contact	30 / 3 A
Rated voltage / max.breaking voltage AC	250 Vac / 440 Vac
Maximum breaking capacity AC	7500 VA
Contact material	AgCdO
Minimum contact load	500 mA, 12 Vac

Contact ratings

Type	Load	Operations
AC-coil	rated load	1x10 ⁵
DC-coil	rated load	3x10 ⁵

Coil data

Nominal voltage	DC coil	6...48 Vdc
	AC coil	24...240 Vac
Nominal coil power	DC coil	1.7 W
	AC coil	4.0 VA
Operate category		1 / a

DC Coil versions

Coil code	Nominal voltage Vdc	Pull-in voltage Vdc	Release voltage Vdc	Maximum voltage Vdc	Coil resistance Ω	Coil current mA
12	12	9.0	1.2	22.2	86±10%	139.5
24	24	18.0	2.4	44.4	350±10%	68.6

All figures are given for coil without preenergization, at ambient temperature +20°C

Other coil voltages on request

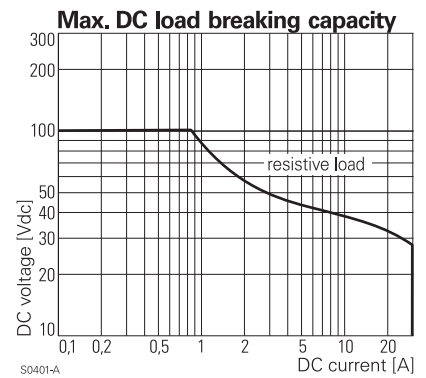

S0401-A

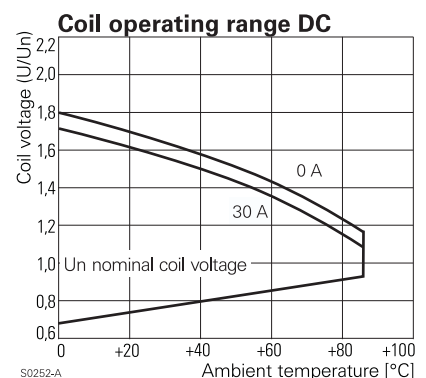

S0252-A

Power Relay T92

2 pole 30 A, DC- and AC-coil

AC Coil versions

Coil code	Nominal voltage Vac	Pull-in voltage Vac	Release voltage Vac	Maximum voltage Vac	DC-Coil resistance Ω
24	24	19.2	2.4	11.1	44 \pm 10%
240	220 / 240	192.0	24.0	22.2	3800 \pm 10%

All figures are given for coil without preenergization, at ambient temperature +20°C
Other coil voltages on request

Insulation

Dielectric strength	coil-contacts	4000 V_{rms}
	open contact circuit	1500 V_{rms}
	adjacent contacts	2000 V_{rms}
Clearance / creepage		8 / 9.5 mm
Insulation to VDE 0110b (2/79)		
Insulation category / reference voltage		C / 380
Tracking resistance of relay base		PTI 100

Other data

Flammability class according to UL 94	V-0
Ambient temperature	DC-coil -40...+85 °C AC-coil -40...+65 °C
Mechanical life	5x10 ⁶ operations
Max. switching rate at rated- / minimum load	14 min ⁻¹
Operate- / release time	15 / 10 ms
Vibration resistance	1.65 mm, 10...55 Hz
Shock resistance (function)	10g, 11 ms half sine
Shock resistance (destruction)	100g, 11 ms half sine
Category of protection (IEC 61810)	RT I - dust protected, RT III - wash tight
Relay weight	86 g
Packaging unit	30 pcs.

Dimensions

Dimensions in mm

PCB version

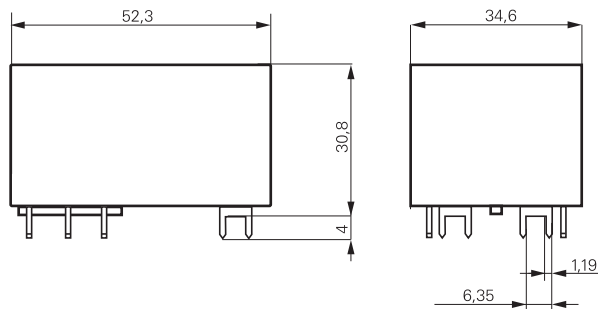

Coil operating range AC

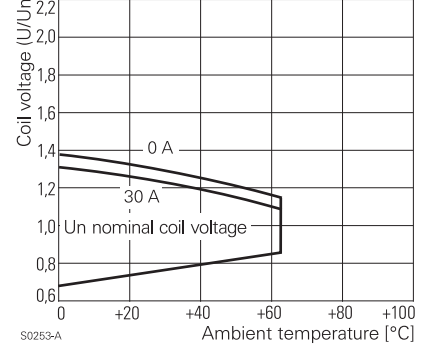

PCB layout / terminal assignment

View on solder pins
Dimensions in mm

PCB version

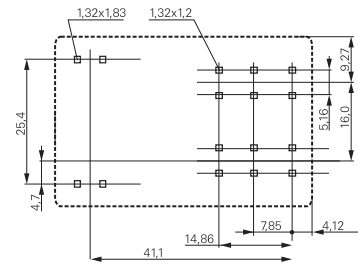

S0262-AA

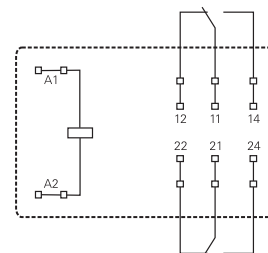

S0262-AB

Power Relay T92

2 pole 30 A, DC- and AC-coil

Dimensions

Dimensions in mm

Flange mount

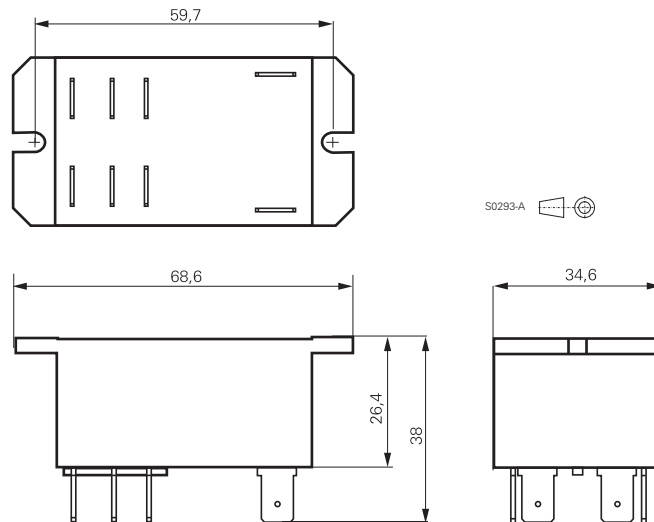

Product key

T 9 2 **2**

Type

Enclosure

P dust protected

S wash tight (PCB version only)

Contact configuration

7 2 N/O contacts

11 2 C/O contacts

Coil version

A AC-coil 50/60 Hz

D DC-coil

Mounting

1 PCB version

2 flange mount, 6.35 Faston terminals for contacts and coil

Contact material

2 AgCdO

Coil

Coil code: please refer to coil versions table

Other types on request

Product key	Version	Mounting	Cont.configuration	Coil	Coil	Part number
T92P7A22-240	dust protected	flange mount	2 N/O contacts	AC-coil	240 Vac	6-1393211-2
T92P7D22-12				DC-coil	12 Vdc	6-1393211-9
T92P7D22-24					24 Vdc	7-1393211-1
T92S11A22-240	wash tight		2 C/O contacts	AC-coil	240 Vac	8-1393211-7
T92S11D12-24		pcb-version		DC-coil	24 Vdc	9-1393211-0
T92S7A12-240			2 N/O contacts	AC-coil	240 Vac	9-1393211-9
T92S7A22-240		flange mount			240 Vac	0-1393212-5
T92S7D12-24		pcb-version		DC-coil	24 Vdc	1-1393212-0

Power Relay 430 3 mm

1 pole 16 A, DC- and AC-coil



F0256-A

Features

- 1 N/O contact
- Safety mains isolation
- Contact gap > 3 mm
- 4 kV / 8 mm coil-contact, protection class II (VDE 0700)
- PCB mounting or Faston connectors
- Mounting brackets or snap mounting
- Version with arc blow magnet for high DC-loads

Applications

Domestic appliances, industrial appliances, industrial controls



Technical data of approved types on request

Contact data

Configuration	1 N/O contact
Type of contact	single contact
Rated current	16 A
Rated voltage / max.breaking voltage AC	250 Vac / 400 Vac
Maximum breaking capacity AC	4000 VA
Make current (max. 4 s at duty cycle 10%)	25 A
Contact material	AgCdO, AgCu3
Contact gap	>3 mm

Contact ratings

Type	Load	Operations
430x5	16 A, 250 Vac, resistive, 70 °C	1.5x10 ⁵
430x5	10 A, 250 Vac, resistive, 105 °C	1.5x10 ⁵

Coil data

Nominal voltage	DC coil	6...110 Vdc
	AC coil	6...240 Vac
Nominal coil power	DC coil	1 W
	AC coil	1.8 VA
Operate category		2 / b

Coil versions, DC coil

Coil code	Nominal voltage Vdc	Pull-in voltage Vdc	Release voltage Vdc	Maximum voltage Vdc	Coil resistance Ω	Coil current mA
09	12	7.8	0.6	15.6	145±10%	83.0
10	24	15.6	1.2	31.2	580±10%	41.0
11	48	31.2	2.4	62.4	2200±10%	22.0
13	110	71.5	5.5	143.0	13000±10%	9.0

Coil versions, AC coil

Coil code	Nominal voltage Vac	Pull-in voltage Vac	Release voltage Vac	Maximum voltage Vac	Coil resistance Ω	Coil current mA
23	24	18	3.6	27.0	145±10%	75.0
25	60	45	9.0	69.0	950±10%	30.0
26	110	83	16.0	127.0	3100±10%	16.0
27	230	175	35.0	253.0	11400±10%	9.0

All figures are given for coil without preenergization, at ambient temperature +20°C
Other coil voltages on request

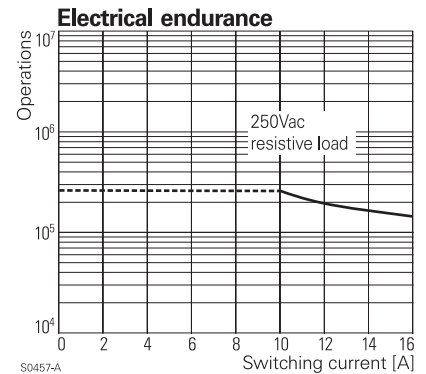
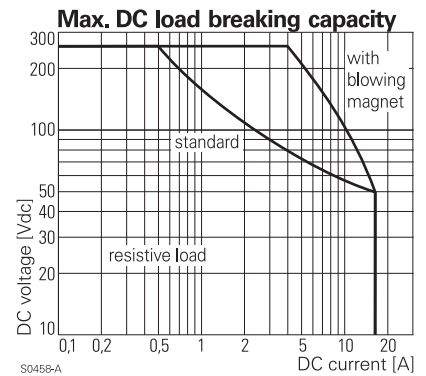

Power Relay 430 3 mm

1 pole 16 A, DC- and AC-coil

Insulation		
Dielectric strength	coil-contacts	4000 V _{rms}
	open contact circuit	2000 V _{rms}
Clearance / creepage		8 / 8 mm
Insulation to IEC 60664		
Voltage rating		250 V
Pollution degree		3
Overvoltage category		III
Insulation to VDE 0110b (2/79)		
Insulation category / reference voltage		C / 250
Tracking resistance of relay base		PTI 380H

Other data	
Ambient temperature	-20...+70 °C
Mechanical life	>2.5x10 ⁵ operations
Max. switching rate at rated- / minimum load	15 min ⁻¹ / 300 min ⁻¹
Operate- / release time	typ. 15 / 8 ms
Bounce time	typ. 4 ms
Shock resistance (destruction)	100 g
Category of protection (IEC 61810)	RT I - dust protected
Relay weight	32 g
Packaging unit	50 pcs.

PCB layout / terminal assignment

View on solder pins
Dimensions in mm

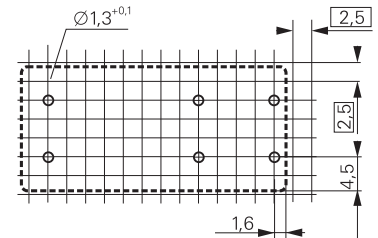

S0448-AE

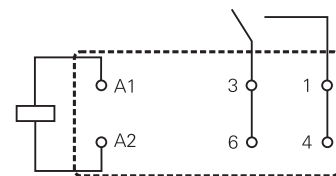

S0448-AF

Dimensions Snap mounting

Dimensions in mm

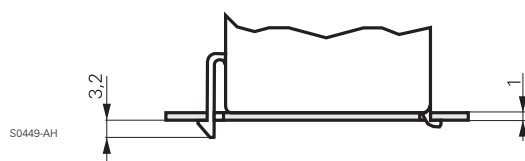
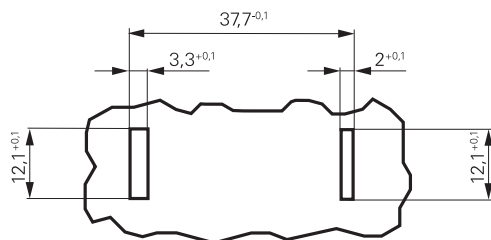
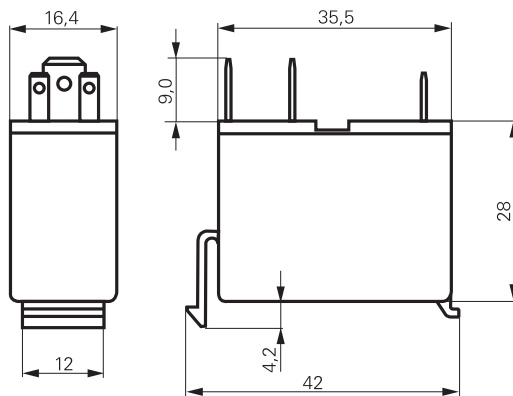

S0449-AH

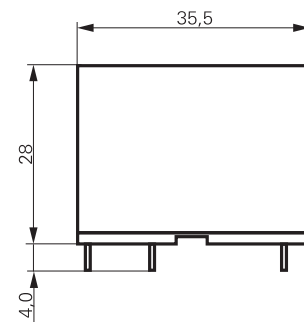

S0449-AB

Power Relay 430 3 mm

1 pole 16 A, DC- and AC-coil

Dimensions

Dimensions in mm

Mounting brackets

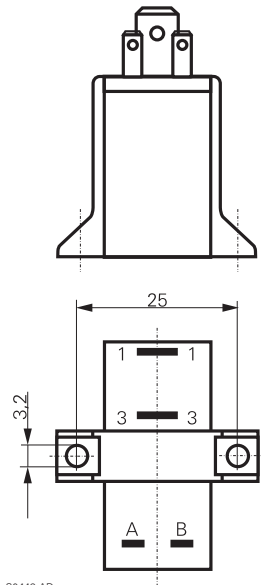

Product key

0 4 3 0 **1 0 0**

Type

Mounting

- 0** PCB version
- 1** mounting brackets
- 2** snap mounting
- 5** DIN rail mounting

Contact design

- 4** arc blowing magnet
- 5** standard

Coil

Coil code: Please refer to coil versions table

Contact material

- 0** AgCu3
- 1** AgCdO

Other types on request

Product key	Version	Cont-material	Cont-config.	Coil	Coil	Part number
0430 25 0911 00	snap mounting	AgCdO	1 N/O contact	DC-coil	12Vdc	1-1415404-1
0430 25 1011 00	1.0mm plate				24Vdc	1-1415404-3
0430 25 2811 00				AC-coil	240Vac	1-1415404-6

Power Relay 430

1 pole 16 A or 2 pole 10 A, DC- and AC-coil



F0257-A

Features

- 1 or 2 pole in N/O, C/O and N/C versions
- 4 kV / 8 mm coil-contact
- PCB mounting or Faston connectors
- Mounting brackets or snap mounting

Applications

Motors, electro valves



Technical data of approved types on request

Contact data	430 x6	430 x7
Configuration	1 N/O, C/O, N/C	2 N/O, C/O, N/C
Type of contact	single contact	
Rated current	16 A	10 A
Rated voltage / max.breaking voltage AC	250 Vac / 400 Vac	
Maximum breaking capacity AC	4000 VA	2500 VA
Make current (max. 4 s at duty cycle 10%)	25 A	15 A
Contact material	AgCdO, AgCu3	

Contact ratings

Type	Load	Operations
1 pole	16 A, 250 Vac, resistive	2.5×10^5
2 pole	10 A, 250 Vac, resistive	2.5×10^5

Coil data

Nominal voltage	DC coil	6...110 Vdc
	AC coil	6...240 Vac
Nominal coil power	DC coil	1 W
	AC coil	1.8 VA
Operate category	2 / b	

Coil versions, DC coil

Coil code	Nominal voltage Vdc	Pull-in voltage Vdc	Release voltage Vdc	Maximum voltage Vdc	Coil resistance Ω	Coil current mA
09	12	7.8	0.6	15.6	$145 \pm 10\%$	83.0
10	24	15.6	1.2	31.2	$580 \pm 10\%$	41.0
11	48	31.2	2.4	62.4	$2200 \pm 10\%$	22.0
13	110	71.5	5.5	143.0	$13000 \pm 10\%$	9.0

Coil versions, AC coil

Coil code	Nominal voltage Vac	Pull-in voltage Vac	Release voltage Vac	Maximum voltage Vac	Coil resistance Ω	Coil current mA
03	24	18.0	3.6	27.0	$200 \pm 10\%$	75.0
05	60	45.0	9.0	69.0	$1250 \pm 10\%$	30.0
06	110	83.0	16.0	127.0	$4500 \pm 10\%$	16.0
07	230	170.0	35.0	253.0	$17500 \pm 10\%$	10.0

All figures are given for coil without preenergization, at ambient temperature +20°C

Other coil voltages on request

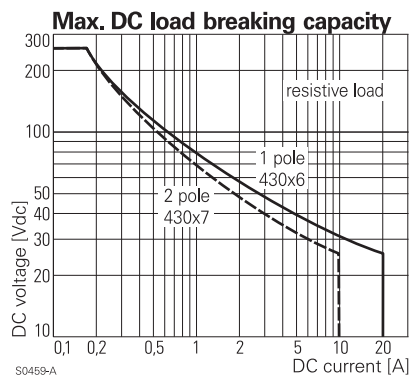

S0459-A

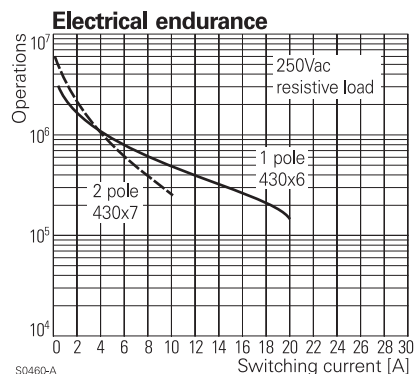

S0460-A

Power Relay 430

1 pole 16 A or 2 pole 10 A, DC- and AC-coil

Insulation

Dielectric strength	coil-contacts	4000 V _{rms}
	open contact circuit	1000 V _{rms}
Clearance / creepage		8 / 8 mm
Insulation to IEC 60664		
Voltage rating		250 V
Pollution degree		3
Overvoltage category		III
Insulation to VDE 0110b (2/79)		
Insulation category / reference voltage		C / 250
Tracking resistance of relay base		PTI 380M

Other data

Ambient temperature	-20...+70 °C
Mechanical life	>2.5x10 ⁵ operations
Max. switching rate at rated- / minimum load	15 min ⁻¹ / 600 min ⁻¹
Operate- / release time	typ. 18 / 3 ms
Bounce time	typ. 3 ms
Shock resistance (destruction)	100 g
Category of protection (IEC 61810)	RT I - dust protected
Relay weight	32 g
Packaging unit	50 pcs.

PCB layout / terminal assignment

View on solder pins
Dimensions in mm

PCB version, 1 C/O contact

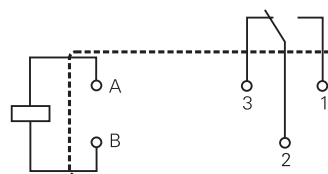
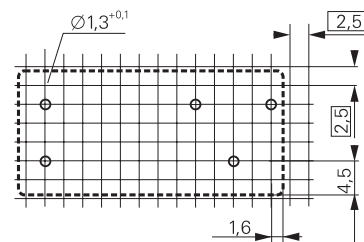

S0448-AA

S0448-AA

Dimensions

Dimensions in mm

Snap mounting

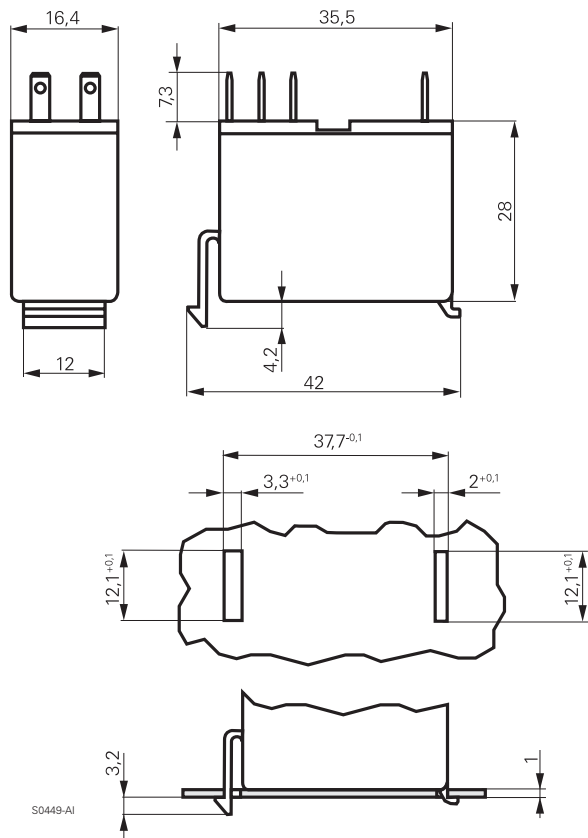

PCB version, 2 C/O contacts

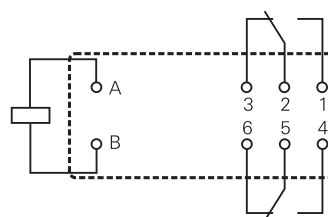
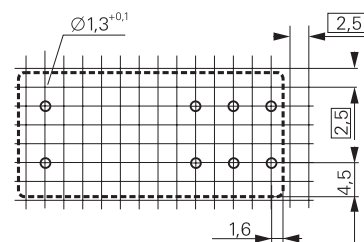

S0448-AC

S0448-AD

Dimensions

Dimensions in mm

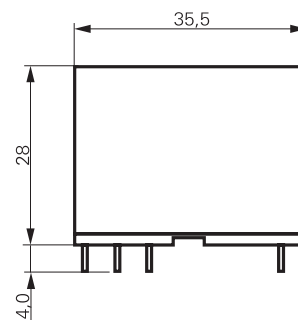

S0449-AA

Power Relay 430

1 pole 16 A or 2 pole 10 A, DC- and AC-coil

Dimensions

Dimensions in mm

Mounting brackets

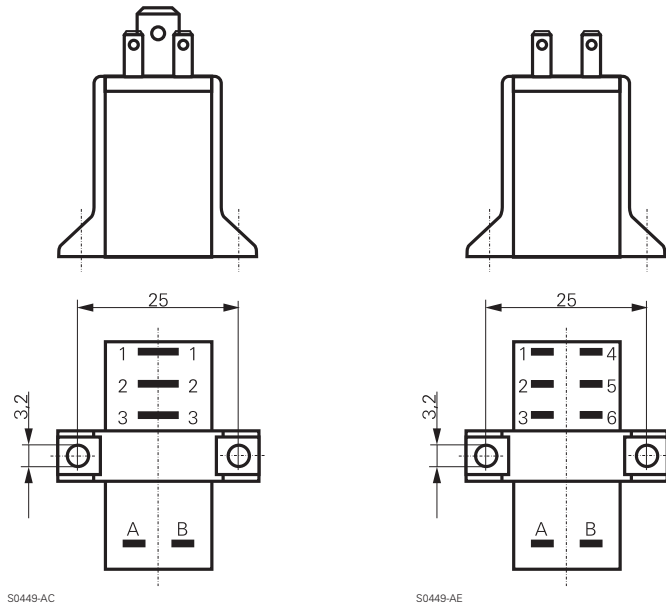

Product key

0 4 3 0 [] [] [] [] [] 0 0

Type

Mounting

- 0 PCB version
- 1 mounting brackets
- 2 snap mounting
- 5 DIN rail mounting

Version

- 6 1 pole
- 7 2 pole

Coil

Coil code: Please refer to coil versions table

Contact material

- 0 AgCu3
- 1 AgCdO

Contact configuration

- 1 1 N/O contact
- 2 1 N/C contact
- 3 1 C/O contact
- 4 2 N/O contacts
- 5 2 N/C contacts
- 6 2 C/O contacts

Other types on request

Product key	Version	Cont-material	Cont.configuration	Coil	Coil	Part number
0430 16 0911 00	snap mounting	AgCdO	1 N/O contact	DC-coil	12Vdc	8-1415430-1
0430 16 1011 00	1.0mm plate				24Vdc	8-1415430-3
0430 16 1013 00			1 C/O contact			8-1415430-5
0430 17 0916 00			2 C/O contacts		12Vdc	0-1415404-1
0430 17 1016 00					24Vdc	0-1415404-4
0430 26 0713 00			1 C/O contact	AC-coil	220Vac	2-1415404-3
0430 27 0716 00			2 C/O contacts		220Vac	2-1415404-8

Rast 5 Power Relay 419 01

2 pole 16 A, DC- and AC-coil



F0255-A

Features

- Safety mains insulation
- Contact gap > 3 mm
- 4 kV / 8 mm coil-contact
- Ambient temperature up to 90°C
- Faston connectors (DIN 46244)
- Snap or screw mounting

Applications

Industrial and domestic appliances, absolute safe power supply disconnection



Technical data of approved types on request

Contact data

Configuration	2 N/O contact
Type of contact	single contact
Rated current	16 A
Rated voltage / max.breaking voltage AC	250 Vac / 400 Vac
Maximum breaking capacity AC	4000 VA
Make current (max. 4 s at duty cycle 10%)	25 A
Contact material	AgCdO, AgNi
Contact gap	>3 mm

Contact ratings

Type	Load	Operations
DC-version	16 A, 250 Vac, resistive	2.5x10 ⁵
DC-version	12 A, 250 Vac, resistive	2.5x10 ⁵
AC-version	16 A, 250 Vac, resistive	1x10 ⁵
AC-version	12 A, 250 Vac, resistive	1x10 ⁵

Coil data

Nominal voltage	DC coil	6...24 Vdc
	AC coil	120...400 Vac
Nominal coil power	DC coil	1.3 W
	AC coil	2.0...2.5 VA
Operate category	2 / c	

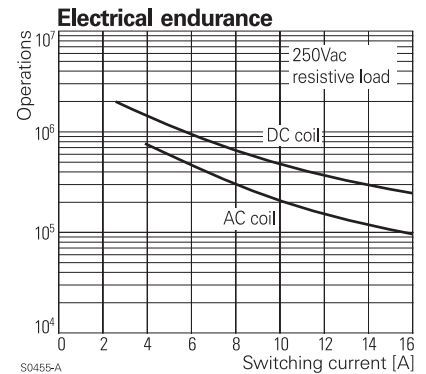

S0455-A

Coil versions, DC coil

Coil code	Nominal voltage Vdc	Pull-in voltage Vdc	Release voltage Vdc	Maximum voltage Vdc	Coil resistance Ω	Coil current mA
31	12	7.7	0.9	19.5	118±10%	102.0
29	24	15.5	1.8	39.0	470±10%	51.0

Coil versions, AC coil

Coil code	Nominal voltage Vac, 50 Hz	Pull-in voltage Vac	Release voltage Vac	Maximum voltage Vac	Coil resistance Ω	Coil current mA
14	110...120	93.0	18.0	132.0	1650±10%	20.0
10	220...240	187.0	36.0	264.0	6600±10%	10.0
09	380...400	323.0	60.0	440.0	20000±10%	6.0

All figures are given for coil without preenergization, at ambient temperature +20°C
Other coil voltages on request

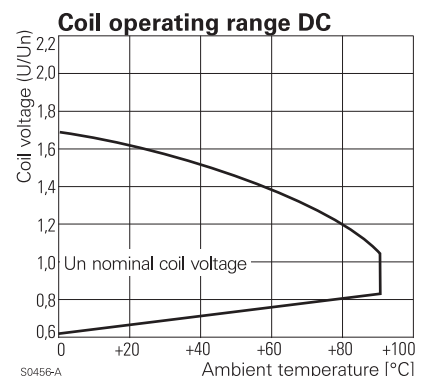

S0456-A

Rast 5 Power Relay 419 01

2 pole 16 A, DC- and AC-coil

Insulation		
Dielectric strength	coil-contacts	4000 V _{rms}
	open contact circuit	2000 V _{rms}
Clearance / creepage		8 / 8 mm
Insulation to IEC 60664		
Voltage rating		250 V
Pollution degree		3
Overvoltage category		III
Insulation to VDE 0110b (2/79)		
Insulation category / reference voltage		C / 380
Tracking resistance of relay base		CTI 600M

Other data	
Ambient temperature	-20...+90 °C
Mechanical life	>2x10 ⁶ operations
Max. switching rate at rated- / minimum load	15 min ⁻¹ / 600 min ⁻¹
Operate- / release time	typ. 15 / 15 ms
Bounce time	typ. 4 ms
Vibration resistance	2 g, 5...500 Hz
Shock resistance (destruction)	80 g
Category of protection (IEC 61810)	RT I - dust protected
Relay weight	90 g
Packaging unit	42 pcs.

Snap mounting / dimensions

Dimensions in mm

Terminal assignment

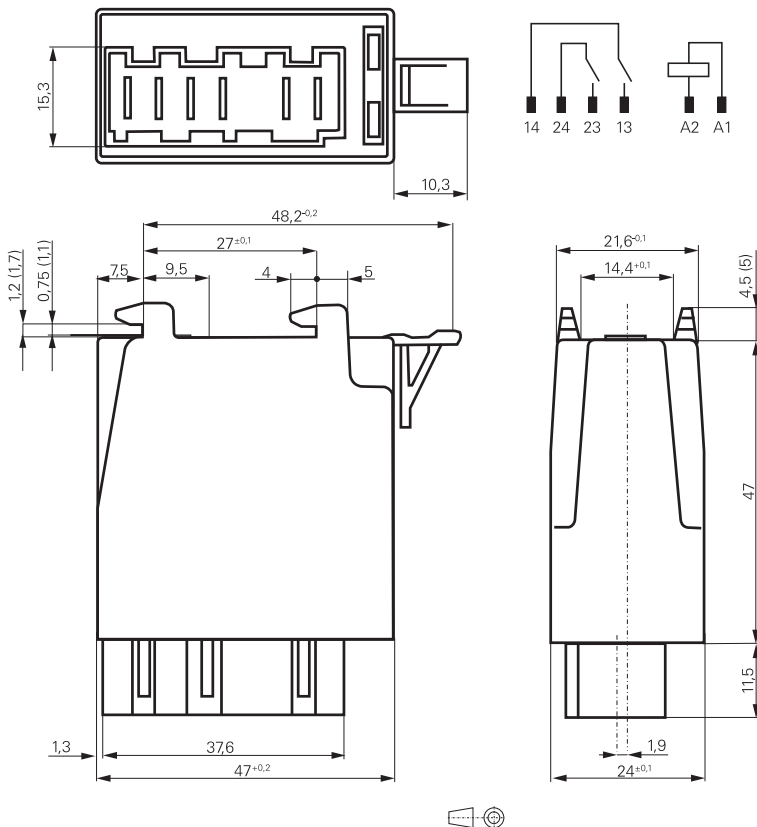

Rast 5 Power Relay 419 01

2 pole 16 A, DC- and AC-coil

Screw mounting / dimensions

Dimensions in mm

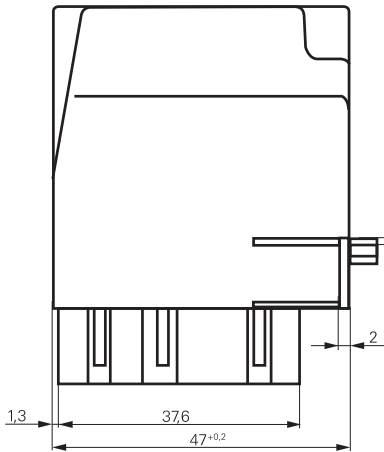
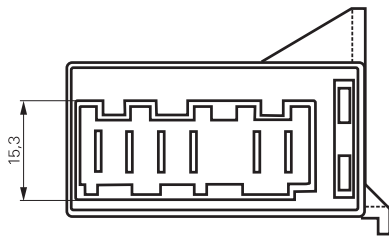

Terminal assignment

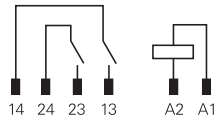

S0447-AB

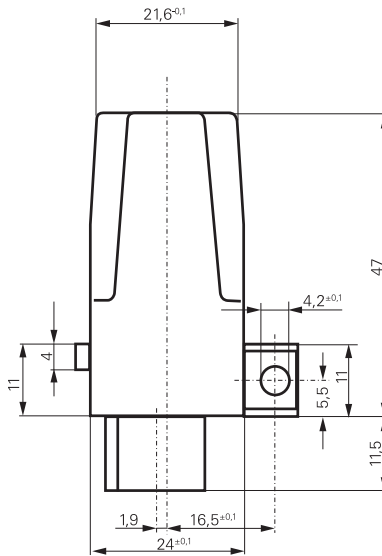

Product key

0 4 1 9 **0 1**

Type

Coil

Coil code: Please refer to coil versions table

Contact material

01 AgCdO

03 AgNi 90/10

Mounting

00 Snap mounting, 1.0 mm panel

01 Snap mounting, 1.5 mm panel

02 Screw mounting

Other types on request

Product key	Version	Cont-material	Cont.configuration	Coil	Part number
0419 01 2901 00	snap mounting 1.0mm	AgCdO	2 N/O contacts	24Vdc	2-1415419-6
0419 01 2901 01	snap mounting 1.5mm				2-1415419-7
0419 01 2901 02	screw mounting				2-1415419-8
0419 01 1001 00	snap mounting 1.0mm			220-240Vac	0-1415419-7
0419 01 1001 01	snap mounting 1.5mm				0-1415419-8
0419 01 1001 02	screw mounting				0-1415419-9

Safety Relay SR2M

2 pole 6 A



Features

- Forcibly guided contacts according to EN 50205
- 2 pole safety relay with either 1N/O+1N/C or 2C/O contacts
- 6 kV surge resistance between poles

Applications

Emergency shut-off, machine control, elevator and escalator control, light barrier control

F0188-C



Technical data of approved types on request

Contact data

Configuration	1 N/C contact and 1 N/O contact or 2 C/O contact *)
Type of contact	single contact, forcibly guided
Rated current	6 A
Rated voltage / max. breaking voltage AC	250 Vac / 440 Vac
Maximum breaking capacity AC	1500 VA
Contact material	AgNi
Minimum contact load	> 50 mW
Contact resistance	≤ 100 mΩ / 1 A / 24 Vdc ≤ 2 Ω / 10 mA / 5 Vdc

*) According EN50205 only 1N/O / 1N/C (11-14 and 22-21 or 12-11 and 21-24) shall be used as forcibly guided contacts.

Coil data

Nominal voltage	5...110 Vdc
Nominal coil power	approx. 700 mW
Operative range	2

Coil versions

Coil code	Nominal voltage Vdc	Pull-in voltage Vdc	Release voltage Vdc	Coil resistance Ω	Coil current mA
005	5	3.8	0.5	35.7±10%	140.0
006	6	4.5	0.6	51±10%	117.6
009	9	6.75	0.9	116±10%	77.6
012	12	9.0	1.2	206±10%	58.3
018	18	13.5	1.8	483±10%	37.3
021	21	15.8	2.1	630±10%	33.3
024	24	18.0	2.4	823±10%	29.2
036	36	27.0	3.6	1851±10%	19.4
040	40	30.0	4.0	2286±10%	17.5
048	48	36.0	4.8	3291±12%	14.6
060	60	45.0	6.0	5142±12%	11.7
080	80	60.0	8.0	9143±12%	8.7
110	110	82.5	11.0	17285±12%	6.4

All figures are given for coil without preenergization, at ambient temperature +20°C

$U_{op\ max}$: at 70 °C after preenergization with $1.1 \times U_{nom}$ the max. operate voltage is 85% of U_{nom} . U_{max} : at 70 °C the max. coil voltage is $1.1 \times U_{nom}$

Other coil voltages on request

Max. DC load breaking capacity

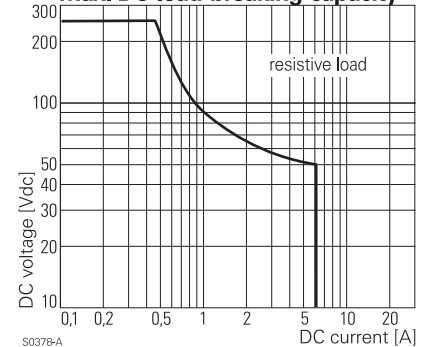

S0378-A

Electrical endurance

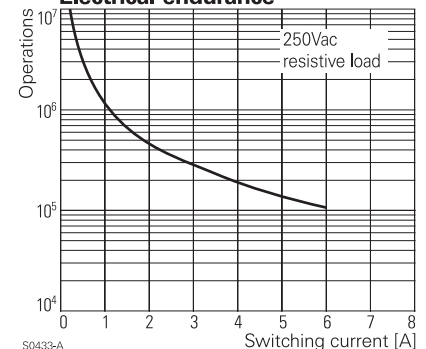

S0433-A

Coil operating range DC

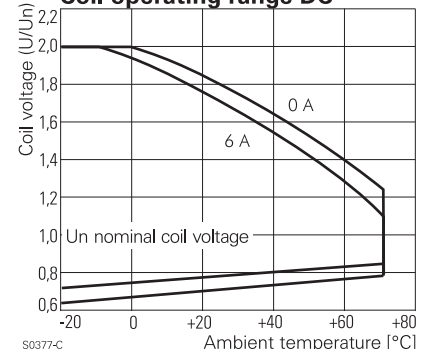

S0377-C

Safety Relay SR2M

2 pole 6 A

Insulation

Dielectric strength	coil-contacts	4000 V _{rms}
	open contact circuit	1000 V _{rms}
	adjacent contacts	3000 V _{rms}
Clearance / creepage	coil-contacts	8 / 8 mm
	adjacent contacts	5.5 / 5.5 mm
Insulation to IEC 60664		
	Voltage rating	250 V
	Pollution degree	2
	Overvoltage category	III
Insulation resistance (500 Vdc)		> 1x10 ⁶ Ω
Tracking resistance of relay base		CTI 250

Other data

Ambient temperature	-25...+70 °C
Mechanical life	10x10 ⁶ operations
Max. switching rate at rated- / minimum load	6 min ⁻¹ / 300 min ⁻¹
Operate- / release time	typ. 10 / 4 ms
Vibration resistance N/O / N/C contact	> 10 / 2.5 g, 15...200 Hz
Shock resistance (function)N/O contact / N/C contact	> 10 / 5 g, 11 ms half sine
Category of protection (IEC 61810)	RT III - wash tight
Relay weight	20 g
Packaging unit	20 pcs.
Accessories	see accessories SR2M

Dimensions

Dimensions in mm

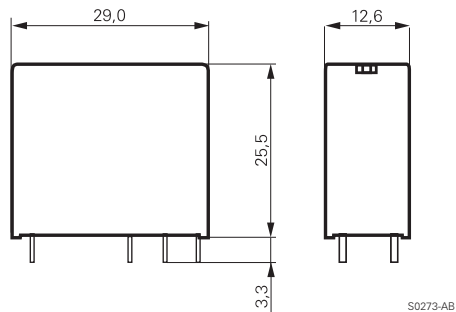

S0273-AB

PCB layout / terminal assignment

View on solder pins
Dimensions in mm

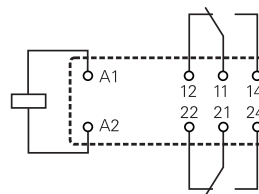
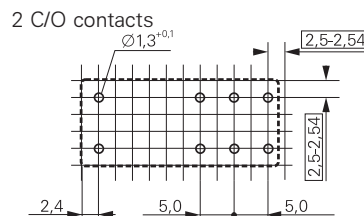

S0163-CO

S0163-CJ

1 N/O and 1 N/C contacts

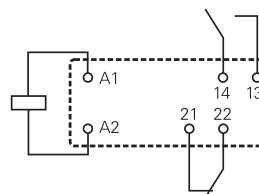
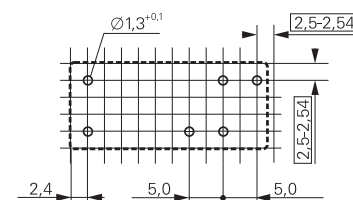

S0163-CU

S0163-CV

Product key

V 2 3 0 4 7 - A 1 - A 5

Type

Version

A1 standard

Coil

Coil code = nominal voltage (e.g. 024=24Vdc)

Contact type

A single contact

Contact material

5 AgNi

Contact configuration

01 2 C/O contacts

11 1 N/O and 1 N/C contact

Other types on request

Safety Relay SR2M

2 pole 6 A

Product key	Version	Contact material	Configuration	Coil	Part number
V23047-A1005-A501	standard	AgNi	2 C/O contacts	5 Vdc	0-1393258-2
V23047-A1005-A511	wash tight		1 N/O + 1 N/C	5 Vdc	7-1415006-1
V23047-A1006-A501			2 C/O contacts	6 Vdc	3-1415011-1
V23047-A1006-A511			1 N/O + 1 N/C	6 Vdc	6-1415011-1
V23047-A1009-A501			2 C/O contacts	9 Vdc	0-1393258-3
V23047-A1009-A511			1 N/O + 1 N/C	9 Vdc	7-1415011-1
V23047-A1012-A501			2 C/O contacts	12 Vdc	0-1393258-4
V23047-A1012-A511			1 N/O + 1 N/C	12 Vdc	0-1393258-5
V23047-A1018-A501			2 C/O contacts	18 Vdc	0-1393258-8
V23047-A1018-A511			1 N/O + 1 N/C	18 Vdc	0-1393258-9
V23047-A1021-A501			2 C/O contacts	21 Vdc	1-1393258-1
V23047-A1021-A511			1 N/O + 1 N/C	21 Vdc	1-1393258-2
V23047-A1024-A501			2 C/O contacts	24 Vdc	1-1393258-5
V23047-A1024-A511			1 N/O + 1 N/C	24 Vdc	1-1393258-7
V23047-A1036-A501			2 C/O contacts	36 Vdc	2-1393258-0
V23047-A1036-A511			1 N/O + 1 N/C	36 Vdc	8-1415011-1
V23047-A1040-A501			2 C/O contacts	40 Vdc	2-1393258-1
V23047-A1040-A511			1 N/O + 1 N/C	40 Vdc	2-1393258-2
V23047-A1048-A501			2 C/O contacts	48 Vdc	3-1415006-1
V23047-A1048-A511			1 N/O + 1 N/C	48 Vdc	9-1415011-1
V23047-A1060-A511				60 Vdc	2-1393258-3

Safety Relay SR4 D/M

4 pole 8 A



Features

- Forcibly guided contacts according to EN 50205
- 4 pole safety relay with either
2 N/O+2 N/C or 3 N/O+1 N/C contacts
- Very small outlines

Available August 2002

Applications

Emergency shut-off, machine control, elevator and escalator control, light barrier control

F0244-A



Technical data of approved types on request

in preparation

Contact data

Configuration	3 N/O contact and 1 N/C contact or 2 N/O contact and 2 N/C contact
Type of contact	single contact, forcibly guided
Continuous thermal load	8 A
Rated voltage / max. breaking voltage AC	250 Vac / 440 Vac
Maximum breaking capacity AC	2000 VA
Contact material	AgSnO ₂
Minimum contact load	> 50 mW
Contact resistance	≤100 mΩ / 1 A / 24 Vdc ≤20 Ω / 10 mA / 5 Vdc

Coil data

Nominal voltage	5...110 Vdc
Nominal coil power	800 mW
Operative range	2
Max. coil voltage	150 % U _{nom}

Coil versions

Coil code	Nominal voltage Vdc	Pull-in voltage Vdc	Release voltage Vdc	Maximum voltage Vdc	Coil resistance Ω	Coil current mA
005	5	3.8	0.5	7.5	31±10%	161.3
006	6	4.5	0.6	9.0	45±10%	133.3
009	9	6.8	0.9	13.5	101±10%	89.1
012	12	9.0	1.2	18.0	180±10%	66.7
015	15	11.3	1.5	22.5	281±10%	53.4
018	18	13.5	1.8	27.0	405±10%	44.4
021	21	15.8	2.1	31.5	551±10%	38.1
024	24	18.0	2.4	36.0	720±10%	33.3
036	36	27.0	3.6	54.0	1620±10%	22.2
040	40	30.0	4.0	60.0	2000±10%	20.0
048	48	36.0	4.8	72.0	2880±10%	16.7
060	60	45.0	6.0	90.0	4500±10%	13.3
085	85	63.8	8.5	127.5	9031±10%	9.4
110	110	82.5	11.0	165.0	15125±10%	7.3

All figures are given for coil without preenergization, at ambient temperature +20°C

U_{op max}: at 70 °C after preenergization with 1.1 x U_{nom} the max. operate voltage is 85% of U_{nom}. U_{max}: at 70 °C the max. coil voltage is 1.1 x U_{nom}

Other coil voltages on request

Safety Relay SR4 D/M

4 pole 8 A

Insulation		
Dielectric strength	coil-contacts	4000 V _{rms}
	open contact circuit	1000 V _{rms}
	adjacent contacts	2500 V _{rms}
Clearance / creepage coil-contact	adjacent contacts	10 / 10 mm
	adjacent contacts	3 / 3.5 mm
Insulation to IEC 60664		
	Voltage rating	250 V
	Pollution degree	2
	Overvoltage category	III
Insulation resistance (500 Vdc)		> 1x10 ⁶ Ω
Tracking resistance of relay base		CTI 250

Other data	
Ambient temperature	-25...+70 °C
Mechanical life	≥ 10x10 ⁶ operations
Max. switching rate at rated- / minimum load	6 min ⁻¹ / 300 min ⁻¹
Operate- / release time	typ. 12 / 20 ms
Vibration resistance N/O / N/C contact	> 8 / 2.5 g, 10...200 Hz
Category of protection (IEC 61810)	RT III - wash tight
Relay weight	16 g
Packaging unit	10 pcs.

PCB layout / terminal assignment

View on solder pins
Dimensions in mm

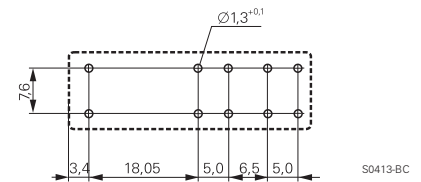

2 N/O and 2 N/C contacts

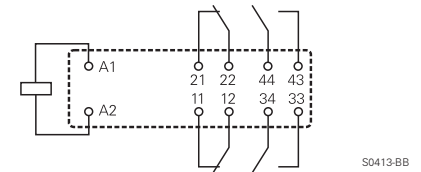

3 N/O and 1 N/C contacts

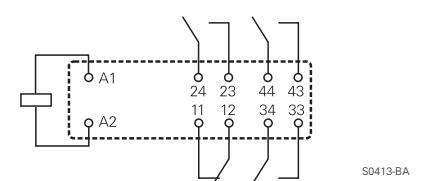

Dimensions

Dimensions in mm

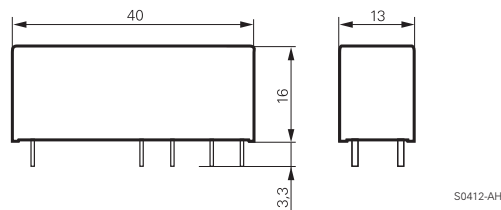

Product key

Type

Contact configuration

D 2 N/O + 2 N/C contacts

M 3 N/O + 1 N/C contacts

Contact material

4 AgSnO₂

Coil

Coil code = nominal voltage (e.g. 024=24Vdc)

Other types on request

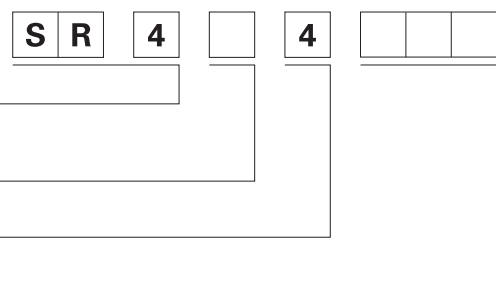

Safety Relay SR4 D/M

4 pole 8 A

Product key	Type	Contact configuration	Contact material	Coil	Part number			
SR4D4005	4 pole safety relay	2 N/O + 2 N/C contacts	AgSnO	5 Vdc	7-1415054-1			
SR4D4006				6 Vdc	8-1415054-1			
SR4D4009				9 Vdc	9-1415054-1			
SR4D4012				12 Vdc	0-1415055-1			
SR4D4018				18 Vdc	1-1415055-1			
SR4D4021				21 Vdc	2-1415055-1			
SR4D4024				24 Vdc	3-1415055-1			
SR4D4036				36 Vdc	4-1415055-1			
SR4D4040				40 Vdc	5-1415055-1			
SR4D4048				48 Vdc	6-1415055-1			
SR4D4060				60 Vdc	7-1415055-1			
SR4D4085				85 Vdc	8-1415055-1			
SR4D4110				110 Vdc	9-1415055-1			
SR4M4005				3 N/O + 1 N/C contacts	3 N/O + 1 N/C contacts	AgSnO	5 Vdc	5-1415053-1
SR4M4006							6 Vdc	6-1415053-1
SR4M4009	9 Vdc	7-1415053-1						
SR4M4012	12 Vdc	8-1415053-1						
SR4M4018	18 Vdc	9-1415053-1						
SR4M4021	21 Vdc	0-1415054-1						
SR4M4024	24 Vdc	4-1415053-1						
SR4M4036	36 Vdc	1-1415054-1						
SR4M4040	40 Vdc	2-1415054-1						
SR4M4048	48 Vdc	3-1415054-1						
SR4M4060	60 Vdc	4-1415054-1						
SR4M4085	85 Vdc	5-1415054-1						
SR4M4110	110 Vdc	6-1415054-1						

Safety Relay SR6 D/M

4 pole 8 A



Features

- Forcibly guided contacts according to EN 50205
- 4 pole safety relay with either
2 N/O+2 N/C or 3 N/O+1 N/C
- High insulation distances for safe separation of electrical circuits

Applications

Emergency shut-off, press control, machine control, elevator and escalator control, safety modules



Technical data of approved types on request

Contact data

Configuration	3 N/O contact and 1 N/C contact or 2 N/O contact and 2 N/C contact
Type of contact	single contact, forcibly guided
Continuous thermal load	8 A
Rated voltage / max. breaking voltage AC	250 Vac / 440 Vac
Maximum breaking capacity AC	2000 VA
Contact material	AgSnO ₂
Minimum contact load	> 50 mW
Contact resistance	≤100 mΩ / 1 A / 24 Vdc ≤20 Ω / 10 mA / 5 Vdc

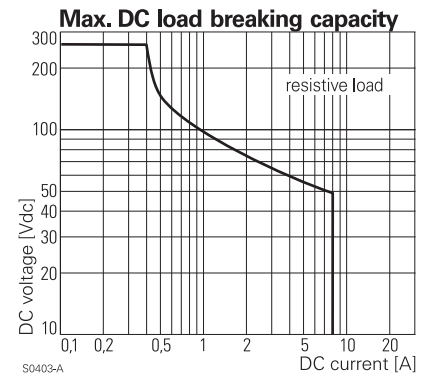

Coil data

Nominal voltage	5...110 Vdc
Nominal coil power	1200 mW
Operative range	2
Max. coil voltage	150 % U _{nom}

Coil versions

Coil code	Nominal voltage Vdc	Pull-in voltage Vdc	Release voltage Vdc	Maximum voltage Vdc	Coil resistance Ω	Coil current mA
005	5	3.8	0.5	7.5	21±10%	238.1
006	6	4.5	0.6	9.0	30±10%	200.0
009	9	6.8	0.9	13.5	68±10%	132.4
012	12	9.0	1.2	18.0	120±10%	100.0
018	18	13.5	1.8	22.5	270±10%	66.7
021	21	15.8	2.1	27.0	368±10%	57.1
024	24	18.0	2.4	36.0	480±10%	50.0
036	36	27.0	3.6	54.0	1080±10%	33.3
040	40	30.0	4.0	60.0	1333±10%	30.0
048	48	36.0	4.8	72.0	1920±10%	25.0
060	60	45.0	6.0	90.0	3000±12%	20.0
085	85	64.0	8.5	127.5	6021±12%	14.1
110	110	82.5	11.0	165.0	10080±12%	10.9

All figures are given for coil without preenergization, at ambient temperature +20°C

U_{op max}: at 70 °C after preenergization with 1.1 x U_{nom} the max. operate voltage is 85% of U_{nom}. U_{max}: at 70 °C the max. coil voltage is 1.1 x U_{nom}

Other coil voltages on request

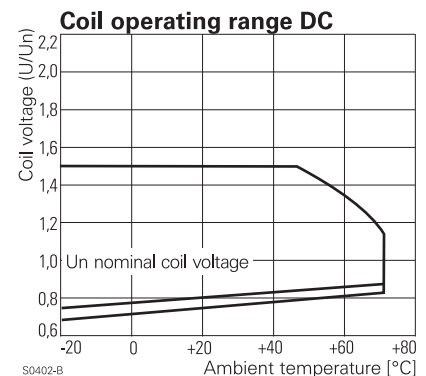

Safety Relay SR6 D/M

4 pole 8 A

Insulation

Dielectric strength	coil-contacts	3000 V _{rms}
	open contact circuit	1000 V _{rms}
	adjacent contacts	3000 V _{rms} / 4000 V _{rms} *)
Clearance / creepage	coil-contact	5.5 / 5.5 mm
	adjacent contacts	5.5 / 5.5 mm or 12 / 12 mm *)
Insulation to IEC 60664		
	Voltage rating	250 V
	Pollution degree	2
	Overvoltage category	III
Insulation resistance (500 Vdc)		> 1x10 ⁶ Ω
Tracking resistance of relay base		CTI 250
*) in longitudinal direction		

Other data

Ambient temperature	-25...+70 °C
Mechanical life	≥ 10x10 ⁶ operations
Max. switching rate at rated- / minimum load	6 min ⁻¹ / 300 min ⁻¹
Operate- / release time	typ. 11 / 3 ms
Vibration resistance N/O / N/C contact	> 8 / 5 g, 10...200 Hz
Shock resistance (function) N/O contact / N/C contact	> 8 / 6 g, 16ms half sine
Category of protection (IEC 61810)	RT III - wash tight
Relay weight	30 g
Packaging unit	10 pcs.

Dimensions

Dimensions in mm

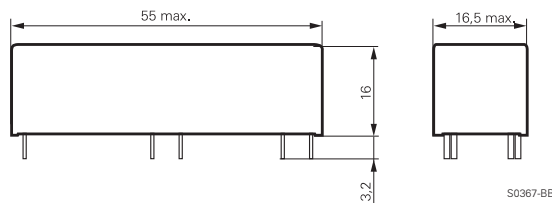

PCB layout / terminal assignment

View on solder pins
Dimensions in mm

2 N/O+2 N/C versions

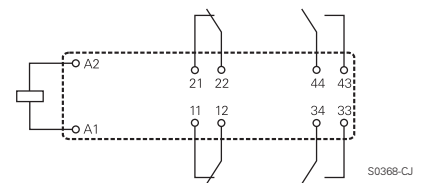
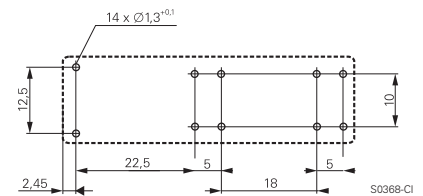

3 N/O + 1 N/C version

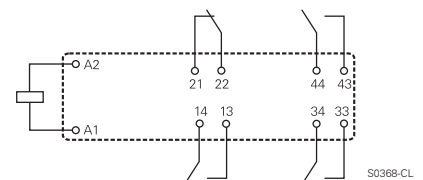
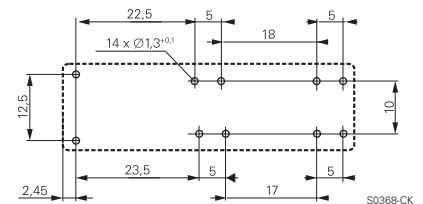

Product key

Type

Contact configuration

D 2 N/O + 2 N/C contacts

M 3 N/O + 1 N/C contacts

Contact material

4 AgSnO₂

Coil

Coil code = nominal voltage (e.g. 024=24Vdc)

Other types on request

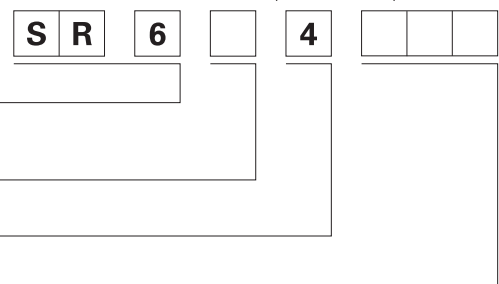

Product key	Type	Contact configuration	Contact material	Coil	Part number
SR6D4024	4-pole	2 N/O + 2 N/C	AgSnO	24 Vdc	6-1415027-1
SR6D4110	safety relay	contacts		110 Vdc	0-1415062-1

Safety Relay SR6

6 pole 8 A



Features

- Forcibly guided contacts according to EN50205
- Small 6 pole safety relay with either
4 N/O+2 N/C or 3 N/O+3 N/C or 5 N/O+1 N/C contacts
- 6 kV surge resistance between poles

Applications

Emergency shut-off, press control, machine control, elevator and escalator control, safety modules

F0206-B



Technical data of approved types on request

Contact data

Configuration	3 N/O contact and 3 N/C contact or 4 N/O contact and 2 N/C contact or 5 N/O contact and 1 N/C contact
Type of contact	single contact, forcibly guided
Continuous thermal load	8 A
Rated voltage / max.breaking voltage AC	250 Vac / 440 Vac
Maximum breaking capacity AC	2000 VA
Minimum contact load	> 50 mW
Contact resistance	≤100 mΩ / 1 A / 24 Vdc ≤20 Ω / 10 mA / 5 Vdc

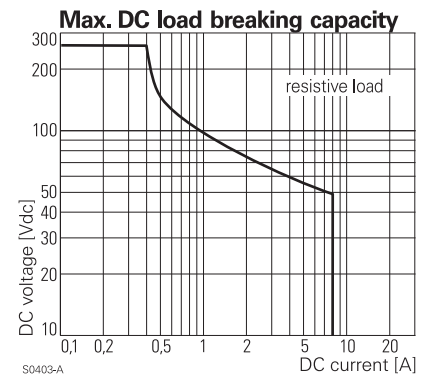

Coil data

Nominal voltage	5...110 Vdc
Nominal coil power	1200 mW
Operative range	2
Max. coil voltage	150 % U _{nom}

Coil versions

Coil code	Nominal voltage Vdc	Pull-in voltage Vdc	Release voltage Vdc	Maximum voltage Vdc	Coil resistance Ω	Coil current mA
005	5	3.8	0.5	7.5	21±10%	238.1
006	6	4.5	0.6	9.0	30±10%	200.0
009	9	6.8	0.9	13.5	68±10%	132.4
012	12	9.0	1.2	18.0	120±10%	100.0
018	18	13.5	1.8	22.5	270±10%	66.7
021	21	15.8	2.1	27.0	368±10%	57.1
024	24	18.0	2.4	36.0	480±10%	50.0
036	36	27.0	3.6	54.0	1080±10%	33.3
040	40	30.0	4.0	60.0	1333±10%	30.0
048	48	36.0	4.8	72.0	1920±10%	25.0
060	60	45.0	6.0	90.0	3000±12%	20.0
085	85	64.0	8.5	127.5	6021±12%	14.1
110	110	82.5	11.0	165.0	10080±12%	10.9

All figures are given for coil without preenergization, at ambient temperature +20°C
 U_{op max}: at 70 °C after preenergization with 1.1 x U_{nom} the max. operate voltage is 85% of U_{nom}. U_{max}: at 70 °C the max. coil voltage is 1.1 x U_{nom}
 Other coil voltages on request

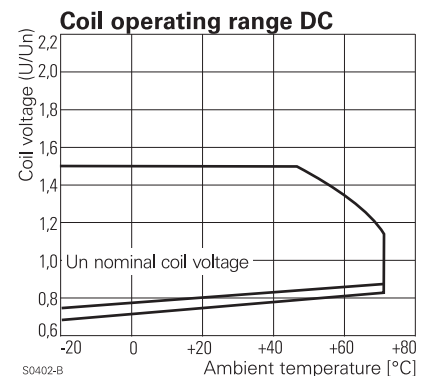

Safety Relay SR6

6 pole 8 A

Insulation

Dielectric strength	coil-contacts	3000 V _{rms}
	open contact circuit	1000 V _{rms}
	adjacent contacts	3000 V _{rms}
Clearance / creepage coil-contact	adjacent contacts	5.5 / 5.5 mm
	adjacent contacts	5.5 / 5.5 mm
Insulation to IEC 60664	Voltage rating	250 V
	Pollution degree	2
	Overvoltage category	III
	Insulation resistance (500 Vdc)	> 1x10 ⁶ Ω
Tracking resistance of relay base		CTI 250

Other data

Ambient temperature	-25...+70 °C
Mechanical life	≥ 10x10 ⁶ operations
Max. switching rate at rated- / minimum load	6 min ⁻¹ / 300 min ⁻¹
Operate- / release time	typ. 11 / 3 ms
Vibration resistance N/O / N/C contact	> 8 / 5 g, 10...200 Hz
Shock resistance (function) N/O contact / N/C contact	> 8 / 6 g, 16ms half sine
Category of protection (IEC 61810)	RT III - wash tight
Relay weight	30 g
Packaging unit	10 pcs.

Dimensions

Dimensions in mm

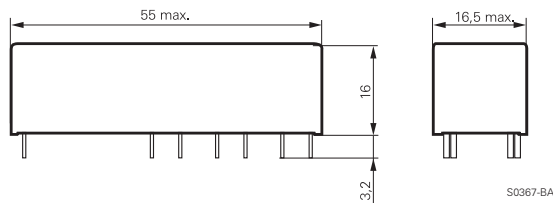

PCB layout / terminal assignment

View on solder pins
Dimensions in mm

4 N/O+2 N/C and 3 N/O+3 N/C versions

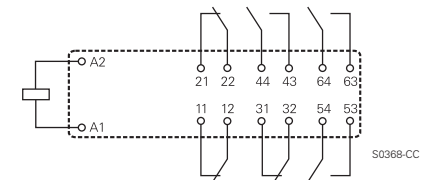
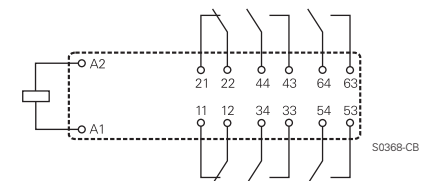
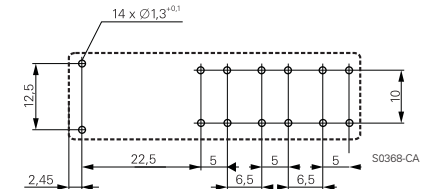

5 N/O + 1 N/C version

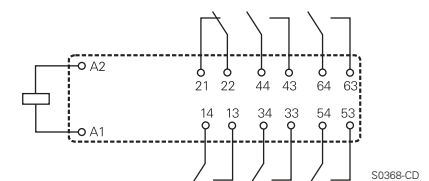
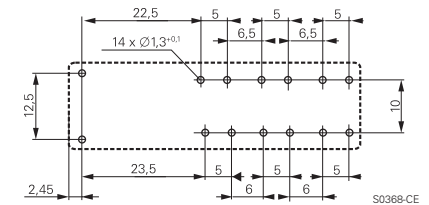

Product key

V 2 3 0 5 0 - A 1 - A 5

Type

Version

A1 standard

Coil

Coil code = nominal voltage (e.g. 024=24Vdc)

Contact type

A single contact

Contact material

5 AgSnO₂

Contact configuration

33 3 N/O and 3 N/C contacts

42 4 N/O and 2 N/C contacts

51 5 N/O and 1 N/C contacts

Other types on request

Safety Relay SR6

6 pole 8 A

Product key	Version	Contact material	Configuration	Coil	Part number
V23050-A1005-A533	standard	AgSnO	3 N/O + 3 N/C	5 Vdc	8-1415017-1
V23050-A1005-A542			4 N/O + 2 N/C	5 Vdc	0-1393260-1
V23050-A1005-A551			5 N/O + 1 N/C	5 Vdc	2-1415017-1
V23050-A1006-A533			3 N/O + 3 N/C	6 Vdc	9-1415017-1
V23050-A1006-A542			4 N/O + 2 N/C	6 Vdc	0-1393260-2
V23050-A1006-A551			5 N/O + 1 N/C	6 Vdc	3-1415017-1
V23050-A1009-A533			3 N/O + 3 N/C	9 Vdc	0-1415018-1
V23050-A1009-A542			4 N/O + 2 N/C	9 Vdc	0-1393260-3
V23050-A1009-A551			5 N/O + 1 N/C	9 Vdc	4-1415017-1
V23050-A1012-A533			3 N/O + 3 N/C	12 Vdc	1-1415015-1
V23050-A1012-A542			4 N/O + 2 N/C	12 Vdc	0-1393260-4
V23050-A1012-A551			5 N/O + 1 N/C	12 Vdc	1-1415017-1
V23050-A1015-A533			3 N/O + 3 N/C	15 Vdc	1-1415018-1
V23050-A1015-A542			4 N/O + 2 N/C	15 Vdc	6-1415014-1
V23050-A1015-A551			5 N/O + 1 N/C	15 Vdc	5-1415017-1
V23050-A1018-A533			3 N/O + 3 N/C	18 Vdc	2-1415018-1
V23050-A1018-A542			4 N/O + 2 N/C	18 Vdc	0-1393260-5
V23050-A1018-A551			5 N/O + 1 N/C	18 Vdc	6-1415017-1
V23050-A1021-A533			3 N/O + 3 N/C	21 Vdc	3-1415018-1
V23050-A1021-A542			4 N/O + 2 N/C	21 Vdc	0-1393260-6
V23050-A1021-A551			5 N/O + 1 N/C	21 Vdc	7-1415017-1
V23050-A1024-A533			3 N/O + 3 N/C	24 Vdc	0-1415015-1
V23050-A1024-A542			4 N/O + 2 N/C	24 Vdc	0-1393260-7
V23050-A1024-A551			5 N/O + 1 N/C	24 Vdc	0-1415017-1
V23050-A1036-A533			3 N/O + 3 N/C	36 Vdc	4-1415018-1
V23050-A1036-A542			4 N/O + 2 N/C	36 Vdc	0-1393260-8
V23050-A1036-A551			5 N/O + 1 N/C	36 Vdc	0-1415019-1
V23050-A1040-A533			3 N/O + 3 N/C	40 Vdc	5-1415018-1
V23050-A1040-A542			4 N/O + 2 N/C	40 Vdc	0-1393260-9
V23050-A1040-A551			5 N/O + 1 N/C	40 Vdc	1-1415019-1
V23050-A1048-A533			3 N/O + 3 N/C	48 Vdc	6-1415018-1
V23050-A1048-A542			4 N/O + 2 N/C	48 Vdc	1-1393260-0
V23050-A1048-A551			5 N/O + 1 N/C	48 Vdc	2-1415019-1
V23050-A1060-A533			3 N/O + 3 N/C	60 Vdc	7-1415018-1
V23050-A1060-A542			4 N/O + 2 N/C	60 Vdc	1-1393260-1
V23050-A1060-A551			5 N/O + 1 N/C	60 Vdc	3-1415019-1
V23050-A1085-A533			3 N/O + 3 N/C	85 Vdc	8-1415018-1
V23050-A1085-A542			4 N/O + 2 N/C	85 Vdc	1-1393260-2
V23050-A1085-A551			5 N/O + 1 N/C	85 Vdc	4-1415019-1
V23050-A1110-A533			3 N/O + 3 N/C	110 Vdc	9-1415018-1
V23050-A1110-A542			4 N/O + 2 N/C	110 Vdc	1-1393260-3
V23050-A1110-A551			5 N/O + 1 N/C	110 Vdc	5-1415019-1

Safety Relay SR6 sensitive

6 pole 8 A



F0206-B

Features

- Forcibly guided contacts according to EN50205
- polarized, monostable with 800 mW coil power consumption
- Smallest 6 pole safety relay with either 4 N/O+2 N/C or 3 N/O+3 N/C or 5 N/O+1 N/C contacts
- 6 kV surge resistance between poles

Applications

Emergency shut-off, press control, machine control, elevator and escalator control, safety modules



planned Technical data of approved types on request

Contact data

Configuration	3 N/O contact and 3 N/C contact or 4 N/O contact and 2 N/C contact or 5 N/O contact and 1 N/C contact
Type of contact	single contact, forcibly guided
Continuous thermal load	8 A
Rated voltage / max.breaking voltage AC	250 Vac / 440 Vac
Maximum breaking capacity AC	2000 VA
Minimum contact load	> 50 mW
Contact resistance	≤100 mΩ / 1 A / 24 Vdc ≤20 Ω / 10 mA / 5 Vdc

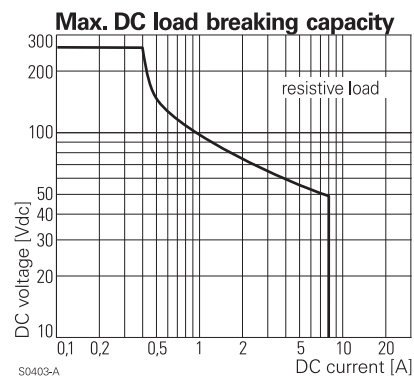

Coil data

Nominal voltage	5...48 Vdc
Nominal coil power	800 mW
Operative range	2
Max. coil voltage	150 % U _{nom}

Coil versions

Coil code	Nominal voltage Vdc	Pull-in voltage Vdc	Release voltage Vdc	Maximum voltage Vdc	Coil resistance Ω	Coil current mA
05	5	3.8	0.5	7.5	31±10%	161.3
06	6	4.5	0.6	9.0	45±10%	133.3
09	9	6.8	0.9	13.5	101±10%	89.1
12	12	9.0	1.2	18.0	180±10%	66.7
15	15	11.3	1.5	22.5	281±10%	53.4
18	18	13.5	1.8	27.0	405±10%	44.4
21	21	15.8	2.1	31.5	551±10%	38.1
24	24	18.0	2.4	36.0	720±10%	33.3
36	36	27.0	3.6	54.0	1620±10%	22.2
40	40	30.0	4.0	60.0	2000±10%	20.0
48	48	36.0	4.8	72.0	2880±10%	16.7

All figures are given for coil without preenergization, at ambient temperature +20°C
 U_{op max}: at 70 °C after preenergization with 1.1 x U_{nom} the max. operate voltage is 85% of U_{nom}. U_{max}: at 70 °C the max. coil voltage is 1.1 x U_{nom}
 Other coil voltages on request

Safety Relay SR6 sensitive

6 pole 8 A

Insulation

Dielectric strength	coil-contacts	3000 V _{rms}
	open contact circuit	1000 V _{rms}
	adjacent contacts	3000 V _{rms}
Clearance / creepage	coil-contact	5.5 / 5.5 mm
	adjacent contacts	5.5 / 5.5 mm
Insulation to IEC 60664		
	Voltage rating	250 V
	Pollution degree	2
	Overvoltage category	III
Insulation resistance (500 Vdc)		> 1x10 ⁶ Ω
Tracking resistance of relay base		CTI 250

Other data

Ambient temperature	-25...+70 °C
Mechanical life	≥ 10x10 ⁶ operations
Max. switching rate at rated- / minimum load	6 min ⁻¹ / 300 min ⁻¹
Operate- / release time	typ. 11 / 3 ms
Vibration resistance N/O / N/C contact	> 8 / 5 g, 10...200 Hz
Shock resistance (function) N/O contact / N/C contact	> 8 / 6 g, 16ms half sine
Category of protection (IEC 61810)	RT III - wash tight
Relay weight	30 g
Packaging unit	10 pcs.

Dimensions

Dimensions in mm

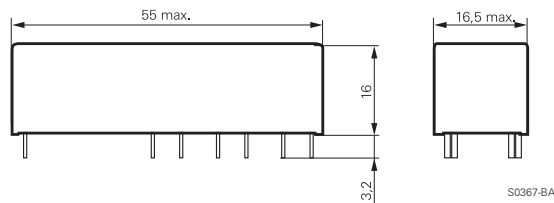

Release condition corresponds to the position shown. With positive potential on terminal A1 the relay changes to its operate position

PCB layout / terminal assignment

View on solder pins
Dimensions in mm

4 N/O+2 N/C and 3 N/O+3 N/C versions

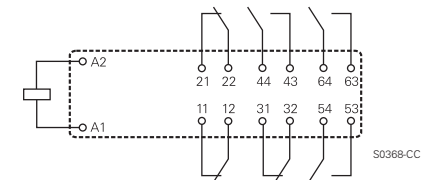
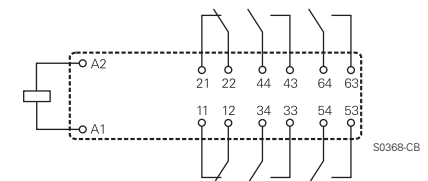
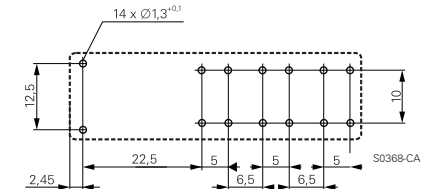

5 N/O + 1 N/C version

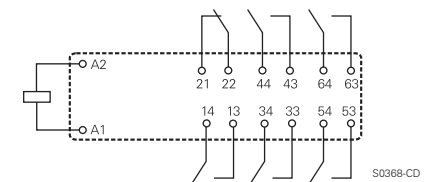
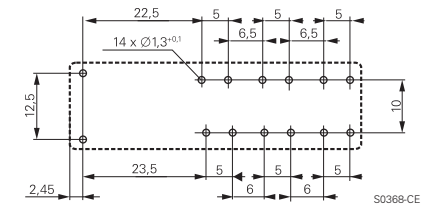

Product key

Type

Contact configuration

A 3 N/O + 3 N/C contacts

B 4 N/O + 2 N/C contacts

C 5 N/O + 1 N/C contacts

Contact material

4 AgSnO₂

Coil

S sensitive coil

Coil

DC coil code = nominal voltage (e.g. 24=24Vdc)

Other types on request

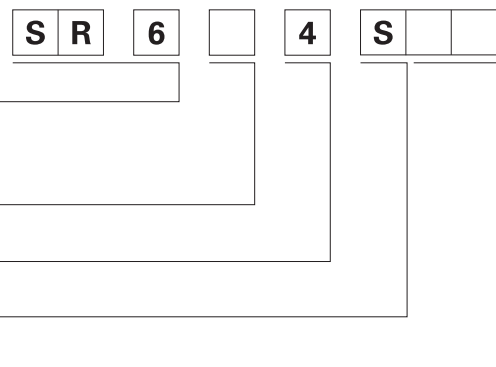

Safety Relay SR6 sensitive

6 pole 8 A

Product key	Type	Contact configuration	Contact material	Coil	Part number			
SR6A4S05	sensitive 6 pole safety relay	3 N/O + 3 N/C contacts	AgSnO	5 Vdc	0-1415057-1			
SR6A4S06				6 Vdc	1-1415057-1			
SR6A4S09				9 Vdc	2-1415057-1			
SR6A4S12				12 Vdc	3-1415057-1			
SR6A4S18				18 Vdc	4-1415057-1			
SR6A4S21				21 Vdc	5-1415057-1			
SR6A4S24				24 Vdc	6-1415057-1			
SR6A4S36				36 Vdc	7-1415057-1			
SR6A4S40				40 Vdc	8-1415057-1			
SR6A4S48				48 Vdc	9-1415057-1			
SR6B4S05				4 N/O + 2 N/C contacts			5 Vdc	0-1415056-1
SR6B4S06							6 Vdc	1-1415056-1
SR6B4S09							9 Vdc	2-1415056-1
SR6B4S12							12 Vdc	3-1415056-1
SR6B4S18							18 Vdc	4-1415056-1
SR6B4S21							21 Vdc	5-1415056-1
SR6B4S24							24 Vdc	6-1415056-1
SR6B4S36							36 Vdc	7-1415056-1
SR6B4S40	40 Vdc	8-1415056-1						
SR6B4S48	48 Vdc	9-1415056-1						
SR6C4S05	5 N/O + 1 N/C contacts						5 Vdc	0-1415058-1
SR6C4S06							6 Vdc	1-1415058-1
SR6C4S09				9 Vdc	2-1415058-1			
SR6C4S12				12 Vdc	3-1415058-1			
SR6C4S18				18 Vdc	4-1415058-1			
SR6C4S21				21 Vdc	5-1415058-1			
SR6C4S24				24 Vdc	6-1415058-1			
SR6C4S36				36 Vdc	7-1415058-1			
SR6C4S40				40 Vdc	8-1415058-1			
SR6C4S48				48 Vdc	9-1415058-1			

Safety Relay on DIN-rail SR6 Z

6 pole 8 A

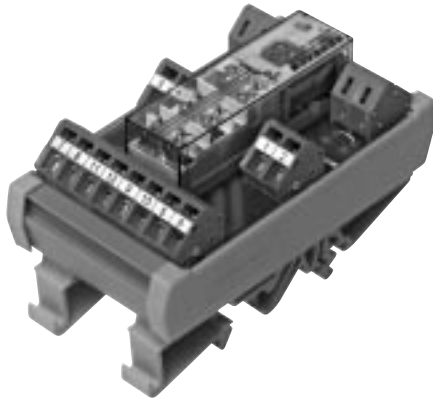

F0238-A

Features

- SR6 on printed circuit board
- AC/DC input
- Spring connectors
- Module width 46 mm

Applications

Elevator control, machine control



Technical data of approved types on request

Contact data

Type of contact	single contact, forcibly guided
Maximum switching current / continuous thermal load	8 A
Maximum switching voltage	250 Vac / Vdc
Maximum breaking capacity AC	2000 VA
Contact material	AgSnO ₂
Minimum contact load	> 50 mW
Contact resistance	≤100 mΩ / 1 A / 24 Vdc ≤20 Ω / 10 mA / 5 Vdc

Terminal assignment

DC module, 4 N/O+2 N/C version

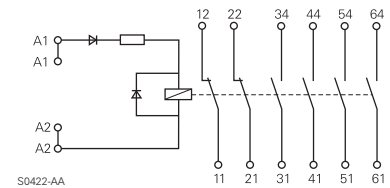

S0422-AA

Coil data

DC energizing voltage U _{nom}	6, 12, 18, 21, 24, 36, 40, 48, 60, 115 Vdc
AC/DC energizing voltage U _{nom}	12, 21, 24, 40, 48, 60, 115 Vac/Vdc
AC energizing voltage U _{nom}	230 Vac
Input circuit	bridge rectifier, series resistor
Minimum operate voltage	90% of U _{nom}
Minimum release voltage (+23°C)	≤10% of U _{nom}
Maximum permissible operating voltage	110% of U _{nom}

DC module, 3 N/O+3 N/C version

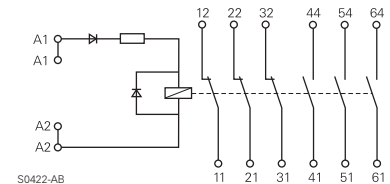

S0422-AB

Insulation

Surge voltage resistance coil-contacts	3000 V _{rms}	
	open contact circuit	1000 V _{rms}
	adjacent contacts	2000 V _{rms}
Clearance / creepage	coil-contact	5.5 / 5.5 mm
	adjacent contacts	3 / 3 mm
Insulation to IEC 60664		
Voltage rating	250 V	
Pollution degree	2	
Overtoltage category	III	

DC module, 5 N/O+1 N/C version

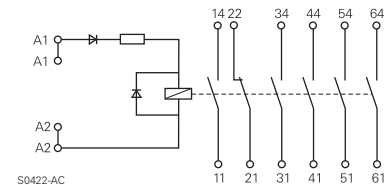

S0422-AC

AC/DC module, 4 N/O+2 N/C version

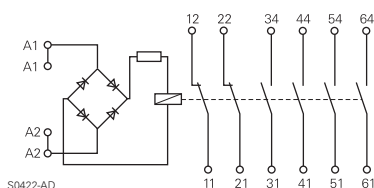

S0422-AD

AC/DC module, 3 N/O+3 N/C version

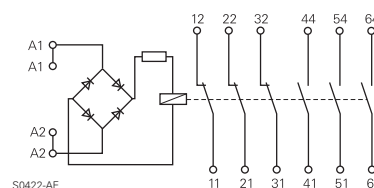

S0422-AE

AC/DC module, 5 N/O+1 N/C version

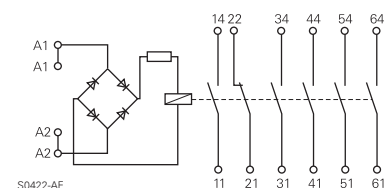

S0422-AF

Safety Relay on DIN-rail SR6 Z

6 pole 8 A

Other data

Flammability class according to UL 94	
housing	V2
housing cage clamp terminals	V0
PCB	V0
relay base	V0
relay cover	V2
Ambient temperature	-25...+50 °C
Mechanical life	≥ 10x10 ⁶ operations
Max. switching rate at rated- / minimum load	6 min ⁻¹ / 300 min ⁻¹
Connections (according IEC)	
solid wire	0.2...2.5 mm ²
stranded wire	0.2...2.5 mm ²
AWG	28...14
Installation position	any
Mounting	in rows with zero spacing
Type of connection	spring clamp connection
Relay weight	90 g
Packaging unit	2 pcs.

Dimensions

Dimensions in mm

Module width 46 mm
Module length 87 mm

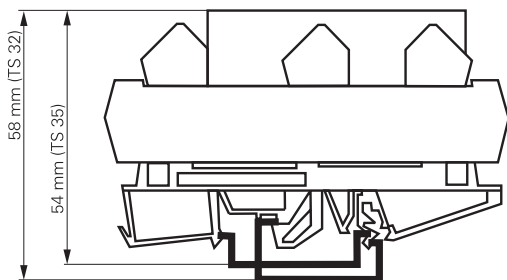

Fit onto mounting rails according to
DIN EN 50022 or DIN EN 50035

S0423-AA

Product key



Type

Contact configuration

- A** 3 N/O + 3 N/C contacts
- B** 4 N/O + 2 N/C contacts
- C** 5 N/O + 1 N/C contacts

Coil

DC coil code = nominal voltage (e.g. 024=24Vdc)
AC/DC coil code: 524=24Vac/dc, 615=115Vac/dc
AC coil code: 730=230Vac

Other types on request

Product key	Type	Contact configuration	Contact material	Coil	Part number
SR6ZA024	6-pole safety relay module	3 N/O + 3 N/C contacts	AgSnO	24 Vdc	7-1415033-1
SR6ZA524				24 Vac/dc	9-1415059-1
SR6ZA615				115 Vac/dc	0-1415060-1
SR6ZA730				230 Vac	1-1415060-1
SR6ZB024		4 N/O + 2 N/C contacts		24 Vdc	5-1415033-1
SR6ZB524				24 Vac/dc	2-1415060-1
SR6ZB615				115 Vac/dc	6-1415046-1
SR6ZB730				230 Vac	3-1415060-1
SR6ZC024		5 N/O + 1 N/C contacts		24 Vdc	3-1415042-1
SR6ZC524				24 Vac/dc	4-1415060-1
SR6ZC615				115 Vac/dc	5-1415060-1
SR6ZC730				230 Vac	6-1415060-1

Slim Interface Relay SNR

1pole 6 A



F0222-B

Features

- Module width 5.08 mm
- Cadmium-free contacts
- Sensitive coil 170 mW
- 4 kV coil-contact, 6 / 8 mm clearance/creepage
- Protection class II (VDE 0601)
- Reduced system width for increased packing density on the DIN rail
- Jumper bar

Applications

Interface technology, panel boards, mechanical engineering, process control



Technical data of approved types on request

Contact data

Configuration	1 C/O contact
Type of contact	single contact
Rated current	6 A
Rated voltage / max.breaking voltage AC	250 Vac / 440 Vac
Maximum breaking capacity AC	1500 VA
Contact material	AgSnO ₂ AgSnO ₂ gold plated
Minimum contact load	≥100 mA, 12V ≥10 mA, 5 V

Coil data

Nominal voltage	5...48 Vdc
Nominal coil power	170 mW
Operate power	75 mW
Operate category	2 / b

Coil versions

Coil code	Nominal voltage Vdc	Pull-in voltage Vdc	Release voltage Vdc	Maximum voltage Vdc	Coil resistance Ω	Coil current mA
005	5	3.5	0.25	11.2	147±10%	34.0
012	12	8.4	0.6	26.8	848±10%	14.2
024	24	16.8	1.2	53.7	3390±10%	7.1
048	48	33.6	2.4	100.0	10600±15%	4.5

All figures are given for coil without preenergization, at ambient temperature +20°C
Other coil voltages on request

Insulation

Dielectric strength	coil-contacts	4000 V _{rms}
	open contact circuit	1000 V _{rms}
Surge voltage resistance coil-contacts		6000 V (1.2 / 50 μs)
Clearance / creepage		6 / 8 mm
Insulation to IEC 60664	Voltage rating	250 V
	Pollution degree	2
	Overvoltage category	III
	Insulation to VDE 0110b (2/79)	
	Insulation category / reference voltage	C / 250
Tracking resistance of relay base		CTI 250

Max. DC load breaking capacity

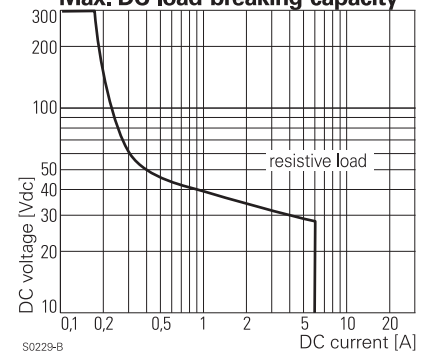

S0229-B

Electrical endurance

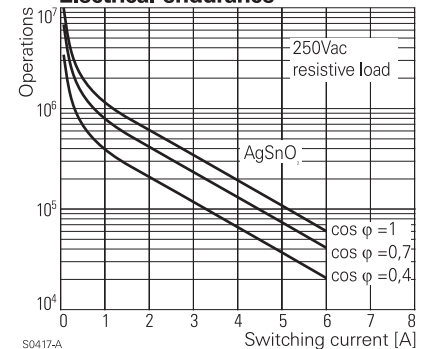

S0417-A

Coil operating range DC

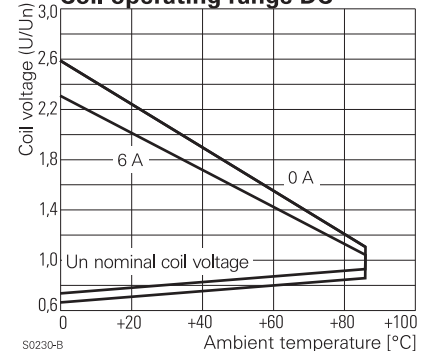

S0230-B

Slim Interface Relay SNR

1pole 6 A

Other data	
Flammability class according to UL 94	V-0
Ambient temperature relay	-40...+85 °C
package	-20...+55 °C
Mechanical life	10x10 ⁶ operations
Max. switching rate at rated- / minimum load	6 min ⁻¹ / 1200 min ⁻¹
Operate- / release time	5 / 2.5 ms
Bounce time N/O contact/N/C contact	1.5 / 5 ms
Category of protection (IEC 61810)	RT III
Relay weight	6 g
Packaging unit relay	20 pcs.
package	10 pcs.
Accessories	see accessories SNR

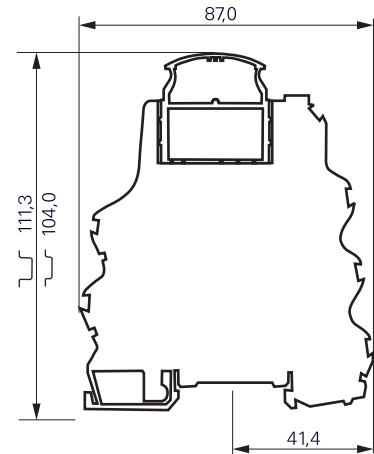

S0404-A

Product key

V 2 3 0 9 2 - A 1 - A 0 1

Type

Coil

Coil code: please refer to coil versions table

Contact material

2 AgSnO₂, gold plated **3** AgSnO₂

Contact configuration

01 1 C/O contact

Other types on request

Product key	Version	Contacts	Cont. material	Coil	Part number
V23092-A1005-A201	plug-in	1 C/O contact	AgSnO, gold plated	5 Vdc	0-1393236-1
V23092-A1005-A301	vertical version		AgSnO		0-1393236-2
V23092-A1012-A201	wash tight		AgSnO, gold plated	12 Vdc	0-1393236-4
V23092-A1012-A301			AgSnO		0-1393236-7
V23092-A1024-A201			AgSnO, gold plated	24 Vdc	2-1393236-1
V23092-A1024-A301			AgSnO		2-1393236-4
V23092-A1048-A201			AgSnO, gold plated	48 Vdc	3-1393236-5
V23092-A1048-A301			AgSnO		3-1393236-7

Available sets

Set consisting of: relay in mounting frame, mounted on socket

Product code	Part Number
ST 1P3 024 24 Vdc, AgSnO ₂ contacts	3-1415024-1
ST 1P3 L12 12 Vdc, with LED, AgSnO ₂ contacts	2-1415025-1
ST 1P3 L24 24 Vdc, with LED, AgSnO ₂ contacts	3-1415025-1
ST 1P3 L48 48 Vdc, with LED, AgSnO ₂ contacts	4-1415025-1
ST 1P2 L24 24 Vdc, with LED, AgSnO ₂ gold plated contacts	6-1415025-1

Interface Power Relay RT

1 pole 12 / 16 A, 2 pole 8 A, DC- or AC coil



F0250-A

Features

- 1 C/O 12 or 16 A or 2 C/O 8 A
- Sensitive coil 400 mW
- Cadmium-free contacts
- Protection class II (VDE 0700)
- 5 kV / 10 mm coil-contact
- 1pole 12 A with 3.5 or 5 mm pinning
- Plug-in relay with robust pins
- Recycleable packaging

Applications

Panel boards, mechanical engineering



Technical data of approved types on request

Contact data

Configuration	1 C/O contact	2 C/O contact
Type of contact	single contact	
Rated current	12 / 16 A	8 A
Rated voltage / max.breaking voltage AC	250 Vac / 440 Vac	
Maximum breaking capacity AC	3000 / 4000 VA	2000 VA
Make current (max. 4 s at duty cycle 10%)	25 / 30 A	15 A
Contact material	AgNi 90/10	
Minimum contact load	24 V, 10 mA	

Contact ratings

Type	Load	Operations	Standard
RT314	16 A, 250 Vac, C/O contact	3x10 ⁴	VDE 0435

Coil data

Nominal voltage	DC coil	6...110 Vdc
	AC coil	24...230 Vac
Nominal coil power	DC coil	400 mW
	AC coil	0.75 VA
Operate category	2 / b	

Coil versions, DC-coil

Coil code	Nominal voltage Vdc	Pull-in voltage Vdc	Release voltage Vdc	Maximum voltage Vdc	Coil resistance Ω	Coil current mA
006	6	4.2	0.6	15.3	90 ± 10%	66.7
012	12	8.4	1.2	30.6	360 ± 10%	33.3
024	24	16.8	2.4	61.2	1440 ± 10%	16.7
048	48	33.6	4.8	122.4	5520 ± 10%	8.7
060	60	42.0	6.0	153.0	7340 ± 12%	8.1
110	110	77.0	11.0	280.5	26600 ± 12%	4.1

All figures are given for coil without preenergization, at ambient temperature +20°C

Other coil voltages on request

Max. DC load breaking capacity

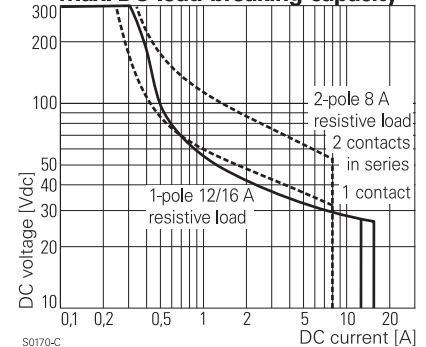

S0170-C

Electrical endurance

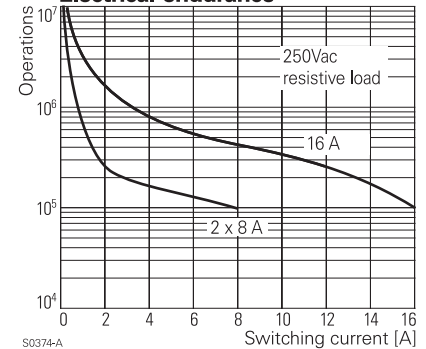

S0374-A

Coil operating range DC

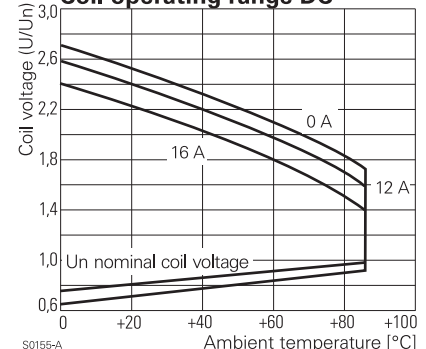

S0155-A

Interface Power Relay RT

1 pole 12 / 16 A, 2 pole 8 A, DC- or AC coil

Coil versions, AC-coil

Coil code	Nominal voltage Vac	Pull-in voltage Vac	Release voltage Vac	Maximum voltage Vac	Coil resistance Ω	Coil current mA
524	24	18.0	7.2	36.0	350 ± 10%	31.6
615	115	86.3	34.5	172.5	8100 ± 15%	6.6
730	230	172.5	69.0	345.0	32500 ± 15%	3.2

All figures are given for coil without preenergization, at ambient temperature +20°C
Other coil voltages on request

Insulation

Dielectric strength	coil-contacts	5000 V _{rms}
	open contact circuit	1000 V _{rms}
	adjacent contacts	2500 V _{rms}
Clearance / creepage		≥ 10 / 10 mm
Insulation to IEC 60664		
Voltage rating		250 V
Pollution degree		3
Overvoltage category		III
Insulation to VDE 0110b (2/79)		
Insulation category / reference voltage		C / 250
Tracking resistance of relay base		CTI 250

Other data

	1 C/O contact	2 C/O contact
Flammability class according to UL 94	V-0	
Ambient temperature	-40...+70°C	
Mechanical life DC-coil	>30x10 ⁶ ops.	>30x10 ⁶ ops.
AC-coil	>10x10 ⁶ ops.	>5x10 ⁶ ops.
Max. switching rate at rated- / minimum load	6 min ⁻¹ / 1200 min ⁻¹	
Operate- / release time DC-coil	typ. 7 / 3 ms	typ. 7 / 2 ms
Bounce time N/O contact/N/C contact	typ. 1 / 3 ms	typ. 1 / 3 ms
Vibration resistance N/O / N/C contact	>10 / 5 g; 30...150 Hz	
Shock resistance (destruction)	>100 g	
Category of protection (IEC 61810)	RT II	
Relay weight	14 g	
Packaging unit	20 / 500 pcs.	
Accessories	see accessories RT	

Coil operating range AC

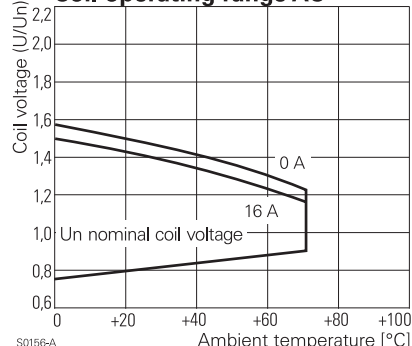

Terminal assignment

View on pins

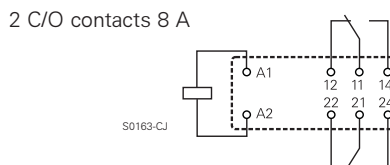
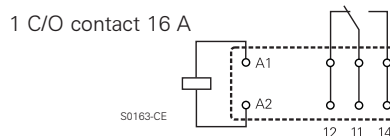
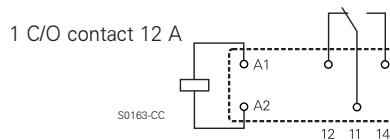

Dimensions

Dimensions in mm

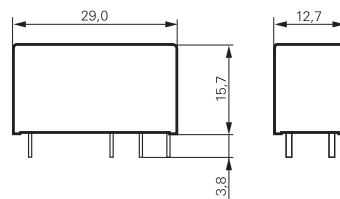

S0272-AA

Product key

Type

Version

1 1-pole, 12 A, pinning 3.5 mm **3** 1-pole, 16 A, pinning 5 mm
2 1-pole, 12 A, pinning 5 mm **4** 2-pole, 8 A, pinning 5 mm

Contact configuration

1 1 C/O contact **2** 2 C/O contacts

Contact material

4 AgNi 90/10

Coil

Coil code: please refer to coil versions table, preferred types in bold print

Washable version on request

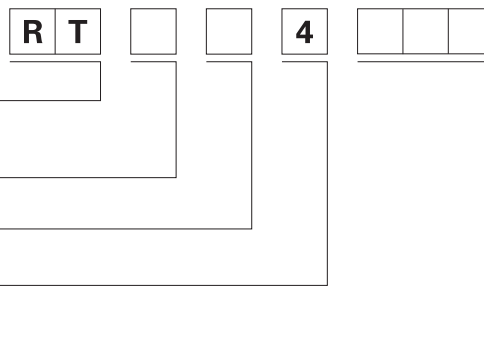

Interface Power Relay RT

1 pole 12 / 16 A, 2 pole 8 A, DC- or AC coil

Product key	Version	Contacts	Cont. material	Coil	Coil	Part number
RT114024	1-pole, 12 A pinning 3.5 mm	1 C/O contact	AgNi 90/10	DC-coil	24 Vdc	1-1393239-3
AC-coil				24 Vac	1-1393239-7	
				115 Vac	1-1393239-8	
				230 Vac	1-1393239-9	
RT214024	1-pole, 12 A pinning 5 mm			DC-coil	24 Vdc	5-1393239-5
AC-coil				24 Vac	5-1393239-9	
				115 Vac	6-1393239-0	
				230 Vac	0-1419108-6	
RT314024	1-pole, 16 A pinning 5 mm			DC-coil	24 Vdc	9-1393239-8
AC-coil				24 Vac	0-1393240-4	
				115 Vac	0-1393240-6	
				230 Vac	0-1393240-7	
RT424024	2-pole, 8 A pinning 5 mm	2 C/O contacts		DC-coil	24 Vdc	6-1393243-8
AC-coil				24 Vac	7-1393243-6	
				115 Vac	7-1393243-8	
				230 Vac	7-1393243-9	

Miniature Relay PT

2 pole 12 A, 3 pole 10 A or 4 pole 6 A
DC- or AC-coil



F0191-A

Features

- 2, 3 or 4 C/O contacts
- Switching performance up to 3000 VA
- Relay height 29 mm
- Cadmium-free contact material
- Mechanical and electrical indicator
- Manual test tab, optionally lockable.
- White marking tabs

Applications

Universal use in control and automation



Technical data of approved types on request

Contact data	PT2	PT3	PT5
Configuration	2 C/O	3 C/O	4 C/O
Type of contact	single contacts		
Rated current	12 A	10 A	6 A
Rated voltage / max.breaking voltage AC	250 Vac	250 Vac	250 Vac
Maximum switching voltage	440 Vac	440 Vac	250 Vac
Maximum breaking capacity AC	3000 VA	2500 VA	1500 VA
Make current	24 A	20 A	12 A
Contact material	AgNi 90/10, AgNi 90/10 gold plated		
Minimum contact load	24 V, 10 mA / 20 mV, 1 mA gold plated		

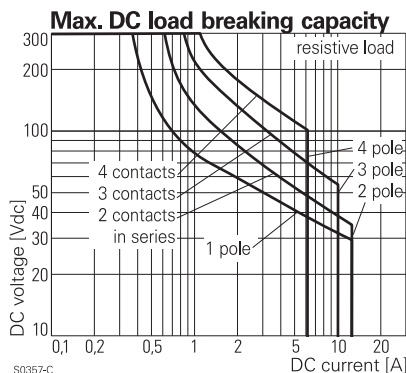

Contact ratings

Type	Load	Operations	Standard
PT570	6 A, 250 Vac, on the C/O contact	1x10 ⁵	VDE 0435

Coil data

Nominal voltage	DC coil	6...220 Vdc
	AC coil	6...230 Vac
Nominal coil power	DC coil	typ. 0.75 W
	AC coil	typ. 1.0 VA
Operate category	2 / b	
Operating range for AC coil 60Hz at 70°C	90...110% U _{nom}	

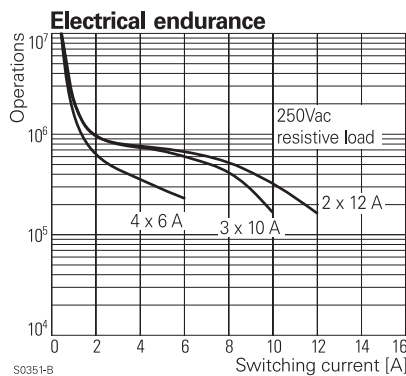

Coil versions, DC-coil

Coil code	Nominal voltage	Pull-in voltage	Release voltage	Coil resistance	Coil current	
Standard	LED bipolar	Vdc	Vdc	Ω	mA	
006	L06	6	4.5	0.6	48±10%	125.0
012	L12	12	9.0	1.2	192±10%	62.5
024	L24	24	18.0	2.4	777±10%	31.3
048	L48	48	36.0	4.8	3072±10%	15.6
060	L60	60	45.0	6.0	4845±12%	12.5
110	M10	110	82.5	11.0	16133±15%	6.8
220	N20	220	165.0	22.0	64533±15%	3.4

All figures are given for coil without preenergization, at ambient temperature +20°C

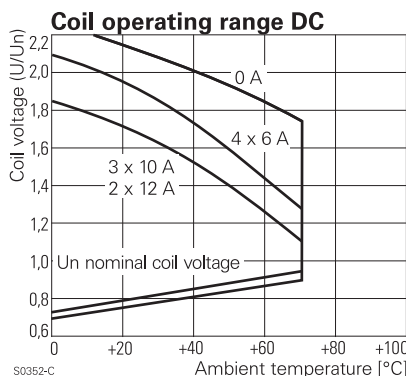

Miniature Relay PT

2 pole 12 A, 3 pole 10 A or 4 pole 6 A
DC- or AC-coil

Coil versions, AC-coil

Coil code		Nominal voltage	Pull-in voltage	Release voltage	Coil resistance	Coil current
Standard	LED	Vac	Vac	Vac	Ω	mA
506	R06	6	4.8	1.8	$11 \pm 10\%$	166.5
512	R12	12	9.6	3.6	$48 \pm 10\%$	83.3
524	R24	24	19.2	7.2	$192 \pm 10\%$	41.6
548	R48	48	38.4	14.4	$777 \pm 10\%$	21.3
560	R60	60	48.0	18.0	$1306 \pm 10\%$	16.7
615	S15	115	92.0	34.5	$4845 \pm 12\%$	8.8
730	T30	230	184.0	69.0	$19465 \pm 15\%$	4.3

All figures are given for coil without preenergization, at ambient temperature +20°C

Coil operating range AC

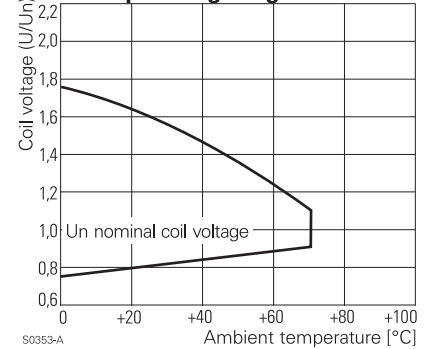

Insulation	PT2	PT3	PT5
Dielectric strength coil-contacts	2500 V _{rms}	2500 V _{rms}	2500 V _{rms}
open contact circuit in unenergized position typ.	1500 V _{rms}	1500 V _{rms}	1500 V _{rms}
adjacent contacts	2500 V _{rms}	2500 V _{rms}	2000 V _{rms}
Clearance / creepage	3 / 4 mm	2.6 / 4 mm	1.8 / 3 mm
Insulation to IEC 60664			
Voltage rating	240 V	240 V	240 V
Pollution degree	3	3	2
Overvoltage category	III	III	III
Insulation to VDE 0110b (2/79)			
Insulation category / ref. voltage	C / 250	C / 250	B / 250
Tracking resistance of relay base		CTI 175	

Other data

Flammability class according to UL 94	V-0
Ambient temperature	DC-coil -40...+70 °C AC-coil -40...+70 °C
Mechanical life	DC-coil >30x10 ⁶ ops. AC-coil >20x10 ⁶ ops.
Max. switching rate at rated- / minimum load	6 min ⁻¹ / 600 min ⁻¹
Operate- / release time	15 / 10 ms
Bounce time	5 ms
Vibration resistance N/O contact/N/C contact	>7 / 4 g
Shock resistance (function) N/O contact/N/C contact	>20 / 5 g
Category of protection (IEC 61810)	RT II
Relay weight	30 g
Packaging unit	10 pcs.
Accessories	see accessories PT

Miniature Relay PT

2 pole 12 A, 3 pole 10 A or 4 pole 6 A
DC- or AC-coil

PCB layout / terminal assignment

View on solder pins
Dimensions in mm

4-pole

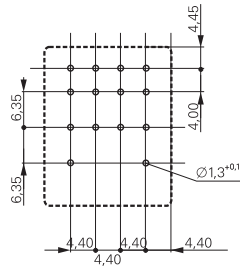

S0354-AA

3-pole

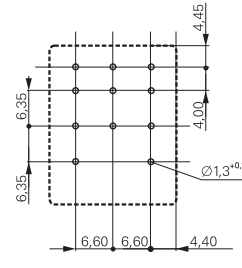

S0354-AB

2-pole

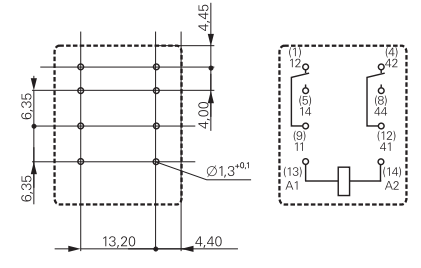

S0354-AE

S0354-AC

S0354-AF

Dimensions

Dimensions in mm

Solder- and plug-in terminals (standard version)

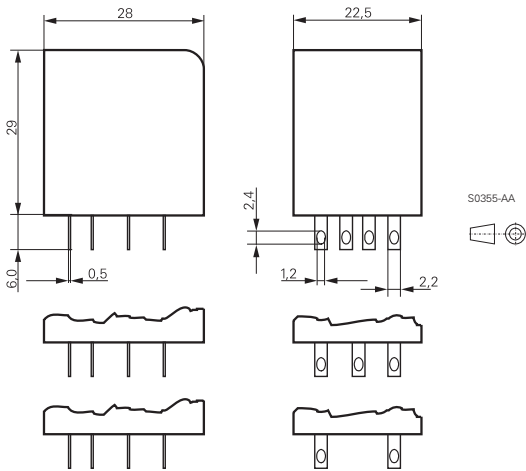

PCB version

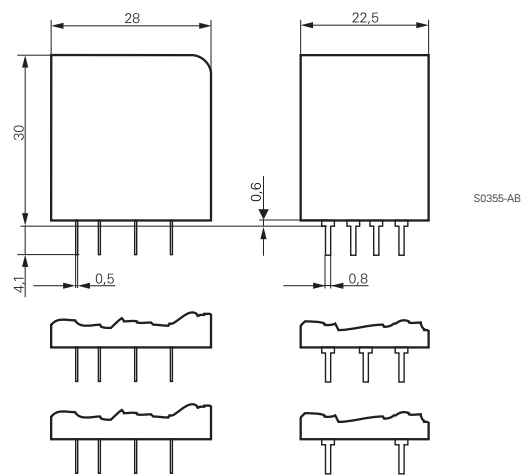

Product key

Type

Contact configuration

- 2** 2 C/O contacts
- 3** 3 C/O contacts
- 5** 4 C/O contacts

Contact material

- 7** AgNi 90/10, with test button*)
- 8** AgNi 90/10, gold plated, with test button*)

Version

- 0** standard, AMP 2.8
- 1** PCB terminals

Coil

Coil code: please refer to coil versions table, preferred types in bold print

*) Version with closed cap without test button available on request.

Other types on request.

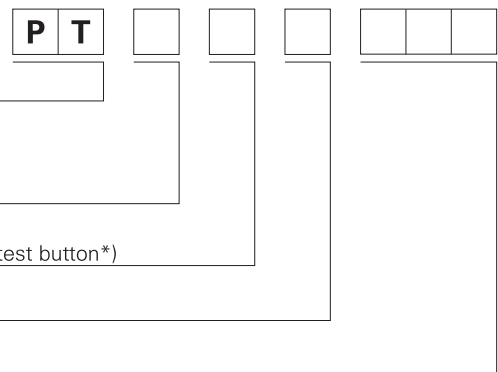

Miniature Relay PT

2 pole 12 A, 3 pole 10 A or 4 pole 6 A
DC- or AC-coil

Product key	Cont. config.	Cont. material	Version	Coil	Coil	Part number			
PT270024	2 C/O contacts	AgNi 90/10 test button	AMP 2.8 connectors	DC coil	24 Vdc	4-1419111-2			
PT270524				AC-coil	24 Vac	4-1419111-8			
PT270615					115 Vac	5-1419111-0			
PT270730					230 Vac	5-1419111-1			
PT270L24					DC coil+LED	24 Vdc	9-1415001-1		
PT270R24					AC-coil+LED	24 Vac	0-1415002-1		
PT270S15						115 Vac	2-1415039-1		
PT270T30						230 Vac	3-1415002-1		
PT271024						PCB terminals	DC coil	24 Vdc	5-1419111-3
PT271524							AC-coil	24 Vac	5-1419111-6
PT271615					115 Vac	4-1419135-0			
PT271730					230 Vac	5-1419111-8			
PT370024	3 C/O contacts	AgNi 90/10 test button	AMP 2.8 connectors	DC coil	24 Vdc	6-1419111-1			
PT370524				AC-coil	24 Vac	6-1419111-6			
PT370615					115 Vac	6-1419111-8			
PT370730					230 Vac	6-1419111-9			
PT370L24					DC coil+LED	24 Vdc	5-1415002-1		
PT370R24					AC-coil+LED	24 Vac	7-1415002-1		
PT370S15						115 Vac	9-1415039-1		
PT370T30						230 Vac	9-1415002-1		
PT371024						PCB terminals	DC coil	24 Vdc	7-1419111-1
PT371524							AC-coil	24 Vac	7-1419111-3
PT371615					115 Vac	0-1393154-8			
PT371730					230 Vac	7-1419111-5			
PT570024	4 C/O contacts	AgNi 90/10 test button	AMP 2.8 connectors	DC coil	24 Vdc	1-1393154-2			
PT570524				AC-coil	24 Vac	8-1419111-7			
PT570615					115 Vac	9-1419111-0			
PT570730					230 Vac	9-1419111-1			
PT570L24					DC coil+LED	24 Vdc	6-1415001-1		
PT570R24					AC-coil+LED	24 Vac	7-1415001-1		
PT570S15						115 Vac	7-1415003-1		
PT570T30						230 Vac	8-1415001-1		
PT571024						PCB terminals	DC coil	24 Vdc	9-1419111-3
PT571524							AC-coil	24 Vac	9-1419111-6
PT571615					115 Vac	1-1393154-5			
PT571730					230 Vac	9-1419111-8			
PT580024		AgNi 90/10 gold plated test button	AMP 2.8 connectors	DC coil	24 Vdc	1-1393154-7			
PT580524	AC-coil			24 Vac	2-1393154-1				
PT580730				230 Vac	2-1393154-2				
PT580L24				DC coil+LED	24 Vdc	5-1415026-1			
PT580R24				AC-coil+LED	24 Vac	6-1415026-1			
PT580T30					230 Vac	7-1415026-1			
PT581024					PCB terminals	DC coil	24 Vdc	7-1419135-2	
PT581730						AC-coil	230 Vac	2-1393154-3	

Miniature Power Relay PCLH

2 pole 10 A, DC- or AC-coil



Features

- 2 C/O contacts
- 10 A rated current
- DC- or AC-coil
- Plug-in version, PCB or chassis mount version

Applications

Panel boards, domestic appliances

F0162-A



Technical data of approved types on request

Contact data

Configuration	2 C/O contact
Type of contact	single contact
Rated current	10 A
Rated voltage / max.breaking voltage AC	250 Vac / 250 Vac
Maximum breaking capacity AC	2500 VA
Make current (max. 4 s at duty cycle 10%)	15 A
Contact material	AgCdO

Coil data

Nominal voltage	DC coil	12...48 Vdc
	AC coil	12...230 Vac
Nominal coil power	DC coil	900 mW
	AC coil	1.2 VA

Electrical endurance

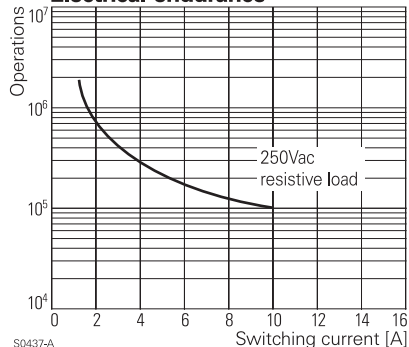

Coil versions, DC-coil

Coil code	Nominal voltage Vdc	Pull-in voltage Vdc	Release voltage Vdc	Coil resistance Ω	Coil current mA
02D	12	9.6	1.2	160 \pm 10%	75.0
03D	24	19.2	2.4	650\pm10%	37.2
04D	48	38.4	4.8	2600 \pm 10%	18.5

All figures are given for coil without preenergization, at ambient temperature +20°C

Coil versions, AC-coil

Coil code	Nominal voltage Vac	Pull-in voltage Vac	Release voltage Vac	Coil resistance Ω	Coil current mA
02A	12	9.6	3.6	40 \pm 10%	101.7
03A	24	19.2	7.2	160\pm10%	50.0
04A	48	38.4	14.4	600 \pm 10%	25.4
06A	115	92.0	34.5	3400 \pm 10%	10.5
08A	230	184.0	69.0	13600\pm10%	5.3

All figures are given for coil without preenergization, at ambient temperature +20°C

Coil operating range DC

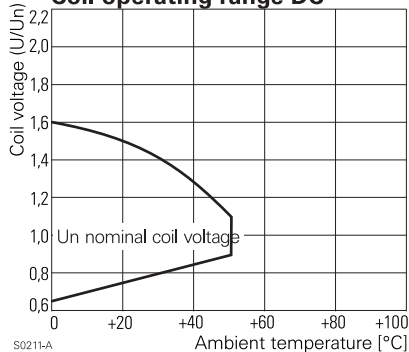

Insulation

Dielectric strength	coil-contacts	1500 V _{rms}
	open contact circuit	1000 V _{rms}
	adjacent contacts	1500 V _{rms}
Clearance / creepage		>1.2 / 1.2 mm

Miniature Power Relay PCLH

2 pole 10 A, DC- or AC-coil

Other data

Flammability class according to UL 94	V-0
Ambient temperature	-10...+55 °C
Mechanical life	>10x10 ⁶ operations
Max. switching rate at rated- / minimum load	30 min ⁻¹ / 300 min ⁻¹
Operate- / release time	15 / 5 ms
Vibration resistance	10...55 Hz, 1 mm double amplitude
Shock resistance (function)	>10 g
Shock resistance (destruction)	>100 g
Category of protection (IEC 61810)	RT I
Relay weight	32 g
Packaging unit	50 / 500 pcs.
Accessories	see accessories PCLH

PCB layout / terminal assignment

View on solder pins
Dimensions in mm

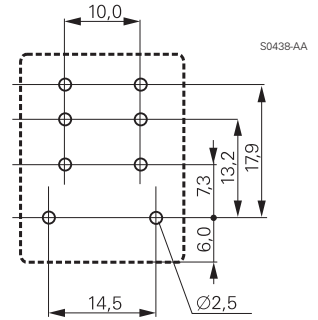

Dimensions

Dimensions in mm

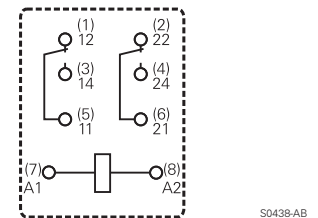
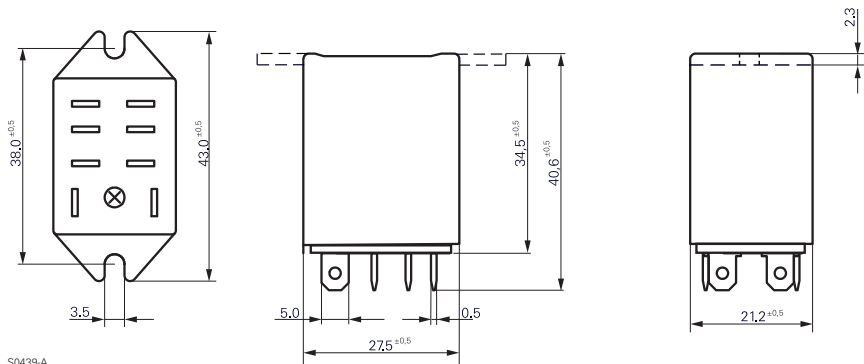

Product key



Type

Number of contacts

2 2 C/O contact, dust protected

Coil

Coil code: please refer to coil versions table

Contact material

1 AgCdO

Enclosure

- S** case with AMP-Faston 187 terminals
- F** case for flange mount, AMP-Faston 187
- SP** case with PCB terminals

Other types on request

Product key	Cont. Config.	Cont. material	Enclosure	Coil	Coil	Part number		
PCLH-203D1S	2 C/O contacts dust-protected	AgCdO Faston terminals	AMP 187	DC-coil	24 Vdc	7-1440007-1		
PCLH-203A1S				AC-coil	24 Vac	6-1461068-3		
PCLH-206A1S					115 Vac	5-1461068-8		
PCLH-208A1S					230 Vac	7-1440007-5		
PCLH-203D1F					flange mount AMP 187	DC-coil	24 Vdc	5-1461068-0
PCLH-203A1F						AC-coil	24 Vac	4-1461068-2
PCLH-206A1F	Faston terminals				115 Vac	4-1461068-5		
PCLH-208A1F					230 Vac	1-1440009-6		
PCLH-203D1SP			PCB terminals	DC-coil	24 Vdc	5-1461059-5		
PCLH-203A1SP					AC-coil	24 Vac	6-1461059-3	
PCLH-206A1SP					115 Vac	5-1461059-8		
PCLH-208A1SP					230 Vac	6-1461059-0		

Multimode Relay MT

2 / 3 pole 10 A, DC- or AC-coil



Features

- 2 C/O or 3 C/O contacts
- Cadmium-free contacts
- DC and AC coils
- Mechanical indicator as standard
- Electrical indicator
- New test system with front operated finger protected push-to-test button and integral locking test tab
- White write on panel

Applications

Mechanical engineering, plant control



Technical data of approved types on request

Contact data

Configuration	2 C/O contact or 3 C/O contact	
Type of contact	single contacts	bifurcated contacts
Rated current	10 A	4 A
Rated voltage / max.breaking voltage AC	250 Vac / 440 Vac	
Maximum breaking capacity AC	2500 VA	500 VA
Make current (max. 4 s at duty cycle 10%)	20 A	8 A
Contact material	AgNi 90/10	
Minimum contact load	24 V, 10 mA / 20 mV, 1 mA gold plated	

Contact ratings

Type	Load	Operations	Standard
MT321	10 A, 250 Vac, C/O contact	1x10 ⁵	VDE 0435

Coil data

Nominal voltage	DC coil	6...220 Vdc
	AC coil	6...230 Vac
Nominal coil power	DC coil	typ. 1.2 W
	AC coil	typ. 2.3 VA
Operate category	1 / a	

Coil versions, DC-coil

Coil code standard	PD*	Nominal voltage Vdc	Pull-in voltage Vdc	Release voltage Vdc	Coil resistance Ω	Coil current mA
006	0A6	6	4.5	0.6	32±10%	187.5
012	0B2	12	9.0	1.2	110±10%	109.1
024	0C4	24	18.0	2.4	475±10%	50.5
048	0E8	48	36.0	4.8	2000±10%	24.0
060	0G0	60	45.0	6.0	2850±10%	21.1
110	1B0	110	82.5	11.5	10000±12%	11.0
220	2C0	220	165.0	22.0	40000±15%	5.5

All figures are given for coil without preenergization, at ambient temperature +20°C

* Protection diode PD; standard polarity: 2-pole relays: +2 / -7, 3-pole relays: +2 / -10

Max. DC load breaking capacity

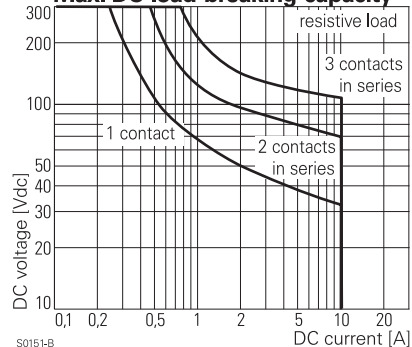

S0151-B

Electrical endurance

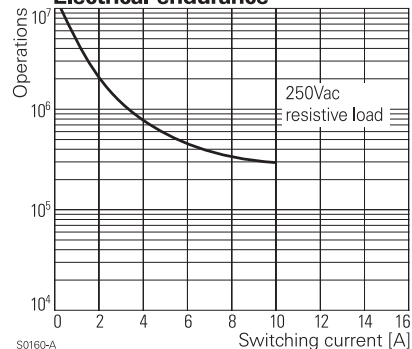

S0160-A

Coil operating range DC

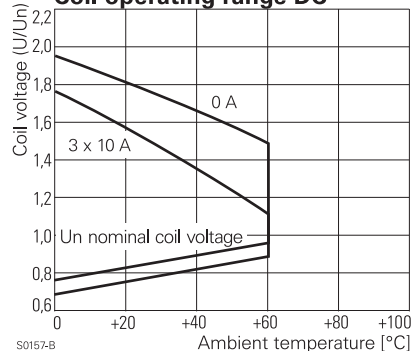

S0157-B

Multimode Relay MT

2 / 3 pole 10 A, DC- or AC-coil

Coil versions, AC-coil

Coil code	Nominal voltage Vac	Pull-in voltage Vac	Release voltage Vac	Maximum voltage Vac	Coil resistance Ω	Coil current mA
006	6	4.8	2.4	7.8	$5.3 \pm 10\%$	381.7
012	12	9.6	4.8	15.6	$24 \pm 10\%$	182.5
024	24	19.2	9.6	31.2	$86 \pm 10\%$	94.2
048	48	38.4	19.2	62.4	$345 \pm 10\%$	47.5
060	60	48.0	24.0	78.0	$544 \pm 10\%$	37.8
115	115	92.0	46.0	149.5	$2000 \pm 10\%$	20.6
230	230	184.0	92.0	299.0	$8300 \pm 12\%$	10.1

All figures are given for coil without preenergization, at ambient temperature +20°C

Coil operating range AC

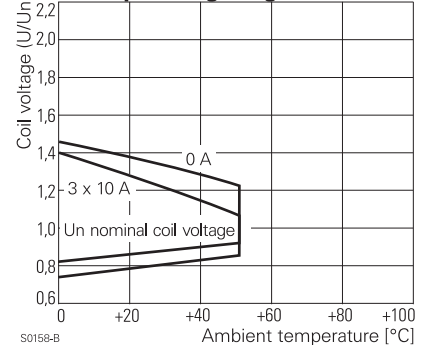

Insulation

Dielectric strength	coil-contacts	2500 V_{rms}
	open contact circuit	1500 V_{rms}
	adjacent contacts	2500 V_{rms}
Clearance / creepage		2.8 / 4 mm
Insulation to IEC 60664		
	Voltage rating	250 V
	Pollution degree	3
	Overvoltage category	III
Insulation to VDE 0110b (2/79)		C / 250
Tracking resistance of relay base		CTI 175

Other data

Flammability class according to UL 94		V-0
Ambient temperature	DC-coil	-45...+60 °C
	AC-coil	-45...+50 °C
Mechanical life		>20x10 ⁶ operations
Max. switching rate at rated- / minimum load		20 min ⁻¹ / 100 min ⁻¹
Operate- / release time		12 / 5 ms
Bounce time		4 ms
Vibration resistance N/O / N/C contact		>5 / 2 g
Shock resistance (function) N/O contact / N/C contact		>50 / 10 g
Category of protection (IEC 61810)		RT I - dust protected
Relay weight		80 g
Packaging unit		25 pcs.
Accessories		see accessories MT

Terminal assignment

View on solder pins

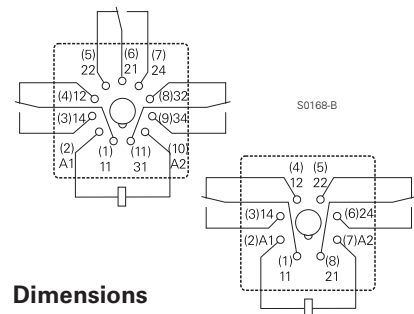

Dimensions

Dimensions in mm

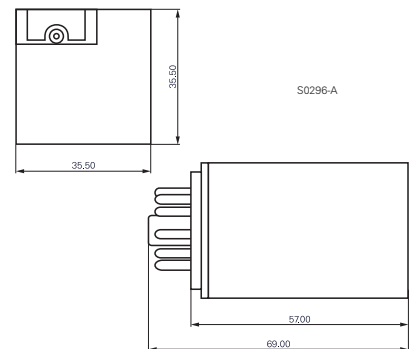

Product key

Type	MT				
Contact configuration	2	2 C/O contacts, 8-pole	3	3 C/O contacts, 11-pole	
Contact material	2	AgNi 90/10	B	AgNi 90/10, bifurcated contacts, gold plated	
	3	AgNi 90/10, gold plated			
Version	1	DC with test button	6	AC with test button	
	3	DC with test button and bipolar LED	8	AC with test button and LED	
Coil	Coil code: please refer to coil versions table, preferred types in bold print				
Other types on request					

Multimode Relay MT

2 / 3 pole 10 A, DC- or AC-coil

Product key	Contact configuration	Contact material	Version	Coil	Part number		
MT221012	2 C/O contacts 8 pole	AgNi 90/10	DC with test button	12 Vdc	4-1393090-9		
MT221024				24 Vdc	5-1393090-0		
MT221048			48 Vdc	5-1393090-1			
MT221060			60 Vdc	5-1393090-2			
MT221110			110 Vdc	5-1393090-3			
MT221220			220 Vdc	5-1393090-4			
MT223024			DC+LED+test button	24 Vdc	5-1393090-7		
MT226012				AC 12 Vac	6-1393090-3		
MT226024			test button	24 Vac	6-1393090-4		
MT226048				48 Vac	6-1393090-5		
MT226115			115 Vac	6-1393090-7			
MT226230			230 Vac	6-1393090-8			
MT228024			AC+LED test button	24 Vac	6-1393090-9		
MT228115				115 Vac	7-1393090-0		
MT228230			230 Vac	7-1393090-1			
MT321012			3 C/O contacts 11 pole	AgNi 90/10	DC with test button	12 Vdc	6-1393091-8
MT321024						24 Vdc	7-1393091-0
MT321048					48 Vdc	7-1393091-1	
MT321060					60 Vdc	7-1393091-2	
MT321110					110 Vdc	7-1393091-4	
MT321220	220 Vdc	7-1393091-7					
MT323024	DC+LED+test button	24 Vdc			8-1393091-4		
MT3230C4	DC+LED+PD+TB	24 Vdc			7-1393091-9		
MT326012	AC test button	12 Vac			9-1393091-6		
MT326024		24 Vac			9-1393091-7		
MT326048	48 Vac	9-1393091-8					
MT326115	115 Vac	0-1393092-1					
MT326230	230 Vac	0-1393092-2					
MT328024	AC+LED test button	24 Vac			0-1393092-4		
MT328115		115 Vac			0-1393092-7		
MT328230	230 Vac	0-1393092-8					
MT331024	AgNi 90/10 gold plated	DC with test button			24 Vdc	1-1393092-1	
MT331110					110 Vdc	1-1393092-3	
MT331220		220 Vdc			1-1393092-5		
MT333024		DC+LED+test button			24 Vdc	1-1393092-8	
MT3330C4		DC+LED+PD+TB	24 Vdc	1-1393092-6			
MT333110		DC+LED	110 Vdc	2-1393092-0			
MT333220		test button	220 Vdc	2-1393092-2			
MT336115		AC test button	115 Vac	2-1393092-5			
MT336230			230 Vac	2-1393092-6			
MT338024		AC+LED	24 Vac	2-1393092-7			
MT338115		test button	115 Vac	8-1415025-1			
MT338230			230 Vac	2-1393092-8			

Power Relay RM 2/3/7

2 / 3 pole 10 / 16 A, DC- or AC-coil



Features

- 2 C/O or 3 C/O contacts
- Switching capacity up to 6000 VA
- DC- or AC-coil
- Mechanical indicator
- Push-to-test-button
- Plug-in version, PCB terminals, chassis- or DIN-rail mount

Applications

Elevator control, power supplies



Technical data of approved types on request

F0163-A

Contact data	RM 2	RM 3	RM 7
Configuration	2 C/O	3 C/O	3 C/O
Type of contact	single contact		
Rated current	16 A	10 A	16 A
Rated voltage / max. breaking voltage AC	380 Vac / 440 Vac		
Maximum breaking capacity AC	6000 VA	3800 VA	6000 VA
Make current	40 A	40 A	40 A
Contact material	AgCdO		

Contact ratings

Type	Load	Standard
RM2	1hp, 240 Vac, per contact	UL 508
RM7	1.5hp, 240 Vac, 3-phase	UL 508
RM7	15 A, 250 Vac, per contact	UL 508
RM3	1 / 2hp, 240 Vac, per contact	UL 508
RM3	10 A, 240 Vac, per contact	UL 508

Coil data		RM 2	RM 3	RM 7
Nominal voltage	DC coil		6...220 Vdc	
	AC coil		6...400 Vac	
Nominal coil power	DC coil	1.2 W	1.2 W	1.6 W
	AC coil	2.3 VA	2.3 VA	2.8 VA

Coil versions, DC-coil, RM2, RM3

Coil code	Nominal voltage	Pull-in voltage	Release voltage	Coil resistance	Coil current
STD bipolar	Vdc	Vdc	Vdc	Ω	mA
006 L06 OA6 LA6	6	4.5	0.6	32±10%	187.5
012 L12 OB2 LB2	12	9.0	1.2	110±10%	109.1
024 L24 OC4 LC4	24	18.0	2.4	475±10%	50.5
048 L48 OE8 LE8	48	36.0	4.8	2000±10%	24.0
060 L60 OG0 LG0	60	45.0	6.0	2850±10%	21.1
110 M10 1B0 MB0	110	82.5	11.0	10000±12%	11.0
221 N21 2C1 NC1	220	165.0	22.0	40000±15%	5.5

Coil versions, DC-coil, RM7

006 L06 OA6 LA6	6	4.5	0.6	24±10%	250.0
012 L12 OB2 LB2	12	9.0	1.2	86±10%	139.5
024 L24 OC4 LC4	24	18.0	2.4	345±10%	69.6
048 L48 OE8 LE8	48	36.0	4.8	1340±10%	35.8
060 L60 OG0 LG0	60	45.0	6.0	2200±10%	27.3
110 M10 1B0 MB0	110	82.5	11.0	7300±10%	15.1
221 N21 2C1 NC1	220	165.0	22.0	30000±15%	7.3

All figures are given for coil without preenergization, at ambient temperature +20°C

* Protection diode PD; standard polarity: +A1 / -A2

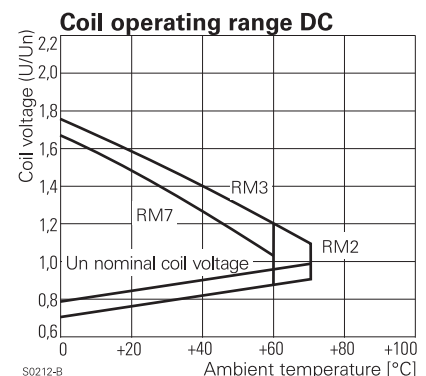
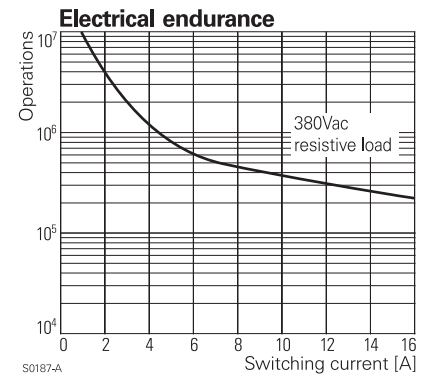
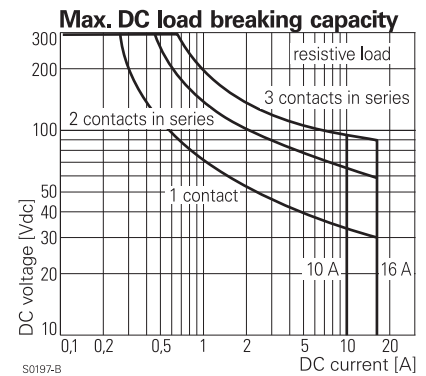

Power Relay RM 2/3/7

2 / 3 pole 10 / 16 A, DC- or AC-coil

Coil versions, AC-coil, RM2, RM3

Coil code	LED	Nominal voltage Vac	Pull-in voltage Vac	Release voltage Vac	Coil resistance Ω	Coil current mA
506	R06	6	4.8	2.4	$5.3 \pm 10\%$	381.7
512	R12	12	9.6	4.8	$24 \pm 10\%$	182.5
524	R24	24	19.2	9.6	$86 \pm 10\%$	94.2
548	R48	48	38.4	19.2	$345 \pm 10\%$	47.5
560	R60	60	48.0	24.0	$544 \pm 10\%$	37.8
615	S15	115	92.0	46.0	$2000 \pm 10\%$	20.6
730	T30	230	184.0	92.0	$8300 \pm 12\%$	10.1
900	V00	400	320.0	160.0	$27500 \pm 15\%$	5.8

Coil versions, AC-coil, RM7

506	R06	6	4.8	2.4	$4.7 \pm 10\%$	476.7
512	R12	12	9.6	4.8	$19.5 \pm 10\%$	225.8
524	R24	24	19.2	9.6	$80 \pm 10\%$	109.2
548	R48	48	38.4	19.2	$320 \pm 10\%$	54.2
560	R60	60	48.0	24.0	$500 \pm 10\%$	43.7
615	S15	115	92.0	46.0	$1850 \pm 10\%$	23.0
730	T30	230	184.0	92.0	$7500 \pm 10\%$	11.7
900	V00	400	320.0	160.0	$23500 \pm 15\%$	6.5

All figures are given for coil without preenergization, at ambient temperature +20°C

Coil operating range AC

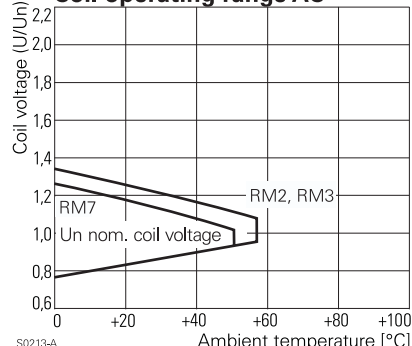

S0213-A

PCB layout / terminal assignment

View on solder pins
Dimensions in mm

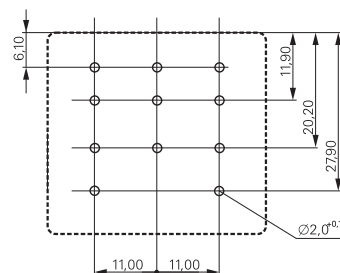

S0269-AA

Insulation

Dielectric strength	coil-contacts	2500 V _{rms}
	open contact circuit	1500 V _{rms}
	adjacent contacts	2500 V _{rms}
Clearance / creepage		≥ 3.5 / 6 mm
Insulation to VDE 0110b (2/79)		
Insulation category / reference voltage		C / 400 with fully isolated Faston connectors

Other data

	RM 2	RM 3	RM 7
Ambient temperature DC-coil	-45...+70 °C	-45...+60 °C	-45...+60 °C
AC-coil	-45...+55 °C	-45...+55 °C	-45...+50 °C
Mechanical life	>20x10 ⁶ operations		
Max. switching rate at rated- / minimum load	16 min ⁻¹ / 100 min ⁻¹		
Operate- / release time	approx. 15 / 10 ms		
Bounce time	approx. 3 ms		
Vibration resistance N/O / N/C contact	>5 / 2 g	>5 / 2 g	>12 / 4 g
Category of protection (IEC 61810)	RT I - dust protected		
Relay weight	81 g		
Packaging unit	10 / 25 pcs.		
Accessories	see accessories RM		

3 C/O contacts

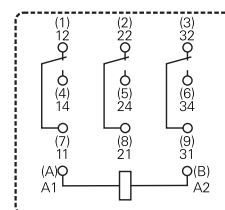

S0269-AB

2 C/O contacts

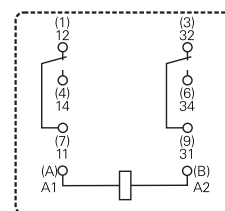

S0269-AD

Power Relay RM 2/3/7

2 / 3 pole 10 / 16 A, DC- or AC-coil

Dimensions

Dimensions in mm

Plain cover, plug-in version

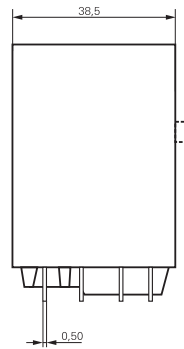
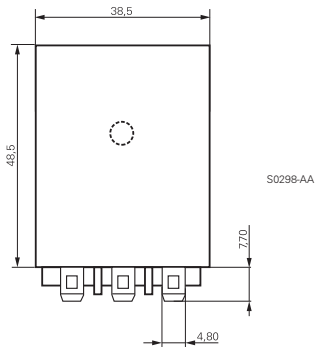

PCB version

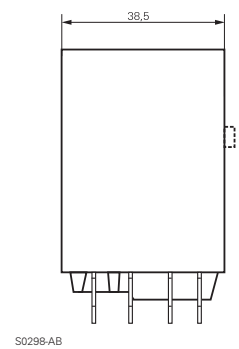
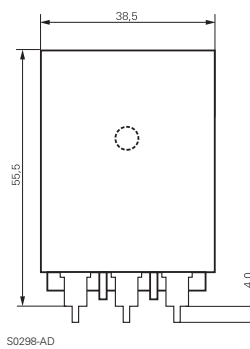

Cover with mounting brackets, FASTON 250 (187 available)

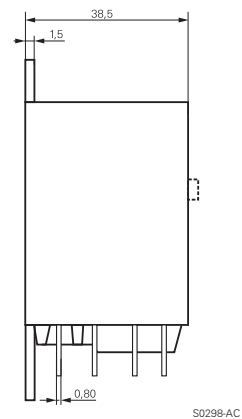
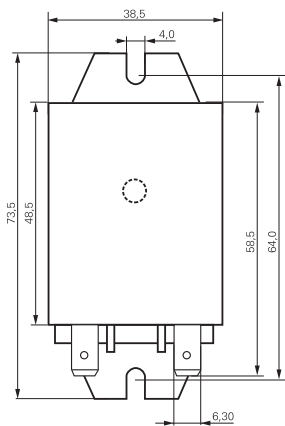

Cover with DIN-snap-on attachment (FASTON 250 only)
horizontal vertical

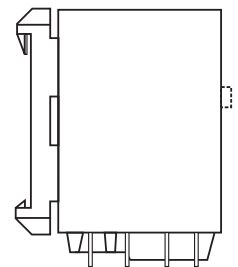
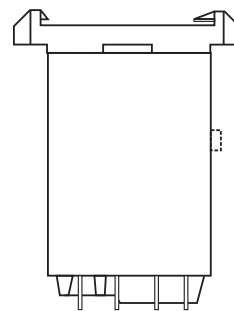

Product key

Type

Contacts

2 2 C/O contacts, 16 A

3 3 C/O contacts, 10 A

7 3 C/O contacts, 16 A

Version

0 without test button

3 with test button

Enclosure

2 plain cover, AMP-Faston 187

3 cover with mounting brackets, AMP-Faston 187

5 cover with mounting brackets, AMP-Faston 250

7 PCB version

8 cover with DIN-snap-on attachment, horizontal, AMP-Faston 250

9 cover with DIN-snap-on attachment, vertical, AMP-Faston 250

Coil

Coil code: please refer to coil versions table, preferred types in bold print

AMP-Faston 187 = 4.8 x 0.5 mm

AMP-Faston 250 = 6.3 x 0.8 mm

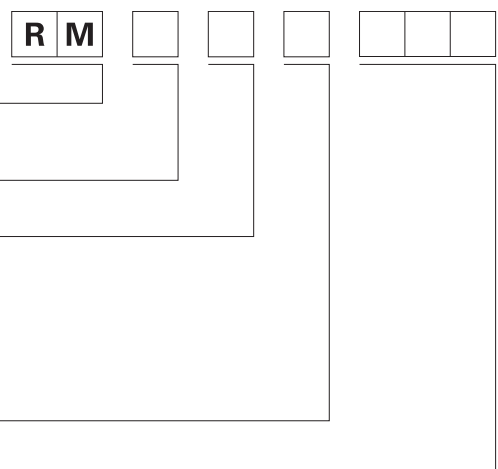

Power Relay RM 2/3/7

2 / 3 pole 10 / 16 A, DC- or AC-coil

Product key	Contacts	Version	Enclosure	Coil	Coil	Part number
RM202024	2 C/O contacts 16 A	without test button	plain cover AMP 187	DC-coil	24 Vdc	8-1393149-2
RM202524				AC-coil	24 Vac	1-1393146-9
RM202615					115 Vac	2-1393146-0
RM202730					230 Vac	1-1393148-4
RM203024			mounting brackets AMP 187	DC-coil	24 Vdc	1-1393148-6
RM203524				AC-coil	24 Vac	2-1393146-5
RM203615					115 Vac	2-1393146-6
RM203730					230 Vac	2-1393146-8
RM205024			mounting brackets AMP 250	DC-coil	24 Vdc	2-1393146-9
RM205524				AC-coil	24 Vac	3-1393146-0
RM205615					115 Vac	3-1393146-1
RM205730					230 Vac	3-1393146-2
RM207024			PCB version	DC-coil	24 Vdc	3-1393146-3
RM207615				AC-coil	115 Vac	8-1393149-5
RM207730					230 Vac	3-1393146-4
RM208024			DIN-snap-on horizontal	DC-coil	24 Vdc	3-1393146-5
RM208730				AC-coil	230 Vac	8-1393149-6
RM209730			DIN vertical		230 Vac	3-1393146-6
RM232024	with test button		plain cover AMP 187	DC-coil	24 Vdc	3-1393146-8
RM232524				AC-coil	24 Vac	3-1393146-9
RM232615					115 Vac	4-1393146-0
RM232730					230 Vac	3-1393107-4
RM233024			mounting brackets AMP 187	DC-coil	24 Vdc	3-1393107-5
RM233615				AC-coil	115 Vac	4-1393146-2
RM235024			mounting brackets AMP 250	DC-coil	24 Vdc	8-1393149-8
RM235730				AC-coil	230 Vac	4-1393146-5
RM239730			DIN vertical		230 Vac	4-1393148-7
RM302024	3 C/O contacts 10 A	without test button	plain cover AMP 187	DC-coil	24 Vdc	8-1393149-9
RM302524				AC-coil	24 Vac	5-1393146-3
RM302615					115 Vac	5-1393146-4
RM302730					230 Vac	5-1419150-3
RM303024				DC-coil	24 Vdc	6-1393148-4
RM303615				AC-coil	115 Vac	5-1393146-5
RM303730					230 Vac	5-1393146-7
RM307024			PCB version	DC-coil	24 Vdc	7-1393148-2
RM307730				AC-coil	230 Vac	5-1393146-9
RM332024	with test button		mounting brackets AMP 187	DC-coil	24 Vdc	9-1393149-2
RM332524				AC-coil	24 Vac	9-1393149-3
RM332730					230 Vac	9-1393149-4
RM333024				DC-coil	24 Vdc	9-1393149-6
RM335730			mount. Br AMP250	AC-coil	230 Vac	6-1393107-1
RM338730			DIN horizontal		230 Vac	7-1393148-7
RM339730			DIN vertical		230 Vac	6-1393107-2
RM702024	3 C/O contacts 16 A	without test button	plain cover AMP 187	DC-coil	24 Vdc	8-1393146-5
RM702524				AC-coil	24 Vac	0-1393844-9
RM702615					115 Vac	1-1393844-0
RM702730					230 Vac	1-1393844-1
RM703024				DC-coil	24 Vdc	1-1393844-2
RM703524				AC-coil	24 Vac	9-1393146-1
RM703615					115 Vac	9-1393146-2
RM703730					230 Vac	9-1393146-4
RM705024			mounting brackets AMP 250	DC-coil	24 Vdc	9-1393146-6
RM705524				AC-coil	24 Vac	9-1393146-7
RM705615					115 Vac	1-1393844-4
RM705730					230 Vac	1-1393844-5
RM707024			PCB version	DC-coil	24 Vdc	9-1393146-8
RM707524				AC-coil	24 Vac	0-1393147-1
RM707730					230 Vac	0-1393147-2
RM708024			DIN-snap-on AMP 250	DC-coil	24 Vdc	0-1393147-4
RM708730				AC-coil	230 Vac	1-1419136-0
RM709024				DC-coil	24 Vdc	2-1393149-2
RM709730				AC-coil	230 Vac	0-1393147-5
RM732024	with test button		mounting brackets AMP 187	DC-coil	24 Vdc	1-1393844-7
RM732524				AC-coil	24 Vac	1-1393147-0
RM732615					115 Vac	1-1393147-1
RM732730					230 Vac	1-1393844-8
RM733730					230 Vac	1-1393147-5
RM735024			mounting brackets AMP 250	DC-coil	24 Vdc	3-1393149-6
RM735524				AC-coil	24 Vac	3-1393149-7
RM735730					230 Vac	4-1393149-1
RM737730			PCB version		230 Vac	2-1393147-0
RM738024			DIN-snap-on	DC-coil	24 Vdc	2-1393844-0
RM738730			horizontal	AC-coil	230 Vac	2-1393147-2
RM739024			DIN-snap-on	DC-coil	24 Vdc	4-1393149-5
RM739730			vertical	AC-coil	230 Vac	2-1393844-2

Power Relay RM 5/6

2 / 3 pole 10 / 16 A, DC- or AC-coil



Features

- 2 N/O or 3 N/O contacts
- 3 mm contact gap
- Push-to-test-button
- Plug-in version, PCB terminals, chassis- or DIN-rail mount

Applications

Power supplies, pump control

F0164-A



Technical data of approved types on request

Contact data	RM 5	RM 6
Configuration	2 N/O contact	3 N/O contact
Type of contact	single contact	
Rated current	16 A	10 A
Rated voltage / max.breaking voltage AC	380 Vac / 440 Vac	
Maximum breaking capacity AC	6000 VA	3800 VA
Make current (max. 4 s at duty cycle 10%)	25 A	25 A
Contact material	AgCdO	

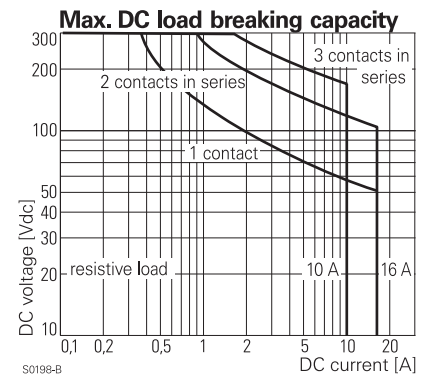

Coil data		
Nominal voltage	DC coil	6...220 Vdc
	AC coil	6...400 Vac
Nominal coil power	DC coil	1.6 W
	AC coil	2.8 VA

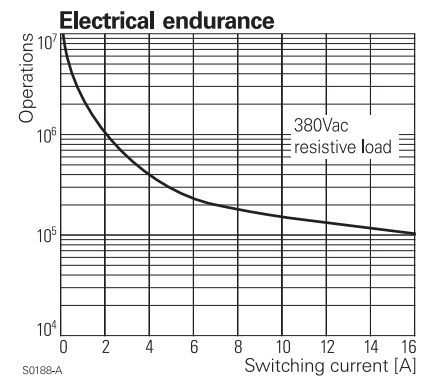

Coil versions, DC-coil, RM5, RM6

Coil code	Nominal voltage	Pull-in voltage	Release voltage	Coil resistance	Coil current			
STD	LED	PD*	LED	Vdc	Vdc	Vdc	Ω	mA
bipolar	PD*							
006	L06	0A6	LA6	6	4.5	0.6	24 ± 10%	250.0
012	L12	0B2	LB2	12	9.0	1.2	86 ± 10%	139.5
024	L24	0C4	LC4	24	18.0	2.4	345 ± 10%	69.6
048	L48	0E8	LE8	48	36.0	4.8	1340 ± 10%	35.8
060	L60	0G0	LG0	60	45.0	6.0	2200 ± 10%	27.3
110	M10	1B0	MB0	110	82.5	11.0	7300 ± 10%	15.1
221	N21	2C1	NC1	220	165.0	22.0	30000 ± 15%	7.3

All figures are given for coil without preenergization, at ambient temperature +20°C

* Protection diode PD; standard polarity: +A1 / -A2

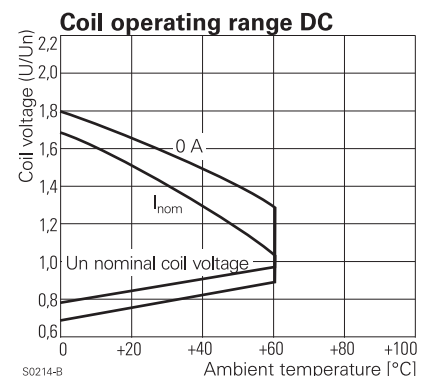

Power Relay RM 5/6

2 / 3 pole 10 / 16 A, DC- or AC-coil

Coil versions, AC-coil, RM5, RM6

Coil code	LED	Nominal voltage Vac	Pull-in voltage Vac	Release voltage Vac	Coil resistance Ω	Coil current mA
506	R06	6	4.8	2.4	$4.7 \pm 10\%$	476.7
512	R12	12	9.6	4.8	$19.5 \pm 10\%$	225.8
524	R24	24	19.2	9.6	$80 \pm 10\%$	109.2
548	R48	48	38.4	19.2	$320 \pm 10\%$	54.2
560	R60	60	48.0	24.0	$500 \pm 10\%$	43.7
615	S15	115	92.0	46.0	$1850 \pm 10\%$	23.0
730	T30	230	184.0	92.0	$7500 \pm 10\%$	11.7
900	V00	400	320.0	160.0	$23500 \pm 15\%$	6.5

All figures are given for coil without preenergization, at ambient temperature +20°C

Coil operating range AC

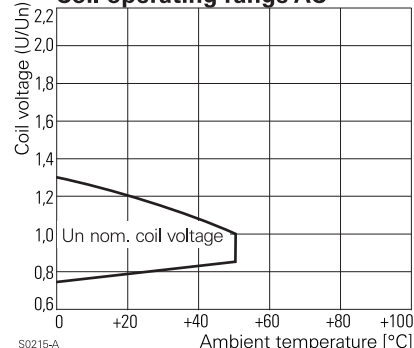

S0215-A

Insulation

Dielectric strength	coil-contacts	2500 V_{rms}
	open contact circuit	2500 V_{rms}
	adjacent contacts	2500 V_{rms}
Clearance / creepage		$\geq 3.5 / 6$ mm
Insulation to VDE 0110b (2/79)		
Insulation category / reference voltage		C / 400 with fully isolated Faston connectors

Other data

Ambient temperature	DC-coil	-45...+60 °C
	AC-coil	-45...+50 °C
Mechanical life	>20x10 ⁶ operations	
Max. switching rate at rated- / minimum load	16 min ⁻¹ / 100 min ⁻¹	
Operate- / release time	approx. 15 / 10 ms	
Bounce time	approx. 4 ms	
Vibration resistance	>12 g, 30...150 Hz	
Category of protection (IEC 61810)	RT I - dust protected	
Relay weight	81 g	
Packaging unit	10 / 25 pcs.	
Accessories	see accessories RM	

PCB layout / terminal assignment

View on solder pins
Dimensions in mm

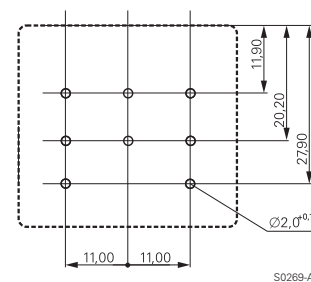

S0269-AF

3 N/O contacts

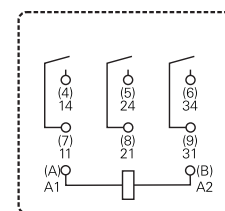

S0269-AC

2 N/O contacts

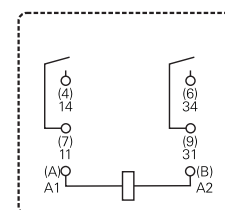

S0269-AE

Power Relay RM 5/6

2 / 3 pole 10 / 16 A, DC- or AC-coil

Dimensions

Dimensions in mm

Plain cover, plug-in version

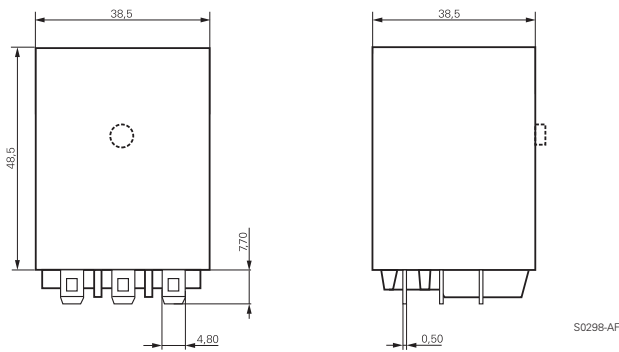

PCB version

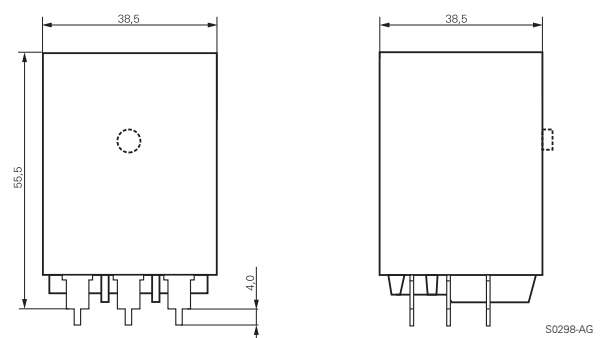

Cover with mounting brackets, FASTON 250 (187 available)

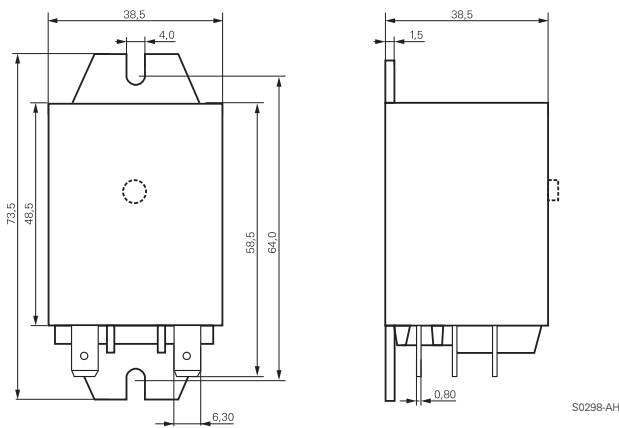

Cover with DIN-snap-on attachment (FASTON 250 only)

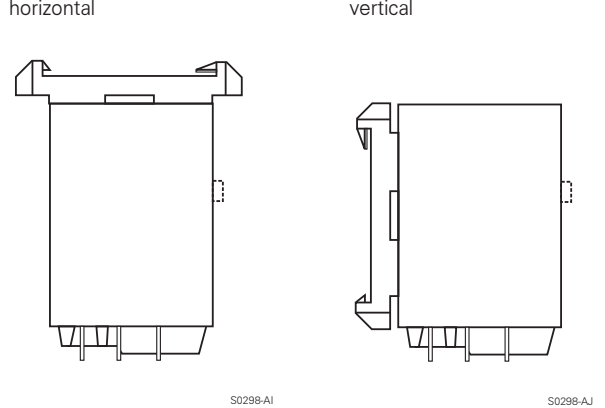

Product key

Type	R	M					
Contacts	5 2 N/O contacts, 16 A		6 3 N/O contacts, 10 A				
Version	0 without test button, without mechanical indicator						
	3 with test button, without mechanical indicator						
Mounting	2 plain cover, AMP-Faston 187						
	3 cover with mounting brackets, AMP-Faston 187						
	5 cover with mounting brackets, AMP-Faston 250						
	7 PCB version						
	8 cover with DIN-snap-on attachment, horizontal, AMP-Faston 250						
	9 cover with DIN-snap-on attachment, vertical, AMP-Faston 250						
Coil	Coil code: please refer to coil versions table, preferred types in bold print						
	AMP-Faston 187 = 4.8 x 0.5 mm AMP-Faston 250 = 6.3 x 0.8 mm						

Power Relay RM 5/6

2 / 3 pole 10 / 16 A, DC- or AC-coil

Product key	Contacts	Version	Enclosure	Coil	Coil	Part number	
RM502024	2 N/O contacts 16 A	without	plain cover	DC-coil	24 Vdc	6-1393146-1	
RM502524		test button	AMP 187	AC-coil	24 Vac	6-1393146-2	
RM502615		without			115 Vac	6-1393146-3	
RM502730		mech.indicator			230 Vac	6-1393146-4	
RM503024				mounting brackets	DC-coil	24 Vdc	8-1393148-0
RM503615				AMP 187	AC-coil	115 Vac	6-1393146-5
RM505024				mounting brackets	DC-coil	24 Vdc	8-1393148-3
RM505615				AMP 250	AC-coil	115 Vac	6-1393146-6
RM505730						230 Vac	9-1393149-9
RM507024				PCB version	DC-coil	24 Vdc	0-1393844-1
RM507524				AC-coil	24 Vac	5-1415008-1	
RM507615					115 Vac	6-1415015-1	
RM507730					230 Vac	0-1415008-1	
RM535024		test button	mounting brackets	DC-coil	24 Vdc	7-1393146-2	
RM535524		mech.indicator	AMP 250	AC-coil	24 Vac	9-1393148-0	
RM602024	3 N/O contacts 10 A	without	plain cover	DC-coil	24 Vdc	0-1393844-4	
RM602615		test button	AMP 187	AC-coil	115 Vac	9-1393148-7	
RM605730		without	mount.br.AMP250			230 Vac	7-1393146-6
RM607024		mechanical ind.	PCB version	DC-coil	24 Vdc	0-1393844-6	
RM607524					AC-coil	24 Vac	7-1393146-8
RM607615						115 Vac	8-1415015-1
RM607730						230 Vac	7-1393146-9
RM632024			with	plain cover	DC-coil	24 Vdc	8-1393146-0
RM632730			test button	AMP 187	AC-coil	230 Vac	0-1393149-7
RM635024			with	mount.br.AMP250	DC-coil	24 Vdc	7-1393107-7
RM637024		mech.indicator	PCB version		24 Vdc	0-1393149-9	

Power Relay RM 8

2 pole 25 A, DC- or AC-coil



Features

- 2 C/O contacts
- DC- or AC-coil
- Mechanical indicator
- Push-to-test-button
- Chassis- or DIN-rail mount

Applications

Cleaning equipment, heating and cooling equipment

F0165-A



Technical data of approved types on request

Contact data

Configuration	2 C/O contact
Type of contact	single contact
Rated current	25 A
Rated voltage / max.breaking voltage AC	250 Vac / 440 Vac
Maximum breaking capacity AC	6000 VA
Make current (max. 4 s at duty cycle 10%)	60 A
Contact material	AgCdO

Contact ratings

Type	Load	Standard
RM8	2hp, 240 Vac, per contact	UL 508
RM8	1.5hp, 120 Vac, per contact	UL 508
RM8	25 A, 240 Vac, per contact	UL 508

Coil data

Nominal voltage	DC coil	6...220 Vdc
	AC coil	6...400 Vac
Nominal coil power	DC coil	1.2 W
	AC coil	2.8 VA

Coil versions, DC-coil, RM8

Coil code	LED	PD*	LED	Nominal voltage	Pull-in voltage	Release voltage	Coil resistance	Coil current
STD	bipolar		PD*	Vdc	Vdc	Vdc	Ω	mA
006	L06	OA6	LA6	6	4.5	0.6	32±10%	187.5
012	L12	OB2	LB2	12	9.0	1.2	110±10%	109.1
024	L24	OC4	LC4	24	18.0	2.4	475±10%	50.5
048	L48	OE8	LE8	48	36.0	4.8	2000±10%	24.0
060	L60	OG0	LG0	60	45.0	6.0	2850±10%	21.1
110	M10	1B0	MB0	110	82.5	11.0	10000±12%	11.0
221	N21	2C1	NC1	220	165.0	22.0	40000±15%	5.5

All figures are given for coil without preenergization, at ambient temperature +20°C

* Protection diode PD; standard polarity: +A1 / -A2

Max. DC load breaking capacity

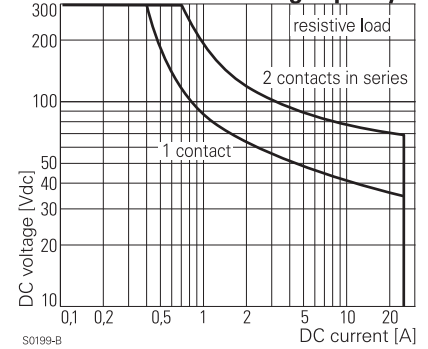

S0199-B

Electrical endurance

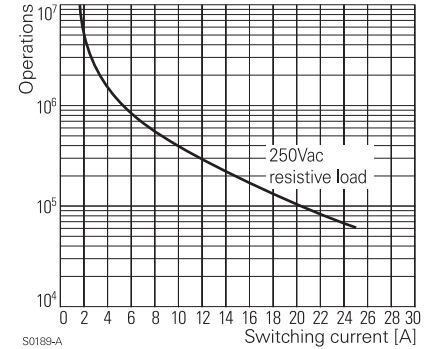

S0189-A

Coil operating range DC

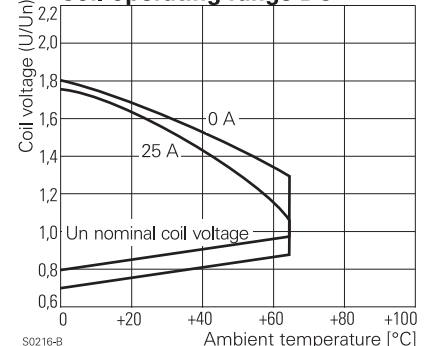

S0216-B

Power Relay RM 8

2 pole 25 A, DC- or AC-coil

Coil versions, AC-coil, RM8

Coil code	LED	Nominal voltage Vac	Pull-in voltage Vac	Release voltage Vac	Coil resistance Ω	Coil current mA
506	R06	6	4.8	2.4	$4.7 \pm 10\%$	476.7
512	R12	12	9.6	4.8	$19.5 \pm 10\%$	225.8
524	R24	24	19.2	9.6	$80 \pm 10\%$	109.2
548	R48	48	38.4	19.2	$320 \pm 10\%$	54.2
560	R60	60	48.0	24.0	$500 \pm 10\%$	43.7
615	S15	115	92.0	46.0	$1850 \pm 10\%$	23.0
730	T30	230	184.0	92.0	$7500 \pm 10\%$	11.7
900	V00	400	320.0	160.0	$23500 \pm 15\%$	6.5

All figures are given for coil without preenergization, at ambient temperature +20°C

Insulation

Dielectric strength	coil-contacts	2500 V_{rms}
	open contact circuit	1500 V_{rms}
	adjacent contacts	4000 V_{rms}
Clearance / creepage		$\geq 2.8 / 4 \text{ mm}$
Insulation to VDE 0110b (2/79)		
Insulation category / reference voltage		C / 250

Terminal assignment

View on solder pins
Dimensions in mm

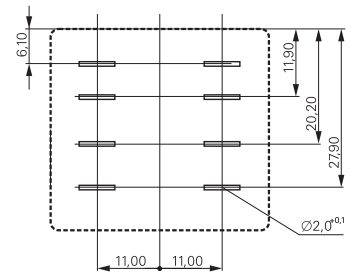

S0269-AG

Other data

Ambient temperature	DC-coil	-45...+65 °C
	AC-coil	-45...+40 °C
Mechanical life		$> 10 \times 10^6$ operations
Max. switching rate at rated- / minimum load		16 min^{-1} / 100 min^{-1}
Operate- / release time		approx. 15 / 15 ms
Bounce time		approx. 3 ms
Vibration resistance N/O / N/C contact		$> 10 / 5 \text{ g}$, 30...150 Hz
Category of protection (IEC 61810)		RT I - dust protected
Relay weight		81 g
Packaging unit		10 / 25 pcs.

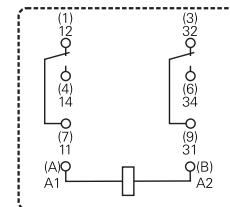

S0269-AD

Power Relay RM 8

2 pole 25 A, DC- or AC-coil

Dimensions

Dimensions in mm

Cover with mounting brackets, FASTON 250

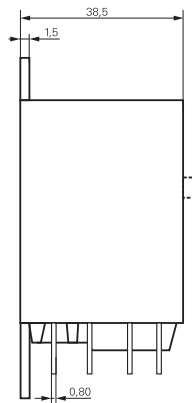
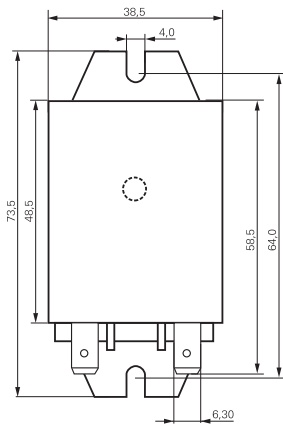

S0298-AC

Cover with DIN-snap-on attachment
horizontal

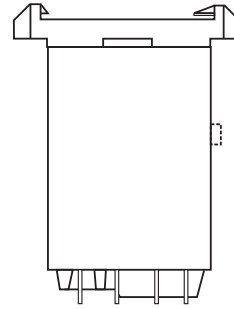

S0298-AD

vertical

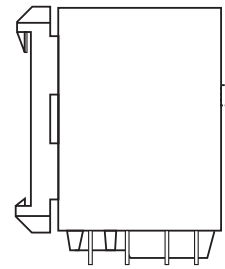

S0298-AE

Product key



Type

Contacts

8 2 C/O contacts, 25 A

Version

0 without test button **3** with test button

Mounting

5 cover with mounting brackets, AMP-Faston 250
8 cover with DIN-snap-on attachment, horizontal, AMP-Faston 250
9 cover with DIN-snap-on attachment, vertical, AMP-Faston 250

Coil

Coil code: please refer to coil versions table, preferred types in bold print

AMP-Faston 250 = 6.3 x 0.8 mm

Product key	Contacts	Version	Enclosure	Coil	Coil	Part number
RM805024	2 C/O contacts 25 A	without test button	mounting brackets AMP 250	DC-coil	24 Vdc	2-1393844-7
RM805524				AC-coil	24 Vac	2-1393147-9
RM805615					115 Vac	3-1393147-1
RM805730					230 Vac	3-1393147-3
RM808024			DIN-snap-on horizontal	DC-coil	24 Vdc	2-1393844-9
RM808524				AC-coil	24 Vac	3-1393147-7
RM808730					230 Vac	5-1393149-7
RM809024			DIN-snap-on vertical	DC-coil	24 Vdc	5-1393149-8
RM809615				AC-coil	115 Vac	3-1393147-8
RM809730					230 Vac	3-1393147-9
RM835024		with test button	mounting brackets AMP 250	DC-coil	24 Vdc	4-1393147-1
RM835524				AC-coil	24 Vac	4-1393147-3
RM835615					115 Vac	4-1393147-4
RM835730					230 Vac	4-1393147-6
RM838024			DIN-snap-on horizontal	DC-coil	24 Vdc	4-1393147-8
RM838524				AC-coil	24 Vac	5-1393147-0
RM838730					230 Vac	5-1393147-1
RM839024			DIN-snap-on vertical	DC-coil	24 Vdc	5-1393147-4
RM839524				AC-coil	24 Vac	5-1393147-5
RM839730					230 Vac	5-1393147-6

Power Relay RM C/D

1 pole 30 A, DC- or AC-coil



F0166-A

Features

- 1 N/O or 1 N/O + 1 N/C contact
- Switching capacity up to 7200 VA
- DC- or AC-coil
- Push-to-test-button
- Chassis mount

Applications

Battery chargers, heating control

Contact data	RMC	RMD
Configuration	1 N/O and 1N/C	1 N/O
Type of contact	single contact, bridging contact	
Rated current	30 A	
Rated voltage / max.breaking voltage AC	250 Vac / 380 Vac / 440 Vac	
Maximum breaking capacity AC	7500 VA	
Make current (max. 4 s at duty cycle 10%)	60 A	
Contact material	AgCdO	

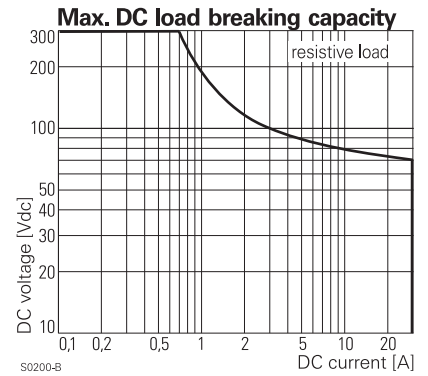

Coil data		
Nominal voltage	DC coil	6...220 Vdc
	AC coil	6...400 Vac
Nominal coil power	DC coil	1.2 W
	AC coil	2.8 VA

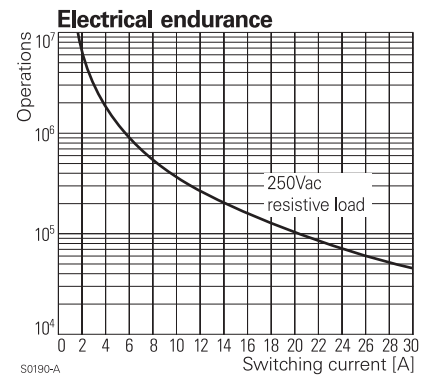

Coil versions, DC-coil, RMC, RMD

Coil code	Nominal voltage	Pull-in voltage	Release voltage	Coil resistance	Coil current
STD	Vdc	Vdc	Vdc	Ω	mA
LED bipolar	Vdc	Vdc	Vdc	Ω	mA
006	6	4.5	0.6	$32 \pm 10\%$	187.5
012	12	9.0	1.2	$110 \pm 10\%$	109.1
024	24	18.0	2.4	$475 \pm 10\%$	50.5
048	48	36.0	4.8	$2000 \pm 10\%$	24.0
060	60	45.0	6.0	$2850 \pm 10\%$	21.1
110	110	82.5	11.0	$10000 \pm 12\%$	11.0
221	220	165.0	22.0	$40000 \pm 15\%$	5.5

All figures are given for coil without preenergization, at ambient temperature +20°C

* Protection diode PD; standard polarity: +A1 / -A2

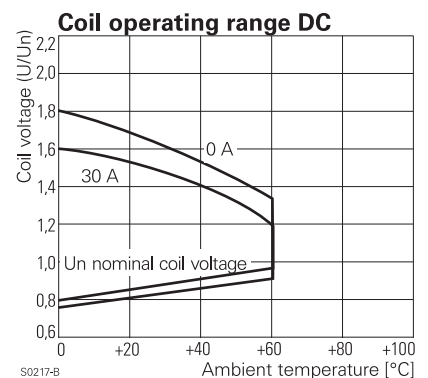

Power Relay RM C/D

1 pole 30 A, DC- or AC-coil

Coil versions, AC-coil, RMC, RMD

Coil code	LED	Nominal voltage Vac	Pull-in voltage Vac	Release voltage Vac	Coil resistance Ω	Coil current mA
524	R24	24	19.2	9.6	80±10%	109.2
548	R48	48	38.4	19.2	320±10%	54.2
560	R60	60	48.0	24.0	500±10%	43.7
615	S15	115	92.0	46.0	1850±10%	23.0
730	T30	230	184.0	92.0	7500±10%	11.7
900	V00	400	320.0	160.0	23500±15%	6.5

All figures are given for coil without preenergization, at ambient temperature +20°C

Insulation

Dielectric strength	coil-contacts	2500 V_{rms}
	open contact circuit	1500 V_{rms}
	adjacent contacts	4000 V_{rms}
Clearance / creepage		$\geq 2.8 / 4$ mm
Insulation to VDE 0110b (2/79)		
Insulation category / reference voltage		C / 250

Other data

Ambient temperature	DC-coil	-45...+60 °C
	AC-coil	-45...+40 °C
Mechanical life		>10x10 ⁶ operations
Max. switching rate at rated- / minimum load		16 min ⁻¹ / 100 min ⁻¹
Operate- / release time		approx. 17 / 18 ms
Bounce time		approx. 4 ms
Vibration resistance N/O / N/C contact		>10 / 5 g, 30...150 Hz
Category of protection (IEC 61810)		RT I - dust protected
Relay weight		81 g
Packaging unit		10 pcs.

Terminal assignment

View on solder pins
Dimensions in mm

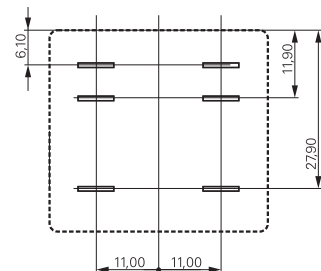

S0269-AK

1 N/O and 1 N/C contact, RMC

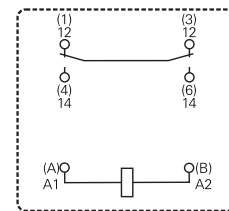

S0269-AH

1 N/O contact, RMD

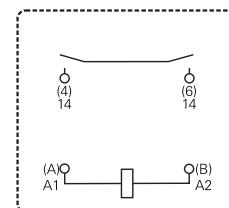

S0269-AI

Power Relay RM C/D

1 pole 30 A, DC- or AC-coil

Dimensions

Dimensions in mm

Cover with mounting brackets, FASTON 250

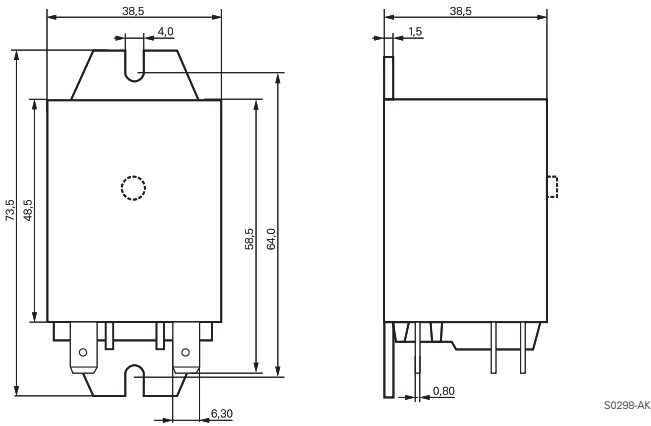

Product key



Type

Contacts

- C** 1 N/O contact and 1 N/C contact, 30 A
- D** 1 N/O contact, 30 A

Version

- 0** without test button
- 3** with test button

Mounting

- 5** cover with mounting brackets, AMP-Faston 250

Coil

Coil code: please refer to coil versions table, preferred types in bold print

AMP-Faston 250 = 6.3 x 0.8 mm

Product key	Contacts	Version	Enclosure	Coil	Coil	Part number
RMC05024	1 N/O + 11 N/C contact 30 A	without test button	mounting brackets AMP 250	DC-coil	24 Vdc	4-1393844-5
RMC05524		with test button		AC-coil	24 Vac	0-1393146-5
RMC05615					115 Vac	8-1393147-7
RMC05730					230 Vac	0-1393146-6
RMC35024		with test button		DC-coil	24 Vdc	0-1393146-7
RMD05024	1 N/O contact 30 A	without test button			24 Vdc	0-1393146-9
RMD05524		with test button		AC-coil	24 Vac	1-1393146-1
RMD05615					115 Vac	0-1415009-1
RMD05730					230 Vac	4-1393844-7
RMD35024		with test button		DC-coil	24 Vdc	2-1419136-2
RMD35730		with test button		AC-coil	230 Vac	0-1393097-5

Sockets and Accessories

Sockets and accessories for DIN rail

relay	socket		plastic retaining clip				metal retaining clip		module	marking tag
SNR	ST1F000	ST16016								ST16040
	rel.height	12.3mm	15.7mm	25.5mm						
RY pinning 3.2	RY78626	RY16046							RPMxxxxx	RY16040
RY pinning 5.0										
E pinning 2.5	RP78623			RP16104					RPMxxxxx	RY16040
RT pinning 3.5	RT78724		RT17016						PTMxxxxx	RT17040
	RT78624		RT16016						RPMxxxxx	RY16040
RT pinning 5.0	RT78726		RT17016						PTMxxxxx	RT17040
	RT78625		RT16016						RPMxxxxx	RY16040
	RT78626		RT16016						RPMxxxxx	RY16040
RP pinning 3.5	RT78724			RT17016					PTMxxxxx	RT17040
	RT78624			RP16104					RPMxxxxx	RY16040
RP pinning 5.0	RT78726			RT17016					PTMxxxxx	RT17040
	RT78625			RP16104					RPMxxxxx	RY16040
	RT78626			RP16104					RPMxxxxx	RY16040
	rel.height	29mm	34.6mm	35.2mm	36.6mm	37.6mm	29mm	36mm		
PT2	PT78720	PT17016	PT17017	PT17018	PT17019	PT17020	PT28800	ZG28801	PTMxxxxx	PT17040
	PT78702	PT16016					PT28800	ZG28801	RPMxxxxx	PT16040
	PT78741	PT17016	PT17017	PT17018	PT17019	PT17020	PT28800	ZG28801	PTMT00A0	PT17040
PT3	PT78730	PT17016	PT17017	PT17018	PT17019	PT17020	PT28800	ZG28801	PTMxxxxx	PT17040
	PT78703	PT16016					PT28800	ZG28801	RPMxxxxx	PT16040
PT5	PT78740	PT17016	PT17017	PT17018	PT17019	PT17020	PT28800	ZG28801	PTMxxxxx	PT17040
	PT78741	PT17016	PT17017	PT17018	PT17019	PT17020	PT28800	ZG28801	PTMT00A0	PT17040
	PT78704	PT16016					PT28800	ZG28801	RPMxxxxx	PT16040
MT2	MT78755						MT28800			
	MT78745						MT28800		MTMxxxxx	
MT3	MT78750						MT28800			
	MT78760						MT28800			
	MT78740						MT28800		MTMxxxxx	
PCLH	TM78700						TM28800			
RMxx2	RM78704									
	RM78705									

Sockets and Accessories for printed circuit board

relay	socket	plastic retaining clip			metal retaining clip		in mounting plate		marking tag
							socket	metal retaining clip	
	rel.height	12.3mm	15.7mm	25.5mm	15.7mm	25.5mm			
RY pinning 3.2	RY78600	RY16037							
RY pinning 5.0	RY78602	RY16037							
E pinning 2.5	RP78600			RP16100		RP28500			
RT pinning 3.5	RP78601		RT16041		RT28516				
RT pinning 5.0	RP78602		RT16041		RT28516				
RP pinning 3.5	RP78601			RP16100		RP28500			
RP pinning 5.0	RP78602			RP16100		RP28500			
	rel.height				29mm	36mm		29mm	36mm
PT2	PT78604				PT28802	ZG28800	PT78600	PT28802	ZG28800
	PT78602				PT28802	ZG28800	PT78601	PT28802	ZG28800
PT3	PT78603				PT28802	ZG28800			
PT5	PT78604				PT28802	ZG28800	PT78600	PT28802	ZG28800
							PT78601	PT28802	ZG28800
MT2	MT78602						MT78612		
MT3	MT78603						MT78613		
PCLH									
RMxx2	RM78702				RM28802		RM78700	RM28802	
							RM78701	RM28802	

All sockets in this catalog have been tested and approved with the Tyco Electronics Schrack product range. For combination of sockets with other relays with similar design and pinning we cannot take responsibility for any malfunction.

Accessories Slim Interface Relay SNR



F0222-B

Features

- Module width 5.08 mm
- Reduced system width for increased packing density on the DIN rail
- Jumper bars

Dimensions in mm



Technical data

Rated current / rated voltage	6 A / 250 Vac
Dielectric strength coil-contact	>4000 V _{rms}
Insulation category (VDE 0110b)	C / 250
Ambient temperature	-20...55 °C
Protection category	IP 20
Protection against accidental contact meets	VBG 4
Wire cross section with/without bootlace crimp	0.22...2.5mm ²
Terminal torque nom./max.	0.4 / 0.6 Nm
Packaging unit	10 pcs.

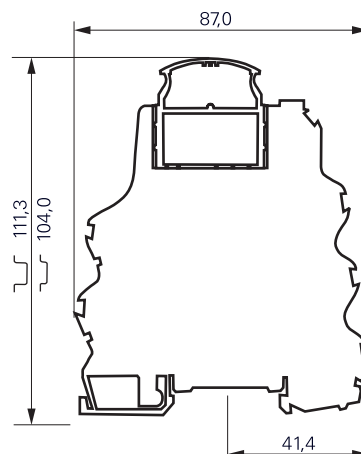

Accessories

Product code		Part Number
ST 1F 000	Socket without LED	4-1415024-1
ST 1F L24	Socket with LED, 12...24 Vdc	5-1415024-1
ST 16 016	Mounting frame for relay, without marking	6-1415024-1
ST 17 002	Jumper bar 2 pole	7-1415024-1
ST 17 005	Jumper bar 5 pole	8-1415024-1
ST 17 010	Jumper bar 10 pole	9-1415024-1
ST 16 040	Marking plate, consisting of 100 marking tags	0-1415025-1



Available sets

Set consisting of: relay in mounting frame, mounted on socket

Product code		Part Number
ST 1P3 024	24 Vdc, AgSnO ₂ contacts	3-1415024-1
ST 1P3 L12	12 Vdc, with LED, AgSnO ₂ contacts	2-1415025-1
ST 1P3 L24	24 Vdc, with LED, AgSnO ₂ contacts	3-1415025-1
ST 1P3 L48	48 Vdc, with LED, AgSnO ₂ contacts	4-1415025-1
ST 1P2 L24	24 Vdc, with LED, AgSnO ₂ gold plated contacts	6-1415025-1

Accessories Miniature PCB Relay RYII

and similar design: pinning 3.2 / 5 mm



Features

- Socket with PCB- or screw terminals
- No reduction of protection class or creepage/clearance with plastic retainer
- Easy replacement of relays
- Socket can be used as connector for diagnosis function
- Not suitable for MSR-type

Dimensions in mm
View on solder pins

RYII Socket with screw-type terminals for DIN-rail mounting

F0127-A

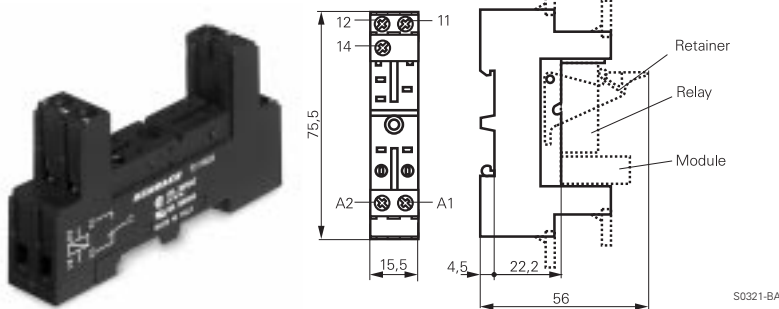

RY 78 626 Socket with screw-type terminals for DIN-rail mounting, pinning 3.2 mm



Technical data

Rated current	12 A
Rated voltage	300 Vac
Dielectric strength coil/cont.	>4000 V _{rms}
Insulation cat. (VDE 0110b)	C / 250 Vac
Ambient temperature	-25...+85 °C
Protection category	IP 20
Protection against accidental contact meets	VBG 4
Wire cross section with bootlace crimp	2 x 2.5 mm ² 2 x 1.5 mm ²
Packaging unit	10 pcs.

Socket with screw-type terminals for DIN-rail mounting

Type	Part Number
RY 78 626 Socket with screw-type terminals for DIN-rail mounting, pinning 3.2 mm	7-1393161-8

Accessories for RY 78 626

RY 16 046 Plastic retaining clip	7-1393161-1
RY 16 040 Marking tag	6-1393161-8
RPM Modules see accessories RT / RP	

RYII Socket with PCB terminals

RY 78 600 pinning 3.2 mm



F0125-A

RY 78 602 pinning 5 mm



F0126-A

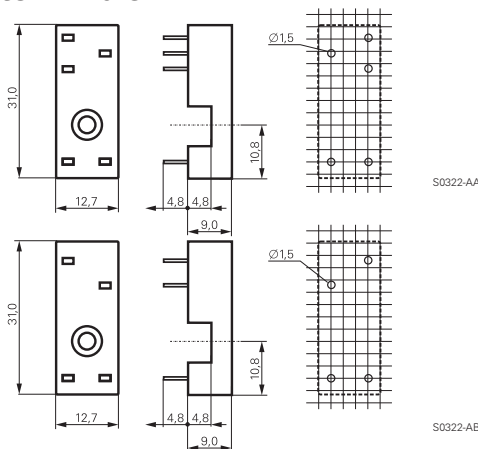

RY 78 600 Socket with PCB terminals, pinning 3.2 mm

RY 78 602 Socket with PCB terminals, pinning 5 mm



Technical data

Rated current	12 A
Rated voltage	300 Vac
Dielectric strength coil/cont.	>5000 V _{rms}
Insulation cat. (VDE 0110b)	C / 250 Vac
Ambient temperature	-40...+80 °C
Packaging unit	100 pcs.

Socket with PCB terminals

Type	Part Number
RY 78 600 Socket with PCB terminals, pinning 3.2 mm	7-1393161-3
RY 78 602 Socket with PCB terminals, pinning 5 mm	7-1393161-4

Accessories for RY 78 600, RY 78 602

RY 16 037 Plastic retaining clip	6-1393161-5
---	-------------

Accessories PCB Relay Card Relay E

and similar design: pinning 2.5 mm

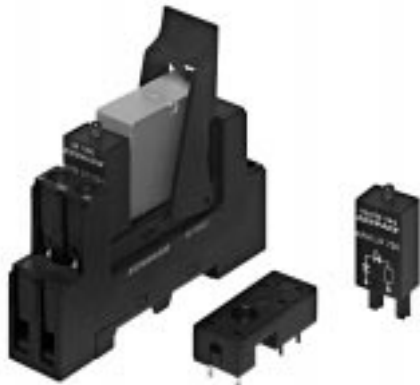

F0227-A

Features

- Socket with PCB- or screw terminals
- No reduction of protection class or creepage / clearance with plastic retainer
- Easy replacement of relays
- Socket can be used as connector for diagnosis function

Dimensions in mm
View on solder pins

Socket with screw-type terminals for DIN-rail mounting

F0118-A

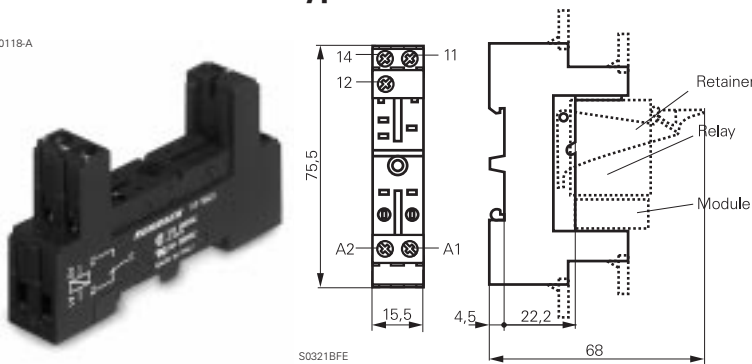

S0321BFE

RP 78 623 Socket with screw-type terminals, pinning 2.5 mm, for DIN-rail mounting



Technical data

Rated current	12 A
Rated voltage	300 Vac
Dielectric strength coil/cont.	>4000 V _{rms}
Insulation cat. (VDE 0110b)	C / 250 Vac
Ambient temperature	-25...+85 °C
Protection category	IP 20
Protection against accidental contact meets	VBG 4
Wire cross section	2 x 2.5 mm ²
with bootlace crimp	2 x 1.5 mm ²
Packaging unit	10 pcs.

Socket with screw-type terminals for DIN-rail mounting

Product code	Part Number
RP 78 623 Socket with screw-type terminals, pinning 2.5 mm for DIN-rail mounting	8-1393234-6

Accessories for RP 78 623

Ordering code	Type	Part Number
RP 16 104	Plastic retaining clip	1-1393161-8
RY 16 040	Marking tag	6-1393161-8
RP M	Modules see accessories RT / RP	

Socket with PCB terminals



F0137-A

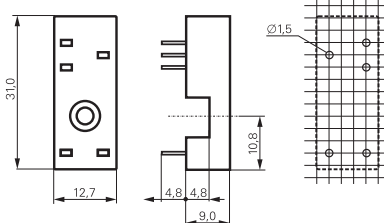

S0322-AE

RP 78 600 Socket with PCB terminals, pinning 2.5 mm



Technical data

Rated current	12 A
Rated voltage	300 Vac
Dielectric strength coil/cont.	>5000 V _{rms}
Insulation cat. (VDE 0110b)	C / 250 Vac
Ambient temperature	-40...+80 °C
Packaging unit	100 pcs.

Socket with PCB terminals

Product code	Part Number
RP 78 600 Socket with PCB terminals, pinning 2.5 mm	8-1393234-3

Accessories for RP 78 600

Product code	Type	Part Number
RP 16 100	Plastic retaining clip	1-1393161-7
RP 28 500	Metal retaining clip	1-1393161-9

Accessories Industrial Power Relay RT / RP / SR2M

and similar design: pinnings 3.5mm / 5mm; relay heights 15.7 / 25.5mm



F0228-A

Features

- New retainer clip with ejection function
- Easy replacement of relays on a densely packed DIN rail
- High quality rising clamp terminals
- Captive combination terminal screws
- No reduction of protection class or creepage/clearance with plastic retainer
- Simple plug-in indicator- and protection modules
- White snap-on tags
- Not suitable for bistable relays with 2 coils

Accessories for sockets:

- Rejector
- LED- and protection modules
- Marking tags

Dimensions in mm

Socket with screw-type terminals for DIN rail mounting



F0229-A

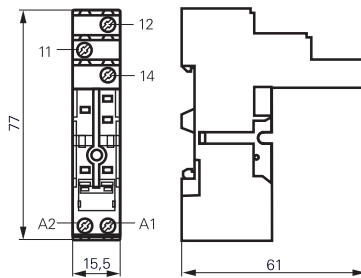

S0416-AA

RT 78 724 Socket with screw-type terminals, pinning 3.5 mm for DIN rail mounting



Technical data

Rated current	12 A
Rated voltage	250 Vac
Insulation cat. (VDE 0110b)	C / 250 Vac
Ambient temperature	-25...85 °C
Protection category	IP 20
Wire cross section	2 x 2.5 mm ²
with bootlace crimp	2 x 1.5 mm ²
Terminal torque	0.5 Nm
max.	0.7 Nm
Packaging unit	10 pcs.

RT 78 724 and RT 78 726

- Logical setup of connections (input / output)
- Safe separation to VDE 0106



F0230-A

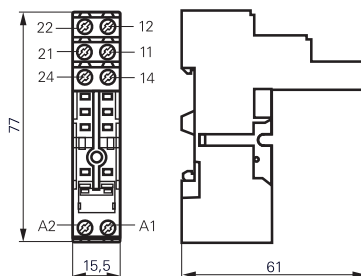

S0416-AB

RT 78 726 Socket with screw-type terminals, pinning 5 mm for DIN rail mounting



Technical data

Rated current	1 pole	12 A *)
	2 pole	2 x 12 A
Rated voltage	250 Vac	
Insulation cat. (VDE 0110b)	C / 250 Vac	
Ambient temperature	-25...85 °C	
Protection category	IP 20	
Wire cross section	2 x 2.5 mm ²	
with bootlace crimp	2 x 1.5 mm ²	
Terminal torque	0.5 Nm	
max.	0.7 Nm	
Packaging unit	10 pcs.	

*) For 1 pole relays (16 A) the relay terminals 11-21, 12-22 and 14-24 have to be bridged
For 1 pole relays (12 A) the relay terminals 11-12-14 have to be connected to the socket terminals 21-12-24

Socket with screw-type terminals for DIN rail mounting

Type		Part Number
RT 78 724	Socket with screw-type terminals, pinning 3.5 mm for DIN rail mounting	8-1415035-1
RT 78 726	Socket with screw-type terminals, pinning 5 mm for DIN rail mounting	6-1415035-1

Accessories Industrial Power Relay RT / RP / SR2M

and similar design: pinnings 3.5mm / 5mm; relay heights 15.7 / 25.5mm

Accessories for RT 78 724, RT 78 726

Type		Part Number
RT 17 016	Plastic retaining clip, relay height 15.7 and 25.5 mm	1-1415038-1
RT 17 040	Marking tag	2-1415038-1

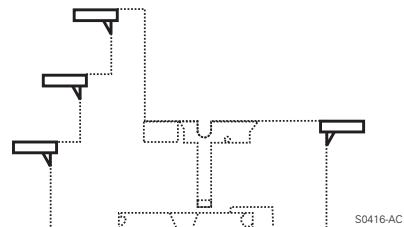

Marking tags

- White marking area 15.5 x 6 mm
- Snaps on socket in up to 4 positions

LED- and Protection Modules for RT 78 724, RT 78 726

Easy insertion of module into the socket

Wiring in parallel to the coil

Type		Part Number
PTM T0 0A0	Protection diode (A1+, A2-)	9-1415036-1
PTM T0 0L0	Protection diode (A1-, A2+)	0-1415037-1
PTM U0 524	RC-network 6...60 Vac	1-1415037-1
PTM U0 730	RC-network 110...230 Vac	2-1415037-1
PTM V0 524	Varistor 24 Vac	3-1415037-1
PTM V0 730	Varistor 230 Vac	4-1415037-1

LED

PTM L0 524	red LED 6...24 Vdc/Vac	6-1415036-1
PTM G0 524	green LED 6...24 Vdc/Vac	3-1415036-1
PTM L0 024	red LED 6...24 Vdc w. prot.diode (A1+, A2-)	5-1415036-1
PTM G0 024	green LED 6...24 Vdc w. prot.diode (A1+, A2-)	2-1415036-1
PTM L1 024	red LED 6...24 Vdc w. prot. diode (A1-, A2+)	8-1415036-1
PTM L0 730	red LED 110...230 Vac	7-1415036-1
PTM G0 730	green LED 110...230 Vac	4-1415036-1



F0231-A



F0232-A

Accessories Industrial Power Relay RT / RP / SR2M

and similar design: pinning 3.5mm / 5mm; relay heights 15.7 / 25.5mm

Dimensions in mm

RT 78 624 Socket with screw-type terminals, pinning 3.5 mm for DIN rail mounting

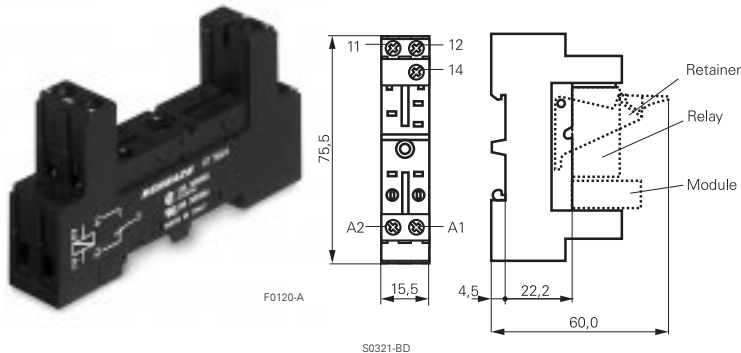

Technical data

Rated current	12 A
Rated voltage	300 Vac
Dielectric strength coil/cont.	>4000 V _{rms}
Insulation cat. (VDE 0110b)	C / 250 Vac
Ambient temperature	-25...+85 °C
Protection category	IP 20
Protection against accidental contact meets	VBG 4
Wire cross section	2 x 2.5 mm ²
with bootlace crimp	2 x 1.5 mm ²
Packaging unit	10 pcs.

RT 78 625 Socket with screw-type terminals, pinning 5 mm for DIN rail mounting

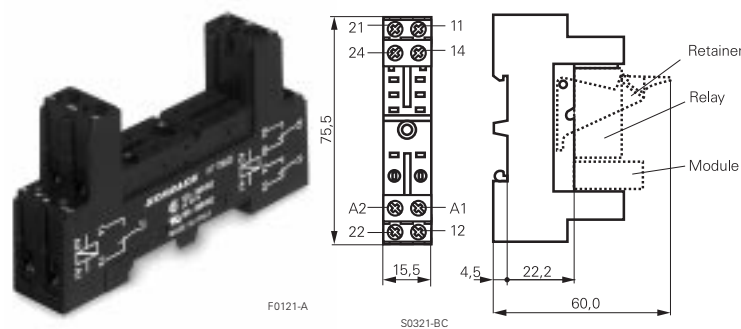

Technical data

Rated current	1 pole 12 A *)
	2 pole 2 x 12 A
Rated voltage	300 Vac
Dielectric strength coil/cont.	>4000 V _{rms}
Insulation cat. (VDE 0110b)	C / 250 Vac
Ambient temperature	-25...+80 °C
Protection category	IP 20
Protection against accidental contact meets	VBG 4
Wire cross section	2 x 2.5 mm ²
with bootlace crimp	2 x 1.5 mm ²
Packaging unit	10 pcs.

RT 78 624 and RT 78 626

- Logical setup of connections (input / output)
- Safe separation to VDE 0106

*) For 1 pole relays (16 A) the terminals 11-21, 12-22 and 14-24 have to be bridged
For 1 pole relays (12 A) the terminals 11-12-14 have to be connected to the socket terminals 21-12-24

RT 78 626 Socket with screw-type terminals, pinning 5 mm for DIN rail mounting

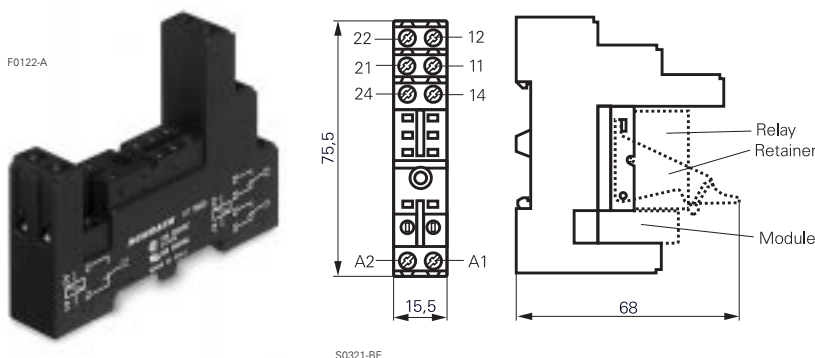

Technical data

Rated current	1 pole 12 A *)
	2 pole 2 x 12 A
Rated voltage	300 Vac
Dielectric strength coil/cont.	>4000 V _{rms}
Insulation cat. (VDE 0110b)	C / 250 Vac
Ambient temperature	-25...+80 °C
Protection category	IP 20
Protection against accidental contact meets	VBG 4
Wire cross section	2 x 2.5 mm ²
with bootlace crimp	2 x 1.5 mm ²
Packaging unit	10 pcs.

*) For 1 pole relays (16 A) the terminals 11-21, 12-22 and 14-24 have to be bridged
For 1 pole relays (12 A) the terminals 11-12-14 have to be connected to the socket terminals 21-12-24

Socket with screw-type terminals, for DIN rail mounting

Type		Part Number
RT 78 624	Socket with screw-type terminals, pinning 3.5 mm for DIN rail mounting	2-1419108-1
RT 78 625	Socket with screw-type terminals, pinning 5 mm for DIN rail mounting	2-1419108-2
RT 78 626	Socket with screw-type terminals, pinning 5 mm for DIN rail mounting	2-1419108-3

Accessories Industrial Power Relay RT / RP / SR2M

and similar design: pinnings 3.5mm / 5mm; relay heights 15.7 / 25.5mm

Dimensions in mm
View on solder pins

Accessories for RT 78 624, RT 78 625, RT 78 626

Type		Part Number
RT 16 016	Plastic retaining clip RT, relay height 15.7 mm	3-1393161-3
RP 16 104	Plastic retaining clip RP, relay height 25.5 mm	1-1393161-8
RY 16 040	Marking tag	6-1393161-8

LED- and Protection Modules for RT 78 624, RT 78 625, RT 78 626 and RP 78 623, RY 78 626

Easy insertion of module into the socket

Wiring in parallel to the coil

Type		Part Number
RPM T0 0A0	Protection diode 1N4007 ¹⁾	1-1393161-1
RPM U0 548	RC-network 24...48 Vac	1-1393161-3
RPM U0 730	RC-network 110...230 Vac	1-1393161-4

LED

RPM L0 024	red LED 12...24 Vdc w.prot.diode ¹⁾	0-1393161-4
RPM G0 024	green LED 12...24 Vdc w.prot.diode ¹⁾	0-1393161-3
RPM L0 524	red LED 12...48 Vdc / Vac	0-1393161-7
RPM G0 524	green LED 12...48 Vdc / Vac	2-1419152-4
RPM L0 110	red LED 60...110 Vdc w.prot.diode ¹⁾	0-1393161-6
RPM G0 110	green LED 60...110 Vdc w.prot.diode ¹⁾	2-1419152-3
RPM L0 730	red LED 110...230 Vac	0-1393161-8
RPM G0 730	green LED 110...230 Vac	2-1419152-5

¹⁾ Standard polarity: A1:+, A2:-

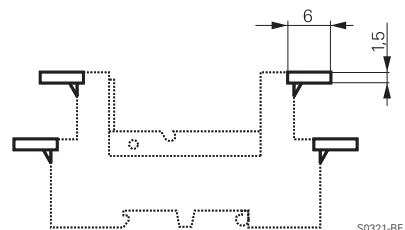

Marking tags

- White marking area 15.5 x 6 mm
- Snaps on socket in up to 4 positions

F0123-A



Socket with PCB terminals

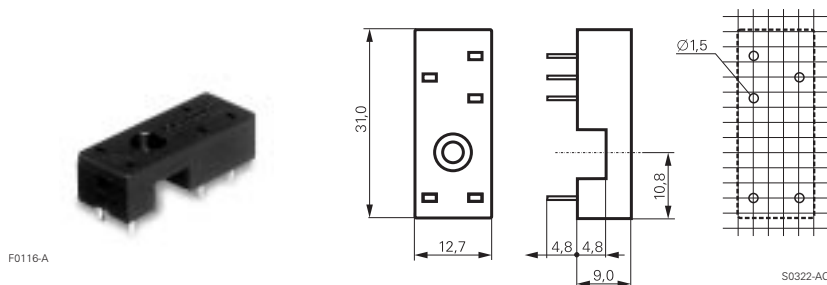

F0116-A

RP 78 601 Socket with PCB terminals, pinning 3.5 mm



Technical data

Rated current	12 A
Rated voltage	300 Vac
Dielectric strength coil/cont.	>5000 V _{rms}
Insulation cat. (VDE 0110b)	C / 250 Vac
Ambient temperature	-40...+80 °C
Packaging unit	100 pcs.

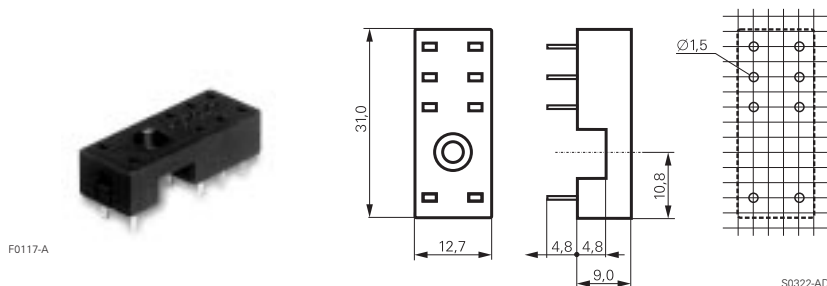

F0117-A

RP 78 602 Socket with PCB terminals, pinning 5 mm



Technical data

Rated current	1 pole	12 A
	2 pole	2 x 12 A
Rated voltage		300 Vac
Dielectric strength coil/cont.		>5000 V _{rms}
Insulation cat. (VDE 0110b)		C / 250 Vac
Ambient temperature		-40...+80 °C
Packaging unit		100 pcs.

Socket with PCB terminals

Type		Part Number
RP 78 601	Socket with PCB terminals, pinning 3.5 mm	8-1393234-4
RP 78 602	Socket with PCB terminals, pinning 5 mm	8-1393234-5

Accessories for RP 78 601, RP 78 602

Type		Part Number
RT 16 041	Plastic retaining clip RT, relay height 15.7 mm	3-1393161-4
RP 16 100	Plastic retaining clip RP, relay height 25.5 mm	1-1393161-7
RT 28 516	Metal retaining clip RT, relay height 15.7 mm	0-1419108-7
RP 28 500	Metal retaining clip RP, relay height 25.5 mm	1-1393161-9

Accessories Miniature Relay PT

and similar design: relay heights 29 / 34.6 / 35.2 / 36.6 / 37.6mm



F0233-A

Features

- Easy replacement of relays on a densely packed DIN rail
- High quality rising clamp terminals
- Captive combination terminal screws
- No reduction of protection class or creepage/clearance with plastic retainer
- Simple plug-in indicator- and protection modules
- White snap-on tags

Accessories for sockets:

- Retaining clip
- LED- and protection modules
- Marking tags

Dimensions in mm

PT DIN-rail socket with screw type terminals



F0234-A

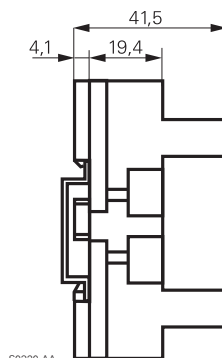
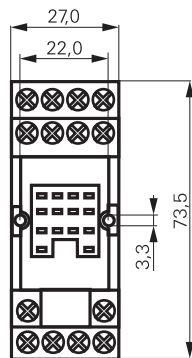

S0320-AA



Technical data

Rated current	4-pole	6 A
	3-pole	10 A
	2-pole	12 A
Rated voltage	250 Vac	
Insulation cat. (VDE 0110b)	C / 250 Vac	
Ambient temperature	-45...+70 °C	
Protection category	IP 20	
Protection against accidental contact meets	VBG 4	
Wire cross section	2 x 2.5 mm ²	
with bootlace crimp	2 x 1.5 mm ²	
Terminal torque	0.5 Nm	
max.	0.7 Nm	
Packaging unit	10 pcs.	

DIN-rail socket with screw type terminals

Type		Part Number
PT 78 720	DIN-rail socket with screw type terminals, 2 pole	6-1415034-1
PT 78 730	DIN-rail socket with screw type terminals, 3 pole	9-1415071-1
PT 78 740	DIN-rail socket with screw type terminals, 4 pole	4-1415033-1
PT 78 741	DIN-rail socket with screw type terminals, 4 pole package with protection diode module	5-1415034-1

Accessories for PT 78 720, PT 78 730, PT 78 740, PT 78 741

Type		Part Number
PT 17 016	Plastic retaining clip PT, relay height 29 mm	5-1415037-1
PT 17 017	Plastic retaining clip, relay height 34.6 mm	7-1415037-1
PT 17 018	Plastic retaining clip, relay height 35.2 mm	8-1415037-1
PT 17 019	Plastic retaining clip, relay height 36.6 mm	9-1415037-1
PT 17 020	Plastic retaining clip, relay height 37.6 mm	0-1415038-1
PT 28 800	Metal retaining clip PT, relay height 29 mm	5-1419111-9
ZG 28 801	Metal retaining clip, relay height 36 mm	1-1393162-5
PT 17 040	Marking tag	6-1415037-1

Accessories Miniature Relay PT

and similar design: relay heights 29 / 34.6 / 35.2 / 36.6 / 37.6mm

LED- and Protection Modules for PT 78 720, PT 78 730 and PT 78 740

Easy insertion of module into the socket

Wiring in parallel to the coil

Type		Part Number
PTM T0 0A0	Protection diode (A1+, A2-)	9-1415036-1
PTM T0 0L0	Protection diode (A1-, A2+)	0-1415037-1
PTM U0 524	RC-network 6...60 Vac	1-1415037-1
PTM U0 730	RC-network 110...230 Vac	2-1415037-1
PTM V0 524	Varistor 24 Vac	3-1415037-1
PTM V0 730	Varistor 230 Vac	4-1415037-1

LED

PTM L0 524	red LED 6...24 Vdc/Vac	6-1415036-1
PTM G0 524	green LED 6...24 Vdc/Vac	3-1415036-1
PTM L0 024	red LED 6...24 Vdc w. prot.diode (A1+, A2-)	5-1415036-1
PTM G0 024	green LED 6...24 Vdc w. prot.diode (A1+, A2-)	2-1415036-1
PTM L1 024	red LED 6...24 Vdc w. prot. diode (A1-, A2+)	8-1415036-1
PTM L0 730	red LED 110...230 Vac	7-1415036-1
PTM G0 730	green LED 110...230 Vac	4-1415036-1



F0231-A



F0232-A

Accessories Miniature Relay PT

and similar design: relay heights 29 / 34.6 / 35.2 / 36.6 / 37.6mm

Dimensions in mm

PT DIN-rail socket with screw type terminals

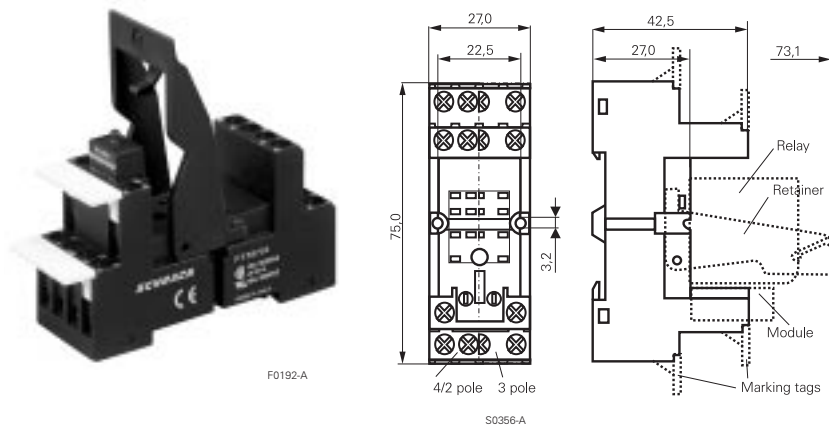

Technical data

Rated current	4 x 6 A, 3 x 10 A, 2 x 12 A
Rated voltage	300 Vac
Dielectric strength coil/cont.	>4000 V _{eff}
Insulation category (VDE 0110b)	C / 250 Vac
Ambient temperature	-45...+70 °C ¹⁾
Protection category	IP 20
Protection against accidental contact meets	VBG 4
Wire cross section	2 x 2.5 mm ²
with bootlace crimp	2 x 1.5 mm ²
Terminal torque	0.5 Nm
max.	0.8 Nm
Packaging unit	10 pcs.

¹⁾ at rated current to +40 °C, up to +70 °C at 70% of rated current

DIN-rail socket with screw type terminals

Type		Part Number
PT 78 702	DIN-rail socket with screw type terminals, 2 pole	9-1419111-9
PT 78 703	DIN-rail socket with screw type terminals, 3 pole	0-1419112-1
PT 78 704	DIN-rail socket with screw type terminals, 4 pole	0-1419112-2

Accessories for PT 78 702, PT 78 703, PT 78 704

Type		Part Number
PT 16 016	Plastic retaining clip PT, relay height 29 mm	3-1419111-8
PT 28 800	Metal retaining clip PT, relay height 29 mm	5-1419111-9
ZG 28 801	Metal retaining clip, relay height 36 mm	1-1393162-5
PT 16 040	Marking tag	3-1419111-9

LED- and Protection Modules for PT 78 702, PT 78 703, PT 78 704

Easy insertion of module into the socket

Wiring in parallel to the coil

Type		Part Number
RPM T0 0A0	Protection diode 1N4007 ¹⁾	1-1393161-1
RPM U0 548	RC-network 24...48 Vac	1-1393161-3
RPM U0 730	RC-network 110...230 Vac	1-1393161-4

LED

RPM L0 024	red LED 12...24 Vdc w.prot.diode ¹⁾	0-1393161-4
RPM G0 024	green LED 12...24 Vdc w.prot.diode ¹⁾	0-1393161-3
RPM L0 524	red LED 12...48 Vdc / Vac	0-1393161-7
RPM G0 524	green LED 12...48 Vdc / Vac	2-1419152-4
RPM L0 110	red LED 60...110 Vdc w.prot.diode ¹⁾	0-1393161-6
RPM G0 110	green LED 60...110 Vdc w.prot.diode ¹⁾	2-1419152-3
RPM L0 730	red LED 110...230 Vac	0-1393161-8
RPM G0 730	green LED 110...230 Vac	2-1419152-5

¹⁾ Standard polarity: A1+, A2-

F0123-A



Accessories Miniature Relay PT

and similar design: relay heights 29 / 34.6 / 35.2 / 36.6 / 37.6mm

Dimensions in mm
View on solder pins

PT 78 600 Socket with solder terminals, 4 pole



F0132-A

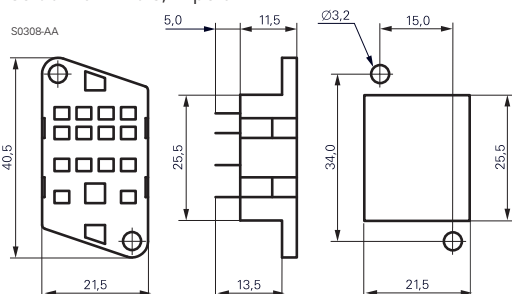

Chassis cut-out

Technical data

Rated current	10 A
Rated voltage	250 Vac
Dielectric strength coil/cont.	>1500 V _{rms}
Ambient temperature	-40...+70 °C
Packaging unit	25 pcs.

PT 78 604 4 pole Socket with PCB terminals

PT 78 603 3 pole

PT 78 602 2 pole



F0133-A

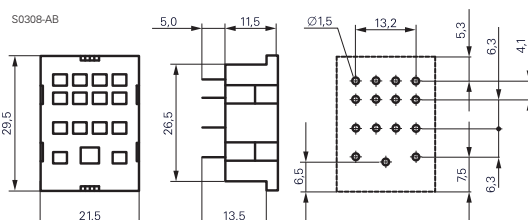

Technical data

Rated current	10 A
Rated voltage	250 Vac
Dielectric strength coil/cont.	>1500 V _{rms}
Ambient temperature	-40...+70 °C
Packaging unit	25 pcs.

PT 78 601 Socket with solder terminals, 4 pole



F0134-A

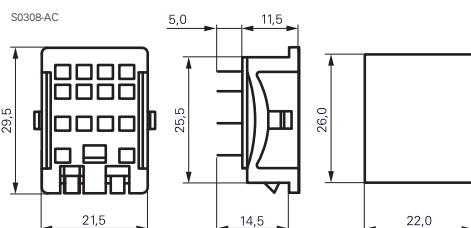

Chassis cut-out

Technical data

Rated current	10 A
Rated voltage	250 Vac
Dielectric strength coil/cont.	>1500 V _{rms}
Ambient temperature	-40...+70 °C
Packaging unit	25 pcs.

PT sockets

Type	Part Number
PT 78 600 Socket with solder terminals, 4 pole	4-1415043-1
PT 78 602 Socket with PCB terminals, 2 pole	5-1415043-1
PT 78 603 Socket with PCB terminals, 3 pole	0-1393162-5
PT 78 604 Socket with PCB terminals, 4 pole	3-1415043-1
PT 78 601 Socket with solder terminals, 4 pole	6-1415043-1

Accessories for PT 78 600, PT 78 601, PT 78 602, PT 78 603, PT 78 604

Type	Part Number
PT 28 802 Metal retaining clip PT, relay height 29 mm	0-1393162-1
ZG 28 800 Metal retaining clip, relay height 36 mm	1-1393162-4

Accessories Multimode Relay MT

and similar design: octal / undecal



F0235-A

Features

- Snap-on mounting on DIN-rail
- Screw mounting
- Pozidrive screws with rising clamp terminals
- Logical layout of input/output connections
- White marking area

Dimensions in mm

MT DIN-rail sockets with screw-type terminals

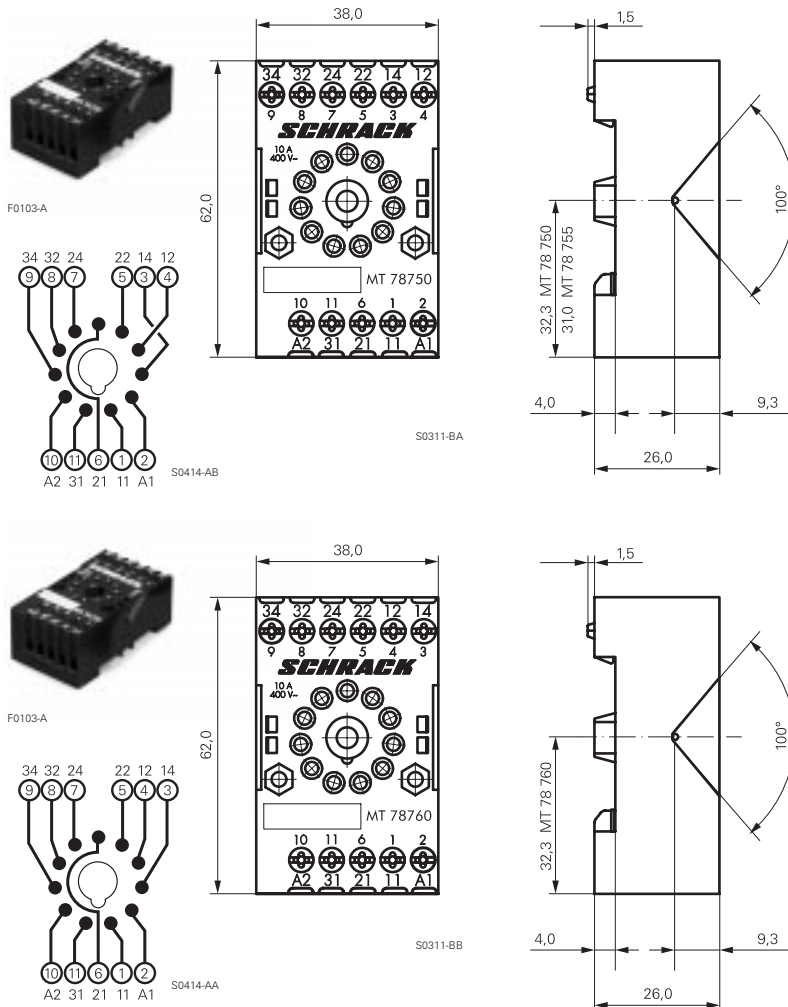

F0103-A

S0414-AB

S0311-BA

F0103-A

S0414-AA

S0311-BB

MT 78 750 MT3 DIN-rail socket with screw-type terminals 11 pole

MT 78 755 MT2 DIN-rail socket with screw-type terminals 8 pole



Technical data

Rated current	10 A
Rated voltage	400 Vac
Dielectric strength coil/cont.	>3500 V _{rms}
Insulation cat. (VDE 0110b)	C / 400 Vac
Tracking resistance	CTI 300
Ambient temperature	+80 °C
Protection category	IP 20
Protection against accidental contact meets	VBG 4
Mounting	DIN 50024 / 22
Wire cross section	2 x 2.5 mm ²
Terminal torque	0.8 Nm
max.	1.0 Nm
Packaging unit	25 pcs.

MT 78 760 MT3 DIN-rail socket with screw-type terminals 11 pole



Technical data

Rated current	10 A
Rated voltage	400 Vac
Dielectric strength coil/cont.	>3500 V _{rms}
Insulation cat. (VDE 0110b)	C / 400 Vac
Tracking resistance	CTI 300
Ambient temperature	+80 °C
Protection category	IP 20
Protection against accidental contact meets	VBG 4
Mounting	DIN 50024 / 22
Wire cross section	2 x 2.5 mm ²
Terminal torque	0.8 Nm
max.	1.0 Nm
Packaging unit	25 pcs.

DIN-rail sockets with screw-type terminals

Type		Part Number
MT 78 750	MT3 DIN-rail socket with screw-type terminals 11 pole	0-1415035-1
MT 78 755	MT2 DIN-rail socket with screw-type terminals 8 pole	3-1415035-1
MT 78 760	MT3 DIN-rail socket with screw-type terminals 11 pole	8-1415034-1

Accessories for MT 78 750, MT 78 755, MT 78 760

MT 28 800	Metal retaining clip MT	8-1393163-0
------------------	-------------------------	-------------

Accessories Multimode Relay MT

and similar design: octal / undecal

Dimensions in mm

MT 78 740 MT3 DIN-rail socket with screw-type terminals 11 pole

MT 78 745 MT2 DIN-rail socket with screw-type terminals 8 pole

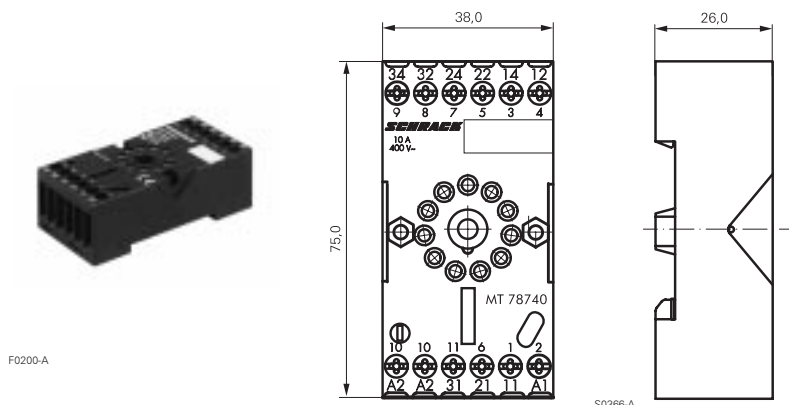

Technical Data

Rated current	10 A
Rated voltage	400 Vac
Dielectric strength coil/cont.	>3000 V _{eff}
Ambient temperature	+80 °C
Protection category	IP 20
Protection against accidental contact meets	VBG 4
Mounting/DIN rail	DIN50022
Wire cross section	2 x 2,5mm ²
Terminal torque	0.8 Nm
Packaging unit	10 Stk.

DIN-rail socket with screw-type terminals

Type		Part Number
MT78 740	DIN-rail socket with screw-type terminals, 11 pole	8-1393163-3
MT78 745	DIN-rail socket with screw-type terminals, 8 pole	8-1393163-4

Socket system MT 78 740 and MT 78 745

- 8/11 pin socket for MT2 / MT3
- Double A2 screw for simple further connection of coil supply

Accessories for MT 78 740, MT 78 745

Type		Part Number
MT 28 800	Metal retaining clip MT	8-1393163-0

LED and Protection modules for MT 78 740, MT 78 745

Type		Part Number
MTM T0 0A0	Protection diode 1N4007	7-1393163-6
MTM U0 524	RC-network 6...24 Vac	7-1393163-7
MTM U0 730	RC-network 110...230 Vac	7-1393163-8

LED

MTM L0 024	red LED 24 Vac / Vdc	7-1393163-4
MTM G0 024	green LED 24 Vac / Vdc	6-1419149-6
MTM L0 730	red LED 110...230 Vac / Vdc	7-1393163-5
MTM G0 730	green LED 110...230 Vac / Vdc	6-1419149-7

Function modules for MT 78 740, MT 78 745

Type		Part Number
MTM Z0 W00	Delay ON	7-1393163-9
MTM F0 W00	Multifunction	7-1393163-3

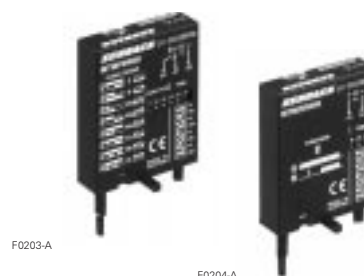

Technical data - Function modules

Nominal voltage	24...240 Vdc / Vac
Mains frequency	48...63 Hz
Precision of time setting	± 0,5 %
Readiness for repetition	≤ 0,5 % or 5 ms
Influence of temperature	≤ 0,1 %/°C
Time range switchable	0,05s...240h in 8 ranges
Ambient temperature	-25...+55 °C

Accessories Multimode Relay MT

and similar design: octal / undecal

Dimensions in mm
View on solder pins

Function modules for MT 78 740, MT 78 745	
Function	
Delay ON	
Delay OFF	
single shot leading edge	
single shot trailing edge	
Delay ON triggered by signal contact	
single shot	
flasher starting with pause	
flasher starting with pulse	

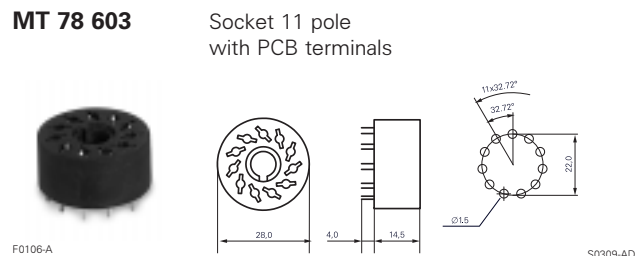
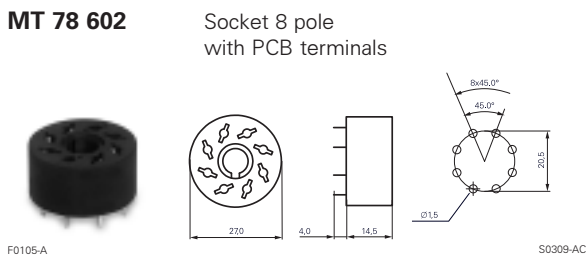
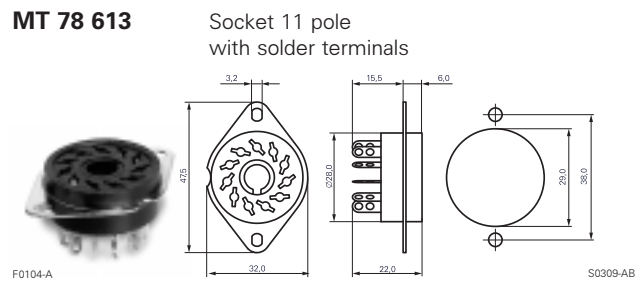
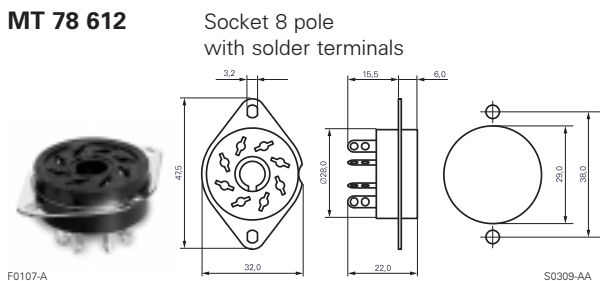

Sockets with solder and PCB terminals		Part Number
Type		
MT 78 612	Socket 8 pole with solder terminals	7-1415043-1
MT 78 613	Socket 11 pole with solder terminals	8-1415043-1
MT 78 602	Socket 8 pole with PCB terminals	9-1415043-1
MT 78 603	Socket 11 pole with PCB terminals	0-1415044-1

Technical data MT78602...MT78613	
Rated current	10 A
Rated voltage	250 Vac
Dielectric strength coil/cont.	>2500 V _{rms}
Ambient temperature	-40...+70 °C
Packaging unit	25 pcs

Accessories Miniature Power Relay PCLH and similar design

Dimensions in mm



F0236-A

PCLH socket with screw-type terminals

TM 78 700 Socket with screw-type terminals

F0129-A

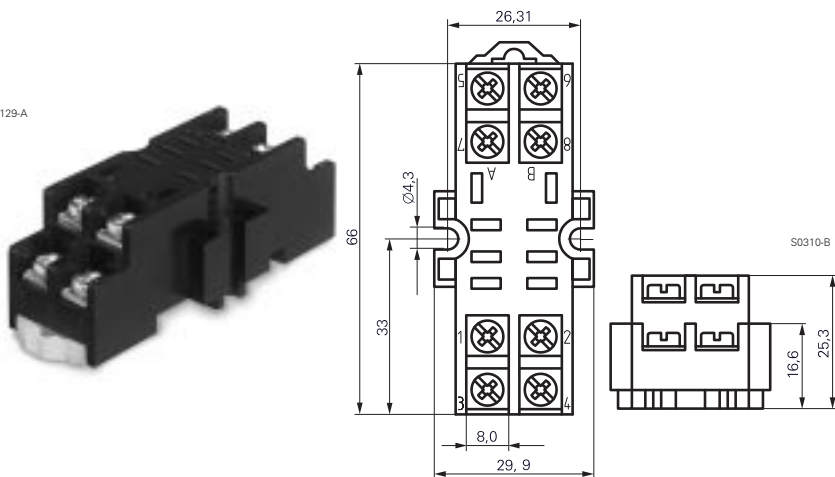

Technical data	
Rated current	10 A
Rated voltage	300 Vac
Protection category	IP 20
Packaging unit	100 pcs.

Socket with screw-type terminals		
Type		Part Number
TM 78 700	Socket with screw-type terminals	0-1393164-2

Accessories for TM 78 700		
Type		Part Number
TM 28 800	Metal retaining clip for PCLH	0-1393164-1

Accessories Power Relay RM

2 / 3 pole, 10 / 16 A

Dimensions in mm



F0237-A

RM Sockets with screw-type terminals

RM 78704 Socket with screw-type terminals



F0113-A

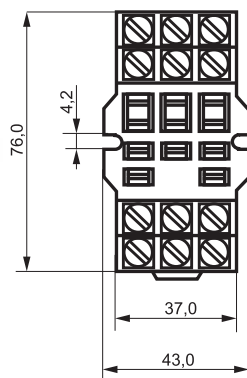

S0317-A

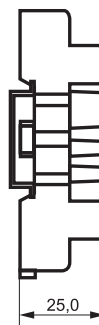

Technical data

Rated current	16 A
Rated voltage	380 Vac
Dielectric strength coil/cont.	>2500 V _{rms}
Ambient temperature	-40...+50 °C
Terminal torque	0.8 Nm
max.	1.2 Nm
Packaging unit	100 pcs.

RM 78 705 Socket with screw-type terminals



F0114-A

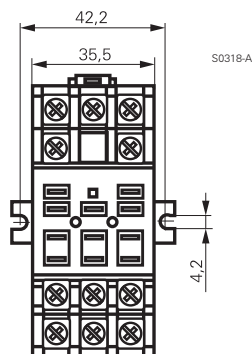

S0318-A

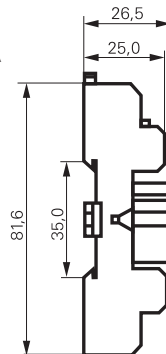

Technical data

Rated current	16 A
Rated voltage	250 Vac
Dielectric strength coil/cont.	>2500 V _{rms}
Ambient temperature	-40...+40 °C
Terminal torque	0.8 Nm
max.	1.2 Nm
Packaging unit	100 pcs.

Socket with screw-type terminals

Type	Part Number
RM 78 704 Socket with screw-type terminals	2-1393844-4
RM 78 705 Socket with screw-type terminals	2-1393844-5

Accessories Power Relay RM

2 / 3 pole, 10 / 16 A

Dimensions in mm
View on solder pins

RM 78 700 Socket with Faston terminals



F0110-A

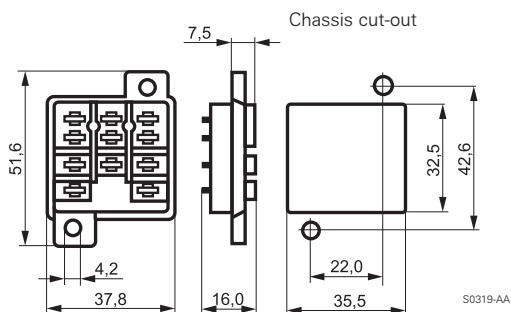

RM 78 701 Socket with solder terminals



F0111-A

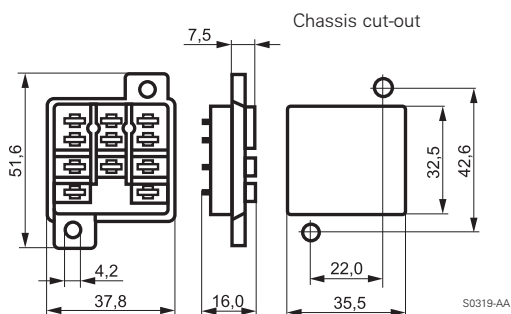

RM 78 702 Socket with PCB terminals

 300 Vac / 10 A



F0112-A

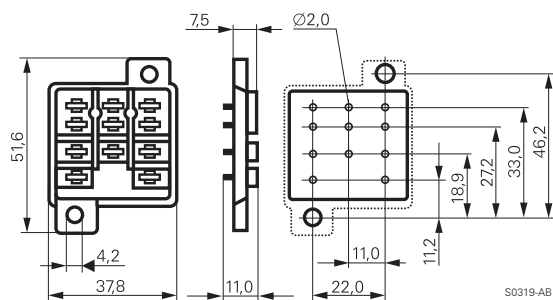

Sockets

Type	Part Number
RM 78 700 Socket with Faston terminals	0-1419118-6
RM 78 701 Socket with solder terminals	4-1393149-9
RM 78 702 Socket with PCB terminals	2-1393844-3

Accessories for RM 78 700, RM 78 701, RM 78 702

Type	Part Number
RM 28 802 Metal retaining clip RM	0-1419118-5

Relay Package SNR

1 pole 6 A, DC coil



F0252-A

Features

- Relay package consisting of DIN-rail socket, mounting frame and relay and optional LED
- Module width only 5.08 mm
- Reduced system width for increased packing density on the DIN rail



Technical data of approved types on request

Package data

Configuration	1 C/O contact
Rated current	6 A
Nominal voltage	24...48 Vdc
Dielectric strength coil-contacts	4 kV / 8 mm
Module width	5.08 mm
Packaging unit	10 pcs.
Complete relay data see	Slim Interface Relay SNR
Data on sockets	see accessories SNR

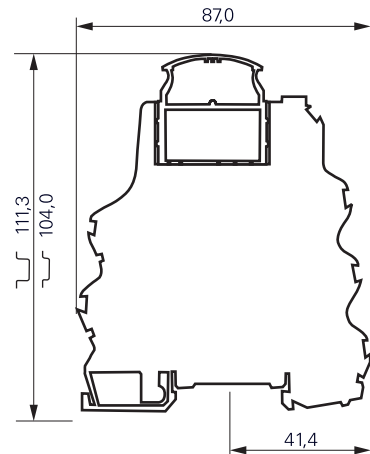

F0404-A

Product key



Type

Version

1P 1 C/O contact, 6 A

Contact material

2 AgSnO₂ gold plated

3 AgSnO₂

Electrical indicator

0 without indicator

L LED

Coil

DC coil code = nominal voltage (e.g. 24=24Vdc)

Other types on request

Product key	Socket	Mtg. frame	Relay	Coil	Part number
ST1P2L24	ST1FL24	ST16016	V23092-A1024-A201	24 Vdc	6-1415025-1
ST1P3024	ST1F000		V23092-A1024-A301		3-1415024-1
ST1P3L12	ST1FL24		V23092-A1012-A301	12 Vdc	2-1415025-1
ST1P3L24			V23092-A1024-A301	24 Vdc	3-1415025-1
ST1P3L48			V23092-A1048-A301	48 Vdc	4-1415025-1

Relay Package RT

1 pole 16 A, 2 pole 8 A, DC- or AC coil



F0251-A

Features

- Relay package consisting of RT relay, DIN-rail socket, plastic retaining clip, module and marking tag
- 1 C/O or 1 N/O with 16 A or 2 C/O with 8 A rated load
- Sensitive DC- or AC coil
- Protection class II / VDE 0700, safe separation to VDE 0106



Technical data of approved types on request

Package data

Configuration	1 C/O, 1 N/O	2 C/O
Rated current	16 A	8 A
Nominal voltage	24 Vdc 24, 230 Vac	
Dielectric strength coil-contacts	4 kV / 8 mm	
Module width	15.5 mm	
Packaging unit	10 pcs.	
Complete relay data see	Interface Power Relay RT	
Data on sockets	see accessories RT	

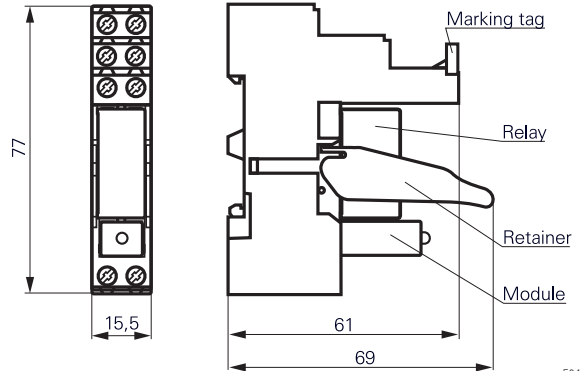

F0430-A

Product key

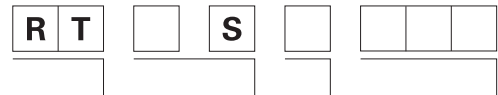

Type

Version

3S Relay set: RT 1-pole C/O or N/O, 16 A, red LED

4S Relay set: RT 2-pole C/O, 8 A, red LED

Contact material

4 AgNi 90/10, C/O contact

K AgNi 90/10 inrush, N/O contact

5 AgNi 90/10 gold plated, C/O contact

L AgSnO₂ inrush, N/O contact

Coil

LC4 24 Vdc

R24 24 Vac

T30 730 Vac

Other types on request

Product key	Socket	Retainer	Marking tag	Module	Relay	Coil	Part number
RT3S4LC4	RT78726	RT17016	RT17040	PTML0024	RT314024	24 Vdc	4-1415073-1
RT3S4R24				PTML0524	RT314524	24 Vac	5-1415073-1
RT3S4T30				PTML0730	RT314730	230 Vac	6-1415073-1
RT3S5LC4				PTML0024	RT315024	24 Vdc	7-1415073-1
RT3S5R24				PTML0524	RT315524	24 Vac	8-1415073-1
RT3S5T30				PTML0730	RT315730	230 Vac	9-1415073-1
RT3SKLC4				PTML0024	RT33K024	24 Vdc	3-1415074-1
RT3SLLC4					RT33L024		4-1415074-1
RT4S4LC4					RT424024		1-1415073-1
RT4S4R24				PTML0524	RT424524	24 Vdc	2-1415073-1
RT4S4T30				PTML0730	RT424730	230 Vac	3-1415073-1
RT4S5LC4				PTML0024	RT425024	24 Vdc	0-1415074-1
RT4S5R24				PTML0524	RT425524	24 Vac	1-1415074-1
RT4S5T30				PTML0730	RT425730	230 Vac	2-1415074-1

Relay Package PT

2 pole 12 A, 3 pole 10 A or 4 pole 6 A
DC- or AC coil



F0253-A

Features

- Relay package consisting of PT relay, DIN-rail socket, plastic retaining clip, module and marking tag
- 2, 3 or 4 C/O
- Mechanical and electrical indicator
- Manual test tab, optionally lockable



Technical data of approved types on request

Package data

Configuration	2 C/O	3 C/O	2 C/O
Rated current	12 A	10 A	6 A
Nominal voltage	12, 24 Vdc 24, 230 Vac		
Module width	27.0 mm		
Packaging unit	5 pcs.		
Complete relay data see	Miniature Relay PT		
Data on sockets	see accessories PT		

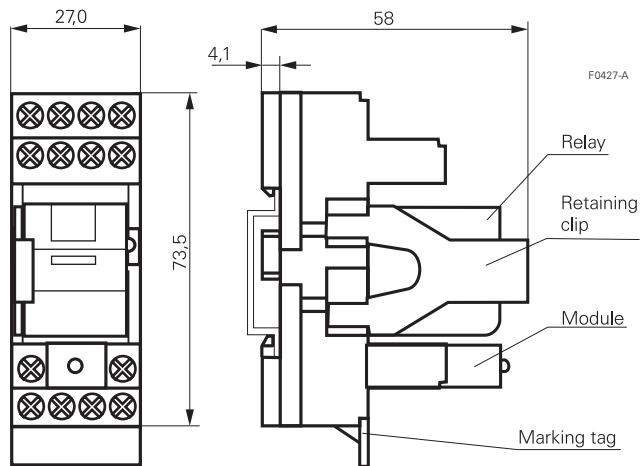

F0427-A

Product key

Type

Contact configuration

- 2S** Relay set: PT 2 C/O contacts, red LED
- 3S** Relay set: PT 3 C/O contacts, red LED
- 5S** Relay set: PT 4 C/O contacts, red LED

Contact material

- 7** AgNi 90/10, with test button
- 8** AgNi 90/10, gold plated, with test button

Coil

- LB2** 12 Vdc
- RC4** 24 Vac
- LC4** 24 Vdc
- TD0** 230 Vac

Other types on request.



Product key	Socket	Retainer	Marking tag	Module	Relay	Coil	Part number
PT2S7LB2	PT78720	PT17016	PT17040	PTML0024	PT270012	12 Vdc	7-1415074-1
PT2S7LC4					PT270024	24 Vdc	8-1415074-1
PT2S7RC4					PT270R24	24 Vac	5-1415074-1
PT2S7TD0					PT270T30	230 Vac	6-1415074-1
PT3S7LB2	PT78730			PTML0024	PT370012	12 Vdc	1-1415075-1
PT3S7LC4					PT370024	24 Vdc	2-1415075-1
PT3S7RC4					PT370R24	24 Vac	9-1415074-1
PT3S7TD0					PT370T30	230 Vac	0-1415075-1
PT5S7LB2	PT78740			PTML0024	PT570012	12 Vdc	9-1415075-1
PT5S7LC4					PT570024	24 Vdc	0-1415076-1
PT5S7RC4					PT570R24	24 Vac	7-1415075-1
PT5S7TD0					PT570T30	230 Vac	8-1415075-1
PT5S8LB2				PTML0024	PT580012	12 Vdc	5-1415075-1
PT5S8LC4					PT580024	24 Vdc	6-1415075-1
PT5S8RC4					PT580R24	24 Vac	3-1415075-1
PT5S8TD0					PT580T30	230 Vac	4-1415075-1

Thermal Circuit Breaker W28



F0214-A

Features

- Approved to international standards (push to reset type)
- Labor-saving snap-in mounting
- tested to EN 60934



Technical data of approved types on request

Electrical data

Calibration	0.25...2 A models:	will continuously carry 100% of rating may trip at 101...174%, but must trip at 175% of rating within one hour at +25°C
	3...16 A models:	may trip at 101...134%, but must trip at 135% of rating within one hour at +25°C
Maximum operating voltage		32 Vdc; 250 Vac 50/60 Hz
Interrupt capacity		1000 A at 250 Vac, 50/60 Hz; 32 Vdc in accordance with UL 1077
Resettable overload capacity	0.25...2 A models:	6x rated current
	3...16 A models:	10x rated current
Reset time	0.25...2 A models:	max 180 s
	3...16 A models:	110...60 s
Dielectric strength		1500 Vrms

Typical resistance vs. current rating

Current rating	Typical resistance	Current rating	Typical resistance	Current rating	Typical resistance
A	Ω	A	Ω	A	Ω
0.25	14.0	5.0	0.030	12.0	0.009
0.50	3.55	6.0	0.026	13.0	0.009
0.75	2.0	7.0	0.017	14.0	0.007
1.0	0.89	8.0	0.016	15.0	0.007
2.0	0.17	9.0	0.014	16.0	0.007
3.0	0.069	10.0	0.011		
4.0	0.043	11.0	0.010		

Data for ambient temperature +25°C

Time vs. current trip curve

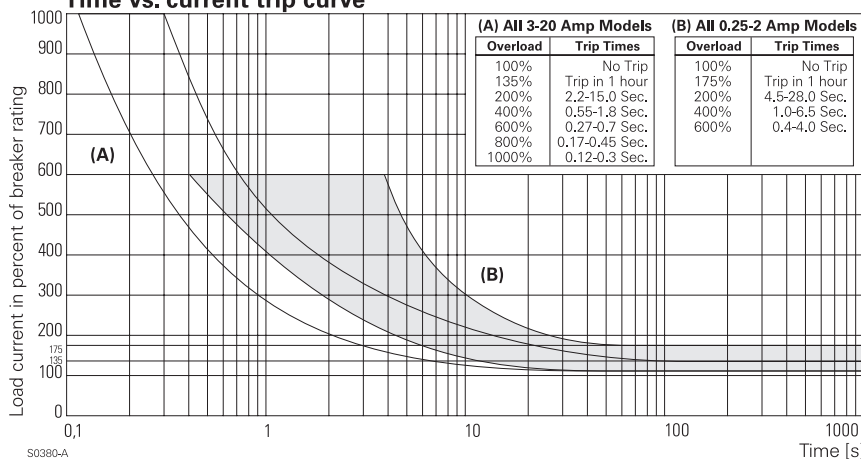

Ambient compensation chart

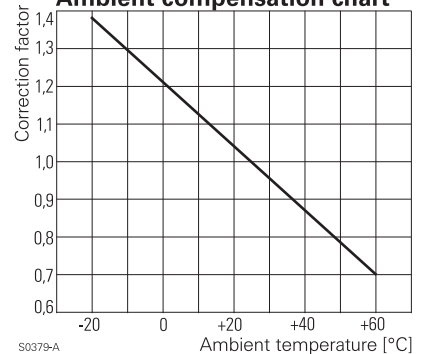

How to use the correction: Multiply the breaker rating by correction factor to determine the compensated rating. Calculate the overloads in terms of the compensated rating to use the published trip curve.

Thermal Circuit Breaker W28

Other data	
Ambient temperature	-20...+60°C
Terminals	6.35mm (.250") quick connects soldering to terminals not recommended
Mounting	snaps into panel from front
Weight	10 g
Packaging unit	100 pcs.

Dimensions

Dimensions in mm

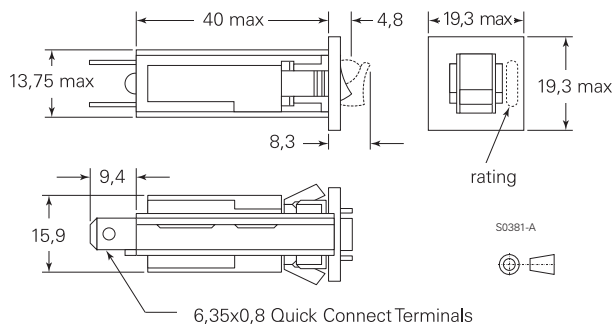

Recommended panel cutouts

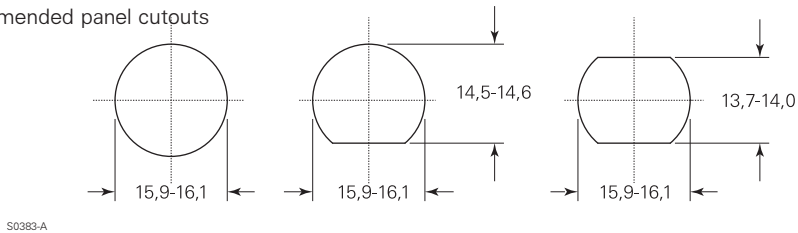

Lockwasher

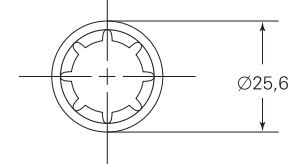

55-025B
Internal tooth push-on lockwasher
for panel thickness >2,7mm

Product key

W 2 8 - X **1** **A** -

Type

Circuit function

X series trip, push-to-reset button

Terminal type and mounting

Q 6,35mm Quick Connect for panel thickness 0.8...1.6mm

T 6,35mm Quick Connect for panel thickness 1.9...2.7mm
for panels other than above, order "Q" type and 55-025B internal
tooth push-on lockwasher

Front color

1 black with white rating marking

Button color

A black

Current rating

0.25, 0.50, 0.75, 1, 2, 3, 4, 5, 6, 7, 8, 9,
10, 11, 12, 13, 14, 15, 16

Preferred types in bold print. Other types on request.

Thermal Circuit Breaker W58



F0215-A

Features

- 0.5...25 A ratings
- Cannot be manually tripped
- Push button to reset breaker

 Recognized as supplementary protectors
 Technical data of approved types on request

Electrical data

Calibration	will continuously carry 100% of rating may trip at 101...144%, but must trip at 145% of rating at +25°C
Maximum operating voltage	50 Vdc; 250 Vac 50/60Hz
Interrupt capacity	2000 A at 50 Vdc 1000 A at 250 Vac 50/60Hz
Resettable overload capacity	10x rated current
Dielectric strength	> 1500 Vrms

Typical resistance vs. current rating

Current rating	Max. resistance	Current rating	Max. resistance	Current rating	Max. resistance
A	Ω	A	Ω	A	Ω
0.5	5.0	5.0	0.026	10.0	0.014
1.0	1.35	6.0	0.026	12.0	0.010
2.0	0.32	7.0	0.020	15.0	0.010
3.0	0.18	8.0	0.020	20.0	0.006
4.0	0.10	9.0	0.020	25.0	0.005

Data for ambient temperature +25°C

Time vs. current trip curve

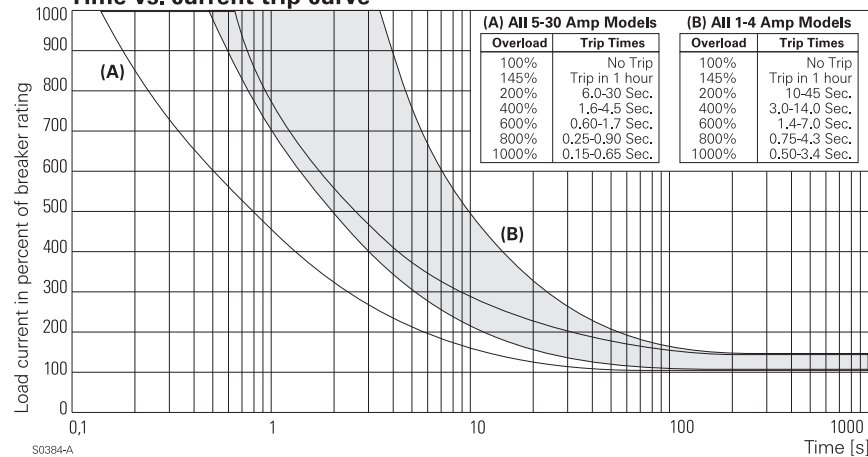

S0384-A

Ambient compensation chart

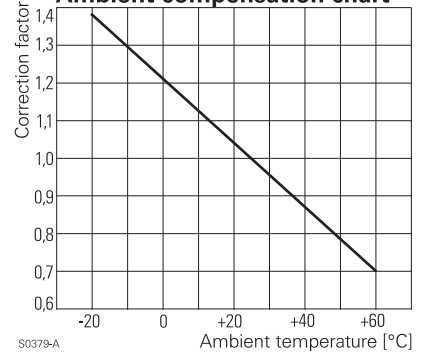

S0379-A

How to use the correction: Multiply the breaker rating by correction factor to determine the compensated rating. Calculate the overloads in terms of the compensated rating to use the published trip curve.

Thermal Circuit Breaker W58

Other data	
Ambient temperature	-20...+60°C
Endurance cycling	> 1000 operations at 200% of rating
Vibration resistance	10g at 10...55 Hz
Weight	42 g
Packaging unit	100 pcs.

Mounting Hardware

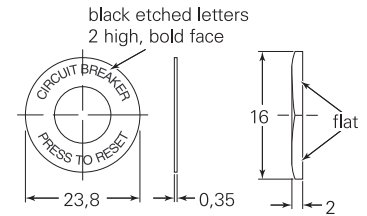

S0386-A

Dimensions

Dimensions in mm

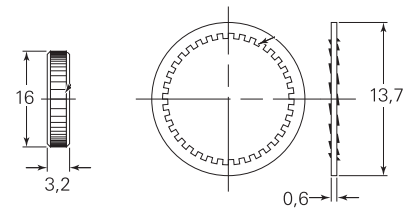
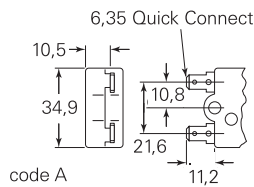
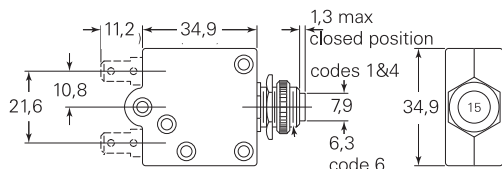

Mounting bushing

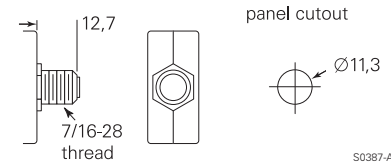
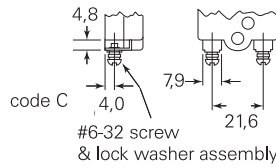
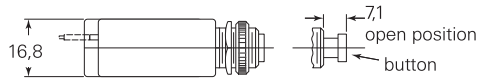

S0387-A

S0385-A



Ordering key

W 5 8 - X B 1 [] [] A - []

Type

Circuit function

X series trip

Button

B white with red rating marking, red trip band

Mounting bushing

1 7/16"x0.5" (12,7mm) long

Terminals

A Quick Connect 6.35mm straight

C 6/32 screw 90° (screws installed)

Mounting hardware

4 knurled nut/hex nut

12 knurled nut/lock washer

Mounting hardware packaging

A assembled to bushing

Current rating in Amps

0.5, 1, 2, 3, 4, 5, 6, 7, 8, 9, 10, 12, 15, 20, 25

Preferred types in bold print. Other types on request

Magnetic Hydraulic Circuit Breaker W6 / W9



F0216-A

Features

- UL, CSA and VDE approved
- Ratings to 50 A
- Heavy duty stud connections
- Several delay curve options
- Trip free operation
- tested to EN 60934



Technical data of approved types on request

Electrical data

Calibration	will hold 100% of rated current may trip at 101...124% of rated load (134% for AC/DC units). must trip at 125% of rated load and above (135% for AC/DC units)
Endurance	10x10 ³ on/off cycles - 6000 at rated load, 4000 without load tested at 6 cycles/min, 1 s on and 9 s off at 25°C
Dielectric strength	50/60 Hz: 1500 Vrms DC: 1100 Vdc
Insulation resistance	100x10 ⁶ Ohm

Typical resistance and impedance

Current rating	DC resistance	50/60 Hz Impedance
A	Ω	Ω
0.2	90	90
1.0	1.2	1.2
2.0	0.28	0.28
5.0	0.04	0.04
10.0	0.013	0.013
20.0	0.004	0.005
30.0	0.0027	0.004
40.0	0.002	0.002
50.0	0.0015	0.0015

Data for ambient temperature +25°C

Approval and ratings

W6 series

Max Voltage	Frequency	Phase	Current Rating	Interruption Capacity
V	Hz		A	A
65	DC	-	0.2...50	2000
250	50/60	1	0.2...30	5000
250	50/60	1	31...50	2000
415/240	50/60	3	0.2...30	5000

Approval and ratings

W9 series

Max Voltage	Frequency	Phase	Current Rating	Interruption Capacity
V	Hz		A	A
65	DC	-	0.2...50	2000
250	50/60	1	0.2...30	5000
250	50/60	1	31...50	2000
415/240	50/60	3	0.2...30	5000

Magnetic Hydraulic Circuit Breaker W6 / W9

Other data

Ambient temperature	-40...+85 °C		
Humidity	meets requirements of Mil-STD-202 method 103		
Fungus and moisture resistance	special moisture resistant finish applied to all ferrous parts, plastic parts are made of inherently fungus resistant material		
Vibration resistance	1.52 mm, 10...55 Hz, tested to Mil-STD-202, method 201		
Shock resistance	100 g, 6 ms, tested to Mil-STD-202, method 213, C		
Marking	W6 units have ON and OFF molded on the rocker ('0','1' for VDE)		
Mounting	screw mount in panels (#6-32 or M3x0.5) to maintain published performance, units should not be mounted more than 45° from their upright position		
Weight	W6: appr. 60 g per pole	W9: appr. 90 g per pole	
Packaging unit	W67: 72 pcs.	W91: 55 pcs.	
	W68: 36 pcs.	W92: 30 pcs.	
	W69: 24 pcs.	W93: 20 pcs.	
	W70: 9 pcs.	W94: 9 pcs.	

Time vs. current trip curves for W6 and W9 series

AC

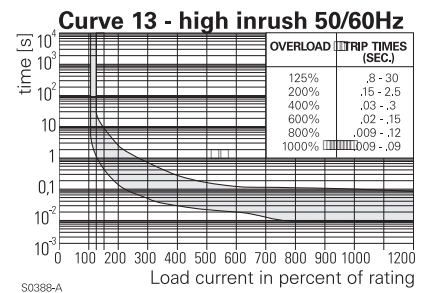
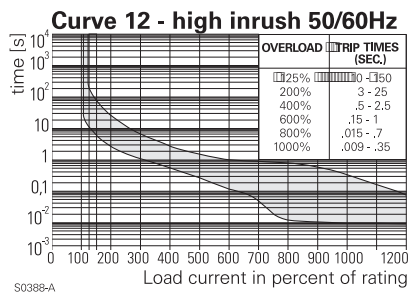
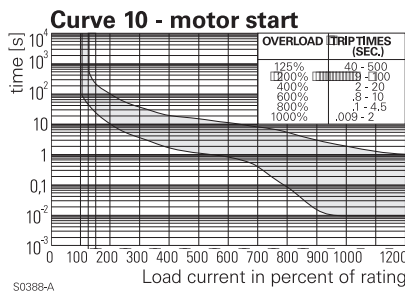
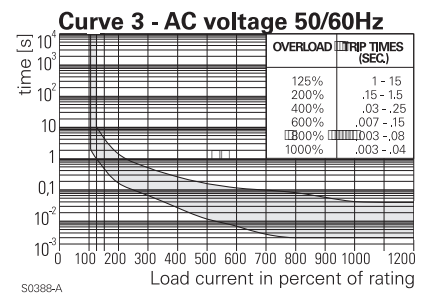
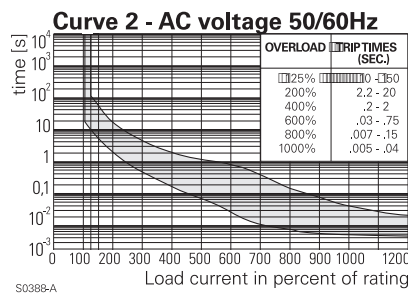
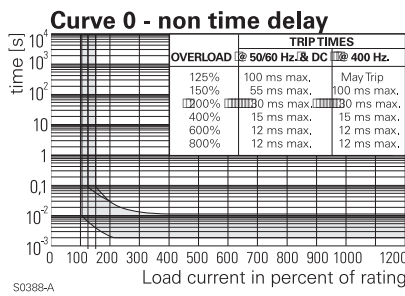

DC; AC/DC

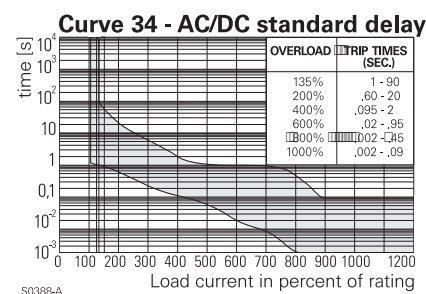
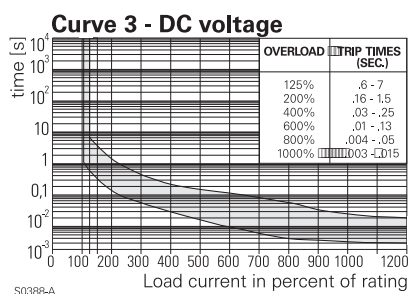
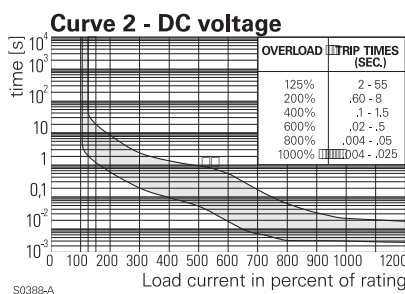

Magnetic Hydraulic Circuit Breaker W6 / W9

Pulse tolerance specifications

Voltage	Time delay curve	Pulse tolerance value	
		Standard	Inertia delay
AC 50/60Hz	2	7.5	18
AC 50/60Hz	3	6	18
AC 50/60Hz	10	18	30
AC 50/60Hz	12	18	30
AC 50/60Hz	13	18	30

Pulse tolerance is defined as a single pulse of a half sine wave (1/2 cycle or 8ms) that will not trip the breaker. An inertia wheel for increased pulse tolerance is available by specifying 'P' after the time delay curve number in the ordering key. The table at left lists pulse tolerance values of standard and inertia delay models.

To determine pulse tolerance multiply breaker rating by value in table. For example, a 2 A breaker with time delay curve 3 has a standard pulse tolerance of 12 A (2x6 A). The same breaker with an inertia delay has a pulse tolerance of 36 A (2 Ax18).

Dimensions

Dimensions in mm

W6 series

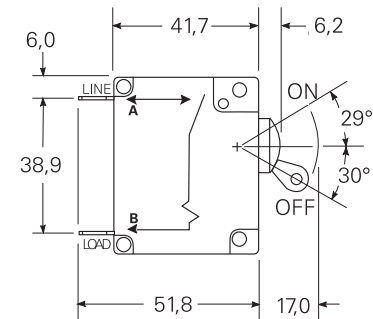

S0389-A

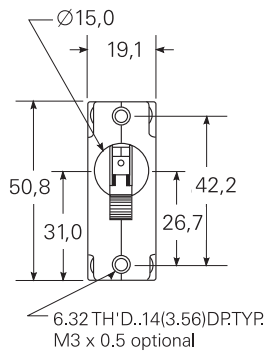

S0390-A

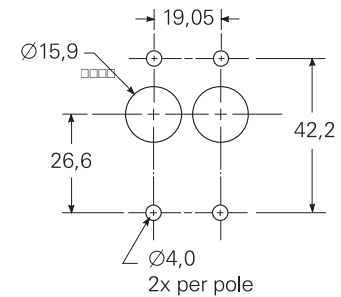

S0394-A

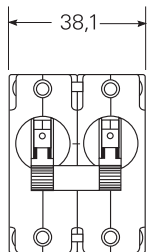

S0391-A

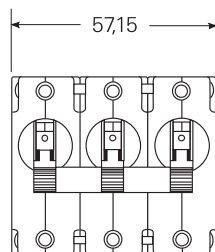

S0392-A

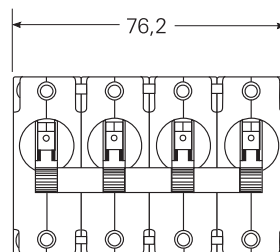

S0393-A

VDE models

with screw terminals

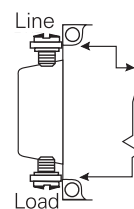

S0395-A

UL/CSA models

with screw terminals

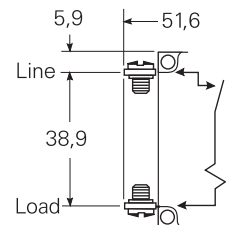

S0396-A

W9 series

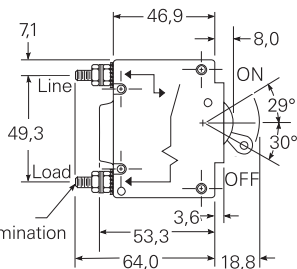

S0397-A

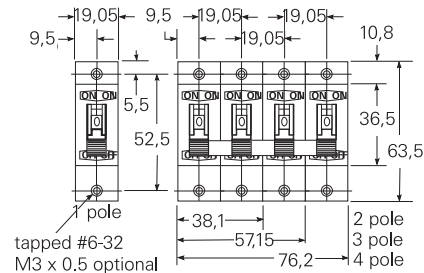

S0398-A

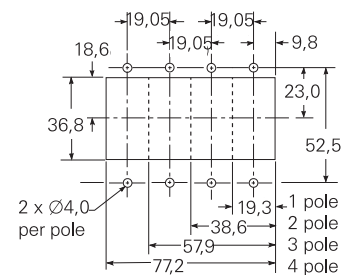

S0399-A

Safety Relays / Definitions

Relays with forcibly guided contacts

General information

Relays with forced guidance contacts play a decisive role in avoiding accidents on machines and in systems. Safety control circuits enable to switch into the fail safe state. Forcibly guided contacts monitor the function of the safety control circuits. For this safety function, all the assumed faults that can occur must already have been taken into consideration and their effects examined. Standard EN 50205 "Relays with forcibly guided contacts" contains current internationally-defined design requirements. Relays with forcibly guided contacts that comply with EN 50205 are also referred as "safety" relays.

Function

Power relays with forcibly guided (linked) contacts: Power relays with at least one break contact and at least one make contact designed that by mechanical means make and break contacts can never be simultaneously in the closed position.

Contact gaps shall never be less than 0.5 mm over the operating life, not only under normal operating conditions, but also when a fault occurs.

This requirement allows the respective exclusive-or contact to detect the fault of a contact to open. For example, the welding of a make contact is indicated by the non-closing of the break contact when the energization is switched off.

To fulfill the specifications of the standard, the assumed faults must be considered:

Assumed fault	Effect
Failure of the contact to open due to welding	The failure of any make contact to open has the effect that none of the break contacts close even when the relay is not energized. The failure of any break contact to open has the effect that none of the make contacts close when the relay is energized.
Failure of the contact to open due to failure of the drive	The drive has no effect on the forcibly guided contact operation.
Breakage of the contact spring	Simultaneous closing of the break and make contacts is not possible even as a result of breakage. Completely insulated contact chambers (SR2, SR4, SR6) or barriers (SR2M) guarantee a contact gap of 0.5 mm.

Safety Relays / Definitions

Application example

The configuration of safety control circuits is basically only possible with specified fault conditions. Safety relays have the characteristic that make and break contacts can never both be closed at the same time.

The following circuit diagram shows an emergency stop control circuit consisting of three 4-pole safety relays.

The first fault to occur

- does not cause the safety function to fail because more components are used than required for the circuit to function (redundancy).
- prevents a restart and can be detected as a result (self monitoring)

Operation

- Closing the "ON" switch causes the K1 relay to be pulled in

- The K2 and K3 relays are energized via the make contacts K1-1 and K1-2 and hold themselves via K2-2 or K3-2
- The break contacts K2-1 and K3-1 cause the drop-out of K1 where the load circuit is released via the break contacts of K1-3 or K1-4.

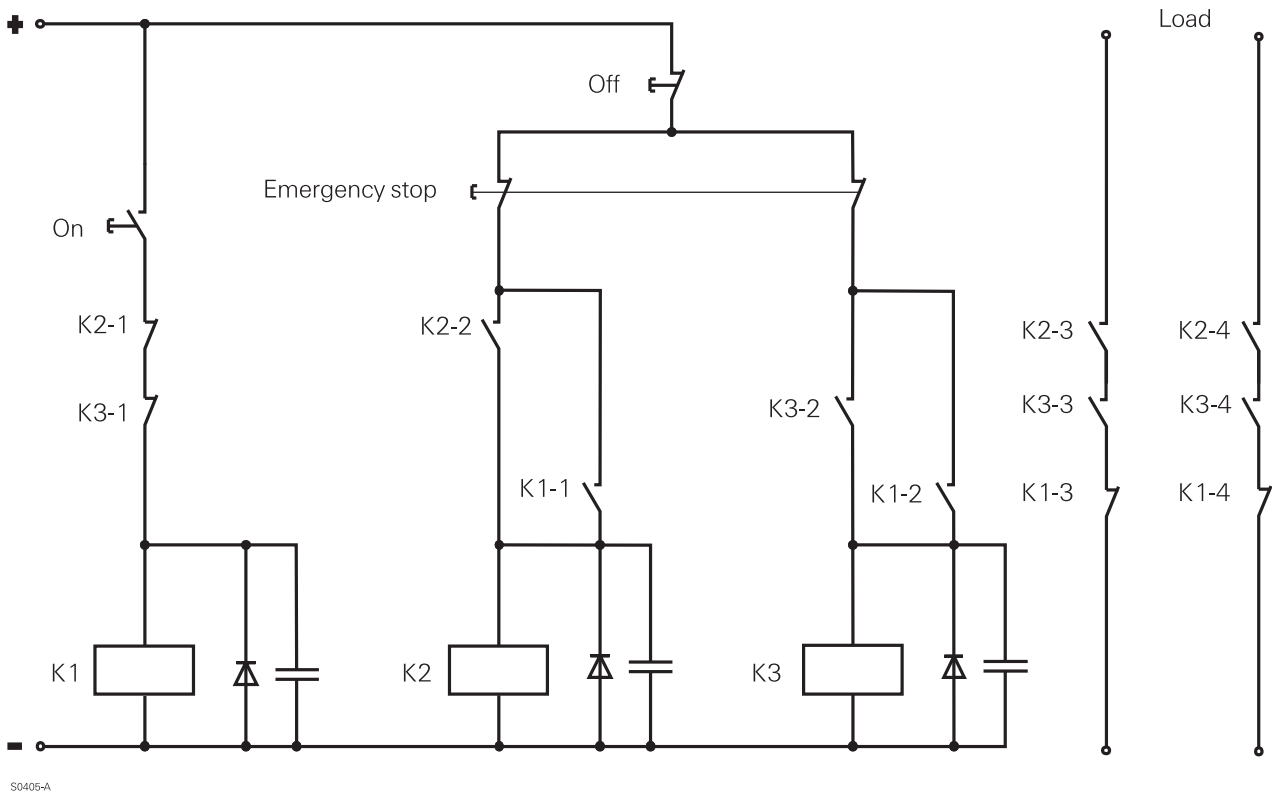

Fault analysis (examples):

Type of fault	Is there any danger arising from the fault?	Is a restart possible?
Failure of contact K2-3 to open	No, K3-3 opens when the emergency stop switch is actuated	No, K2-1 and K2-3 cannot be closed at the same time (fault excluded by forcibly guided). "ON" button does not cause K1 to close
Failure of contact K1-3 to open	No, K2-3 and K3-3 open when the emergency stop switch is actuated	No, K1-1 and K1-2 cannot close due to closed K1-3. K2 and K3 are not energized

Definitions

AC-coil

Relays for direct energization with AC supply. The data is given for a 50 Hz supply.

Unless otherwise stated, the AC-coils may be used with 50 and 60 Hz supply. For 60 Hz data please contact our application support.

Ambient temperature

The temperature in the vicinity of the relay. The minimum ambient temperature is the minimum operating temperature, the maximum ambient temperature is the maximum operating temperature for the use of the relay. This temperature should not be exceeded. Ambient temperature range according to IEC 61810-1.

Approvals

The approvals confirm that the relay corresponds to the respective regulation for electrical components and equipment. The approvals are quoted for the respective relay types. However, they do not always refer to the entire spectrum of types of a relay.

	BEAB	British Electrotechnical Approvals Board, England
	CECCE	VDE-Prüfstelle Offenbach als nationale Überwachungsstelle, Deutschland
	CSA	Canadian Standards Association, Kanada
	DEMKO	Danmarks Elektriske Materielkontrol, Danmark
	KEMA	Naamloze Venootschap tot Keuring van Electrotechnische Materialen, Niederlande
	LLOYD's	Lloyd's Register of Shipping
	NEMKO	Norges Elektriske Materielkontroll, Norwegen
	ÖVE	Österreichischer Verband für Elektrotechnik, Österreich
	SEMKO	Svenska Elektriska Materielkontrollanstalten AB, Schweden
	SETI	Sähkötarkastuskeskus Elinspektionscentralen, Finnland
	SEV	Eidgenössisches Starkstrominspektorat, Schweiz
	TÜV	Technischer Überwachungs-Verein, Deutschland
	UL	Underwriters Laboratories, Inc., USA; UL Component Recognition Mark for the United States
	UL	UL Component Recognition Mark for Canada
	UL	UL Component Recognition Mark for the United States and Canada
	VDE	VDE-Prüfstelle, Deutschland (Gutachten mit Fertigungsüberwachung)

Bistable relay, switching characteristics

In a bistable relay, the contacts remain in the last switching position after the input voltage is disconnected.

Bistable, polarized relay

A polarized bistable relay adopts one switching position on energizing in a particular direction and the other switching

position when the energizing is in the opposite direction. In a bistable relay with one winding, the opposite energizing is created by a voltage with opposite polarity being applied to the same winding.

In a bistable relay with two windings, the opposing energizing is created by a voltage being applied to the second winding with opposite winding sense.

Bistable, remanent relay (remanence relay)

A remanent, bistable relay adopts a particular switching position at an energizing direct current in any direction and is held in this position by the remanence in the magnetic circuit, i.e. through the magnetization of parts of the magnetic circuit. The contacts shift to the other switching position on a small energizing current of limited amplitude in the opposite direction. This demagnetizes the magnetic circuit.

Bounce

An unintentional phenomenon that can occur during the making or breaking of a contact circuit when the contact elements touch successively and separate again before they have reached their final position.

Bounce time

The time (typ.) from the first to the last closing or opening of a relay contact. The indicated times are for energization with nominal voltage (without any components in series or parallel to the coil) and at reference temperature.

Break contact

A contact that is closed in the rest state of the relay and open in the operating state.

Bridging contact

Compound contact with two simultaneously operating make contacts connected in series.

Category of protection (IEC61810)

The 'Relay Technology Categories' describe the degree of sealing of the relay case or its contact unit:

RT 0:	unenclosed relay Relay not provided with a protective case
RT I:	dust protected relay Relay provided with a case which protects its mechanism from dust
RT II:	flux proof relay Relay capable of being automatically soldered without allowing the migration of solder fluxes beyond the intended areas. These are the contacts, movable parts of the magnetic system and their immediate environment.
RT III:	wash tight (washable) relay Relay capable of being automatically soldered and subsequently undergoing a washing process to remove flux residues without allowing the ingress of flux or washing solvents. The test to evaluate the sealing of the case for wash tight relays and is performed according to the IEC 68-2-17, Qc test.

NOTE - In service this type of relay is sometimes vented to the atmosphere after soldering or washing process; in this case the requirements with respect to clearances and creepage distances can change.

RT IV:	sealed relay
RT V:	hermetically sealed relay

Definitions

Changeover contact

Compound contact consisting of a make contact and a break contact with a common terminal. On changing the switch position, the contact previously closed opens first followed by the closing of the contact that was previously open.

Clearance distance

Shortest distance in air between two conductive elements.

Coil operating range

Permissible range for the energizing voltage as function of the ambient temperature. The operating range is defined by the maximum voltage and the operate-/minimal voltage U_{min} (coil without preenergization) and/or the operate-/minimal voltage U_1 (preenergized coil).

Coil operating range for monostable relays with DC- or AC-coil:

- curve 1: operate-/minimal voltage U_0 (without preenergization)
- curve 2: operate-/minimal voltage U_1 (preenergized coil)
- curve 3: maximum voltage U_2 at contact current = 0A
- curve 4: maximum voltage U_2 at rated contact load I_{nom}

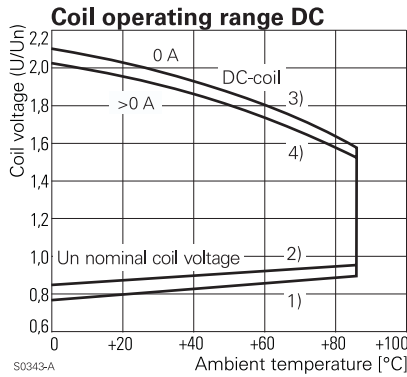

Coil operation range for bistable relays (remanence version)

- curve 1: operate voltage at coil temperature equal to ambient temperature (no preenergization or pulsed operation)
- curve 2: minimum reset/demagnetization voltage
- curve 3: maximum reset/demagnetization voltage at full contact load
- curve 4: maximum voltage at full contact load
- curve 5: maximum voltage at full contact load and pulsed operation (duty cycles)

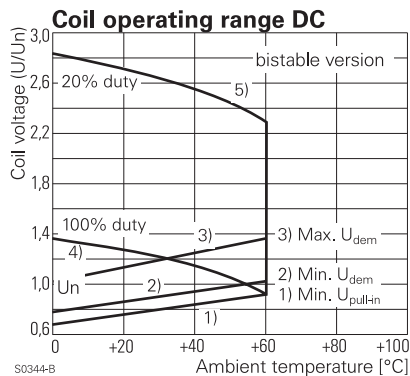

Coil resistance

Electrical resistance of the relay coil at reference temperature.

Contact configuration

According to the different switching functions of the relay contacts the various contact configurations, design and description are specified in DIN 41020. See:

- make contact (N/O)
- break contact (N/C)
- changeover contact (C/O)

Contact	Reference			Circuit diagr.
	D	GB	USA	
N/O contact make cont.	1	A	SPST-NO	
N/C contact break cont.	2	B	SPST-NC	
C/O contact changeover c.	21	C	SPDT	
Bridging N/O	1	X	SPST-NO	
Bridging N/O/ Bridging N/C		X	DM-DB	

Contact material

The list gives an overview of the most important plating- and contact materials. The switching capacity of the contacts and the respective electrical endurance depends not only on the contact material but also to a high degree on the relay design. Decisive for the application therefore is the optimal combination of the mechanical system and the contact material. The characteristics for certain relay types cannot be transferred to other designs.

1) Plating materials:

Fine gold

- best corrosion resistance, not used as solid material because too soft, high tendency towards cold-welding
- gold platings $\leq 1 \mu\text{m}$ (hv), only as storage protection, no protection against aggressive atmosphere.

Hard gold / gold plated (htv)

- very good corrosion resistance, low and stable contact resistance at lowest loads, low tendency to cold welding
- dry-circuit switching (switching without current/voltage), recommended range of application 1 V...60 V, 1 mA...100 mA

Definitions

2) Contact materials:

Fine-grain silver AgNi0,15 / AgNi0.15 gold flashed

- relatively low contact resistance, low resistance against aggressive atmosphere
- universally applicable in medium and low load range, especially in DC-circuits, $\geq 12\text{ V}$, 10 mA

Silver-Nickel AgNi90/10

- high resistance against electrical wear, low welding tendency, higher contact resistance than AgNi0,15
- circuits with medium to high loads, DC- and AC-circuits, range of application $\geq 12\text{ V}$, 10 mA

Silver-Cadmium-Oxide AgCdO

- low welding tendency, high wear resistivity
- particularly suited for switching of inductive loads, AC-circuits, $\geq 12\text{ V}$, 100 mA

Silver-Tin-Oxide AgSnO₂

- low welding tendency, very high wear resistivity with heavy loads, low material transfer
- circuits with high requirements to make- and break currents, DC- and AC loads, $\geq 12\text{ V}$, 100 mA

Tungsten W

- highest melting point, high wear resistivity, for high switching rates and low ON-time
- as pre-contact in circuits with highest make- and break loads, $\geq 60\text{ V}$, 1 A

Contact resistance

Electrical resistance between the relay terminals of a closed contact, measured with indicated measuring current and voltage. The specified contact resistance is reached reliably only above a particular load. Considerably increased contact resistances can occur with smaller loads.

According to IEC 61810-7 the following measurement parameters based on the actual switching load are applied:

Contact type

See
- single contact

Category	Load		Measurement	
	V	A	V	A
cat. 0	0.03	0.01	0.03	0.01
cat. 1	0.03...60	0.01...0.1	0.1	0.01
cat. 2	5...250	0.1...1	24	0.1
cat. 3	5...600	0.1...100	24	1.0

- twin contact
- bridging contact
- forcibly guided contacts

Creepage distance

Shortest distance on the surface of an insulating material between two conductive elements.

C/O contact

See > changeover contact

Dielectric strength / dielectric test voltage

Voltage (rms value in AC voltage, 50Hz 1min) the insulation can withstand between relay elements that are insulated from one another.

Dust-proof relay

Relay with a case to protect against dust penetration.

Duty cycle

Ratio of the duration of energization to the total period of intermittent duty.

Drawings, Dimensions

Unless otherwise stated (see symbol below) technical drawings for product dimensions are using ISO Method E projection (European projection) according to ISO / R 128.

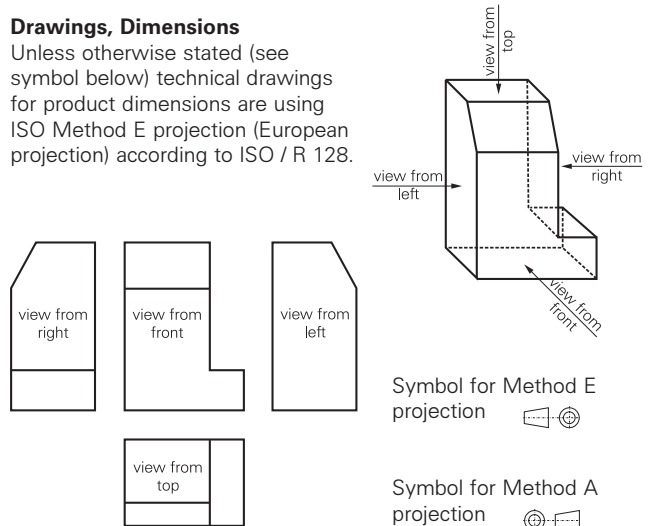

Electrical endurance/contact endurance/electrical life

Number of switching operations of a relay with electrical contact load defined under specified conditions without contact fault. The reference values specified for the endurance apply, unless otherwise specified, to a resistive load. The electrical endurance is reduced with an inductive ac load as a function of the power factor $\cos\varphi$ (φ is the phase angle between the voltage and current. See reduction factor diagram.

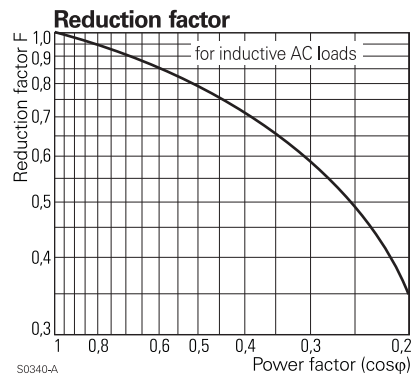

Electrical life

See > Electrical endurance

Definitions

Flammability according to UL

Data of the flammability class according to the UL 94 (Underwriters Laboratories, Inc., USA) specification. This test for technical plastic is widespread. According to the burning characteristics 4 incendiary classes are classified: UL 94 HB, V-2, V-1, V-0.

flux proof/suitable for processing on soldering lines

See 'Category of protection (IEC 61810) - RT II
Relays for processing on soldering lines; a suitable sealing of the relay on the printed circuit board side prevents any flux entering the case.

Forcibly guided contacts

Contact configuration in which break and make contacts within the complete spring set are never closed at the same time even in case of malfunction as a result of contact welding. These relays are implemented in the control of safety technology for the protection against damage to persons or objects.

Immersion cleanable / wash tight

See 'Category of protection (IEC 61810) - RT III
Relays that can be cleaned, lacquered or cast-in together with the printed circuit board after soldering. The washing requires a suitable solvent.
The term "immersion cleanable / wash tight" is not identical with "hermetically sealed"!

Insulation according to IEC 60 664

Data for insulation co-ordination on:
- rated voltage (the voltage value above which the creepage distance is measured)
- pollution degree (classification of the pollution from external materials that affect the insulation)
- overvoltage category (classification of electrical equipment (here: relays) to the overvoltage to be expected)

Insulation according to VDE0110b (2/79)

Data for insulation co-ordination on:
- insulation category (classification of equipment according to environment and utilization conditions)
- reference voltage

Insulation resistance

Electrical resistance (initial condition) measured by applying a DC voltage of 500 V between two elements of a relay that are insulated from one another.

Limiting continuous current / continuous thermal load

The highest value of the current (effective value for alternating current) that the previously closed output circuit can permanently carry under specified conditions.

Make contact

A contact that is open in the rest state and closed in the operating state.

Make current / max. make current

The current a relay can switch on closing contacts under specified conditions. Unless otherwise stated the data refers to the current for a duration of max. 4s with a duty cycle of 10%.

Max. DC load breaking capacity / Load limit curve

Switching of loads at switching voltage and switching current below the load limit curve can be switched off reliably, i.e. the arc is extinguished (max. arc duration 10 ms at resistive load). The load limit curve is affected in both position and shape by the contact materials and relay construction (contact distance, break speed of the contacts, etc.). No statement on the electrical endurance is connected with these curves.

Maximum breaking voltage DC / AC

Maximum voltage that may occur between the switching contacts before closing or after opening the contact. (DC refers to direct current; AC refers to alternating current)
Data given for AC refer to a grounded 3-phase supply with 230 / 400 Vac.

Maximum voltage U_2 (coil).

The highest permissible input voltage at the reference temperature at which the relay, with continuous energization, heats up to its max. permissible coil temperature.

Mechanical endurance

Number of switching operations without contact load during which the relay remains within the specified characteristics.

Minimum switching power

Product of the switching current and switching voltage for reliable switching. Low contact resistance is reached reliably only above a particular load. Considerably increased contact resistances can occur with smaller loads.

Monostable relays, switching characteristics

A relay is called monostable when its contacts return automatically to the rest position after the input voltage is disconnected.

Monostable, neutral relay, non-polarized relay

A neutral, monostable relay operates independently of the direction of the energizing direct current.

Monostable, polarized relay

A polarized, monostable relay only operates in a specific direction of energization. It then adopts the operating state.

Mounting position

Normally the relay can be mounted in any position if no restricting specifications are given.

Nominal power

Power consumption of the coil at nominal voltage and nominal coil resistance.

Nominal voltage (coil), Rated coil voltage

Nominal voltage at which the relay displays the operating characteristics.

Non-release voltage

The value of the input voltage at which a monostable relay does not release.

N/C contact

See > break contact

N/O contact

See > make contact

Definitions

Operate

Process in which a relay shifts from the rest state to the operating state.

Operate category

According to IEC 61810.

Operate power

Coil power at which the relay operates.

Operate time

The time interval that elapses from energizing a relay in the rest state with the nominal voltage (pulse or square signal) to the moment when the last output circuit is closed or opened (bounce time not included).

Operate voltage/Minimum voltage U_1 , preenergized

The lowest permissible input voltage at which the relay operates reliably at the reference temperature even after continuous energization (preenergizing) and brief de-energizing.

Operate voltage / Minimum voltage U_0 , without preenergizing

Minimum permissible voltage at the winding at which the relay operates, for a coil temperature of the reference temperature (20°C coil temperature without preenergizing).

Operation

Single activation and release of a relay.

Packaging unit

Minimum delivery quantity (e.g. plastic bar) and quantity per box.

Plug-in relays

Relays that are held in the socket by flat plug-in terminals (round pins for MT) where electrical contact is established simultaneously.

Print relays

Relays designed for soldering into printed circuits.

Protection category / sealing

For definition of relay protection see 'Category of protection (IEC 61810) - Relay Technology Categories

Rated coil voltage

Nominal voltage at which the relay displays the operating characteristics.

Rated current (contacts)

Current a relay can switch on and off under specified conditions.

Rated voltage (contacts)

Voltage between the switching contacts before closing or after opening of the contact. (DC refers to direct current; AC refers to alternating current)

Rated voltage (insulation)

The reference voltage for the measurement of the creepage distance according to IEC 60 664-1 and VDE0110b.

Relay cycles (dynamic response)

Due to the self induction of the coil and the inertia of the parts to be moved, on activating a relay the operations do not take place suddenly. The function diagram below shows the different cycles for the most important relay configurations of undelayed power relays. The cycles specified apply to energizing with nominal voltage (without any components in series or parallel to the coil) and at the reference temperature.

- operate time
- release time/reset time
- bounce time
- transit time
- minimum energization time

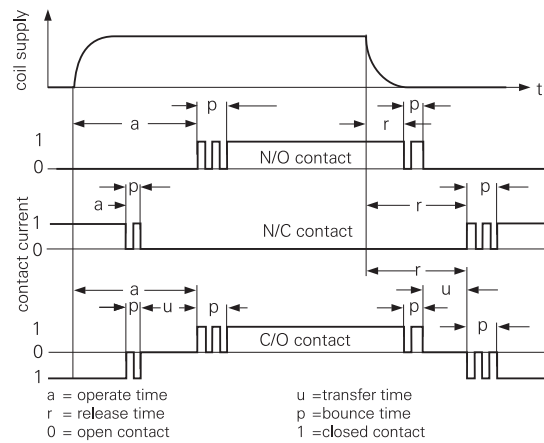

Relay Technology Categories

The 'Relay Technology Categories' describe the degree of sealing of the relay case or its contact unit. See 'Categories of protection'

Release

Process in which a monostable relay shifts from the operating state back to the rest state.

Release time

The time interval (typ.) that elapses from the point of time at which a monostable relay in the operating state has the nominal voltage disconnected to the point of time at which the last output circuit has closed or opened (not including the bounce time). The indicated times are valid for energization with nominal voltage (without any components in series or parallel to the coil) and at reference temperature.

Release voltage

The input voltage at which a monostable relay returns to the rest state at the reference temperature.

Reset

Process in which a bistable relay returns from the operating state back to the rest state.

Definitions

Reset time

The time interval (typ.) that elapses from the point of time at which a bistable relay in the operating state has the nominal voltage applied in the opposite direction to the point of time at which the last output circuit has closed or opened (not including the bounce time).

Reset voltage

The lowest input voltage at which a bistable relay shifts from the operating state into the rest state at the reference temperature.

Rest state

Switch position of a monostable relay in the unenergized state. In bistable relays this is the switch position specified by the manufacturer. The contact position is not defined at delivery.

Safety relays

The compliance with regulations for the safety of persons and material is imperative in our technical world. National and international regulations take various risks into account. These safety standards also make demands on components which share with their function the safety level of a plant, machine or the equipment. For safety relays the demand for forcibly guided contact system according ZH1/457, issued by the professional association applies; the contacts have to be linked mechanically in a way, that N/O and N/C contacts may not be closed at the same time. It has to be ensured that over the entire life and even in case of malfunction (e.g. contact welding) the contact gap will be at least 0.5mm. If specified they also comply with the wider requirements according to prEN 50205 "relays with forcibly guided contacts"

Shock resistance (destruction)

This test is used to evaluate the resistance of the relay to mechanical shocks such as those that could occur in transport or during operation (no permanent damage to the relay). This test is performed according to the IEC 68-2-27, Ea test.

Shock resistance (function)

This test is used to evaluate the resistance of the relay to mechanical shocks such as those that could occur in transport or during operation (no opening of closed relay contacts or closing of open relay contacts with a duration $>10 \mu\text{s}$ is allowed to occur during the test). This test is performed according to the IEC 68-2-27, Ea test.

Single contact

Contact system with one contact piece per contact spring.

Surge voltage / test surge voltage

Amplitude of a voltage impulse of short duration with a specified impulse form and polarity that is applied to test insulation paths in the relay.

Switching current

Current a relay can switch on and off under specified conditions.

Switching power

Product of the switching current and switching voltage (in W for direct current, in VA for alternating current).

Switching rate

Number of operations per unit of time.

Switching voltage

Voltage between the switching contacts before closing or after opening of the contact. (DC refers to direct current; AC refers to alternating current)

Tracking resistance

Evaluation of insulating materials by determining their creepage distance formation, specified by the so-called comparative number of creepage formation (CTI) according to IEC 112.

Twin contact

A compound contact consisting of two simultaneously operating make contacts with a common contact spring. Twin contacts increase the contact reliability considerably, especially when switching low currents and voltages (dry circuits).

Vibration resistance (function)

This test is used to evaluate the resistance of the relay to harmonic mechanical oscillations such as those that could occur in transport or during operation (no opening of closed relay contacts or closing of open relay contacts with a duration $>10 \mu\text{s}$ is allowed to occur during the test). This test is performed according to the IEC 68-2-6, Fc test.

Processing

Mounting

Unless otherwise stated the relay can be mounted in any position. The relays can be further processed in all of the usual commercial soldering and cleaning plants.

Insertion

No pressure should be exerted on the terminal pins after the relay has been inserted in the printed circuit board. After insertion in the printed circuit board, the terminal pins should not be bent in order to fix them. Bending the terminal pins in relays sealed against washing can damage the sealing and could alter the relay parameters. However, if fixing must be carried out before soldering, use a pressure plate or similar.

Fluxing

The fluxing process should be set up so that the flux wets only the underside of the printed circuit board. The flux should only be visible as foam flux through any open perforations in the printed circuit board. If the printed circuit board is flooded by foam flux, bursting flux bubbles can lead to contamination in open relays and, consequently, to failures. To protect against corrosion, no acidiferous flux should be used. The recommended flux types are 1.1.3, 1.2.3 or 2.2.3 according to DIN EN 29454 T.1.

Preheating

In the normal preheating of flux, the temperature of the upper surface of the printed circuit board should not exceed 100°C. Ensure that any not completely dry flux exploding on being submerged in the solder wave does not penetrate the insides of open relays.

Soldering

PIN version

The relays in the PIN version are soldered according to the S-Sn60Pb40 or S-Sn63Pb37 solder types in accordance with DIN EN 29453. The solder bath temperature should be max. 260°C with a solder duration of approx. 3 s.

SMD version

The soldering processes approved for relays of the SMD version are condensation soldering (vapour phase), infrared soldering (radiation and/or convection) and full wave soldering.

Approved Soldering Techniques	Max. sold. duration	Max. sold. temp.
Condensation soldering (vapour phase)	40 s	215°C
Infrared soldering	40 s	215°C
Full wave soldering	10 s	260°C

Refer to the recommendations of CECC 00802 for the complete soldering profile.

Manual soldering

For manual soldering, we recommend a soldering temperature of 300 to 350 °C for a maximum soldering time of 2 s. The recommended solder type is pipe solder 1 DIN 8516-LSnPb zh/F-SW 32 to 34 (1 mm , 2.5 percentage by weight flux portion).

Cooling

The thermal loading resulting from the soldering process can be reduced at the end of the process by cooling.

Cleaning

We recommend avoiding washing processes in order to protect the environment. The fluxes we specify render a wash process unnecessary. If cleaning is required for other reasons, the following points must be observed independently of the washing process:

- the printed circuit boards must be washed immediately after the soldering process!
- the washing process must be set up so that any accumulation of washing fluid inside the relay is avoided!
- the individual wash stations must be separate from one another to prevent cross-contamination!
- after the final washing process, the printed circuit boards must be cleaned again using a clean washing medium!
- After washing, compressed air should be used to blow off the printed circuit board to speed up the drying process.

Protective lacquering

For the protective lacquering of the mounted printed circuit boards, we recommend single-component lacquer that is applied by immersion.

The maximum drying temperature should be 70 °C.

Part number reference list

Part No	Relay	Product key	Page	Part No	Relay	Product key	Page	Part No	Relay	Product key	Page
0-1393092-1	MT	MT326115	129	0-1393216-6	Card E	V23057-B0023-A401	74	0-1393240-7	RT1 dc/ac	RT314730	37
0-1393092-2	MT	MT326230	129	0-1393216-7	Card E	V23057-B0023-B101	74	0-1393240-8	RT1 bistable	RT315F03	40
0-1393092-3	MT	MT328012	129	0-1393216-8	Card E	V23057-B0023-B601	74	0-1393240-9	RT1	RT315005	37
0-1393092-4	MT	MT328024	129	0-1393216-9	Card E	V23057-B0028-A401	74	0-1393243-1	RT2 dc/ac	RTE24005	67
0-1393092-5	MT	MT328048	129	0-1393217-1	RE	RE030005	26	0-1393243-2	RT2 dc/ac	RTE24006	67
0-1393092-7	MT	MT328115	129	0-1393217-2	RE	RE030006	26	0-1393243-3	RT2 dc/ac	RTE24009	67
0-1393092-8	MT	MT328230	129	0-1393217-3	RE	RE030009	26	0-1393243-4	RT2 dc/ac	RTE24012	67
0-1393092-9	MT	MT329115	129	0-1393217-4	RE	RE030012	26	0-1393243-6	RT2 dc/ac	RTE24018	67
0-1393097-5	RMC/RMD	RMD35730	143	0-1393217-7	RE	RE030018	26	0-1393243-7	RT2 dc/ac	RTE24020	67
0-1393146-1	RMC/RMD	RMC05012	143	0-1393217-8	RE	RE030024	26	0-1393243-8	RT2 dc/ac	RTE24022	67
0-1393146-2	RMC/RMD	RMC05048	143	0-1393219-3	PE	PE014005	22	0-1393244-2	RT2 dc/ac	RT444048	67
0-1393146-3	RMC/RMD	RMC05060	143	0-1393219-4	PE	PE014006	22	0-1393244-3	RT2 dc/ac	RT444110	67
0-1393146-4	RMC/RMD	RMC05221	143	0-1393219-5	PE	PE014009	22	0-1393244-4	RT2 dc/ac	RT444524	67
0-1393146-5	RMC/RMD	RMC05524	143	0-1393219-6	PE	PE014012	22	0-1393244-5	RT2 dc/ac	RT444615	67
0-1393146-6	RMC/RMD	RMC05730	143	0-1393219-8	PE	PE014018	22	0-1393244-7	RT2 dc/ac	RT444730	67
0-1393146-7	RMC/RMD	RMC35024	143	0-1393219-9	PE	PE014021	22	0-1393244-8	RT2 dc/ac	RT445009	67
0-1393146-8	RMC/RMD	RMD05012	143	0-1393222-1	MSR	V23061-A1001-A202	34	0-1393244-9	RT2 dc/ac	RT445024	67
0-1393146-9	RMC/RMD	RMD05024	143	0-1393222-2	MSR	V23061-A1001-A302	34	0-1393249-7	W58	W58-XB1A4A-10	169
0-1393147-1	RM 2/3/7	RM707524	132	0-1393222-3	MSR	V23061-A1002-A202	34	0-1393249-8	W58	W58-XB1A4A-12	169
0-1393147-2	RM 2/3/7	RM707730	132	0-1393222-4	MSR	V23061-A1002-A302	34	0-1393249-9	W58	W58-XB1A4A-15	169
0-1393147-3	RM 2/3/7	RM7080C4	132	0-1393222-5	MSR	V23061-A1002-A402	34	0-1393250-3	W28	W28-SQ1A-15	167
0-1393147-4	RM 2/3/7	RM708024	132	0-1393222-6	MSR	V23061-A1002-A502	34	0-1393250-8	W28	W28-SQ11A-15	167
0-1393147-5	RM 2/3/7	RM709730	132	0-1393222-9	MSR	V23061-A1003-A302	34	0-1393258-2	SR2 M	V23047-A1005-A501	102
0-1393147-6	RM 2/3/7	RM732L2C4	132	0-1393224-1	RY II	RYA30005	31	0-1393258-3	SR2 M	V23047-A1009-A501	102
0-1393147-7	RM 2/3/7	RM732L48	132	0-1393224-2	RY II	RYA30006	31	0-1393258-4	SR2 M	V23047-A1012-A501	102
0-1393147-8	RM 2/3/7	RM7320C4	132	0-1393224-3	RY II	RYA30009	31	0-1393258-5	SR2 M	V23047-A1012-A511	102
0-1393147-9	RM 2/3/7	RM732060	132	0-1393224-4	RY II	RYA30012	31	0-1393258-8	SR2 M	V23047-A1018-A501	102
0-1393149-2	RM 5/6	RM632L2C4	136	0-1393224-5	RY II	RYA30019	31	0-1393258-9	SR2 M	V23047-A1018-A511	102
0-1393149-4	RM 5/6	RM632221	136	0-1393224-6	RY II	RYA30024	31	0-1393260-1	SR6	V23050-A1005-A542	110
0-1393149-7	RM 5/6	RM632730	136	0-1393224-7	RY II	RYA31005	31	0-1393260-2	SR6	V23050-A1006-A542	110
0-1393149-9	RM 5/6	RM637024	136	0-1393224-8	RY II	RYA31006	31	0-1393260-3	SR6	V23050-A1009-A542	110
0-1393154-1	PT	PT230024	123	0-1393224-9	RY II	RYA31012	31	0-1393260-4	SR6	V23050-A1012-A542	110
0-1393154-2	PT	PT270512	123	0-1393225-1	RY II	RY551018	31	0-1393260-5	SR6	V23050-A1012-A542	110
0-1393154-3	PT	PT280024	123	0-1393225-2	RY II	RY551024	31	0-1393260-6	SR6	V23050-A1021-A542	110
0-1393154-4	PT	PT280524	123	0-1393225-3	RY II	RY552012	31	0-1393260-7	SR6	V23050-A1024-A542	110
0-1393154-5	PT	PT280730	123	0-1393225-4	RY II	RY553009	31	0-1393260-8	SR6	V23050-A1036-A542	110
0-1393154-6	PT	PT281730	123	0-1393225-5	RY II	RY553012	31	0-1393260-9	SR6	V23050-A1040-A542	110
0-1393154-7	PT	PT370006	123	0-1393225-6	RY II	RY553024	31	0-1393844-1	RM 5/6	RM507024	136
0-1393154-8	PT	PT371615	123	0-1393225-7	RY II	RY610005	31	0-1393844-2	RM 5/6	RM509L24	136
0-1393154-9	PT	PT380024	123	0-1393225-8	RY II	RY610006	31	0-1393844-3	RM 5/6	RM602012	136
0-1393161-2	Acc. RP,RT	RPME10L0	150	0-1393225-9	RY II	RY610009	31	0-1393844-4	RM 5/6	RM602024	136
0-1393161-3	Acc. RP,RT	RPMG0024	150	0-1393230-1	RP3SL	RP3SLA05	55	0-1393844-6	RM 5/6	RM607024	136
0-1393161-4	Acc. RP,RT	RPML0024	150	0-1393230-2	RP3SL	RP3SLA06	55	0-1393844-7	RM 2/3/7	RM702012	132
0-1393161-5	Acc. RP,RT	RPML0048	150	0-1393230-3	RP3SL	RP3SLA12	55	0-1393844-8	RM 2/3/7	RM702048	132
0-1393161-6	Acc. RP,RT	RPML0110	150	0-1393230-4	RP3SL	RP3SLA21	55	0-1393844-9	RM 2/3/7	RM702524	132
0-1393161-7	Acc. RP,RT	RPML0524	150	0-1393230-5	RP3SL	RP3SLF12	55	0-1393845-1	RP II/2	RP820F12	72
0-1393161-8	Acc. RP,RT	RPML0730	150	0-1393230-6	RP3SL	RP3SLF24	55	0-1393845-2	RP II/2	RP820F48	72
0-1393162-1	Acc. PT	PT28802	154	0-1393230-7	RP3SL	RP3SL005	55	0-1393845-3	RP II/2	RP821006	72
0-1393162-5	Acc. PT	PT78603	154	0-1393230-8	RP3SL	RP3SL006	55	0-1393845-4	RP II/2	RP821012	72
0-1393162-7	Acc. PT	RA78728	154	0-1393230-9	RP3SL	RP3SL012	55	0-1393845-5	RP II/2	RP821024	72
0-1393164-1	Acc. PCLH	TM28800	161	0-1393231-1	RP II/1	RP411615	52	0-1393845-6	RP II/2	RP821048	72
0-1393164-2	Acc. PCLH	TM78700	161	0-1393231-2	RP II/1	RP411730	52	0-1393845-7	RP II/2	RP821060	72
0-1393186-3	T7N/T7N-VWG	T7N51D1-06	84	0-1393231-3	RP II/1	RP412A48	52	0-1393845-8	RP II/2	RP821524	72
0-1393199-1	IF	V23077-A1001-A402	61	0-1393231-4	RP II/1	RP412A60	52	0-1393845-9	RP II/2	RP821615	72
0-1393199-2	IF	V23077-A1002-A402	61	0-1393231-5	RP II/1	RP412F05	52	0-1415002-1	PT	PT270R24	123
0-1393199-3	IF	V23077-A1002-A403	61	0-1393231-6	RP II/1	RP412F12	52	0-1415006-1	PT	PT520L24	123
0-1393199-4	IF	V23077-A1003-A402	61	0-1393231-7	RP II/1	RP412F24	52	0-1415008-1	RM 5/6	RM507730	136
0-1393199-6	IF	V23077-A1004-A402	61	0-1393231-8	RP II/1	RP412005	52	0-1415009-1	RMC/RMD	RMD05615	143
0-1393199-7	IF	V23077-A1005-A402	61	0-1393231-9	RP II/1	RP412006	52	0-1415012-1	SR2 M	V23047-A1060-A501	102
0-1393199-9	IF	V23077-A1005-A403	61	0-1393232-1	RP II/1	RP811524	52	0-1415013-1	MT	MT228012	129
0-1393203-1	U/UB	V23148-A0002-A101	77	0-1393232-2	RP II/1	RP811615	52	0-1415015-1	SR6	V23050-A1024-A533	110
0-1393203-2	U/UB	V23148-A0002-B101	77	0-1393232-3	RP II/1	RP811730	52	0-1415017-1	SR6	V23050-A1024-A551	110
0-1393203-3	U/UB	V23148-A0002-C101	77	0-1393232-4	RP II/1	RP812F05	52	0-1415018-1	SR6	V23050-A1009-A533	110
0-1393203-4	U/UB	V23148-A0003-A101	77	0-1393232-5	RP II/1	RP812F24	52	0-1415019-1	SR6	V23050-A1036-A551	110
0-1393203-5	U/UB	V23148-A0003-B101	77	0-1393232-6	RP II/1	RP812005	52	0-1415025-1	Acc. SNR	ST16040	147
0-1393203-6	U/UB	V23148-A0003-C101	77	0-1393232-7	RP II/1	RP812009	52	0-1415026-1	PT	PT280R24	123
0-1393203-7	U/UB	V23148-A0004-A101	77	0-1393232-8	RP II/1	RP812012	52	0-1415029-1	RT1 inrush	RT31KA12	44
0-1393203-8	U/UB	V23148-A0005-A101	77	0-1393232-9	RP II/1	RP812024	52	0-1415030-1	PB	PB134005	82
0-1393203-9	U/UB	V23148-A0005-B101	77	0-1393234-2	RP II/1	RP81A615	52	0-1415031-1	PB	PB334012	82
0-1393204-1	U/UB	V23148-B0001-A101	77	0-1393234-5	RP II/1	RP810006	52	0-1415034-1	MT	MT325110	129
0-1393204-2	U/UB	V23148-B0002-A101	77	0-1393235-2	RP II/2	RP42A024	72	0-1415035-1	Acc. MT	MT78750	158
0-1393204-3	U/UB	V23148-B0002-B101	77	0-1393235-3	RP II/2	RP42A048	72	0-1415037-1	A. PT,RP,RT	PTMT00L0	150
0-1393204-4	U/UB	V23148-B0003-A101	77	0-1393235-4	RP II/2	RP42A060	72	0-1415038-1	Acc. PT	PT17020	154
0-1393204-5	U/UB	V23148-B0003-B101	77	0-1393235-5	RP II/2	RP42A080	72	0-1415039-1	RTH	RTH34024	50
0-1393204-6	U/UB	V23148-B0003-C101	77	0-1393235-6	RP II/2	RP42A110	72	0-1415040-1	A. PT,RP,RT	PTMT00T0	150
0-1393204-7	U/UB	V23148-B0005-A101	77	0-1393235-7	RP II/2	RP42A730	72	0-1415041-1	SR6	SR6F4110	110
0-1393204-8	U/UB	V23148-B0005-B101	77	0-1393235-8	RP II/2	RP42C020	72	0-1415044-1	Acc. MT	MT78603	158
0-1393204-9	U/UB	V23148-B0005-C101	77	0-1393235-9	RP II/2	RP42C024	72	0-1415048-1	PT	PT270R48	123
0-1393210-2	T9A	T9AN1D12-24	87	0-1393236-1	SNR	V23092-A1005-A201	28	0-1415054-1	SR4 D/M	SR4M4021	105
0-1393212-2	T92	T92S7A22-120	90	0-1393236-2	SNR	V23092-A1005-A301	28	0-1415055-1	SR4 D/M	SR4D4012	105
0-1393212-4	T92	T92S7A22-24	90	0-1393236-3	SNR	V23092-A1006-A301	28	0-1415056-1	SR6sensitive	SR6B4S05	113
0-1393212-5	T92	T92S7A22-240	90	0-1393236-4	SNR	V23092-A1012-A201	28	0-1415057-1	SR6sensitive	SR6A4S05	113
0-1393212-7	T92	T92S7D12-110	90	0-1393236-5	SNR	V23092-A1012-A202	28	0-1415058-1	SR6sensitive	SR6C4S05	113
0-1393212-8	T92	T92S7D12-12	90	0-1393236-6	SNR	V23092-A1012-A203	28	0-1415060-1	SR6 Z	SR6Z4615	116
0-1393215-1	Card E	V23057-A0001-A101	74	0-1393236-7	SNR	V23092-A1012-A301	28	0-1415062-1	SR6 D/M	SR6D4110	108
0-1393215-2	Card E	V23057-A0001-A201	74	0-1393236-8	SNR	V23092-A1012-A302	28	0-1415064-1	PE	PE014C24	22
0-1393215-3	Card E	V23057-A0001-A401	74	0-1393236-9	SNR	V23092-A1012-A303	28				

Part number reference list

Part No	Relay	Product key	Page	Part No	Relay	Product key	Page	Part No	Relay	Product key	Page
0-1415403-9	409 dc	0409 47 008 000	58	1-1393154-2	PT	PT570024	123	1-1393225-0	RY II	RY610012	31
0-1415404-1	430 1/2pole	0430 17 0916 00	96	1-1393154-3	PT	PT570125	123	1-1393225-1	RY II	RY610015	31
0-1415404-2	430 1/2pole	0430 17 0916 03	96	1-1393154-4	PT	PT571252	123	1-1393225-2	RY II	RY610018	31
0-1415404-3	430 1/2pole	0430 17 1006 00	96	1-1393154-5	PT	PT571615	123	1-1393225-3	RY II	RY610021	31
0-1415404-4	430 1/2pole	0430 17 1016 00	96	1-1393154-6	PT	PT580012	123	1-1393225-4	RY II	RY610024	31
0-1415404-5	430 1/2pole	0430 17 6506 04	96	1-1393154-7	PT	PT580024	123	1-1393225-5	RY II	RY610048	31
0-1415404-6	430 1/2pole	0430 17 6606 04	96	1-1393154-8	PT	PT580048	123	1-1393225-6	RY II	RY610060	31
0-1415404-7	430 1/2pole	0430 17 6706 05	96	1-1393154-9	PT	PT580060	123	1-1393225-7	RY II	RY611005	31
0-1415404-8	430 1/2pole	0430 17 7306 10	96	1-1393161-1	Acc. RP,RT	RPMT00A0	150	1-1393225-8	RY II	RY611006	31
0-1415404-9	430 1/2pole	0430 17 9216 01	96	1-1393161-3	Acc. RP,RT	RPMU0548	150	1-1393225-9	RY II	RY611012	31
0-1415405-0	409 bistable	0409 67 032 001	58	1-1393161-4	Acc. RP,RT	RPMU0730	150	1-1393230-0	RP3SL	RP3SL018	55
0-1415405-1	409 bistable	0409 67 029 001	58	1-1393161-7	Acc. RP	RP16100	150	1-1393230-1	RP3SL	RP3SL024	55
0-1415410-1	410 125°C	0410 63 001 000	63	1-1393161-8	Acc. RP	RP16104	150	1-1393230-2	RP3SL	RP3SL048	55
0-1415410-2	410 125°C	0410 63 003 000	63	1-1393161-9	Acc. RP	RP28500	150	1-1393230-3	RP3SL	RP3SL060	55
0-1415410-3	410 125°C	0410 63 004 000	63	1-1393199-2	IF	V23077-A1007-A402	61	1-1393230-4	RP3SL	RP3SL110	55
0-1415410-4	410 125°C	0410 63 008 000	63	1-1393199-3	IF	V23077-A1007-A403	61	1-1393230-5	RP II/1	RP31D024	52
0-1415410-5	410 125°C	0410 63 009 000	63	1-1393199-5	IF	V23077-A1009-A402	61	1-1393230-6	RP II/1	RP310A06	52
0-1415410-6	410 125°C	0410 63 010 000	63	1-1393199-6	IF	V23077-A1009-A403	61	1-1393230-7	RP II/1	RP310A12	52
0-1415410-7	410 125°C	0410 63 011 000	63	1-1393199-7	IF	V23077-A1012-A402	61	1-1393230-8	RP II/1	RP310A60	52
0-1415410-8	410 125°C	0410 63 012 000	63	1-1393203-0	U/UB	V23148-A0005-C101	77	1-1393230-9	RP II/1	RP310F05	52
0-1415410-9	410 125°C	0410 63 013 001	63	1-1393203-1	U/UB	V23148-A0007-A101	77	1-1393231-0	RP II/1	RP412010	52
0-1415419-1	419	0419 01 0305 03	99	1-1393203-2	U/UB	V23148-A0007-B101	77	1-1393231-1	RP II/1	RP412012	52
0-1415419-2	419	0419 01 0701 02	99	1-1393203-3	U/UB	V23148-A0007-C101	77	1-1393231-2	RP II/1	RP412024	52
0-1415419-3	419	0419 01 0701 06	99	1-1393203-4	U/UB	V23148-A0008-A101	77	1-1393231-3	RP II/1	RP412048	52
0-1415419-4	419	0419 01 0701 09	99	1-1393203-5	U/UB	V23148-A0102-A101	77	1-1393231-4	RP II/1	RP412060	52
0-1415419-5	419	0419 01 0901 00	99	1-1393203-6	U/UB	V23148-A0102-B101	77	1-1393231-5	RP II/1	RP412110	52
0-1415419-6	419	0419 01 0901 01	99	1-1393203-7	U/UB	V23148-A0102-C101	77	1-1393231-6	RP II/1	RP412524	52
0-1415419-7	419	0419 01 1001 00	99	1-1393203-8	U/UB	V23148-A0103-A101	77	1-1393231-7	RP II/1	RP412615	52
0-1415419-8	419	0419 01 1001 01	99	1-1393203-9	U/UB	V23148-A0103-B101	77	1-1393231-8	RP II/1	RP412730	52
0-1415419-9	419	0419 01 1001 02	99	1-1393204-0	U/UB	V23148-B0007-A101	77	1-1393231-9	RP II/1	RP418A12	52
0-1415430-1	430 3mm	0430 04 0911 00	93	1-1393204-1	U/UB	V23148-B0007-B101	77	1-1393232-0	RP II/1	RP812110	52
0-1415430-2	430 3mm	0430 04 0911 01	93	1-1393204-2	U/UB	V23148-B0007-C101	77	1-1393232-1	RP II/1	RP812615	52
0-1415430-3	430 3mm	0430 04 1011 00	93	1-1393204-3	U/UB	V23148-B0008-A101	77	1-1393232-2	RP II/1	RP812730	52
0-1415430-4	430 3mm	0430 04 1311 00	93	1-1393204-4	U/UB	V23148-B0010-A101	77	1-1393232-3	RP II/1	RP818A05	52
0-1415430-5	430 3mm	0430 05 0901 00	93	1-1393210-2	T9A	T9AS1D12-110	87	1-1393232-4	RP II/1	RP818F24	52
0-1415430-6	430 3mm	0430 05 0911 00	93	1-1393210-3	T9A	T9AS1D12-12	87	1-1393232-5	RP II/1	RP818005	52
0-1415430-7	430 3mm	0430 05 1001 00	93	1-1393210-4	T9A	T9AS1D12-15	87	1-1393232-6	RP II/1	RP818006	52
0-1415430-8	430 3mm	0430 05 1011 00	93	1-1393210-5	T9A	T9AS1D12-18	87	1-1393232-7	RP II/1	RP818012	52
0-1415430-9	430 3mm	0430 05 1021 00	93	1-1393210-8	T9A	T9AS1D12-24	87	1-1393232-8	RP II/1	RP818018	52
0-1419105-2	RM 2/3/7	RM703627	132	1-1393210-9	T9A	T9AS1D12-48	87	1-1393232-9	RP II/1	RP818024	52
0-1419108-1	RT1 dc/ac	RT114012	37	1-1393212-0	T92	T92S7D12-24	90	1-1393234-3	RP II/1	RP818A12	52
0-1419108-6	RT1 dc/ac	RT124730	37	1-1393212-1	T92	T92S7D12-48	90	1-1393234-5	RP II/1	RP818F12	52
0-1419108-7	Acc. RT	RT28516	150	1-1393212-3	T92	T92S7D22-110	90	1-1393234-6	RP II/1	RP818524	52
0-1419112-1	Acc. PT	PT78703	154	1-1393212-7	T92	T92S7D22-24	90	1-1393234-7	RP II/1	RP818615	52
0-1419112-2	Acc. PT	PT78704	154	1-1393215-0	Card E	V23057-A0002-A901	74	1-1393235-0	RP II/2	RP42C060	72
0-1419118-5	Acc. RM	RM28802	162	1-1393215-1	Card E	V23057-A0002-B101	74	1-1393235-1	RP II/2	RP420F05	72
0-1419118-6	Acc. RM	RM78700	162	1-1393215-2	Card E	V23057-A0002-B601	74	1-1393235-2	RP II/2	RP420F48	72
0-1419136-6	RM 2/3/7	RM205048	132	1-1393215-4	Card E	V23057-A0004-A401	74	1-1393235-4	RP II/2	RP420004	72
0-1419136-7	RM 5/6	RM502900	136	1-1393215-5	Card E	V23057-A0005-A401	74	1-1393235-5	RP II/2	RP420018	72
0-1419136-8	RM 5/6	RM505740	136	1-1393215-6	Card E	V23057-A0005-A402	74	1-1393235-6	RP II/2	RP420034	72
0-1419136-9	RM 2/3/7	RM705110	132	1-1393215-7	Card E	V23057-A0005-A901	74	1-1393235-7	RP II/2	RP420036	72
0-1419143-2	RP II/1	RP459012	52	1-1393215-9	Card E	V23057-A0005-A902	74	1-1393235-8	RP II/2	RP420080	72
0-1419143-3	RP II/1	RP45B024	52	1-1393216-0	Card E	V23057-B0028-B101	74	1-1393235-9	RP II/2	RP421A12	72
0-1419144-8	RT2 dc/ac	RT444005	67	1-1393216-1	Card E	V23057-B0028-B601	74	1-1393236-3	SNR	V23092-A1012-A801	28
0-1419146-7	PCD	PCD-148-D1MH	80	1-1393216-2	Card E	V23057-B0030-A401	74	1-1393236-8	SNR	V23092-A1018-A201	28
0-1419151-2	RP II/2	RP421548	72	1-1393216-5	Card E	V23057-B1006-A401	74	1-1393236-9	SNR	V23092-A1018-A301	28
0-1419151-4	RP II/2	RP421F48	72	1-1393217-0	RE	RE030036	26	1-1393238-1	RT1 dc/ac	RTB14003	37
0-1419151-9	RP II/2	RP427A12	72	1-1393217-1	RE	RE030048	26	1-1393238-2	RT1 dc/ac	RTB14005	37
1-1393092-1	MT	MT331024	129	1-1393217-2	RE	RE031003	26	1-1393238-3	RT1 dc/ac	RTB14006	37
1-1393092-2	MT	MT331048	129	1-1393217-3	RE	RE031006	26	1-1393238-4	RT1 dc/ac	RTB14009	37
1-1393092-3	MT	MT331110	129	1-1393217-4	RE	RE031009	26	1-1393238-5	RT1 dc/ac	RTB14012	37
1-1393092-5	MT	MT331220	129	1-1393217-5	RE	RE031012	26	1-1393238-6	RT1 dc/ac	RTB14015	37
1-1393092-6	MT	MT3330C4	129	1-1393217-6	RE	RE031018	26	1-1393238-7	RT1 dc/ac	RTB14018	37
1-1393092-8	MT	MT333024	129	1-1393217-7	RE	RE031021	26	1-1393238-8	RT1 dc/ac	RTB14020	37
1-1393092-9	MT	MT3331B0	129	1-1393217-8	RE	RE031024	26	1-1393238-9	RT1 dc/ac	RTB14024	37
1-1393107-5	RM 2/3/7	RM202L48	132	1-1393217-9	RE	RE032005	26	1-1393239-1	RT1 dc/ac	RT114018	37
1-1393107-6	RM 2/3/7	RM202M10	132	1-1393219-0	PE	PE014024	22	1-1393239-2	RT1 dc/ac	RT114020	37
1-1393107-7	RM 2/3/7	RM202006	132	1-1393219-2	PE	PE014036	22	1-1393239-3	RT1 dc/ac	RT114024	37
1-1393146-0	RMC/RMD	RMD05048	143	1-1393219-3	PE	PE014048	22	1-1393239-4	RT1 dc/ac	RT114048	37
1-1393146-1	RMC/RMD	RMD05524	143	1-1393219-4	PE	PE015012	22	1-1393239-5	RT1 dc/ac	RT114060	37
1-1393146-5	RM 2/3/7	RM202110	132	1-1393219-5	PE	PE015024	22	1-1393239-6	RT1 dc/ac	RT114110	37
1-1393146-6	RM 2/3/7	RM202221	132	1-1393219-6	PE	PE015048	22	1-1393239-7	RT1 dc/ac	RT114524	37
1-1393146-7	RM 2/3/7	RM202506	132	1-1393219-7	PE	PE514005	22	1-1393239-8	RT1 dc/ac	RT114615	37
1-1393146-8	RM 2/3/7	RM202512	132	1-1393219-8	PE	PE514006	22	1-1393239-9	RT1 dc/ac	RT114730	37
1-1393146-9	RM 2/3/7	RM202524	132	1-1393219-9	PE	PE514009	22	1-1393240-0	RT1 dc/ac	RT315006	37
1-1393147-0	RM 2/3/7	RM732524	132	1-1393222-2	MSR	V23061-A1003-A402	34	1-1393240-1	RT1 dc/ac	RT315012	37
1-1393147-1	RM 2/3/7	RM732615	132	1-1393222-3	MSR	V23061-A1003-A502	34	1-1393240-2	RT1 dc/ac	RT315015	37
1-1393147-3	RM 2/3/7	RM732720	132	1-1393222-5	MSR	V23061-A1004-A302	34	1-1393240-3	RT1 dc/ac	RT315018	37
1-1393147-4	RM 2/3/7	RM732880	132	1-1393222-6	MSR	V23061-A1004-A402	34	1-1393240-4	RT1 dc/ac	RT315024	37
1-1393147-5	RM 2/3/7	RM733730	132	1-1393222-7	MSR	V23061-A1004-A502	34	1-1393240-5	RT1 dc/ac	RT315036	37
1-1393147-6	RM 2/3/7	RM733740	132	1-1393222-8	MSR	V23061-A1004-A602	34	1-1393240-6	RT1 dc/ac	RT315048	37
1-1393147-8	RM 2/3/7	RM735012	132	1-1393223-1	MSR	V23061-B1006-A301	34	1-1393240-7	RT1 dc/ac	RT315060	37
1-1393147-9	RM 2/3/7	RM735548	132	1-1393223-2	MSR	V23061-B1006-A401	34	1-1393240-8	RT1 dc/ac	RT315080	37
1-1393148-1	RM 2/3/7	RM202L24	132	1-1393223-4	MSR	V23061-B1006-A501	34	1-1393240-9	RT1 dc/ac	RT315110	37
1-1393148-2	RM 2/3/7	RM202048	132	1-1393223-5	MSR	V23061-B1006-A601	34</				

Part number reference list

Part No	Relay	Product key	Page	Part No	Relay	Product key	Page	Part No	Relay	Product key	Page
1-1393249-9	W58	W58-XB1A4A-5	169	1-1415419-9	419	0419 01 1503 08	99	2-1393217-2	RE	RE032012	26
1-1393250-9	W28	W28-XQ1A-0.25	167	1-1415430-0	430 3mm	0430 05 1111 00	93	2-1393217-3	RE	RE032018	26
1-1393252-7	W6	W67-A2Q12-10	171	1-1415430-1	430 3mm	0430 05 1301 00	93	2-1393217-4	RE	RE032024	26
1-1393252-8	W6	W67-A2Q12-5	171	1-1415430-2	430 3mm	0430 05 1311 00	93	2-1393217-5	RE	RE032048	26
1-1393258-1	SR2 M	V23047-A1021-A501	102	1-1415430-3	430 3mm	0430 05 2301 00	93	2-1393217-6	RE	RE036006	26
1-1393258-2	SR2 M	V23047-A1021-A511	102	1-1415430-4	430 3mm	0430 05 2701 00	93	2-1393217-7	RE	RE036012	26
1-1393258-5	SR2 M	V23047-A1024-A501	102	1-1415430-5	430 3mm	0430 05 2711 00	93	2-1393219-0	PE	PE514012	22
1-1393258-7	SR2 M	V23047-A1024-A511	102	1-1415430-6	430 3mm	0430 05 2711 07	93	2-1393219-1	PE	PE514018	22
1-1393260-0	SR6	V23050-A1048-A542	110	1-1415430-7	430 3mm	0430 05 2811 00	93	2-1393219-2	PE	PE514024	22
1-1393260-1	SR6	V23050-A1060-A542	110	1-1415430-8	430 3mm	0430 05 3211 01	93	2-1393219-3	PE	PE514036	22
1-1393260-2	SR6	V23050-A1085-A542	110	1-1415430-9	430 3mm	0430 05 3611 04	93	2-1393222-0	MSR	V23061-A1005-A302	34
1-1393260-3	SR6	V23050-A1110-A542	110	1-1419104-6	T9A	T9AS1D22-110	87	2-1393222-3	MSR	V23061-A1005-A402	34
1-1393844-0	RM 2/3/7	RM702615	132	1-1419104-7	T9A	T9AS1D22-12	87	2-1393222-7	MSR	V23061-A1005-A502	34
1-1393844-1	RM 2/3/7	RM702730	132	1-1419104-8	T9A	T9AS1D22-15	87	2-1393222-8	MSR	V23061-A1005-A602	34
1-1393844-2	RM 2/3/7	RM703024	132	1-1419104-9	T9A	T9AS1D22-18	87	2-1393223-1	MSR	V23061-B1007-A401	34
1-1393844-3	RM 2/3/7	RM703110	132	1-1419108-1	RT1 dc/ac	RT315730	37	2-1393223-5	MSR	V23061-B1007-A501	34
1-1393844-4	RM 2/3/7	RM705615	132	1-1419136-0	RM 2/3/7	RM708730	132	2-1393223-6	MSR	V23061-B1007-A601	34
1-1393844-5	RM 2/3/7	RM705730	132	1-1419136-1	RM 2/3/7	RM709548	132	2-1393224-0	RY II	RYA33021	31
1-1393844-7	RM 2/3/7	RM732024	132	1-1419151-0	RP II/2	RP42A524	72	2-1393224-1	RY II	RYA33024	31
1-1393844-8	RM 2/3/7	RM732730	132	1-1419151-3	RP II/1	RP430060	52	2-1393224-2	RY II	RYA33060	31
1-1393844-9	RM 2/3/7	RM737012	132	1-1419151-4	RP II/1	RP430060	52	2-1393224-3	RY II	RYA50005	31
1-1393845-0	RP II/2	RP821F12	72	1-1419151-5	RP II/1	RP430110	52	2-1393224-4	RY II	RYA50012	31
1-1393845-2	RP II/2	RP827012	72	1-1419151-6	RP II/1	RP430730	52	2-1393224-5	RY II	RYA50024	31
1-1393845-3	RP II/2	RP827024	72	1-1419151-7	RP II/1	RP430A06	52	2-1393224-6	RY II	RYA51005	31
1-1393845-4	RP II/2	RP82A024	72	1-1419151-8	RP II/1	RP430A12	52	2-1393224-7	RY II	RYA51012	31
1-1393845-5	RP II/2	RP82C012	72	1-1419151-9	RP II/1	RP438005	52	2-1393224-8	RY II	RYA51024	31
1-1393845-6	RP II/2	RP840005	72	1-1440009-6	PCLH	PCLH-208A1F	157	2-1393224-9	RY II	RYA52009	31
1-1393845-7	RP II/2	RP840012	72	2-1393092-0	MT	MT333110	129	2-1393225-0	RY II	RY611019	31
1-1393845-8	RP II/2	RP840024	72	2-1393092-2	MT	MT333220	129	2-1393225-1	RY II	RY611024	31
1-1414034-0	Card E	V23057-A0015-A102	74	2-1393092-4	MT	MT336048	129	2-1393225-2	RY II	RY611048	31
1-1415012-1	SR2 M	V23047-A1110-A501	102	2-1393092-5	MT	MT336115	129	2-1393225-3	RY II	RY612005	31
1-1415013-1	MT	MT228048	129	2-1393092-6	MT	MT336230	129	2-1393225-4	RY II	RY612006	31
1-1415014-1	MT	MT328110	129	2-1393092-7	MT	MT338024	129	2-1393225-5	RY II	RY612009	31
1-1415015-1	SR6	V23050-A1012-A533	110	2-1393092-8	MT	MT338230	129	2-1393225-6	RY II	RY612012	31
1-1415017-1	SR6	V23050-A1012-A551	110	2-1393146-0	RM 2/3/7	RM202615	132	2-1393225-7	RY II	RY612018	31
1-1415018-1	SR6	V23050-A1015-A533	110	2-1393146-1	RM 2/3/7	RM202720	132	2-1393225-8	RY II	RY612021	31
1-1415019-1	SR6	V23050-A1040-A551	110	2-1393146-2	RM 2/3/7	RM203006	132	2-1393225-9	RY II	RY612024	31
1-1415021-1	PT	PT570L48	123	2-1393146-3	RM 2/3/7	RM203110	132	2-1393230-0	RP II/1	RP310F06	52
1-1415026-1	PT	PT280T30	123	2-1393146-4	RM 2/3/7	RM203125	132	2-1393230-1	RP II/1	RP310F12	52
1-1415030-1	PB	PB134006	82	2-1393146-5	RM 2/3/7	RM203524	132	2-1393230-2	RP II/1	RP310F24	52
1-1415031-1	PB	PB334024	82	2-1393146-6	RM 2/3/7	RM203615	132	2-1393230-3	RP II/1	RP310F48	52
1-1415034-1	MT	MT320220	129	2-1393146-7	RM 2/3/7	RM203627	132	2-1393230-4	RP II/1	RP310W20	52
1-1415037-1	A, PT, RP, RT	PTMU0524	150	2-1393146-8	RM 2/3/7	RM203730	132	2-1393230-5	RP II/1	RP310005	52
1-1415039-1	PT	PT570R48	123	2-1393146-9	RM 2/3/7	RM205024	132	2-1393230-6	RP II/1	RP310006	52
1-1415041-1	SR6	SR6E4012	110	2-1393147-0	RM 2/3/7	RM737030	132	2-1393230-7	RP II/1	RP310009	52
1-1415044-1	RM 2/3/7	RM232LC4	132	2-1393147-1	RM 2/3/7	RM738012	132	2-1393230-8	RP II/1	RP310010	52
1-1415048-1	PT	PT370R48	123	2-1393147-2	RM 2/3/7	RM738730	132	2-1393230-9	RP II/1	RP310012	52
1-1415054-1	SR4 D/M	SR4M4036	105	2-1393147-3	RM 2/3/7	RM739221	132	2-1393231-0	RP II/1	RP418F12	52
1-1415055-1	SR4 D/M	SR4D4018	105	2-1393147-4	RM 8	RM805LC4	140	2-1393231-1	RP II/1	RP418F24	52
1-1415056-1	SR6sensitive	SR6B4S06	113	2-1393147-5	RM 8	RM805054	140	2-1393231-2	RP II/1	RP418005	52
1-1415057-1	SR6sensitive	SR6A4S06	113	2-1393147-6	RM 8	RM805048	140	2-1393231-3	RP II/1	RP418006	52
1-1415058-1	SR6sensitive	SR6C4S06	113	2-1393147-7	RM 8	RM805072	140	2-1393231-4	RP II/1	RP418009	52
1-1415059-1	SNR	V23092-A1024-A901	28	2-1393147-8	RM 8	RM805512	140	2-1393231-5	RP II/1	RP418012	52
1-1415060-1	SR6 Z	SR6Z4730	116	2-1393147-9	RM 8	RM805524	140	2-1393231-6	RP II/1	RP418013	52
1-1415064-1	PE	PE014C12	22	2-1393148-3	RM 2/3/7	RM205070	132	2-1393231-7	RP II/1	RP418020	52
1-1415068-1	SNR	V23092-A1005-A801	28	2-1393148-5	RM 2/3/7	RM207110	132	2-1393231-8	RP II/1	RP418024	52
1-1415073-1	RT Package	RT4S4LC4	165	2-1393148-6	RM 2/3/7	RM207220	132	2-1393231-9	RP II/1	RP418034	52
1-1415074-1	RT Package	RT4S5R24	165	2-1393148-7	RM 2/3/7	RM207720	132	2-1393232-0	RP II/1	RP818048	52
1-1415075-1	PT Package	PT357LB2	166	2-1393149-2	RM 2/3/7	RM709024	132	2-1393232-1	RP II/1	RP818110	52
1-1415403-0	409 dc	0409 47 022 001	58	2-1393149-8	RM 2/3/7	RM732048	132	2-1393232-2	RP II/1	RP818730	52
1-1415403-1	409 dc	0409 47 023 001	58	2-1393154-0	PT	PT580110	123	2-1393232-3	RP II/1	RP831730	52
1-1415403-2	409 dc	0409 47 026 001	58	2-1393154-1	PT	PT580524	123	2-1393232-4	RP II/1	RP832012	52
1-1415403-3	409 dc	0409 47 027 001	58	2-1393154-2	PT	PT580730	123	2-1393232-5	RP II/1	RP838006	52
1-1415403-4	409 dc	0409 47 028 001	58	2-1393154-3	PT	PT581730	123	2-1393232-6	RP II/1	RP838012	52
1-1415403-5	409 dc	0409 47 030 001	58	2-1393203-0	U/UB	V23148-A0103-C101	77	2-1393232-7	RP II/1	RP838020	52
1-1415403-6	409 dc	0409 47 031 001	58	2-1393203-1	U/UB	V23148-A0105-A101	77	2-1393232-8	RP II/1	RP838024	52
1-1415403-7	409 dc	0409 47 034 001	58	2-1393203-2	U/UB	V23148-A0105-B101	77	2-1393232-9	RP II/1	RP838048	52
1-1415404-0	430 3mm	0430 25 0811 03	93	2-1393203-3	U/UB	V23148-A0105-C101	77	2-1393234-2	RP II/2	RP82C005	72
1-1415404-1	430 3mm	0430 25 0911 00	93	2-1393203-4	U/UB	V23148-A0107-A101	77	2-1393234-3	RP II/2	RP82C615	72
1-1415404-2	430 3mm	0430 25 0911 05	93	2-1393203-5	U/UB	V23148-A0107-B101	77	2-1393234-4	RP II/2	RP820A12	72
1-1415404-3	430 3mm	0430 25 1011 00	93	2-1393203-6	U/UB	V23148-A0107-C101	77	2-1393234-6	RP II/2	RP820F06	72
1-1415404-4	430 3mm	0430 25 2711 00	93	2-1393203-7	U/UB	V23148-A1005-A101	77	2-1393234-7	RP II/2	RP820W19	72
1-1415404-5	430 3mm	0430 25 2711 01	93	2-1393203-8	U/UB	V23148-A1007-A101	77	2-1393235-0	RP II/2	RP421A24	72
1-1415404-6	430 3mm	0430 25 2811 00	93	2-1393203-9	U/UB	V23148-A1105-A101	77	2-1393235-1	RP II/2	RP421B10	72
1-1415404-7	430 3mm	0430 25 2811 04	93	2-1393210-0	T9A	T9AS1D12-5	87	2-1393235-2	RP II/2	RP421F06	72
1-1415404-8	430 3mm	0430 25 5711 08	93	2-1393210-2	T9A	T9AS1D12-9	87	2-1393235-3	RP II/2	RP421W19	72
1-1415404-9	430 3mm	0430 25 8911 10	93	2-1393210-4	T9A	T9AS1L12-12	87	2-1393235-4	RP II/2	RP421018	72
1-1415410-0	410 125°C	0410 63 014 000	63	2-1393210-5	T9A	T9AS1L12-24	87	2-1393235-5	RP II/2	RP421080	72
1-1415410-1	410 125°C	0410 63 016 000	63	2-1393215-1	Card E	V23057-A0006-A101	74	2-1393235-6	RP II/2	RP421524	72
1-1415410-2	410 125°C	0410 63 017 000	63	2-1393215-2	Card E	V23057-A0006-A102	74	2-1393235-7	RP II/2	RP421730	72
1-1415410-3	410 125°C	0410 63 020 000	63	2-1393215-3	Card E	V23057-A0006-A201	74	2-1393235-8	RP II/2	RP427F24	72
1-1415410-4	410 125°C	0410 63 022 000	63	2-1393215-4	Card E	V23057-A0006-A202	74	2-1393235-9	RP II/2	RP440005	72
1-1415410-5	410 125°C	0410 63 022 001	63	2-1393215-5	Card E	V23057-A0006-A401	74	2-1393236-1	SNR	V23092-A1024-A201	28
1-1415410-6	410 125°C	0410 63 022 002	63	2-1393215-7	Card E	V23057-A0006-A402	74	2-1393236-2	SNR	V23092-A1024-A202	28
1-1415410-7	410 125°C	0410 63 023 000	63	2-1393215-8							

Part number reference list

Part No	Relay	Product key	Page	Part No	Relay	Product key	Page	Part No	Relay	Product key	Page
2-1393238-9	RT1 dc/ac	RTB34005	37	2-1415410-1	410 125°C	0410 63 026 000	63	3-1393215-6	Card E	V23057-A0011-A201	74
2-1393239-1	RT1 dc/ac	RT115024	37	2-1415410-2	410 125°C	0410 63 027 000	63	3-1393215-8	Card E	V23057-A0013-A101	74
2-1393239-2	RT1 dc/ac	RT115110	37	2-1415410-3	410 125°C	0410 63 028 000	63	3-1393215-9	Card E	V23057-A0013-A201	74
2-1393239-3	RT1 dc/ac	RT134005	37	2-1415410-4	410 125°C	0410 63 029 000	63	3-1393216-1	Card E	V23057-D0002-A102	74
2-1393239-4	RT1 dc/ac	RT134006	37	2-1415410-5	410 125°C	0410 63 030 000	63	3-1393216-2	Card E	V23057-D0002-A402	74
2-1393239-5	RT1 dc/ac	RT134009	37	2-1415410-6	410 125°C	0410 63 031 000	63	3-1393216-3	Card E	V23057-D0002-A403	74
2-1393239-6	RT1 dc/ac	RT134012	37	2-1415410-7	410 125°C	0410 63 042 001	63	3-1393216-4	Card E	V23057-D0006-A102	74
2-1393239-8	RT1 dc/ac	RT134018	37	2-1415410-8	410 125°C	0410 63 043 001	63	3-1393216-5	Card E	V23057-D0006-A402	74
2-1393239-9	RT1 dc/ac	RT134020	37	2-1415410-9	410 125°C	0410 63 044 001	63	3-1393216-6	Card E	V23057-D0011-A402	74
2-1393240-0	RT1 dc/ac	RT315524	37	2-1415410-0	419	0419 01 1601 09	99	3-1393216-8	Card E	V23057-D0011-A403	74
2-1393240-1	RT1 intrush	RT33KA05	44	2-1415419-1	419	0419 01 1601 10	99	3-1393216-9	Card E	V23057-D0023-A102	74
2-1393240-2	RT1 intrush	RT33K005	44	2-1415419-2	419	0419 01 1603 07	99	3-1393222-4	MSR	V23061-A1006-A302	34
2-1393240-3	RT1 intrush	RT33LF12	44	2-1415419-3	419	0419 01 1603 08	99	3-1393222-5	MSR	V23061-A1006-A402	34
2-1393240-4	RT1 intrush	RT33K024	44	2-1415419-4	419	0419 01 1603 10	99	3-1393222-6	MSR	V23061-A1006-A502	34
2-1393240-5	RT1 intrush	RT33K048	44	2-1415419-5	419	0419 01 1603 11	99	3-1393222-7	MSR	V23061-A1006-A602	34
2-1393240-6	RT1 intrush	RT33LA06	44	2-1415419-6	419	0419 01 2901 00	99	3-1393222-9	MSR	V23061-A1007-A302	34
2-1393240-7	RT1 intrush	RT33LA12	44	2-1415419-7	419	0419 01 2901 01	99	3-1393223-5	MSR	V23061-B1008-A401	34
2-1393240-8	RT1 intrush	RT33LF12	44	2-1415419-8	419	0419 01 2901 02	99	3-1393223-6	MSR	V23061-B1008-A501	34
2-1393240-9	RT1 intrush	RT33LF24	44	2-1415419-9	419	0419 01 3103 04	99	3-1393223-7	MSR	V23061-B1009-A301	34
2-1393243-0	RT2 dc/ac	RTE25012	67	2-1415430-0	430 1/2pole	0430 06 0303 00	96	3-1393223-8	MSR	V23061-B1009-A401	34
2-1393243-1	RT2 dc/ac	RTE25024	67	2-1415430-1	430 1/2pole	0430 06 0311 00	96	3-1393223-9	MSR	V23061-B1009-A501	34
2-1393243-2	RT2 dc/ac	RTE25060	67	2-1415430-2	430 1/2pole	0430 06 0611 01	96	3-1393224-0	RY II	RYA52012	31
2-1393243-3	RT2 dc/ac	RTE25110	67	2-1415430-3	430 1/2pole	0430 06 0613 00	96	3-1393224-1	RY II	RY210005	31
2-1393243-4	RT2 dc/ac	RTE25524	67	2-1415430-4	430 1/2pole	0430 06 0701 00	96	3-1393224-2	RY II	RY210006	31
2-1393243-6	RT2 dc/ac	RTE25615	67	2-1415430-5	430 1/2pole	0430 06 0703 00	96	3-1393224-3	RY II	RY210009	31
2-1393243-8	RT2 dc/ac	RTE25730	67	2-1415430-6	430 1/2pole	0430 06 0703 04	96	3-1393224-4	RY II	RY210010	31
2-1393250-1	W28	W28-XQ1A-0.50	167	2-1415430-7	430 1/2pole	0430 06 0711 00	96	3-1393224-5	RY II	RY210012	31
2-1393250-3	W28	W28-XQ1A-1	167	2-1415430-8	430 1/2pole	0430 06 0711 09	96	3-1393224-6	RY II	RY210015	31
2-1393250-5	W28	W28-XQ1A-10	167	2-1415430-9	430 1/2pole	0430 06 0713 00	96	3-1393224-7	RY II	RY210018	31
2-1393250-7	W28	W28-XQ1A-12	167	2-1416000-0	MSR	V23061-A1016-A302	34	3-1393224-8	RY II	RY210024	31
2-1393250-8	W28	W28-XQ1A-13	167	2-1419104-1	T9A	T9AS1D22-24	87	3-1393224-9	RY II	RY210032	31
2-1393258-0	SR2 M	V23047-A1036-A501	102	2-1419104-2	T9A	T9AS1D22-48	87	3-1393225-0	RY II	RY612048	31
2-1393258-1	SR2 M	V23047-A1040-A501	102	2-1419108-1	Acc. RT	RT78624	150	3-1393225-1	RY II	RY613012	31
2-1393258-2	SR2 M	V23047-A1040-A511	102	2-1419108-2	Acc. RT	RT78625	150	3-1393225-2	RY II	RY613018	31
2-1393258-3	SR2 M	V23047-A1060-A511	102	2-1419108-3	Acc. RT	RT78626	150	3-1393225-3	RY II	RY613024	31
2-1393844-0	RM 2/3/7	RM738024	132	2-1419135-1	PE	PE014015	22	3-1393225-4	RY II	RY613048	31
2-1393844-1	RM 2/3/7	RM7380C4	132	2-1419136-2	RMC/RMD	RMD35024	143	3-1393225-5	RY II	RY613060	31
2-1393844-2	RM 2/3/7	RM739730	132	2-1419136-5	RP II/1	RP31D524	52	3-1393230-0	RP II/1	RP310018	52
2-1393844-3	Acc. RM	RM78702	162	2-1419136-6	RP II/1	RP330009	52	3-1393230-1	RP II/1	RP310020	52
2-1393844-4	Acc. RM	RM78704	162	2-1419136-7	RP II/2	RP42C110	72	3-1393230-2	RP II/1	RP310024	52
2-1393844-5	Acc. RM	RM78705	162	2-1419136-8	RP II/1	RP818028	52	3-1393230-3	RP II/1	RP310048	52
2-1393844-6	RM 8	RM805012	140	2-1419142-2	PE	PE014003	22	3-1393230-4	RP II/1	RP310060	52
2-1393844-7	RM 8	RM805024	140	2-1419142-3	RE	RE032021	26	3-1393230-5	RP II/1	RP310110	52
2-1393844-8	RM 8	RM805720	140	2-1419143-0	RP3SL	RP75L005	55	3-1393230-7	RP II/1	RP310524	52
2-1393844-9	RM 8	RM808024	140	2-1419143-1	RP3SL	RP75L110	55	3-1393230-8	RP II/1	RP310548	52
2-1415004-1	RY II	RY533036	31	2-1419143-2	RP II/1	RP811006	52	3-1393230-9	RP II/1	RP310615	52
2-1415006-1	RP II/2	RP421030	72	2-1419143-3	RP II/1	RP811110	52	3-1393231-0	RP II/1	RP418048	52
2-1415008-1	PT	PT531615	123	2-1419143-4	RP II/1	RP811F05	52	3-1393231-1	RP II/1	RP418060	52
2-1415009-1	RM 2/3/7	RM705048	132	2-1419143-5	RP II/1	RP812006	52	3-1393231-2	RP II/1	RP418110	52
2-1415012-1	SR2 M	V23047-A1110-A511	102	2-1419143-6	RP II/1	RP812048	52	3-1393231-3	RP II/1	RP418524	52
2-1415013-1	MT	MT228110	129	2-1419143-7	RP II/1	RP812060	52	3-1393231-4	RP II/1	RP418548	52
2-1415014-1	MT	MT328127	129	2-1419143-8	RP II/1	RP812127	52	3-1393231-5	RP II/1	RP418615	52
2-1415017-1	SR6	V23050-A1005-A551	110	2-1419151-0	RP II/1	RP438018	52	3-1393231-6	RP II/1	RP418730	52
2-1415018-1	SR6	V23050-A1018-A533	110	2-1419151-3	RP II/2	RP440110	72	3-1393231-7	RP II/1	RP419012	52
2-1415019-1	SR6	V23050-A1048-A551	110	2-1419151-7	RP II/2	RP440F24	72	3-1393231-8	RP II/1	RP419024	52
2-1415020-1	RM 5/6	RM505512	136	2-1419152-3	Acc. RP,RT	RPMG0110	150	3-1393231-9	RP II/1	RP419110	52
2-1415021-1	RT1 bistable	RT234F12	40	2-1419152-4	Acc. RP,RT	RPMG0524	150	3-1393232-0	RP II/1	RP838110	52
2-1415024-1	RT1 bistable	RT315F12	40	2-1419152-5	Acc. RP,RT	RPMG0730	150	3-1393232-1	RP II/1	RP852024	52
2-1415025-1	SNR Package	ST1P3L12	164	2-1419152-6	RT1 bistable	RT334F24	40	3-1393233-1	RP II/1	RP310A04	52
2-1415026-1	PT	PT380L24	123	3-1393107-2	RM 2/3/7	RM232048	132	3-1393233-2	RP II/1	RP310A05	52
2-1415028-1	SR6	SR6F4024	110	3-1393107-4	RM 2/3/7	RM232730	132	3-1393233-3	RP II/1	RP310B10	52
2-1415030-1	PB	PB134012	82	3-1393107-5	RM 2/3/7	RM233024	132	3-1393233-4	RP II/1	RP310F60	52
2-1415036-1	A. PT,RP,RT	PTMG0024	150	3-1393107-8	RM 2/3/7	RM302LC4	132	3-1393233-5	RP II/1	RP300012	52
2-1415037-1	A. PT,RP,RT	PTMU0730	150	3-1393146-0	RM 2/3/7	RM205524	132	3-1393234-5	RP II/1	RP830524	52
2-1415039-1	PT	PT270S15	123	3-1393146-1	RM 2/3/7	RM205615	132	3-1393234-7	RP II/1	RP832615	52
2-1415040-1	SR6	SR6E4024	110	3-1393146-2	RM 2/3/7	RM205730	132	3-1393234-9	RP II/1	RP838524	52
2-1415041-1	SR6	SR6E4048	110	3-1393146-3	RM 2/3/7	RM207024	132	3-1393235-0	RP II/2	RP440006	72
2-1415042-1	SR6 Z	SR6ZA036	116	3-1393146-4	RM 2/3/7	RM207730	132	3-1393235-1	RP II/2	RP440009	72
2-1415044-1	RP II/1	RP31L048	52	3-1393146-5	RM 2/3/7	RM208024	132	3-1393235-2	RP II/2	RP441F05	72
2-1415045-1	PT	PT571220	123	3-1393146-6	RM 2/3/7	RM209730	132	3-1393235-3	RP II/2	RP441012	72
2-1415054-1	SR4 D/M	SR4M4040	105	3-1393146-8	RM 2/3/7	RM232024	132	3-1393235-4	RP II/2	RP441060	72
2-1415055-1	SR4 D/M	SR4D4021	105	3-1393146-9	RM 2/3/7	RM232524	132	3-1393235-5	RP II/2	RP441090	72
2-1415056-1	SR6sensitive	SR6B4S09	113	3-1393147-0	RM 8	RM805548	140	3-1393235-6	RP II/2	RP460F24	72
2-1415057-1	SR6sensitive	SR6A4S09	113	3-1393147-1	RM 8	RM805615	140	3-1393235-7	RP II/2	RP82AF24	72
2-1415058-1	SR6sensitive	SR6C4S09	113	3-1393147-2	RM 8	RM805627	140	3-1393235-8	RP II/2	RP82AF48	72
2-1415060-1	SR6 Z	SR6ZB524	116	3-1393147-3	RM 8	RM805730	140	3-1393235-9	RP II/2	RP82A012	72
2-1415062-1	RM 8	RM8351B0	140	3-1393147-4	RM 8	RM805900	140	3-1393236-0	SNR	V23092-A1024-A801	28
2-1415064-1	PE	PE014C06	22	3-1393147-6	RM 8	RM808012	140	3-1393236-5	SNR	V23092-A1048-A201	28
2-1415068-1	SNR	V23092-A1012-A802	28	3-1393147-7	RM 8	RM808024	140	3-1393236-6	SNR	V23092-A1048-A202	28
2-1415073-1	RT Package	RT454R24	165	3-1393147-8	RM 8	RM809615	140	3-1393236-7	SNR	V23092-A1048-A301	28
2-1415074-1	RT Package	RT455T30	165	3-1393147-9	RM 8	RM809730	140	3-1393236-8	SNR	V23092-A1048-A302	28
2-1415075-1	PT Package	PT3S7LC4	166	3-1393148-9	RM 2/3/7	RM235012	132	3-1393236-9	SNR	V23092-A1048-A801	28
2-1415403-7	409 bistable	0409 67 001 000	58	3-1393149-6	RM 2/3/7	RM735024	132	3-1393238-0	RT1 dc/ac	RTB34012	37
2-1415403-8	409 bistable	0409 67 002 000	58	3-1393149-7	RM 2/3/7	RM735524	132	3-1393238-1	RT1 dc/ac	RTB34015	37
2-1415403-9	409 bistable	0409 67 003 000	58	3-1393161-3	Acc. RT	RT16016	150	3-1393238-2	RT1 dc/ac	RTB34018	37
2-1415404											

Part number reference list

Part No	Relay	Product key	Page	Part No	Relay	Product key	Page	Part No	Relay	Product key	Page
3-1393239-5	RT1 dc/ac	RT134730	37	3-1415419-1	419	0419 01 3103 12	99	4-1393230-9	RP II/1	RP330024	52
3-1393239-6	RT1 sensitive	RT174005	42	3-1415419-2	419	0419 01 5803 07	99	4-1393231-0	RP II/1	RP430F12	52
3-1393239-7	RT1 sensitive	RT174006	42	3-1415419-3	419	0419 01 6003 07	99	4-1393231-1	RP II/1	RP430012	52
3-1393239-8	RT1 sensitive	RT174012	42	3-1415430-0	430 1/2pole	0430 06 0721 07	96	4-1393231-2	RP II/1	RP430024	52
3-1393239-9	RT1 sensitive	RT174024	42	3-1415430-1	430 1/2pole	0430 06 0901 00	96	4-1393231-3	RP II/1	RP430524	52
3-1393240-0	RT1 inrush	RT33L005	44	3-1415430-2	430 1/2pole	0430 06 0903 00	96	4-1393231-4	RP II/1	RP430615	52
3-1393240-1	RT1 inrush	RT33L006	44	3-1415430-3	430 1/2pole	0430 06 0911 00	96	4-1393231-5	RP II/1	RP431012	52
3-1393240-2	RT1 inrush	RT33L009	44	3-1415430-4	430 1/2pole	0430 06 0911 06	96	4-1393231-6	RP II/1	RP431024	52
3-1393240-3	RT1 inrush	RT33L012	44	3-1415430-5	430 1/2pole	0430 06 0913 00	96	4-1393231-7	RP II/1	RP432012	52
3-1393240-4	RT1 inrush	RT33L018	44	3-1415430-6	430 1/2pole	0430 06 1003 00	96	4-1393231-8	RP II/1	RP432024	52
3-1393240-5	RT1 inrush	RT33L024	44	3-1415430-7	430 1/2pole	0430 06 1011 00	96	4-1393231-9	RP II/1	RP438009	52
3-1393240-6	RT1 inrush	RT33L048	44	3-1415430-8	430 1/2pole	0430 06 1013 00	96	4-1393233-0	RP II/1	RP330A24	52
3-1393240-7	RT1 inrush	RT33L060	44	3-1415430-9	430 1/2pole	0430 06 1101 00	96	4-1393233-1	RP II/1	RP330018	52
3-1393240-8	RT1 bistable	RT334F05	40	3-1419104-3	T9A	T9AS5D22-12	87	4-1393233-5	RP II/1	RP410F06	52
3-1393240-9	RT1 bistable	RT334F12	40	3-1419104-6	T9A	T9AS5D22-24	87	4-1393233-6	RP II/1	RP411A05	52
3-1393243-0	RT2 bistable	RTE44A24	70	3-1419108-5	RT1 dc/ac	RTD34012	37	4-1393233-8	RP II/1	RP412009	52
3-1393243-1	RT2 dc/ac	RTE44009	67	3-1419108-8	RT1 dc/ac	RTD34024	37	4-1393234-0	RP II/1	RP838615	52
3-1393243-2	RT2 dc/ac	RTE44012	67	3-1419111-8	Acc. PT	PT16016	154	4-1393234-9	RP II/2	RP840009	72
3-1393243-3	RT2 dc/ac	RTE44024	67	3-1419111-9	Acc. PT	PT16040	154	4-1393234-5	RP II/2	RP840524	72
3-1393243-4	RT2 dc/ac	RTE44615	67	3-1419121-6	PCD	PCD-105-D1MH	80	4-1393234-6	RP II/2	RP858615	52
3-1393243-5	RT2 dc/ac	RTE44730	67	3-1419136-7	RT1 sensitive	RT174036	42	4-1393234-7	RP II/2	RP420005	72
3-1393250-0	W28	W28-XQ1A-15	167	3-1419136-9	RT1 inrush	RT31LA06	44	4-1393234-8	RP II/2	RP420006	72
3-1393250-1	W28	W28-XQ1A-16	167	3-1419143-0	RP II/1	RP81A110	52	4-1393234-9	RP II/2	RP420009	72
3-1393250-2	W28	W28-XQ1A-2	167	3-1419143-8	RP II/1	RP831110	52	4-1393235-0	RP II/2	RP82A048	72
3-1393250-3	W28	W28-XQ1A-20	167	3-1419143-9	RP II/1	RP831615	52	4-1393235-1	RP II/2	RP82A730	72
3-1393250-4	W28	W28-XQ1A-3	167	3-1419151-2	RP II/2	RP441730	72	4-1393235-2	RP II/2	RP82C024	72
3-1393250-7	W28	W28-XQ1A-4	167	3-1419151-9	RP II/1	RP710010	52	4-1393235-3	RP II/2	RP82C730	72
3-1393250-8	W28	W28-XQ1A-5	167	4-1393090-8	MT	MT221006	129	4-1393235-4	RP II/2	RP82F24	72
3-1393250-9	W28	W28-XQ1A-6	167	4-1393090-9	MT	MT221012	129	4-1393235-5	RP II/2	RP820015	72
3-1393252-7	W6	W67-X2Q10-2	171	4-1393091-4	MT	MT311060	129	4-1393235-6	RP II/2	RP821A24	72
3-1393253-2	W6	W68-X2Q12-15	171	5-1419150-3	RM 2/3/7	RM302730	132	4-1393235-7	RP II/2	RP821F60	72
3-1393253-4	W6	W68-X2Q12-20	171	4-1393146-0	RM 2/3/7	RM232615	132	4-1393235-8	RP II/2	RP821005	72
3-1393253-7	W6	W68-X2Q12-30	171	4-1393146-2	RM 2/3/7	RM233615	132	4-1393235-9	RP II/2	RP821110	72
3-1393253-8	W6	W68-X2Q12-5	171	4-1393146-4	RM 2/3/7	RM235048	132	4-1393236-2	SNR	V23092-A1060-A201	28
3-1393844-0	RM 8	RM809012	140	4-1393146-5	RM 2/3/7	RM235730	132	4-1393236-3	SNR	V23092-A1060-A301	28
3-1393844-1	RM 8	RM835012	140	4-1393146-6	RM 2/3/7	RM235740	132	4-1393236-4	SNR	V23092-A1060-A302	28
3-1415001-1	RT1 bistable	RT314A60	40	4-1393146-7	RM 2/3/7	RM238012	132	4-1393238-0	RT1 dc/ac	RTB34730	37
3-1415002-1	PT	PT270T30	123	4-1393146-8	RM 2/3/7	RM302LE8	132	4-1393238-1	RT1 dc/ac	RTB35730	37
3-1415006-1	SR2 M	V23047-A1048-A501	102	4-1393146-9	RM 2/3/7	RM302MBO	132	4-1393238-2	RT1 sensitive	RTB74005	42
3-1415007-1	RY II	RYA30021	31	4-1393147-0	RM 8	RM835L12	140	4-1393238-3	RT1 sensitive	RTB74009	42
3-1415011-1	SR2 M	V23047-A1006-A501	102	4-1393147-1	RM 8	RM835024	140	4-1393238-4	RT1 sensitive	RTB74012	42
3-1415013-1	MT	MT228127	129	4-1393147-2	RM 8	RM835048	140	4-1393238-5	RT1 sensitive	RTB74018	42
3-1415015-1	RM 2/3/7	RM232V00	132	4-1393147-3	RM 8	RM835524	140	4-1393238-6	RT1 sensitive	RTB74024	42
3-1415017-1	SR6	V23050-A1006-A551	110	4-1393147-4	RM 8	RM835615	140	4-1393238-7	RT1 sensitive	RTB84009	42
3-1415018-1	SR6	V23050-A1021-A533	110	4-1393147-5	RM 8	RM835720	140	4-1393238-8	RT1 dc/ac	RTC14006	37
3-1415019-1	SR6	V23050-A1060-A551	110	4-1393147-6	RM 8	RM835730	140	4-1393238-9	RT1 dc/ac	RTC14012	37
3-1415020-1	PT	PT570N20	123	4-1393147-7	RM 8	RM838012	140	4-1393239-0	RT1 sensitive	RT174048	42
3-1415021-1	SR2 M	V23047-A1080-A501	102	4-1393147-8	RM 8	RM838024	140	4-1393239-1	RT1 sensitive	RT174060	42
3-1415022-1	RT1 inrush	RTD3KF05	44	4-1393147-9	RM 8	RM838048	140	4-1393239-2	RT1 sensitive	RT175005	42
3-1415024-1	SNR Package	ST1P3024	164	4-1393148-4	RM 2/3/7	RM235720	132	4-1393239-3	RT1 sensitive	RT175012	42
3-1415025-1	SNR Package	ST1P3L24	164	4-1393148-7	RM 2/3/7	RM239730	132	4-1393239-4	RT1 sensitive	RT175024	42
3-1415026-1	PT	PT380R24	123	4-1393149-1	RM 2/3/7	RM735730	132	4-1393239-5	RT1 sensitive	RT184005	42
3-1415028-1	PT	PT570L12	123	4-1393149-5	RM 2/3/7	RM739024	132	4-1393239-6	RT1 sensitive	RT184006	42
3-1415030-1	PB	PB134024	82	4-1393149-9	Acc. RM	RM78701	162	4-1393239-7	RT1 sensitive	RT184012	42
3-1415035-1	Acc. MT	MT178755	158	4-1393211-0	T92	T92P11A22-120	90	4-1393239-8	RT1 sensitive	RT184018	42
3-1415036-1	A. PT,RP,RT	PTMG0524	150	4-1393211-3	T92	T92P11A22-24	90	4-1393239-9	RT1 sensitive	RT184024	42
3-1415037-1	A. PT,RP,RT	PTMV0524	150	4-1393211-4	T92	T92P11A22-240	90	4-1393240-0	RT1 dc/ac	RT334005	37
3-1415040-1	SR6	SR6F4018	110	4-1393215-0	Card E	V23057-A0013-A401	74	4-1393240-1	RT1 dc/ac	RT334006	37
3-1415041-1	SR6	SR6E4110	110	4-1393215-2	Card E	V23057-A0013-A901	74	4-1393240-3	RT1 dc/ac	RT334009	37
3-1415042-1	SR6 Z	SR6ZC024	116	4-1393215-6	Card E	V23057-A0014-A401	74	4-1393240-5	RT1 dc/ac	RT334012	37
3-1415043-1	Acc. PT	PT78604	154	4-1393215-7	Card E	V23057-A0015-A201	74	4-1393240-6	RT1 dc/ac	RT334015	37
3-1415044-1	RM 8	RM809548	140	4-1393215-8	Card E	V23057-A0015-A401	74	4-1393240-7	RT1 dc/ac	RT334018	37
3-1415046-1	PT	PT581012	123	4-1393215-9	Card E	V23057-A0015-B101	74	4-1393240-8	RT1 dc/ac	RT334024	37
3-1415053-1	PE	PE014A06	22	4-1393216-1	Card E	V23057-E0006-A201	74	4-1393240-9	RT1 dc/ac	RT334036	37
3-1415054-1	SR4 D/M	SR4M4048	105	4-1393216-2	Card E	V23057-F0006-A201	74	4-1393243-2	RT2 dc/ac	RT423024	67
3-1415055-1	SR4 D/M	SR4D4024	105	4-1393216-3	Card E	V23057-F0008-A201	74	4-1393243-3	RT2 dc/ac	RT423730	67
3-1415056-1	SR6sensitive	SR6B4S12	113	4-1393222-2	MSR	V23061-A1007-A402	34	4-1393243-4	RT2 bistable	RT424A05	70
3-1415057-1	SR6sensitive	SR6A4S12	113	4-1393222-6	MSR	V23061-A1007-A502	34	4-1393243-5	RT2 bistable	RT424A06	70
3-1415058-1	SR6sensitive	SR6C4S12	113	4-1393222-7	MSR	V23061-A1007-A602	34	4-1393243-6	RT2 bistable	RT424A12	70
3-1415060-1	SR6 Z	SR6ZB730	116	4-1393223-0	MSR	V23061-B1009-A601	34	4-1393243-7	RT2 bistable	RT424A24	70
3-1415064-1	PE	PE014C05	22	4-1393223-2	MSR	V23061-B1010-A401	34	4-1393243-9	RT2 bistable	RT424A36	70
3-1415068-1	SNR	V23092-A1048-A802	28	4-1393223-3	MSR	V23061-B1010-A501	34	4-1393250-0	W28	W28-XQ1A-7	167
3-1415073-1	RT Package	RT4S4T30	165	4-1393223-4	MSR	V23061-B1010-A601	34	4-1393250-1	W28	W28-XQ1A-8	167
3-1415074-1	RT Package	RT3SKLC4	165	4-1393223-7	MSR	V23061-B1011-A401	34	4-1393250-5	W28	W28-XQ1B-3	167
3-1415075-1	PT Package	PT5S8RC4	166	4-1393223-8	MSR	V23061-B1013-A401	34	4-1393254-7	W9	W91-X152-35	171
3-1415404-0	430 3mm	0430 45 2811 01	93	4-1393223-9	MSR	V23061-B1014-A501	34	4-1393844-5	RMC/RMD	RMC05024	143
3-1415404-1	430 3mm	0430 45 2811 03	93	4-1393224-0	RY II	RY210036	31	4-1393844-6	RMC/RMD	RMC05048	143
3-1415404-2	430 1/2pole	0430 46 0711 01	96	4-1393224-1	RY II	RY210048	31	4-1393844-7	RMC/RMD	RMD05730	143
3-1415404-3	430 1/2pole	0430 46 0712 01	96	4-1393224-2	RY II	RY211005	31	4-1415007-1	RTHsensitive	RTH84005	48
3-1415404-4	430 1/2pole	0430 46 0713 01	96	4-1393224-3	RY II	RY211006	31	4-1415011-1	MT	MT221125	129
3-1415404-5	430 1/2pole	0430 46 5811 02	96	4-1393224-4	RY II	RY211008	31	4-1415014-1	MT	MT226127	129
3-1415404-6	430 1/2pole	0430 46 5812 02	96	4-1393224-5	RY II	RY211009	31	4-1415017-1	SR6	V23050-A1009-A551	110
3-1415404-7	430 1/2pole	0430 46 5813 02	96	4-1393224-6	RY II	RY211012	31	4-1415018-1	SR6	V23050-A1036-A533	110
3-1415404-8	430 1/2pole	0430 46 6811 03	96	4-1393224-7	RY II	RY211018	31	4-1415019-1	SR6	V23050-A1085-A551	110
3-1415404-9	430 3mm	0430 55 1001 00	93	4-1393224-8	RY II	RY211021	31	4-1415021-1	SR2 M	V23047-A1080-A511	102
3-1415410-0	410 125°C	0410 63 046 001	63	4-1393224-9	RY II	RY211024	31	4-			

Part number reference list

Part No	Relay	Product key	Page	Part No	Relay	Product key	Page	Part No	Relay	Product key	Page
4-1415043-1	Acc. PT	PT78600	154	5-1393147-1	RM 8	RM838730	140	5-1393240-1	RT1 dc/ac	RT334060	37
4-1415044-1	RM 8	RM808548	140	5-1393147-2	RM 8	RM8390C4	140	5-1393240-2	RT1 dc/ac	RT334110	37
4-1415046-1	Acc. MT	MT78623	158	5-1393147-3	RM 8	RM839012	140	5-1393240-3	RT1 dc/ac	RT334506	37
4-1415053-1	SR4 D/M	SR4M4024	105	5-1393147-4	RM 8	RM839024	140	5-1393240-4	RT1 dc/ac	RT334524	37
4-1415054-1	SR4 D/M	SR4M4060	105	5-1393147-5	RM 8	RM839524	140	5-1393240-5	RT1 dc/ac	RT334615	37
4-1415055-1	SR4 D/M	SR4D4036	105	5-1393147-6	RM 8	RM839730	140	5-1393240-6	RT1 dc/ac	RT334730	37
4-1415056-1	SR6sensitive	SR6B4S18	113	5-1393149-7	RM 8	RM808730	140	5-1393243-0	RT2 bistable	RT424A60	70
4-1415057-1	SR6sensitive	SR6A4S18	113	5-1393149-8	RM 8	RM809024	140	5-1393243-1	RT2 bistable	RT424F03	70
4-1415058-1	SR6sensitive	SR6C4S18	113	5-1393211-3	T92	T92P11D22-12	90	5-1393243-2	RT2 bistable	RT424F05	70
4-1415060-1	SR6 Z	SR6ZC524	116	5-1393211-4	T92	T92P11D22-24	90	5-1393243-3	RT2 bistable	RT424F06	70
4-1415062-1	RM 2/3/7	RM732006	132	5-1393211-7	T92	T92P7A22-120	90	5-1393243-4	RT2 bistable	RT424F12	70
4-1415063-1	RT1 inrush	RT15L024	44	5-1393215-0	Card E	V23057-A0016-A402	74	5-1393243-5	RT2 bistable	RT424F18	70
4-1415064-1	PE	PE014A04	22	5-1393215-3	Card E	V23057-A0018-A101	74	5-1393243-6	RT2 bistable	RT424F24	70
4-1415073-1	RT Package	RT3S4LC4	165	5-1393215-4	Card E	V23057-A0018-A401	74	5-1393243-7	RT2 bistable	RT424F48	70
4-1415074-1	RT Package	RT3SLLC4	165	5-1393215-5	Card E	V23057-A0023-A101	74	5-1393243-8	RT2 dc/ac	RT424003	67
4-1415075-1	PT Package	PT5S8TD0	166	5-1393215-6	Card E	V23057-A0023-A401	74	5-1393243-9	RT2 dc/ac	RT424005	67
4-1415404-0	430 3mm	0430 55 1001 01	93	5-1393215-7	Card E	V23057-A0023-B101	74	5-1393250-3	W28	W28-XQ8B-3	167
4-1415410-0	410 3mm	0410 83 001 000	65	5-1393215-9	Card E	V23057-A0028-A101	74	5-1393252-7	W6	W67-X2Q12-2	171
4-1415410-1	410 3mm	0410 83 002 000	65	5-1393222-4	MSR	V23061-A1008-A302	34	5-1415002-1	PT	PT370L24	123
4-1415410-2	410 3mm	0410 83 003 000	65	5-1393222-5	MSR	V23061-A1008-A402	34	5-1415006-1	PT	PT380220	123
4-1415410-3	410 3mm	0410 83 004 000	65	5-1393222-6	MSR	V23061-A1009-A402	34	5-1415008-1	RM 5/6	RM507524	136
4-1415410-4	410 3mm	0410 83 005 000	65	5-1393222-7	MSR	V23061-A1009-A502	34	5-1415011-1	MT	MT221250	129
4-1415410-5	410 3mm	0410 83 008 000	65	5-1393222-8	MSR	V23061-A1009-A602	34	5-1415012-1	MT	MT223006	129
4-1415410-6	410 3mm	0410 83 042 001	65	5-1393224-0	RY II	RY211036	31	5-1415014-1	RT1 inrush	RT33K110	44
4-1415410-7	410 3mm	0410 83 043 001	65	5-1393224-1	RY II	RY211048	31	5-1415015-1	RM 2/3/7	RM309900	132
4-1415410-8	410 3mm	0410 83 046 001	65	5-1393224-2	RY II	RY212005	31	5-1415017-1	SR6	V23050-A1015-A551	110
4-1415410-9	410 3mm	0410 83 050 001	65	5-1393224-3	RY II	RY212006	31	5-1415018-1	SR6	V23050-A1040-A533	110
4-1415430-0	430 1/2pole	0430 06 1113 00	96	5-1393224-4	RY II	RY212009	31	5-1415019-1	SR6	V23050-A1110-A551	110
4-1415430-1	430 1/2pole	0430 06 1313 00	96	5-1393224-5	RY II	RY212012	31	5-1415022-1	RP II/2	RP440020	72
4-1415430-2	430 1/2pole	0430 06 3813 01	96	5-1393224-6	RY II	RY212015	31	5-1415024-1	Acc. SNR	ST1FL24	147
4-1415430-3	430 1/2pole	0430 07 0306 00	96	5-1393224-7	RY II	RY212018	31	5-1415025-1	Acc. SNR	ST1FL48	147
4-1415430-4	430 1/2pole	0430 07 0316 00	96	5-1393224-8	RY II	RY212024	31	5-1415026-1	PT	PT580L24	123
4-1415430-5	430 1/2pole	0430 07 0406 00	96	5-1393224-9	RY II	RY212048	31	5-1415027-1	SR6 D/M	SR6D-024-V	108
4-1415430-6	430 1/2pole	0430 07 0606 00	96	5-1393230-0	RP II/1	RP330036	52	5-1415030-1	PB	PB314006	82
4-1415430-7	430 1/2pole	0430 07 0606 07	96	5-1393230-1	RP II/1	RP330048	52	5-1415031-1	PT	PT580M10	123
4-1415430-8	430 1/2pole	0430 07 0616 00	96	5-1393230-2	RP II/1	RP330060	52	5-1415032-1	RT1 dc/ac	RT114548	37
4-1415430-9	430 1/2pole	0430 07 0705 00	96	5-1393230-3	RP II/1	RP330080	52	5-1415033-1	SR6 Z	SR6ZB024	116
4-1419111-0	PT	PT270006	123	5-1393230-4	RP II/1	RP330110	52	5-1415034-1	Acc. PT	PT78741	154
4-1419111-1	PT	PT270012	123	5-1393230-5	RP II/1	RP330524	52	5-1415036-1	A. PT,RP,RT	PTML0024	150
4-1419111-2	PT	PT270024	123	5-1393230-6	RP II/1	RP330615	52	5-1415037-1	Acc. PT	PT17016	154
4-1419111-3	PT	PT270048	123	5-1393230-7	RP II/1	RP330730	52	5-1415043-1	Acc. PT	PT78602	154
4-1419111-4	PT	PT270060	123	5-1393230-8	RP II/1	RP330F05	52	5-1415046-1	RM 5/6	RM6020C4	136
4-1419111-5	PT	PT270110	123	5-1393230-9	RP II/1	RP350012	52	5-1415048-1	PT	PT580560	123
4-1419111-6	PT	PT270220	123	5-1393231-0	RP II/1	RP438012	52	5-1415053-1	SR4 D/M	SR4M4005	105
4-1419111-7	PT	PT270506	123	5-1393231-1	RP II/1	RP438020	52	5-1415054-1	SR4 D/M	SR4M4085	105
4-1419111-8	PT	PT270524	123	5-1393231-2	RP II/1	RP438024	52	5-1415055-1	SR4 D/M	SR4D4040	105
4-1419111-9	PT	PT270548	123	5-1393231-3	RP II/1	RP438048	52	5-1415056-1	SR6sensitive	SR6B4S21	113
4-1419126-8	PCD	PCD-124-D1MH	80	5-1393231-4	RP II/1	RP439012	52	5-1415057-1	SR6sensitive	SR6A4S21	113
4-1419135-0	PT	PT271615	123	5-1393231-5	RP II/1	RP452024	52	5-1415058-1	SR6sensitive	SR6C4S21	113
4-1419135-3	PT	PT280615	123	5-1393231-6	RP II/1	RP458020	52	5-1415060-1	SR6 Z	SR6ZC510	116
4-1419135-5	PT	PT281024	123	5-1393231-7	RP II/1	RP458024	52	5-1415061-1	RM 2/3/7	RM702900	132
4-1419135-6	PT	RT281110	123	5-1393233-0	RP II/1	RP418A06	52	5-1415063-1	SNR	V23092-A1024-A802	28
4-1419136-1	RT1 inrush	RT33LF05	44	5-1393233-1	RP II/1	RP418F05	52	5-1415064-1	PE	PE014C03	22
4-1419136-3	RT2 dc/ac	RT423012	67	5-1393233-3	RP II/2	RP420B10	72	5-1415073-1	RT Package	RT3S4R24	165
4-1419136-4	RT2 dc/ac	RT423048	67	5-1393233-5	RP II/2	RP420W15	72	5-1415074-1	PT Package	PT2S7RC4	166
4-1419136-5	RT2 dc/ac	RT423110	67	5-1393234-0	RP II/2	RP420012	72	5-1415075-1	PT Package	PT5S8LB2	166
4-1419136-6	RT2 dc/ac	RT443012	67	5-1393234-1	RP II/2	RP420024	72	5-1415410-0	410 3mm	0410 83 050 401	65
4-1419142-7	RP II/1	RP411018	52	5-1393234-2	RP II/2	RP420048	72	5-1415410-1	410 3mm	0410 83 054 001	65
4-1419142-8	RP II/1	RP411548	52	5-1393234-3	RP II/2	RP420060	72	5-1415430-0	430 1/2pole	0430 07 0706 00	96
4-1419142-9	RP II/1	RP411A04	52	5-1393234-4	RP II/2	RP420110	72	5-1415430-1	430 1/2pole	0430 07 0706 08	96
4-1419143-0	RP II/1	RP839024	52	5-1393234-5	RP II/2	RP420524	72	5-1415430-2	430 1/2pole	0430 07 0706 09	96
4-1419143-1	RP II/1	RP83B110	52	5-1393234-6	RP II/2	RP420615	72	5-1415430-3	430 1/2pole	0430 07 0716 00	96
4-1419146-2	PCD	PCD-112-D1MH	80	5-1393234-7	RP II/2	RP420730	72	5-1415430-4	430 1/2pole	0430 07 0816 00	96
4-1419151-2	RP II/1	RP710110	52	5-1393234-8	RP II/2	RP420A12	72	5-1415430-5	430 1/2pole	0430 07 0906 00	96
4-1419151-9	RP II/1	RP730006	52	5-1393234-9	RP II/2	RP420A24	72	5-1415430-6	430 1/2pole	0430 07 0914 01	96
4-1419158-4	Card E	V23057-B0017-A401	74	5-1393235-0	RP II/2	RP821730	72	5-1415430-7	430 1/2pole	0430 07 0916 00	96
4-1440006-0	T7N/T7N-WG	T7NS5D1-03	84	5-1393235-1	RP II/2	RP827730	72	5-1415430-8	430 1/2pole	0430 07 1006 00	96
4-1440006-2	T7N/T7N-WG	T7NS5D1-06	84	5-1393235-2	RP II/2	RP841012	72	5-1415430-9	430 1/2pole	0430 07 1016 00	96
4-1440006-4	T7N/T7N-WG	T7NS5D1-12	84	5-1393235-3	RP II/2	RP841024	72	5-1419102-2	T9A	T9AP5D52-24	87
4-1440006-7	T7N/T7N-WG	T7NS5D1-24	84	5-1393235-4	RP II/2	RP841730	72	5-1419102-4	T9A	T9AP5D52-12	87
4-1440006-8	T7N/T7N-WG	T7NS5D1-36	84	5-1393235-5	RP II/2	RP860615	72	5-1419111-0	PT	PT270615	123
4-1440006-9	T7N/T7N-WG	T7NS5D1-48	84	5-1393236-5	SNR	V23092-A1905-A201	28	5-1419111-1	PT	PT270730	123
4-1461068-2	PCLH	PCLH-203A1F	157	5-1393236-6	SNR	V23092-A1905-A202	28	5-1419111-2	PT	PT271012	123
4-1461068-5	PCLH	PCLH-206A1F	157	5-1393236-7	SNR	V23092-A1905-A301	28	5-1419111-3	PT	PT271024	123
5-1393090-0	MT	MT221024	129	5-1393236-8	SNR	V23092-A1905-A302	28	5-1419111-4	PT	PT271048	123
5-1393090-1	MT	MT221048	129	5-1393238-0	RT1 dc/ac	RTC14024	37	5-1419111-5	PT	PT271110	123
5-1393090-2	MT	MT221060	129	5-1393238-1	RT1 dc/ac	RTC14524	37	5-1419111-6	PT	PT271524	123
5-1393090-3	MT	MT221110	129	5-1393238-2	RT1 dc/ac	RTC14615	37	5-1419111-7	PT	PT271548	123
5-1393090-4	MT	MT221220	129	5-1393238-3	RT1 dc/ac	RTC14730	37	5-1419111-8	PT	PT271730	123
5-1393090-5	MT	MT2230C4	129	5-1393238-4	RT1 dc/ac	RTC34012	37	5-1419111-9	Acc. PT	PT28800	154
5-1393090-6	MT	MT223012	129	5-1393238-5	RT1 dc/ac	RTC34024	37	5-1419135-0	PT	PT370060	123
5-1393090-7	MT	MT223024	129	5-1393238-6	RT1 inrush	RTD1L012	44	5-1419135-6	PT	PT380615	123
5-1393090-8	MT	MT223048	129	5-1393238-7	RT1 bistable	RTD14F03	40	5-1419135-8	PT	PT380730	123
5-1393090-9	MT	MT223110	129	5-1393238-8	RT1 bistable	RTD14F12	40	5-1419135-9	PT	PT520524	123
5-1393091-9	MT	MT320012	129	5-1393238-9	RT1 dc/ac	RTD14005	37	5-1419136-2	RY II	RY613005	31
5-1393146-0	RM 2/3/7	RM302012	132	5-1393239-0	RT1 inrush	RT21L012	44	5-1419136-3	RY II	RY632005	31
5-1393146											

Part number reference list

Part No	Relay	Product key	Page	Part No	Relay	Product key	Page	Part No	Relay	Product key	Page
5-1419158-8	Card E	V23057-A0017-A101	74	6-1393234-4	RP II/2	RP421005	72	6-1419111-1	PT	PT370024	123
5-1440006-4	T7N/T7N-WG	T7NS1D1-12	84	6-1393234-5	RP II/2	RP421006	72	6-1419111-2	PT	PT370048	123
5-1440006-6	T7N/T7N-WG	T7NS1D1-24	84	6-1393234-6	RP II/2	RP421009	72	6-1419111-3	PT	PT370110	123
5-1440006-8	T7N/T7N-WG	T7NS1D1-48	84	6-1393234-7	RP II/2	RP421012	72	6-1419111-4	PT	PT370220	123
5-1461059-5	PCLH	PCLH-203D1SP	157	6-1393234-8	RP II/2	RP421024	72	6-1419111-5	PT	PT370512	123
5-1461059-8	PCLH	PCLH-206A1SP	157	6-1393234-9	RP II/2	RP421048	72	6-1419111-6	PT	PT370524	123
5-1461068-0	PCLH	PCLH-203D1F	157	6-1393236-1	SNR	V23092-A1912-A301	28	6-1419111-7	PT	PT370548	123
5-1461068-8	PCLH	PCLH-206A1S	157	6-1393236-2	SNR	V23092-A1912-A302	28	6-1419111-8	PT	PT370615	123
6-1393090-0	MT	MT223220	129	6-1393236-5	SNR	V23092-A1924-A302	28	6-1419111-9	PT	PT370730	123
6-1393090-1	MT	MT224024	129	6-1393236-8	SNR	V23092-B1005-A301	28	6-1419135-0	PT	PT520730	123
6-1393090-2	MT	MT226006	129	6-1393236-9	SNR	V23092-B1012-A201	28	6-1419135-1	PT	PT530024	123
6-1393090-3	MT	MT226012	129	6-1393238-0	RT1 dc/ac	RTD14006	37	6-1419135-9	PT	PT580220	123
6-1393090-4	MT	MT226024	129	6-1393238-1	RT1 dc/ac	RTD14009	37	6-1419137-6	IF	V23077-C1007-A402	61
6-1393090-5	MT	MT226048	129	6-1393238-2	RT1 dc/ac	RTD14012	37	6-1419149-5	MT	MT3B1110	129
6-1393090-6	MT	MT226060	129	6-1393238-4	RT1 dc/ac	RTD14015	37	6-1419149-6	Acc. MT	MTMG0024	158
6-1393090-7	MT	MT226115	129	6-1393238-5	RT1 dc/ac	RTD14018	37	6-1419149-7	Acc. MT	MTMG0730	158
6-1393090-8	MT	MT226230	129	6-1393238-6	RT1 dc/ac	RTD14020	37	6-1419151-0	RP II/2	RP820A05	72
6-1393090-9	MT	MT228024	129	6-1393238-8	RT1 dc/ac	RTD14024	37	6-1419151-2	RP II/2	RP820A48	72
6-1393091-0	MT	MT320024	129	6-1393238-9	RT1 dc/ac	RTD14048	37	6-1419151-4	RP II/2	RP820F60	72
6-1393091-1	MT	MT320048	129	6-1393239-0	RT1 dc/ac	RT214615	37	6-1419151-6	RP II/2	RP821A06	72
6-1393091-2	MT	MT320060	129	6-1393239-1	RT1 dc/ac	RT215012	37	6-1419151-7	RP II/2	RP821B10	72
6-1393091-4	MT	MT3210B2	129	6-1393239-2	RT1 dc/ac	RT215024	37	6-1419151-9	RP II/2	RP821F24	72
6-1393091-5	MT	MT3210C4	129	6-1393239-3	RT1 dc/ac	RT215110	37	6-1419158-8	IF	V23077-C1005-A402	61
6-1393091-7	MT	MT321006	129	6-1393239-4	RT1 dc/ac	RT215730	37	6-1440005-2	T7N/T7N-WG	T7NS1D4-06	84
6-1393091-8	MT	MT321012	129	6-1393239-5	RT1 dc/ac	RT234012	37	6-1440006-1	T7N/T7N-WG	T7NS5D4-06	84
6-1393098-2	UUB	V23148-B1007-A101	77	6-1393239-6	RT1 dc/ac	RT234024	37	6-1440006-3	T7N/T7N-WG	T7NS5D4-12	84
6-1393107-1	RM 2/3/7	RM335730	132	6-1393239-7	RT1 dc/ac	RT234048	37	6-1440006-5	T7N/T7N-WG	T7NS5D4-24	84
6-1393107-2	RM 2/3/7	RM339730	132	6-1393239-8	RT1 sensitive	RT274012	42	6-1440006-6	T7N/T7N-WG	T7NS5D4-36	84
6-1393146-0	RM 2/3/7	RM332110	132	6-1393239-9	RT1 sensitive	RT274024	42	6-1440006-7	T7N/T7N-WG	T7NS5D4-48	84
6-1393146-1	RM 5/6	RM502024	136	6-1393243-1	RT2 dc/ac	RT424006	67	6-1461059-0	PCLH	PCLH-208A1SP	157
6-1393146-2	RM 5/6	RM502524	136	6-1393243-2	RT2 dc/ac	RT424009	67	6-1461059-3	PCLH	PCLH-203A1SP	157
6-1393146-3	RM 5/6	RM502615	136	6-1393243-3	RT2 dc/ac	RT424012	67	6-1461068-3	PCLH	PCLH-203A1S	157
6-1393146-4	RM 5/6	RM502730	136	6-1393243-5	RT2 dc/ac	RT424015	67	7-1393090-0	MT	MT228115	129
6-1393146-5	RM 5/6	RM503615	136	6-1393243-6	RT2 dc/ac	RT424018	67	7-1393090-1	MT	MT228230	129
6-1393146-6	RM 5/6	RM505615	136	6-1393243-7	RT2 dc/ac	RT424020	67	7-1393090-2	MT	MT231024	129
6-1393146-7	RM 5/6	RM505720	136	6-1393243-8	RT2 dc/ac	RT424024	67	7-1393090-4	MT	MT236115	129
6-1393146-8	RM 5/6	RM507012	136	6-1393243-9	RT2 dc/ac	RT424036	67	7-1393090-5	MT	MT236230	129
6-1393146-9	RM 5/6	RM507110	136	6-1393250-3	W28	W28-XT1A-10	167	7-1393091-0	MT	MT321024	129
6-1393148-3	RM 2/3/7	RM303012	132	6-1393250-5	W28	W28-XT1A-15	167	7-1393091-1	MT	MT321048	129
6-1393148-4	RM 2/3/7	RM303024	132	6-1393252-2	W6	W67-XQ212-5	171	7-1393091-2	MT	MT321060	129
6-1393161-5	Acc. RY	RY16037	148	6-1415001-1	PT	PT570L24	123	7-1393091-3	MT	MT3211B0	129
6-1393161-6	Acc. RY	RY16038	148	6-1415003-1	RM 2/3/7	RM732M10	132	7-1393091-4	MT	MT321110	129
6-1393161-7	Acc. RY	RY16039	148	6-1415011-1	SR2 M	V23047-A1006-A511	102	7-1393091-5	MT	MT321125	129
6-1393161-8	Acc. RY	RY16040	148	6-1415012-1	MT	MT223125	129	7-1393091-6	MT	MT3212C0	129
6-1393211-0	T92	T92P7A22-24	90	6-1415013-1	MT	MT321250	129	7-1393091-7	MT	MT321220	129
6-1393211-2	T92	T92P7A22-240	90	6-1415014-1	SR6	V23050-A1015-A542	110	7-1393091-8	MT	MT3230B2	129
6-1393211-3	T92	T92P7A22-277	90	6-1415015-1	RM 5/6	RM507615	136	7-1393091-9	MT	MT3230C4	129
6-1393211-5	T92	T92P7D12-12	90	6-1415017-1	SR6	V23050-A1018-A551	110	7-1393107-4	RM 5/6	RM632012	136
6-1393211-9	T92	T92P7D22-12	90	6-1415018-1	SR6	V23050-A1048-A533	110	7-1393107-7	RM 5/6	RM635024	136
6-1393215-0	Card E	V23057-A0028-A401	74	6-1415020-1	RT1 dc/ac	RT315615	37	7-1393146-1	RM 5/6	RM532L4C	136
6-1393215-6	Card E	V23057-B0001-A101	74	6-1415024-1	Acc. SNR	ST16016	147	7-1393146-2	RM 5/6	RM535024	136
6-1393215-7	Card E	V23057-B0002-A101	74	6-1415025-1	PNR Package	ST1P2L24	164	7-1393146-3	RM 5/6	RM537L24	136
6-1393215-8	Card E	V23057-B0002-A102	74	6-1415026-1	PT	PT580R24	123	7-1393146-4	RM 5/6	RM5390C4	136
6-1393215-9	Card E	V23057-B0002-A201	74	6-1415027-1	SR6 D/M	SR6D4024	108	7-1393146-5	RM 5/6	RM602221	136
6-1393222-1	MSR	V23061-A1010-A402	34	6-1415029-1	PB	PB114005	82	7-1393146-6	RM 5/6	RM605730	136
6-1393222-2	MSR	V23061-A1010-A502	34	6-1415030-1	PB	PB314012	82	7-1393146-7	RM 5/6	RM607012	136
6-1393222-3	MSR	V23061-A1010-A602	34	6-1415031-1	PT	PT580N20	123	7-1393146-8	RM 5/6	RM607524	136
6-1393222-5	MSR	V23061-A1013-A402	34	6-1415032-1	RP3SL	RP3SLA15	55	7-1393146-9	RM 5/6	RM607730	136
6-1393222-6	MSR	V23061-A1014-A302	34	6-1415033-1	SR6 Z	SR6ZB036	116	7-1393148-1	RM 2/3/7	RM307006	132
6-1393222-7	MSR	V23061-A1015-A302	34	6-1415034-1	Acc. PT	PT78720	154	7-1393148-2	RM 2/3/7	RM307024	132
6-1393222-8	MSR	V23061-A2002-A402	34	6-1415035-1	Acc. RT	RT78726	150	7-1393148-7	RM 2/3/7	RM338730	132
6-1393222-9	MSR	V23061-B1001-A401	34	6-1415036-1	A. PT,RP,RT	PTML0524	150	7-1393148-8	RM 5/6	RM502012	136
6-1393224-0	RY II	RY213005	31	6-1415037-1	Acc. PT	PT17040	154	7-1393161-1	Acc. RY	RY16046	148
6-1393224-1	RY II	RY213012	31	6-1415043-1	Acc. PT	PT78601	154	7-1393161-3	Acc. RY	RY78600	148
6-1393224-2	RY II	RY213024	31	6-1415046-1	SR6 Z	SR6ZB615	116	7-1393161-4	Acc. RY	RY78602	148
6-1393224-3	RY II	RY213048	31	6-1415048-1	PT	PT580125	123	7-1393161-5	Acc. RY	RY78613	148
6-1393224-4	RY II	RY230048	31	6-1415053-1	SR4 D/M	SR4M4006	105	7-1393161-8	Acc. RY	RY78626	148
6-1393224-6	RY II	RY530005	31	6-1415054-1	SR4 D/M	SR4M4110	105	7-1393163-3	Acc. MT	MTMF0W00	158
6-1393224-7	RY II	RY530006	31	6-1415055-1	SR4 D/M	SR4D4048	105	7-1393163-4	Acc. MT	MTML0024	158
6-1393224-8	RY II	RY530009	31	6-1415056-1	SR6sensitive	SR6B4S24	113	7-1393163-5	Acc. MT	MTML0730	158
6-1393224-9	RY II	RY530012	31	6-1415057-1	SR6sensitive	SR6A4S24	113	7-1393163-6	Acc. MT	MTMT00A0	158
6-1393230-0	RP II/1	RP350024	52	6-1415058-1	SR6sensitive	SR6C4S24	113	7-1393163-7	Acc. MT	MTMU0524	158
6-1393230-1	RP II/1	RP350048	52	6-1415060-1	SR6 Z	SR6ZC730	116	7-1393163-8	Acc. MT	MTMU0730	158
6-1393230-2	RP II/1	RP41A012	52	6-1415064-1	SR6 Z	SR6ZA048	116	7-1393163-9	Acc. MT	MTMZ0W00	158
6-1393230-3	RP II/1	RP41A024	52	6-1415073-1	RT Package	RT3S4T30	165	7-1393211-1	T92	T92P7D22-24	90
6-1393230-4	RP II/1	RP41A060	52	6-1415074-1	PT Package	PT2S7TD0	166	7-1393211-4	T92	T92P7D32-24	90
6-1393230-5	RP II/1	RP41A110	52	6-1415075-1	PT Package	PT5S8LC4	166	7-1393215-0	Card E	V23057-B0002-A202	74
6-1393230-6	RP II/1	RP41A1730	52	6-1415429-4	429 Inrush	0429 03 0310 00	46	7-1393215-1	Card E	V23057-B0002-A401	74
6-1393230-7	RP II/1	RP41B009	52	6-1415429-5	429 Inrush	0429 03 0312 00	46	7-1393215-2	Card E	V23057-B0002-A402	74
6-1393230-8	RP II/1	RP41B012	52	6-1415429-6	429 Inrush	0429 03 0510 00	46	7-1393215-4	Card E	V23057-B0002-B101	74
6-1393230-9	RP II/1	RP41B024	52	6-1415429-7	429 Inrush	0429 03 0512 00	46	7-1393215-5	Card E	V23057-B0006-A101	74
6-1393231-4	RP3SL	RP7SLA12	55	6-1415429-8	429 Inrush	0429 03 0612 00	46	7-1393215-9	Card E	V23057-B0006-A102	74
6-1393231-5	RP3SL	RP7SL012	55	6-1415429-9	429 Inrush	0429 03 0810 00	46	7-1393222-1	MSR	V23061-B1002-A201	34
6-1393231-6	RP3SL	RP7SL024	55	6-1415430-0	430 3mm	0430 15 1011 00	93	7-1393222-2	MSR	V23061-B1002-A301	34
6-1393231-7	RP3SL	RP7SL048	55	6-1415430-1	430 3mm	0430 15 1111 00	93	7-1393222-3	MSR	V23061-B1002-A401	34
6-1393231-8	RP II/1	RP71DA24	52	6-1415430-2	430 3mm	0430 15 2611 00	93	7-1393222-4	MSR	V23061-B1002-A501	34
6-1393231-9	RP II/1	RP710F12	52	6-1415430-3	430 3mm	0430 15 2711 00	93	7-1393222-5	MSR	V23061-B1002-A601	34

Part number reference list

Part No	Relay	Product key	Page	Part No	Relay	Product key	Page	Part No	Relay	Product key	Page
7-1393224-8	RY II	RY531009	31	7-1415032-1	PT	PT520110	123	8-1393163-0	Acc. MT	MT28800	158
7-1393224-9	RY II	RY531012	31	7-1415033-1	SR6 Z	SR6ZA024	116	8-1393163-4	Acc. MT	MT78740	158
7-1393225-7	RY II	RYA30048	31	7-1415036-1	A. PT,RP,RT	PTML0730	150	8-1393163-3	Acc. MT	MT78745	158
7-1393230-0	RP II/1	RP41B048	52	7-1415037-1	Acc. PT	PT17017	154	8-1393211-4	T92	T92S11A22-120	90
7-1393230-1	RP II/1	RP41B110	52	7-1415043-1	Acc. MT	MT78612	158	8-1393211-7	T92	T92S11A22-240	90
7-1393230-2	RP II/1	RP41B730	52	7-1415045-1	RT1 dc/ac	RT115615	37	8-1393211-9	T92	T92S11D12-12	90
7-1393230-3	RP II/1	RP410A05	52	7-1415048-1	RT2 bistable	RT423F24	70	8-1393215-1	Card E	V23057-B0006-A201	74
7-1393230-4	RP II/1	RP410A12	52	7-1415053-1	SR4 D/M	SR4M4009	105	8-1393215-3	Card E	V23057-B0006-A202	74
7-1393230-5	RP II/1	RP410A24	52	7-1415054-1	SR4 D/M	SR4D4005	105	8-1393215-5	Card E	V23057-B0006-A401	74
7-1393230-6	RP II/1	RP410F05	52	7-1415055-1	SR4 D/M	SR4D4060	105	8-1393215-6	Card E	V23057-B0006-A402	74
7-1393230-7	RP II/1	RP410F12	52	7-1415056-1	SR6sensitive	SR6B4S36	113	8-1393215-7	Card E	V23057-B0006-A501	74
7-1393230-8	RP II/1	RP410F24	52	7-1415057-1	SR6sensitive	SR6A4S36	113	8-1393215-9	Card E	V23057-B0006-B101	74
7-1393230-9	RP II/1	RP410005	52	7-1415058-1	SR6sensitive	SR6C4S36	113	8-1393222-1	MSR	V23061-B1003-A501	34
7-1393231-0	RP II/1	RP710005	52	7-1415060-1	MT	MT3B1060	129	8-1393222-2	MSR	V23061-B1003-A601	34
7-1393231-1	RP II/1	RP710006	52	7-1415063-1	PE	PE014A05	22	8-1393222-6	MSR	V23061-B1004-A401	34
7-1393231-2	RP II/1	RP710012	52	7-1415064-1	SR6 Z	SR6ZC048	116	8-1393222-8	MSR	V23061-B1004-A501	34
7-1393231-3	RP II/1	RP710015	52	7-1415073-1	RT Package	RT3S5LC4	165	8-1393222-9	MSR	V23061-B1004-A601	34
7-1393231-4	RP II/1	RP710018	52	7-1415074-1	PT Package	PT2S7LB2	166	8-1393224-0	RY II	RY531015	31
7-1393231-5	RP II/1	RP710024	52	7-1415075-1	PT Package	PT5S7RC4	166	8-1393224-1	RY II	RY531018	31
7-1393231-6	RP II/1	RP710048	52	7-1415077-1	RTH	RTHH4009	50	8-1393224-2	RY II	RY531024	31
7-1393231-7	RP II/1	RP710060	52	7-1415429-0	429 Inrush	0429 03 0812 00	46	8-1393224-3	RY II	RY531048	31
7-1393231-8	RP II/1	RP710730	52	7-1415429-1	429 Inrush	0429 03 1012 00	46	8-1393224-4	RY II	RY532012	31
7-1393231-9	RP II/1	RP730A12	52	7-1415429-2	429 Inrush	0429 03 1310 00	46	8-1393224-5	RY II	RY532024	31
7-1393233-0	RP II/2	RP440615	72	7-1415429-3	429 Inrush	0429 03 1311 01	46	8-1393224-6	RY II	RY533006	31
7-1393233-1	RP II/2	RP441005	72	7-1415429-4	429 Inrush	0429 03 1312 00	46	8-1393224-7	RY II	RY533009	31
7-1393233-3	RP II/1	RP450730	52	7-1415429-5	429 Inrush	0429 03 1410 00	46	8-1393224-8	RY II	RY533012	31
7-1393233-7	RP3SL	RP7SLA05	55	7-1415429-6	429 Inrush	0429 03 1610 00	46	8-1393224-9	RY II	RY533024	31
7-1393233-8	RP3SL	RP7SLA06	55	7-1415429-7	429 Inrush	0429 03 1612 00	46	8-1393230-0	RP II/1	RP410006	52
7-1393233-9	RP3SL	RP7SLA08	55	7-1415429-8	429 Inrush	0429 03 5810 00	46	8-1393230-1	RP II/1	RP410012	52
7-1393234-0	RP II/2	RP421060	72	7-1415429-9	429 Inrush	0429 03 6210 00	46	8-1393230-2	RP II/1	RP410024	52
7-1393234-1	RP II/2	RP421110	72	7-1415430-0	430 1/2pole	0430 16 0311 00	96	8-1393230-3	RP II/1	RP410048	52
7-1393234-2	RP II/2	RP421615	72	7-1415430-1	430 1/2pole	0430 16 0313 00	96	8-1393230-4	RP II/1	RP410060	52
7-1393234-3	RP II/2	RP421F12	72	7-1415430-2	430 1/2pole	0430 16 0602 00	96	8-1393230-5	RP II/1	RP410110	52
7-1393234-4	RP II/2	RP421F24	72	7-1415430-3	430 1/2pole	0430 16 0701 00	96	8-1393230-6	RP II/1	RP410524	52
7-1393234-5	RP II/2	RP427024	72	7-1415430-4	430 1/2pole	0430 16 0702 00	96	8-1393230-7	RP II/1	RP410615	52
7-1393234-6	RP II/2	RP427615	72	7-1415430-5	430 1/2pole	0430 16 0703 00	96	8-1393230-8	RP II/1	RP410730	52
7-1393234-7	RP II/2	RP42A012	72	7-1415430-6	430 1/2pole	0430 16 0703 01	96	8-1393230-9	RP II/1	RP411A12	52
7-1393234-8	RP II/2	RP440012	72	7-1415430-7	430 1/2pole	0430 16 0703 04	96	8-1393231-0	RP II/1	RP730F06	52
7-1393234-9	RP II/2	RP440024	72	7-1415430-8	430 1/2pole	0430 16 0713 00	96	8-1393231-1	RP II/1	RP730F12	52
7-1393236-0	SNR	V23092-B1012-A202	28	7-1415430-9	430 1/2pole	0430 16 0903 00	96	8-1393231-2	RP II/1	RP730012	52
7-1393236-1	SNR	V23092-B1012-A301	28	7-1419111-0	PT	PT371012	123	8-1393231-3	RP II/1	RP730020	52
7-1393236-2	SNR	V23092-B1024-A201	28	7-1419111-1	PT	PT371024	123	8-1393231-4	RP II/1	RP730024	52
7-1393236-3	SNR	V23092-B1024-A202	28	7-1419111-2	PT	PT371110	123	8-1393231-5	RP II/1	RP730036	52
7-1393236-4	SNR	V23092-B1024-A301	28	7-1419111-3	PT	PT371524	123	8-1393231-6	RP II/1	RP730048	52
7-1393236-5	SNR	V23092-B1024-A302	28	7-1419111-4	PT	PT371548	123	8-1393231-7	RP II/1	RP730110	52
7-1393236-6	SNR	V23092-B1060-A201	28	7-1419111-5	PT	PT371730	123	8-1393231-8	RP II/1	RP81A024	52
7-1393236-7	SNR	V23092-B1905-A201	28	7-1419111-6	PT	PT520024	123	8-1393231-9	RP II/1	RP81B024	52
7-1393238-1	RT1 dc/ac	RTD14060	37	7-1419111-7	PT	PT521012	123	8-1393233-0	RP3SL	RP7SLA24	55
7-1393238-2	RT1 dc/ac	RTD14110	37	7-1419111-8	PT	PT521024	123	8-1393233-2	RP II/1	RP710A12	52
7-1393238-3	RT1 dc/ac	RTD14524	37	7-1419111-9	PT	PT570006	123	8-1393233-3	RP II/1	RP710A24	52
7-1393238-5	RT1 dc/ac	RTD14615	37	7-1419135-2	PT	PT581024	123	8-1393233-4	RP II/1	RP710F24	52
7-1393238-7	RT1 dc/ac	RTD14730	37	7-1419142-8	RP II/1	RP431090	52	8-1393233-5	RP II/1	RP710009	52
7-1393238-9	RT1 dc/ac	RTD15012	37	7-1419142-9	RP II/1	RP431W21	52	8-1393233-7	RP II/1	RP710524	52
7-1393239-0	RT1 inrush	RT31K012	44	7-1419150-8	RP II/1	RP330A06	52	8-1393233-8	RP II/1	RP710615	52
7-1393239-1	RT1 inrush	RT31K024	44	7-1419151-0	RP II/2	RP827060	72	8-1393234-0	RP II/2	RP441024	72
7-1393239-2	RT1 inrush	RT31L006	44	7-1440006-2	T7N/T7N-WG	T7NS1D4-12	84	8-1393234-3	Acc. RP	RP78600	150
7-1393239-3	RT1 inrush	RT31L012	44	7-1440006-4	T7N/T7N-WG	T7NS1D4-24	84	8-1393234-4	Acc. RP	RP78601	150
7-1393239-4	RT1 inrush	RT31L018	44	7-1440006-5	T7N/T7N-WG	T7NS1D4-36	84	8-1393234-5	Acc. RP	RP78602	150
7-1393239-5	RT1 inrush	RT31L024	44	7-1440006-6	T7N/T7N-WG	T7NS1D4-48	84	8-1393234-6	Acc. RP	RP78623	150
7-1393239-6	RT1 inrush	RT31L048	44	7-1440006-8	T7N/T7N-WG	T7NS1H1-12-WG-A	84	8-1393234-7	RP II/2	RP820005	72
7-1393239-7	RT1 bistable	RT314A03	40	7-1440006-9	T7N/T7N-WG	T7NS5H1-06-WG-A	84	8-1393234-8	RP II/2	RP820006	72
7-1393239-8	RT1 bistable	RT314A05	40	7-1440007-1	PCLH	PCLH-203D1S	157	8-1393234-9	RP II/2	RP820009	72
7-1393239-9	RT1 bistable	RT314A06	40	7-1440007-5	PCLH	PCLH-208A1S	157	8-1393236-0	SNR	V23092-B1905-A202	28
7-1393243-0	RT2 dc/ac	RT424048	67	8-1393090-9	MT	MT3B30C4	129	8-1393236-1	SNR	V23092-B1905-A302	28
7-1393243-2	RT2 dc/ac	RT424052	67	8-1393091-3	MT	MT323012	129	8-1393236-2	SNR	V23092-B1924-A302	28
7-1393243-3	RT2 dc/ac	RT424060	67	8-1393091-4	MT	MT323024	129	8-1393238-0	RT1 dc/ac	RTD15024	37
7-1393243-4	RT2 dc/ac	RT424080	67	8-1393091-5	MT	MT323048	129	8-1393238-1	RT1 inrush	RTD3KA05	44
7-1393243-5	RT2 dc/ac	RT424110	67	8-1393091-6	MT	MT323060	129	8-1393238-2	RT1 bistable	RTD3A005	40
7-1393243-6	RT2 dc/ac	RT424524	67	8-1393091-7	MT	MT3231B0	129	8-1393238-3	RT1 dc/ac	RTD34005	37
7-1393243-7	RT2 dc/ac	RT424548	67	8-1393091-9	MT	MT323110	129	8-1393238-4	RT1 dc/ac	RTD34015	37
7-1393243-8	RT2 dc/ac	RT424615	67	8-1393096-4	MT	MT321036	129	8-1393238-5	RT1 dc/ac	RTD34048	37
7-1393243-9	RT2 dc/ac	RT424730	67	8-1393096-6	MT	MT326110	129	8-1393238-6	RT1 dc/ac	RTD34524	37
7-1393250-1	W28	W28-XT1A-6	167	8-1393146-0	RM 5/6	RM632024	136	8-1393238-7	RT1 dc/ac	RTD34615	37
7-1393250-8	W28	W28-X1024-3.20	167	8-1393146-1	RM 5/6	RM632110	136	8-1393238-8	RT1 dc/ac	RTD34730	37
7-1393252-0	W6	W67-X2Q13-25	171	8-1393146-2	RM 5/6	RM635012	136	8-1393239-0	RT1 bistable	RT314A12	40
7-1415001-1	PT	PT570R24	123	8-1393146-3	RM 2/3/7	RM702L24	132	8-1393239-1	RT1 bistable	RT314A24	40
7-1415002-1	PT	PT370R24	123	8-1393146-4	RM 2/3/7	RM7020C4	132	8-1393239-3	RT1 bistable	RT314A48	40
7-1415003-1	PT	PT570S15	123	8-1393146-5	RM 2/3/7	RM702024	132	8-1393239-4	RT1 bistable	RT314F03	40
7-1415006-1	SR2 M	V23047-A1005-A511	102	8-1393146-6	RM 2/3/7	RM702110	132	8-1393239-5	RT1 bistable	RT314F05	40
7-1415008-1	MT	MT3B31B0	129	8-1393146-7	RM 2/3/7	RM702221	132	8-1393239-6	RT1 bistable	RT314F06	40
7-1415011-1	SR2 M	V23047-A1009-A511	102	8-1393146-8	RM 2/3/7	RM702627	132	8-1393239-7	RT1 bistable	RT314F12	40
7-1415012-1	MT	MT226110	129	8-1393146-9	RM 2/3/7	RM702720	132	8-1393239-8	RT1 bistable	RT314F24	40
7-1415013-1	MT	MT323125	129	8-1393147-7	RMC/RMD	RMC05615	143	8-1393239-9	RT1 bistable	RT314F36	40
7-1415014-1	RT1 inrush	RT31LA24	44	8-1393148-0	RM 5/6	RM503024	136	8-1393243-0	RT2 dc/ac	RT425005	67
7-1415015-1	RM 5/6	RM602110	136	8-1393148-2	RM 5/6	RM505012	136	8-1393243-1	RT2 dc/ac	RT425006	67
7-1415017-1	SR6	V23050-A1021-A551	110	8-1393148-3	RM 5/6	RM505024	136	8-1393243-2	RT2 dc/ac	RT425012	67
7-1415018-1	SR6	V23050-A1060-A533	110	8-1393148-4	RM 5/6	RM507048					

Part number reference list

Part No	Relay	Product key	Page	Part No	Relay	Product key	Page	Part No	Relay	Product key	Page
8-1415006-1	RTH	RTH14012	50	9-1393148-4	RM 5/6	RM602048	136	9-1415024-1	Acc. SNR	ST17010	147
8-1415011-1	SR2 M	V23047-A1036-A511	102	9-1393148-7	RM 5/6	RM602615	136	9-1415025-1	PT	PT280L24	123
8-1415013-1	MT	MT323250	129	9-1393149-2	RM 2/3/7	RM332024	132	9-1415027-1	RT1 inrush	RT33K060	44
8-1415014-1	RT1 inrush	RT31LF24	44	9-1393149-3	RM 2/3/7	RM332524	132	9-1415029-1	PB	PB114024	82
8-1415015-1	RM 5/6	RM607615	136	9-1393149-4	RM 2/3/7	RM332730	132	9-1415030-1	PB	PB334006	82
8-1415017-1	SR6	V23050-A1005-A533	110	9-1393149-5	RM 2/3/7	RM332880	132	9-1415033-1	MT	MT320110	129
8-1415018-1	SR6	V23050-A1085-A533	110	9-1393149-6	RM 2/3/7	RM333024	132	9-1415036-1	A. PT,RP,RT	PTMT00A0	150
8-1415022-1	RY II	RY612060	31	9-1393149-9	RM 5/6	RM505730	136	9-1415037-1	Acc. PT	PT17019	154
8-1415024-1	Acc. SNR	ST17005	147	9-1393211-0	T92	T92S11D12-24	90	9-1415039-1	PT	PT370S15	123
8-1415025-1	MT	MT338115	129	9-1393211-1	T92	T92S11D12-48	90	9-1415040-1	SR6	SR6F4048	110
8-1415026-1	PT	PT370125	123	9-1393211-3	T92	T92S11D22-12	90	9-1415043-1	Acc. MT	MT78602	158
8-1415027-1	RM 5/6	RM5070A6	136	9-1393211-4	T92	T92S11D22-24	90	9-1415044-1	RM 2/3/7	RM2030C4	132
8-1415028-1	SR6	SR6F4012	110	9-1393211-7	T92	T92S7A12-120	90	9-1415047-1	RTH	RTHH4024	50
8-1415029-1	PB	PB114012	82	9-1393211-9	T92	T92S7A12-240	90	9-1415052-1	SR6 Z	SR6ZB048	116
8-1415030-1	PB	PB334005	82	9-1393215-0	Card E	V23057-B0006-B601	74	9-1415053-1	SR4 D/M	SR4M4018	105
8-1415031-1	PT	PT380110	123	9-1393215-3	Card E	V23057-B0008-A201	74	9-1415054-1	SR4 D/M	SR4D4009	105
8-1415034-1	Acc. MT	MT78760	158	9-1393215-4	Card E	V23057-B0013-A101	74	9-1415055-1	SR4 D/M	SR4D4110	105
8-1415035-1	Acc. RT	RT78724	150	9-1393215-5	Card E	V23057-B0013-A201	74	9-1415056-1	SR6sensitive	SR6B4S48	113
8-1415036-1	A. PT,RP,RT	PTML1024	150	9-1393215-6	Card E	V23057-B0013-A401	74	9-1415057-1	SR6sensitive	SR6A4S48	113
8-1415037-1	Acc. PT	PT17018	154	9-1393215-7	Card E	V23057-B0013-A901	74	9-1415058-1	SR6sensitive	SR6C4S48	113
8-1415039-1	PT	PT571006	123	9-1393215-8	Card E	V23057-B0013-B101	74	9-1415059-1	SR6 Z	SR6ZA524	116
8-1415043-1	Acc. MT	MT78613	158	9-1393222-1	MSR	V23061-B1005-A301	34	9-1415063-1	PE	PE014A24	22
8-1415047-1	RTH	RTHH4012	50	9-1393222-4	MSR	V23061-B1005-A401	34	9-1415067-1	SNR	V23092-A1005-A302	28
8-1415048-1	RT1 sensitive	RTB84018	42	9-1393222-7	MSR	V23061-B1005-A501	34	9-1415071-1	Acc. PT	PT78730	154
8-1415053-1	SR4 D/M	SR4M4012	105	9-1393222-9	MSR	V23061-B1005-A601	34	9-1415073-1	RT Package	RT3S5T30	165
8-1415054-1	SR4 D/M	SR4D4006	105	9-1393224-0	RY II	RY533048	31	9-1415074-1	PT Package	PT3S7RC4	166
8-1415055-1	SR4 D/M	SR4D4085	105	9-1393224-1	RY II	RY550005	31	9-1415075-1	PT Package	PT5S7LB2	166
8-1415056-1	SR6sensitive	SR6B4S40	113	9-1393224-2	RY II	RY550006	31	9-1415430-0	430 1/2pole	0430 16 6703 05	96
8-1415057-1	SR6sensitive	SR6A4S40	113	9-1393224-3	RY II	RY550009	31	9-1415430-1	430 1/2pole	0430 17 0206 08	96
8-1415058-1	SR6sensitive	SR6C4S40	113	9-1393224-4	RY II	RY550012	31	9-1415430-2	430 1/2pole	0430 17 0306 00	96
8-1415063-1	PE	PE014A12	22	9-1393224-5	RY II	RY550018	31	9-1415430-3	430 1/2pole	0430 17 0604 00	96
8-1415067-1	SNR	V23092-A1005-A202	28	9-1393224-6	RY II	RY550024	31	9-1415430-4	430 1/2pole	0430 17 0606 00	96
8-1415073-1	RT Package	RT3S5R24	165	9-1393224-7	RY II	RY550048	31	9-1415430-5	430 1/2pole	0430 17 0706 00	96
8-1415074-1	PT Package	PT2S7LC4	166	9-1393224-8	RY II	RY550055	31	9-1415430-6	430 1/2pole	0430 17 0706 02	96
8-1415075-1	PT Package	PT5S7TD0	166	9-1393224-9	RY II	RY551012	31	9-1415430-7	430 1/2pole	0430 17 0706 06	96
8-1415429-0	429 Inrush	0429 03 9910 03	46	9-1393230-0	RP II/1	RP411F12	52	9-1415430-8	430 1/2pole	0430 17 0716 00	96
8-1415430-0	430 1/2pole	0430 16 0903 02	96	9-1393230-1	RP II/1	RP411F24	52	9-1415430-9	430 1/2pole	0430 17 0716 07	96
8-1415430-1	430 1/2pole	0430 16 0911 00	96	9-1393230-2	RP II/1	RP411005	52	9-1419111-0	PT	PT570615	123
8-1415430-2	430 1/2pole	0430 16 1003 00	96	9-1393230-3	RP II/1	RP411006	52	9-1419111-1	PT	PT570730	123
8-1415430-3	430 1/2pole	0430 16 1011 00	96	9-1393230-4	RP II/1	RP411012	52	9-1419111-2	PT	PT571012	123
8-1415430-4	430 1/2pole	0430 16 1011 04	96	9-1393230-5	RP II/1	RP411024	52	9-1419111-3	PT	PT571024	123
8-1415430-5	430 1/2pole	0430 16 1013 00	96	9-1393230-6	RP II/1	RP411048	52	9-1419111-4	PT	PT571048	123
8-1415430-6	430 1/2pole	0430 16 3511 01	96	9-1393230-7	RP II/1	RP411060	52	9-1419111-5	PT	PT571110	123
8-1415430-7	430 1/2pole	0430 16 5703 06	96	9-1393230-8	RP II/1	RP411110	52	9-1419111-6	PT	PT571524	123
8-1415430-8	430 1/2pole	0430 16 6503 03	96	9-1393230-9	RP II/1	RP411524	52	9-1419111-7	PT	PT571548	123
8-1415430-9	430 1/2pole	0430 16 6603 03	96	9-1393231-0	RP II/1	RP81B110	52	9-1419111-8	PT	PT571730	123
8-1419082-5	RM 2/3/7	RM732012	132	9-1393231-1	RP II/1	RP810012	52	9-1419111-9	Acc. PT	PT78702	154
8-1419111-0	PT	PT570012	123	9-1393231-2	RP II/1	RP810024	52	9-1419143-5	RT1 sensitive	RT174009	42
8-1419111-1	PT	PT570048	123	9-1393231-3	RP II/1	RP810048	52	9-1419150-1	RP II/1	RP418A24	52
8-1419111-2	PT	PT570060	123	9-1393231-4	RP II/1	RP810615	52	9-1419150-2	RP II/1	RP418A48	52
8-1419111-3	PT	PT570110	123	9-1393231-5	RP II/1	RP810730	52	9-1419150-3	RP II/1	RP418A60	52
8-1419111-4	PT	PT570220	123	9-1393231-6	RP II/1	RP811A06	52	9-1419150-5	RP II/1	RP418F06	52
8-1419111-5	PT	PT570506	123	9-1393231-7	RP II/1	RP811F12	52	9-1419150-6	RP II/2	RP420512	72
8-1419111-6	PT	PT570512	123	9-1393231-8	RP II/1	RP811012	52	9-1419150-7	RP II/2	RP420A06	72
8-1419111-7	PT	PT570524	123	9-1393231-9	RP II/1	RP811024	52				
8-1419111-8	PT	PT570548	123	9-1393233-4	RP II/1	RP730615	52				
8-1419111-9	PT	PT570560	123	9-1393234-0	RP II/2	RP820012	72				
8-1419132-7	PT	PT270627	123	9-1393234-1	RP II/2	RP820018	72				
8-1419132-8	PT	PT570627	123	9-1393234-2	RP II/2	RP820024	72				
8-1419132-9	PT	PT580615	123	9-1393234-3	RP II/2	RP820048	72				
8-1419150-4	RP II/1	RP33D730	52	9-1393234-4	RP II/2	RP820060	72				
8-1419150-5	RP II/1	RP350060	52	9-1393234-5	RP II/2	RP820110	72				
8-1419150-8	RP II/1	RP35D048	52	9-1393234-6	RP II/2	RP820524	72				
8-1419151-3	RP II/2	RP841F05	72	9-1393234-7	RP II/2	RP820615	72				
8-1419151-4	RP II/2	RP847024	72	9-1393234-8	RP II/2	RP820730	72				
8-1440006-0	T7N/T7N-WG	T7NS5H1-12-WG-A	84	9-1393234-9	RP II/2	RP820A24	72				
8-1440006-1	T7N/T7N-WG	T7NS5H1-18-WG-A	84	9-1393238-0	RTHsensitive	RTH84006	48				
8-1440006-2	T7N/T7N-WG	T7NS5H1-24-WG-A	84	9-1393238-1	RTHsensitive	RTH84010	48				
8-1440006-3	T7N/T7N-WG	T7NS5H1-36-WG-A	84	9-1393238-2	RTHsensitive	RTH84012	48				
8-1440006-4	T7N/T7N-WG	T7NS5H1-48-WG-A	84	9-1393238-3	RTHsensitive	RTH84024	48				
9-1393090-1	MT	MT3B3024	129	9-1393239-0	RT1 dc/ac	RT314003	37				
9-1393090-3	MT	MT3B6115	129	9-1393239-1	RT1 dc/ac	RT314005	37				
9-1393090-4	MT	MT3B6230	129	9-1393239-3	RT1 dc/ac	RT314006	37				
9-1393090-5	MT	MT3B8024	129	9-1393239-4	RT1 dc/ac	RT314009	37				
9-1393090-7	MT	MT3B8230	129	9-1393239-5	RT1 dc/ac	RT314012	37				
9-1393091-0	MT	MT3232C0	129	9-1393239-6	RT1 dc/ac	RT314015	37				
9-1393091-1	MT	MT323220	129	9-1393239-7	RT1 dc/ac	RT314018	37				
9-1393091-5	MT	MT326006	129	9-1393239-8	RT1 dc/ac	RT314024	37				
9-1393091-6	MT	MT326012	129	9-1393243-0	RT2 dc/ac	RT425110	67				
9-1393091-7	MT	MT326024	129	9-1393243-1	RT2 dc/ac	RT425524	67				
9-1393091-8	MT	MT326048	129	9-1393243-2	RT2 dc/ac	RT425615	67				
9-1393091-9	MT	MT326060	129	9-1393243-3	RT2 dc/ac	RT425730	67				
9-1393107-1	RM 2/3/7	RM732T30	132	9-1393243-4	RT2 dc/ac	RT443730	67				
9-1393107-2	RM 2/3/7	RM732221	132	9-1393243-5	RT2 dc/ac	RT444005	67				
9-1393107-5	RM 2/3/7	RM739012	132	9-1393243-6	RT2 dc/ac	RT444006	67				
9-1393146-0	RM 2/3/7	RM702880	132	9-1393243-7	RT2 dc/ac	RT444012	67				
9-1393146-1	RM 2/3/7	RM703524	132	9-1393243-9	RT2 dc/ac	RT444024	67				
9-1393146-2	RM 2/3/7	RM703615	132	9-1415001-1	PT	PT270L24	123				
9-1393146-3	RM 2/3/7	RM703720	132	9-1415002-1	PT	PT370T30	123				
9-1393146-4	RM 2/3/7	RM703730	132	9-1415006-1	RTH	RTH34012	50				
9-1393146-5	RM 2/3/7	RM705012	132	9-1415008-1	PT	PT280048	123				
9-1393146-6	RM 2/3/7	RM705024	132	9-1415011-1	SR2 M	V23047-A1048-A511	102				
9-1393146-7	RM 2/3/7	RM705524	132	9-1415013-1	MT	MT326127	129				
9-1393146-8	RM 2/3/7	RM707024	132	9-1415017-1	SR6	V23050-A1006-A533	110				
9-1393146-9	RM 2/3/7	RM707110	132	9-1415018-1	SR6	V23050-A1110-A533	110				

© Tyco Electronics Austria GmbH 2002. All Rights Reserved.

All technical data listed is for description purposes only and does not guarantee characteristics. All drawings, photos and descriptions are subject to change without prior notice.

We are not able to guarantee that the specified circuits, descriptions and tables are not covered by rights of third parties.

Terms of delivery and rights to change design reserved.

X-ON Electronics

Largest Supplier of Electrical and Electronic Components

Click to view similar products for [General Purpose Relays](#) category:

Click to view products by [TE Connectivity](#) manufacturer:

Other Similar products are found below :

[PCN-105D3MH,000](#) [59641F200](#) [5JO-1000CD-SIL](#) [LY1SAC110120](#) [5X827E](#) [5X837F](#) [5X840F](#) [5X842F](#) [5X848E](#) [LY2N-AC120](#) [LY2S-AC220/240](#) [LY2-US-AC120](#) [LY3-US-AC120](#) [LY4F-UA-DC12](#) [LY4F-UA-DC24](#) [LY4F-US-AC120](#) [LY4F-US-AC240](#) [LY4F-US-DC24](#) [LY4F-VD-AC110](#) [LYQ20DC12](#) [M115C60](#) [M115N010](#) [M115N0150](#) [6031007G](#) [603-12D](#) [61211T0B4](#) [61212T400](#) [61222Q400](#) [61243B600](#) [61243C500](#) [61243Q400](#) [61311BOA2](#) [61311BOA6](#) [61311BOA8](#) [61311C0A2](#) [61311COA1](#) [61311COA6](#) [61311F0A2](#) [61311QOA1](#) [61311QOA4](#) [61311T0D6](#) [61311TOA6](#) [61311TOA7](#) [61311TOB3](#) [61311TOB4](#) [61311U0A6](#) [61312Q600](#) [61312T400](#) [61312T600](#) [61313U200](#)