

LOC		DIST		REVISIONS			
				REV	PER	DATE	BY
-	-	F	REV PER ECO	14-003443		3-21-14	CT

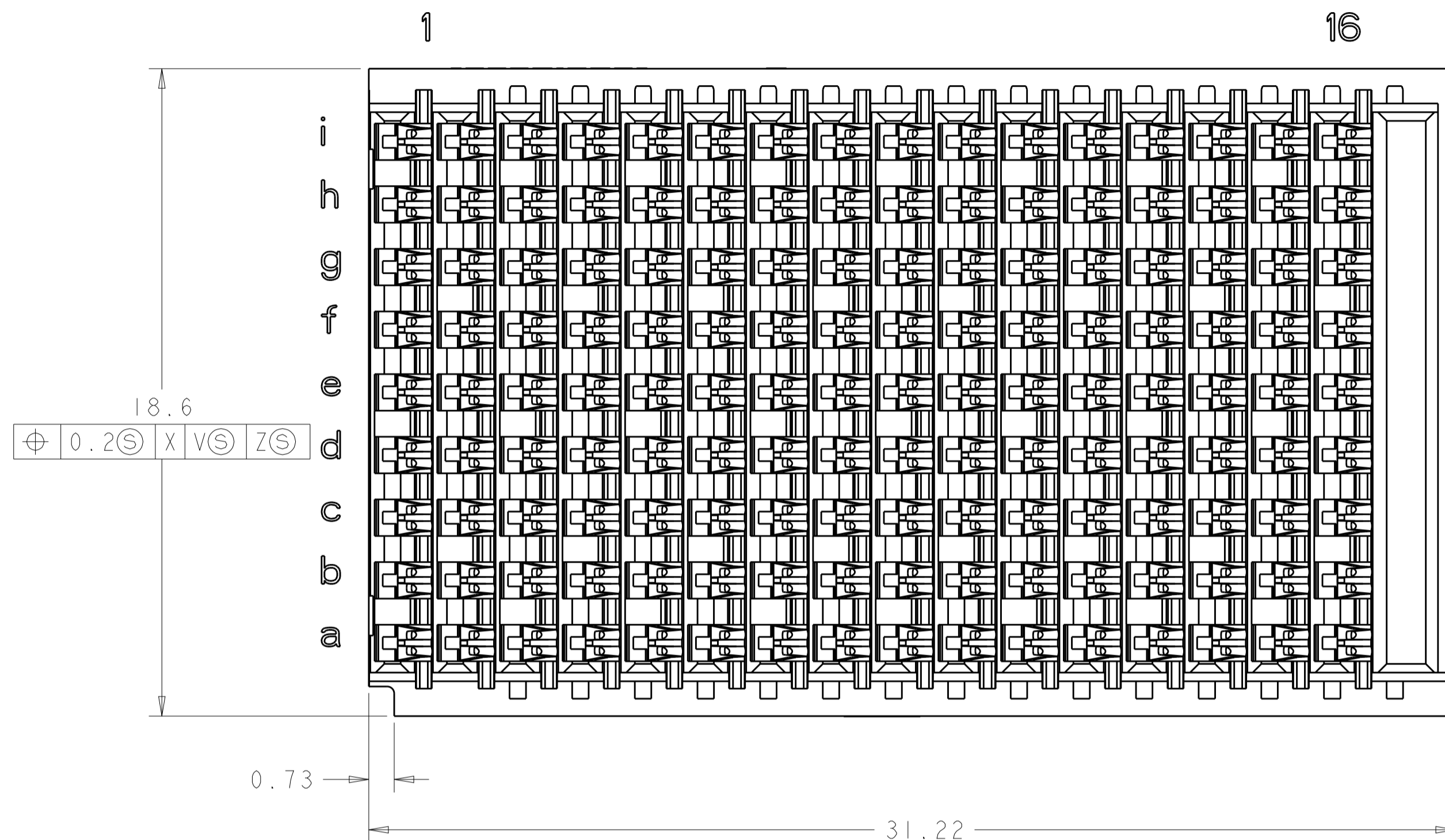

- △ HOUSING: LCP, UL94V0, COLOR: BLACK. CONTACT: PHOSPHOR BRONZE.
- △ FINISH: 1.27µm GOLD IN CONTACT AREA 1.27µm MIN. TIN-LEAD ON PCB TAIL OVER 3.81µm MIN. NICKEL OVER ALL.
- △ FINISH: 1.27µm GOLD IN CONTACT AREA 1.27µm MIN. TIN ON PCB TAIL OVER 3.81µm MIN. NICKEL OVER ALL.
- △ PLATE THROUGH HOLE PER TE SPEC. 114-13056 FIGURE 4.
- △ ADDITIONAL CONNECTOR-SIDE KEEPOUT AREA REQUIRED IF CONNECTOR-SIDE EXTRACTION TOOL IS TO BE USED.
- △ PLASTIC ALIGNMENT PIN MUST BE REMOVED FLUSH TO HOUSING BODY PRIOR TO INSERTION INTO RTM LAYOUT

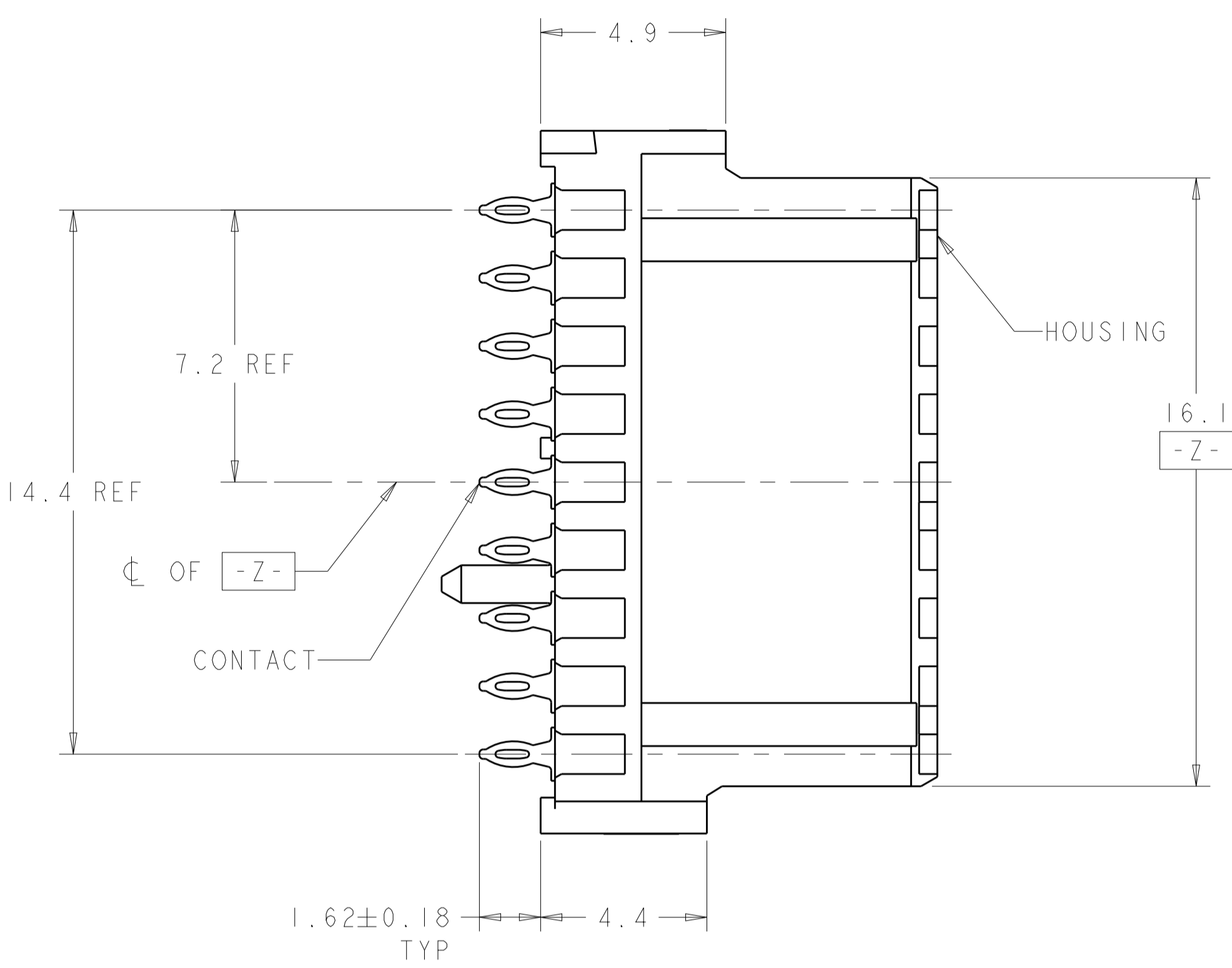
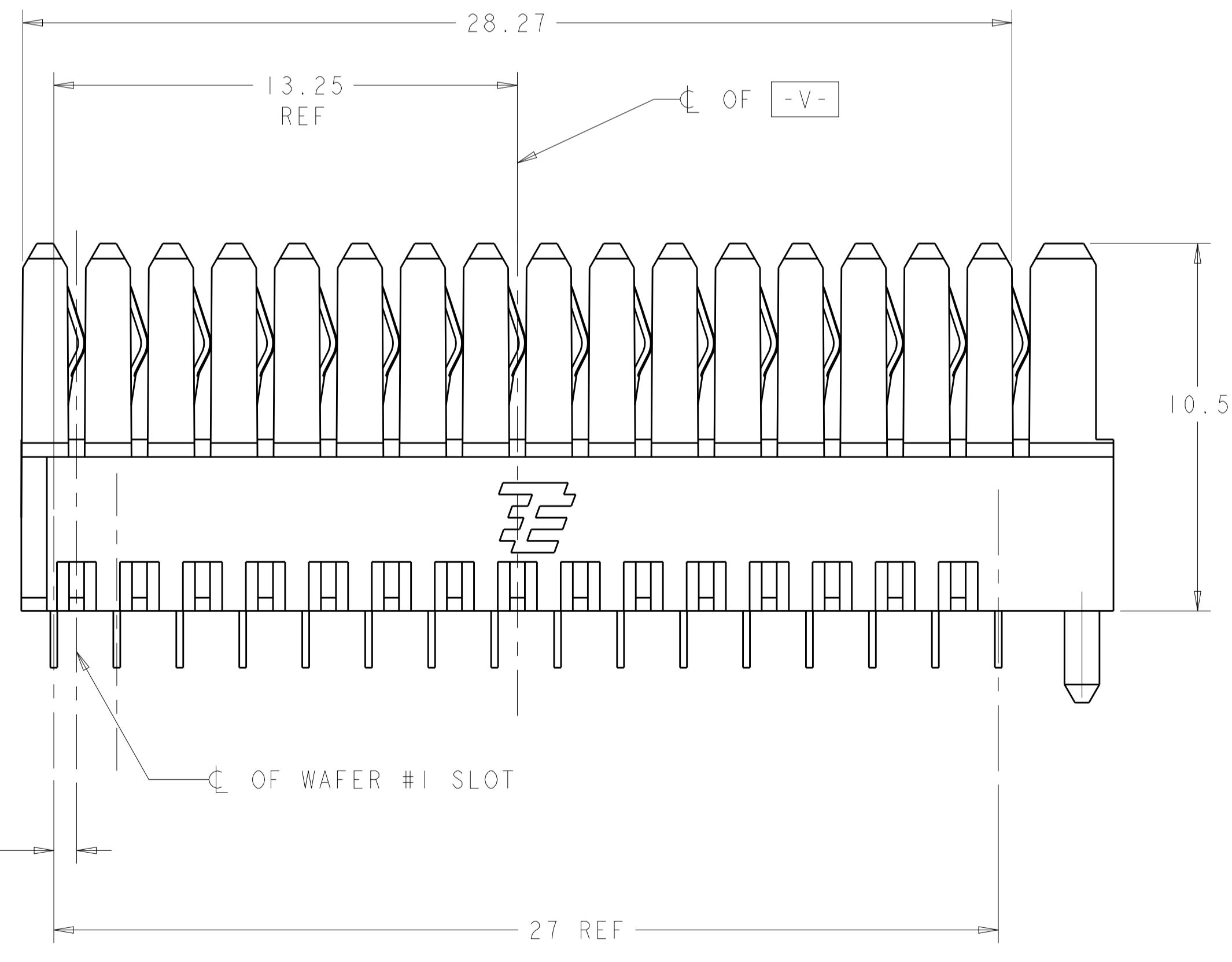
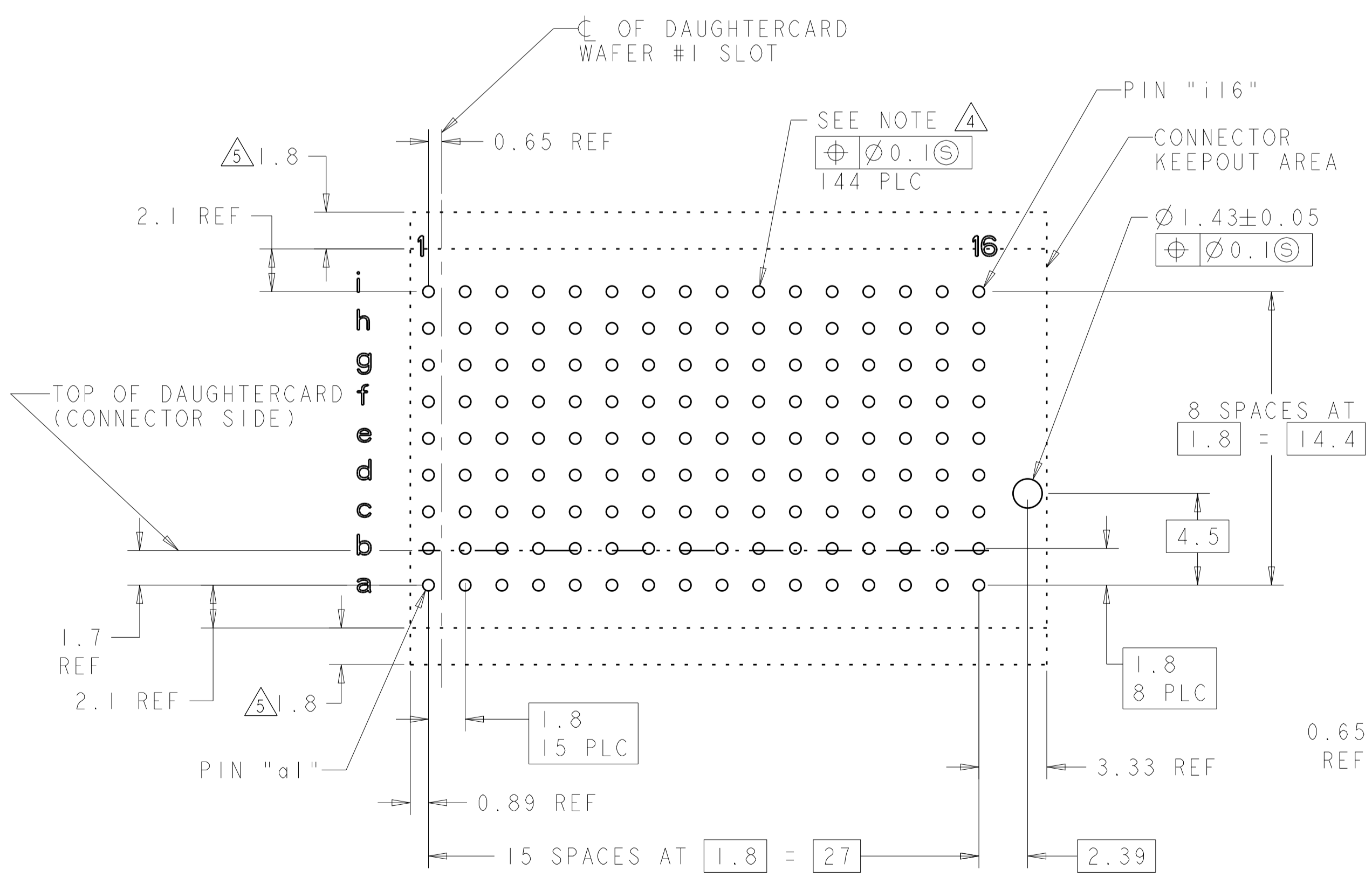

PC BOARD LAYOUT
(CONNECTOR SIDE)
(SEE SHEET 2 FOR RTM)
SCALE 5:1

△ 3	1410142-2
△ 2	1410142-1
PLATING	PART NO

THIS DRAWING IS A CONTROLLED DOCUMENT.

DIMENSIONS:	TOLERANCES UNLESS OTHERWISE SPECIFIED:	OWN: R. TREA 13NOV2002	CHK: J. CONSOLI 18NOV2002	APVD: 18NOV2002
mm	0 PLC ±0.5 1 PLC ±0.5 2 PLC ±0.13 3 PLC ±0.13 4 PLC ±0.13 ANGLES ±1°	PRODUCT SPEC: 108-2072	APPLICATION SPEC: 114-13056	WEIGHT: -
MATERIAL: △	SEE TABLE	SIZE: A1	CAGE CODE: 00779	DRAWING NO: 1410142
		CUSTOMER DRAWING		SCALE: 8:1

TE Connectivity
CONNECTOR ASSEMBLY, BACKPLANE VERTICAL RECEPTACLE, RIGHT END, 20.3mm, MultiGig RT 2

RESTRICTED TO SHEET 1 OF 2 REV F

LOC		DIST		REVISIONS			
P	LTN	DESCRIPTION	DATE	DMN	APVD		
-	-	SEE SHEET 1	-	-	-		

REAR TRANSITION MODULE APPLICATION

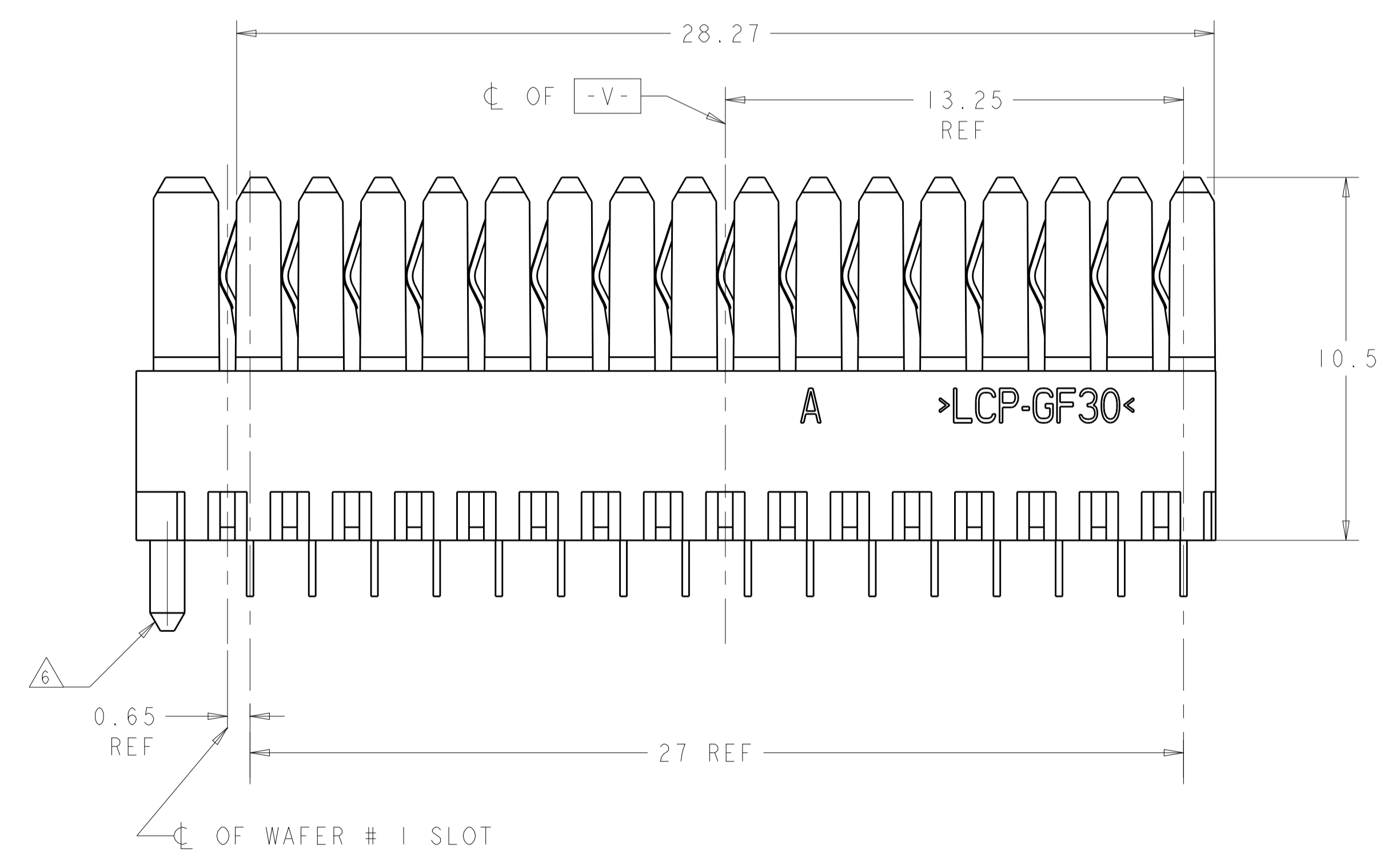
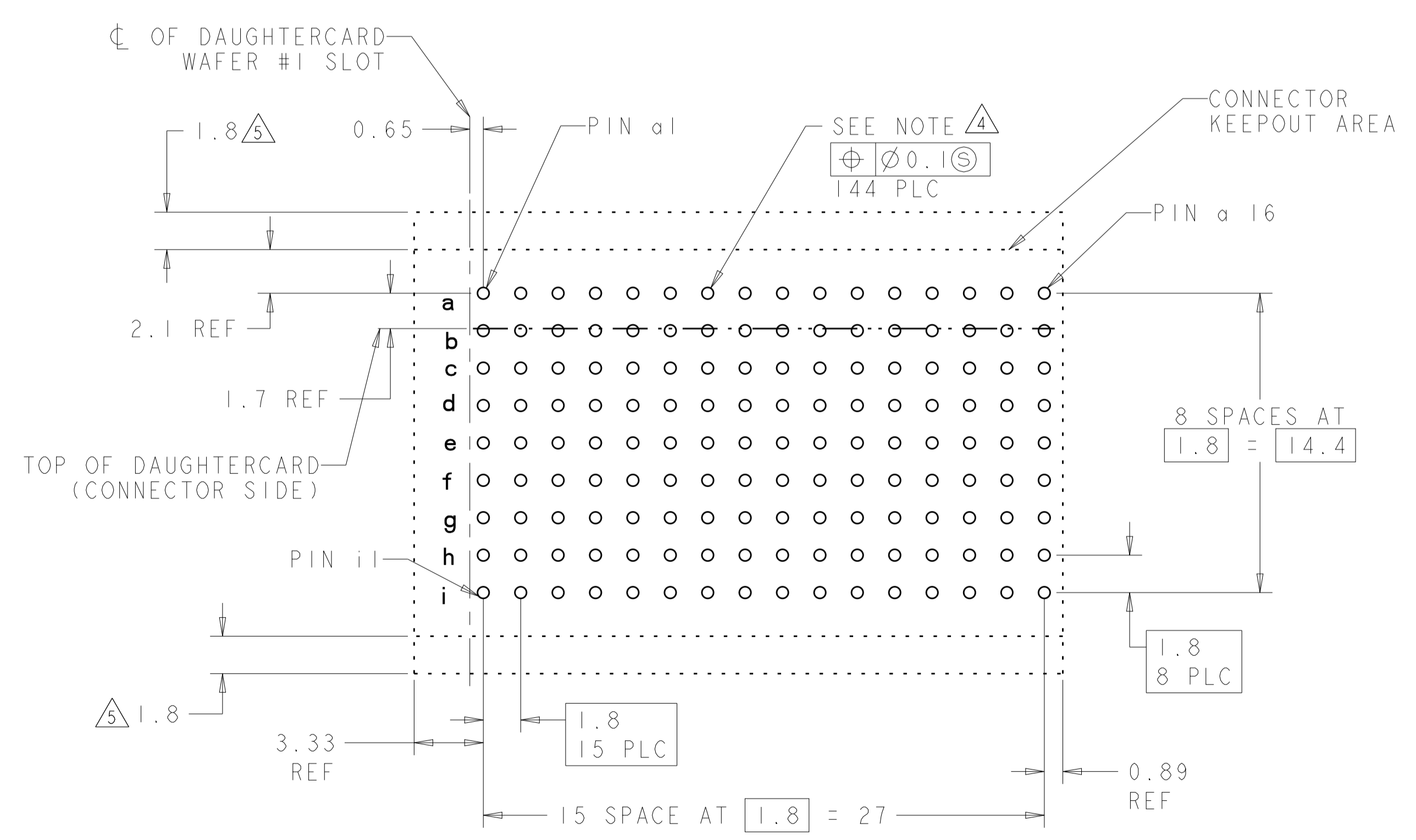
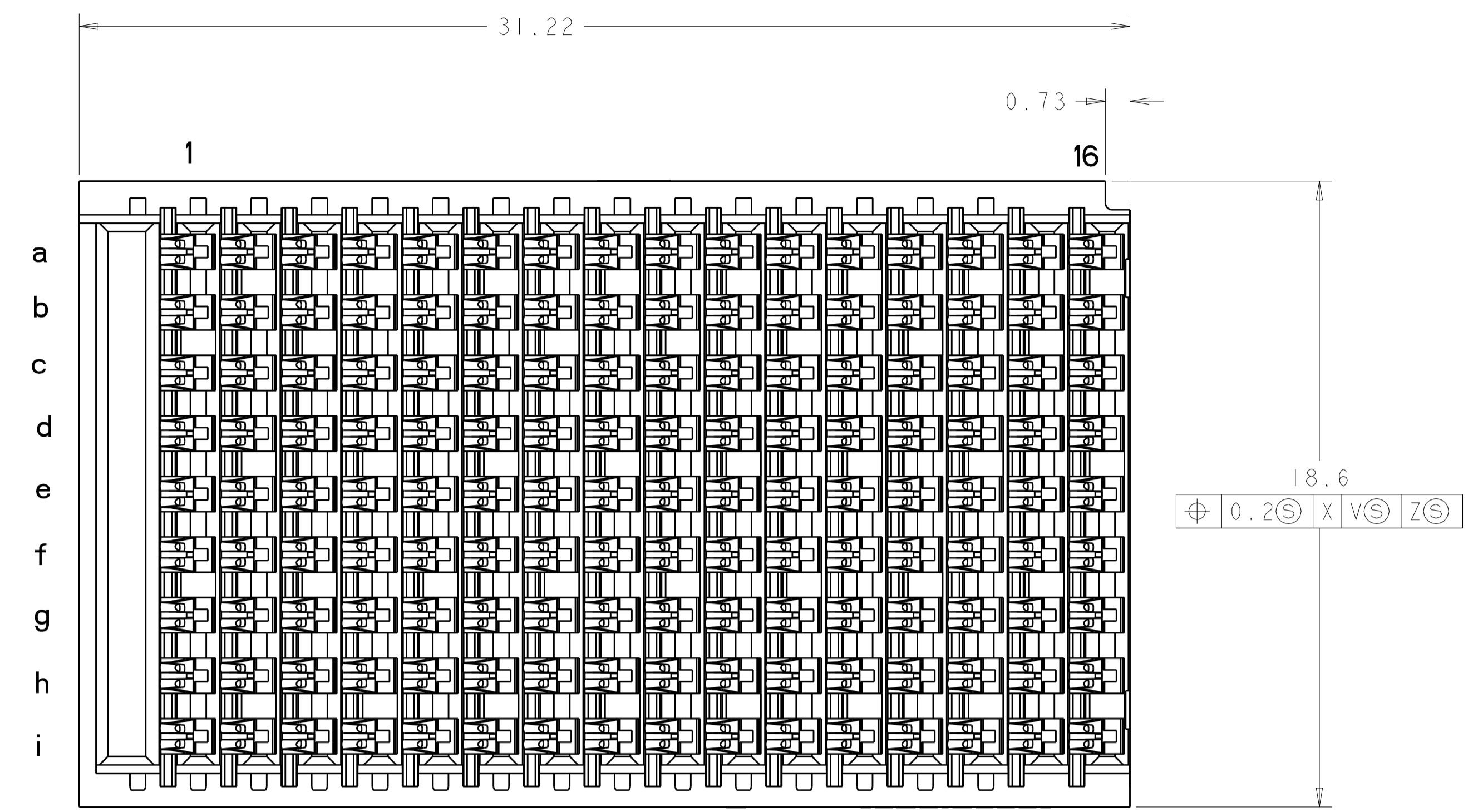
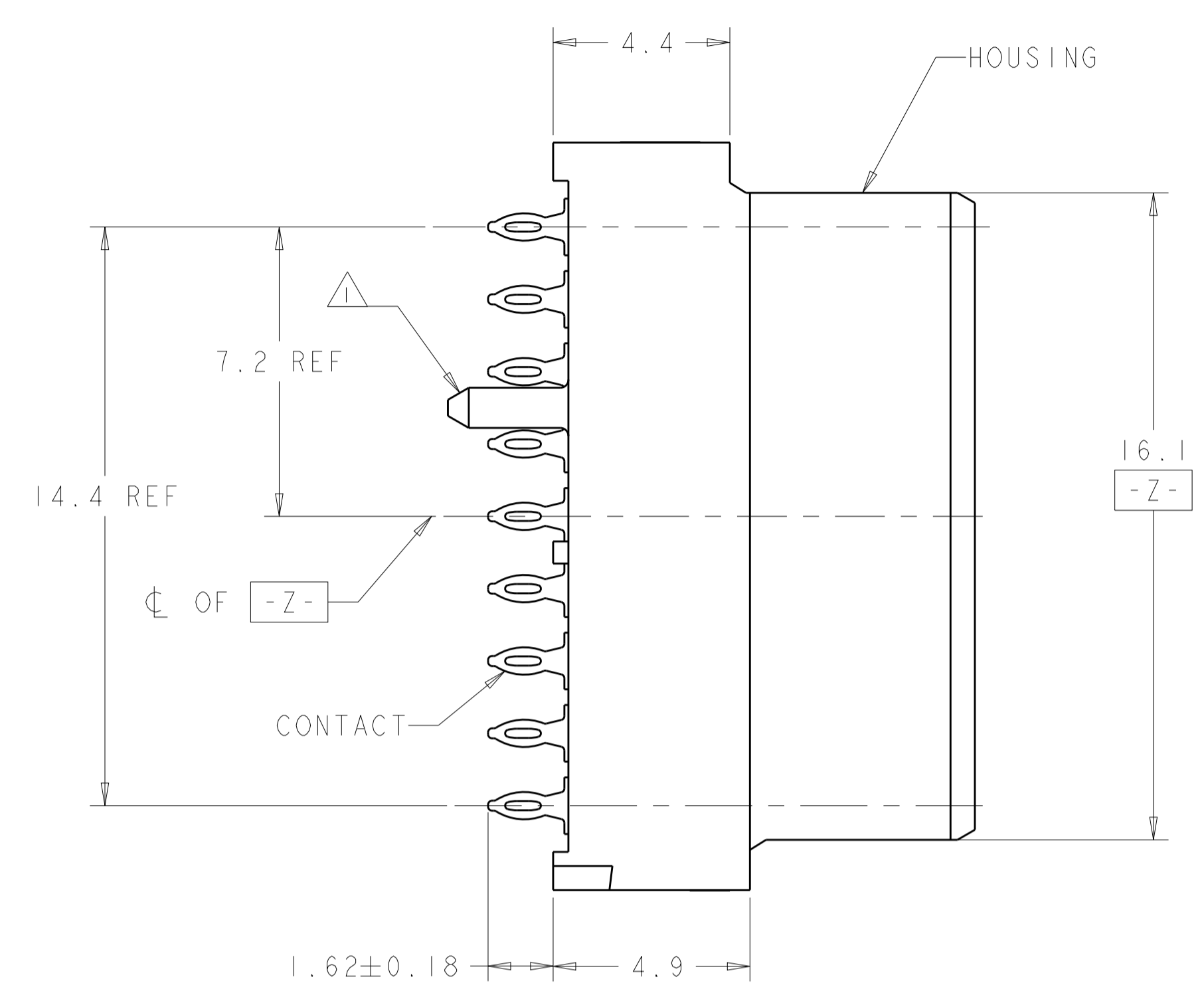

PC BOARD REAR TRANSITION MODULE (CONNECTOR SIDE) SCALE 5:1

THIS DRAWING IS A CONTROLLED DOCUMENT.		DMN: R. TREA 13NOV2002		TE Connectivity
DIMENSIONS: mm		CHK: J. CONSOLI 18NOV2002		NAME: CONNECTOR ASSEMBLY, BACKPLANE VERTICAL RECEPTACLE, RIGHT END, 20.3mm, MultiGig RT 2
TOLERANCES UNLESS OTHERWISE SPECIFIED:		APVD: J. CONSOLI 18NOV2002	PRODUCT SPEC: 108-2072	SIZE: A100779
0 PLC ±0.5		APPLICATION SPEC: 114-13056	RESTRICTED TO:	
1 PLC ±0.13		WEIGHT:	SCALE: 8:1	SHEET 2 OF 2
2 PLC ±0.13		FINISH: SEE TABLE	CUSTOMER DRAWING	REV F
3 PLC ±0.13				
4 PLC ±0.13				
5 PLC ±0.13				
6 ANGLE ±1°				

X-ON Electronics

Largest Supplier of Electrical and Electronic Components

Click to view similar products for [High Speed/Modular Connectors](#) category:

Click to view products by [TE Connectivity](#) manufacturer:

Other Similar products are found below :

[650827-1](#) [74040-1346](#) [1410191-1](#) [1410368-3](#) [1410964-2](#) [1410326-3](#) [1410367-3](#) [1410971-4](#) [1467833-1](#) [2000877-1](#) [2000878-1](#) [2041314-1](#)
[2065387-1](#) [2187307-1](#) [163P](#) [1934290-1](#) [2000875-1](#) [2065917-1](#) [2102736-2](#) [FSR-40](#) [2169868-2](#) [22354-8](#) [437-5040-000](#) [5-1393565-0](#) [039-](#)
[0246-000](#) [0740618502](#) [0761601016](#) [0784461022](#) [10123159-12ELF](#) [030-2415-003/100 PK](#) [030-7380-004](#) [030-2494-001](#) [532939-1](#) [5532901-](#)
[3](#) [3-1469268-7](#) [74748-102LF](#) [10041743-101LF](#) [10066670-100002LF](#) [1-533915-1](#) [249-4515-000](#) [7-1469373-3](#) [DL2-2J/S](#) [2000713-8](#)
[2000713-7](#) [10124313-101LF](#) [3011-21](#) [757105208](#) [EBTF-4-10-2.0-S-RA-1](#) [430305-001](#) [4395800100](#)