



TE Connectivity

CUSTOMER DATA

PART NO.

1432793-1

SHT. 1
OF 2

DRAWN E.SIMPSON	APPROVAL B. TOEPFER	DATE FIRST_DRAWN 05-26-05	SCALE 1:1
--------------------	------------------------	------------------------------	--------------

CUSTOMER TYCO_ELECTRONICS_STANDARD

TOLERANCE	0.X	=	+/-
UNLESS	0.XX	=	+/-
SPECIFIED	0.XXX	=	+/-
OTHERWISE	ANGLES	=	+/-

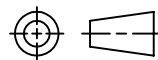

DO NOT SCALE THIS DRAWING

CHANGES

REV.	DATE	CO	APP.
	04OCT2016	ECR-16-014229	B.T.
	06NOV2017	ECO-17-003787	B.T.

NOT TO BE USED IN AUTOMOTIVE APPLICATIONS OR APPLICATIONS REQUIRING PPAP AND/OR IMDS DOCUMENTATION
ELECTRICAL CHARACTERISTICS: (ALL DATA APPLIES @ 23°C UNLESS OTHERWISE SPECIFIED)

COIL DATA:

NOMINAL VOLTAGE:	12 VDC
OPERATE VOLTAGE:	7.8 VDC MAXIMUM
RELEASE VOLTAGE:	1.2 VDC MINIMUM
COIL RESISTANCE:	90 OHMS +/- 10%
OPERATE TIME:	10 mSEC. MAXIMUM EXCLUDING BOUNCE
RELEASE TIME:	13 mSEC. MAXIMUM EXCLUDING BOUNCE
TEMPERATURE RANGE:	OPERATING -40°C TO +85°C

CONTACT DATA: (CONTACT DATA IS FORMATTED N.O./N.C.)

CONTACT ARRANGEMENT:	1 FORM C (SPDT)
CONTACT MATERIAL:	AgSnO (SILVER TIN-OXIDE)
CONTACT MILLIVOLT DROP:	200mv @ 35A ON N.O. CONTACTS (AFTER SWITCHING) 250mv @ 20A ON N.C. CONTACTS (AFTER SWITCHING)
MAXIMUM MAKE CURRENT:	90A/30A (LAMP) @ 16 VDC
MAXIMUM BREAK CURRENT:	40A/30A @ 16 VDC RESISTIVE
MAXIMUM CONTINUOUS CURRENT:	40A/30A @ 23°C , 35A/20A @ 85°C
INITIAL BREAKDOWN CURRENT	500V RMS CONTACTS TO COIL

EXPECTED LIFE:	100,000 OPERATIONS, 40 A, 14 VDC RESISTIVE ON NORMALLY OPEN CONTACT
----------------	---

MECHANICAL CHARACTERISTICS:

EXPECTED LIFE:	10 MILLION OPERATIONS, NO CONTACT LOAD
TERMINALS	COPPER, UNPLATED



TE Connectivity

CUSTOMER DATA

PART NO.

1432793-1

SHT. 2
OF 2

DRAWN E. SIMPSON	APPROVAL B. TOEPFER	DATE FIRST_DRAWN 05-26-05	SCALE 1:1
---------------------	------------------------	------------------------------	--------------

CUSTOMER
TYCO_ELECTRONICS_STANDARD

TOLERANCE 0.X = +/-
 UNLESS 0.XX = +/-
 SPECIFIED 0.XXX = +/-
 OTHERWISE ANGLES = +/-

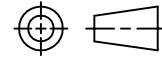

DO NOT SCALE THIS DRAWING

REV D

MILLIMETERS

MARKING TO INCLUDE:

TYCO ELECTRONICS NAME, TYCO ELECTRONICS PART NUMBER, SCHEMATIC, COIL VOLTAGE, COUNTRY OF ORIGIN, AND DATE CODE

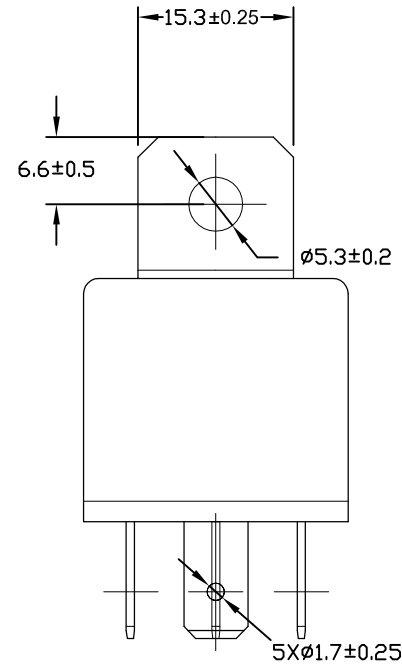
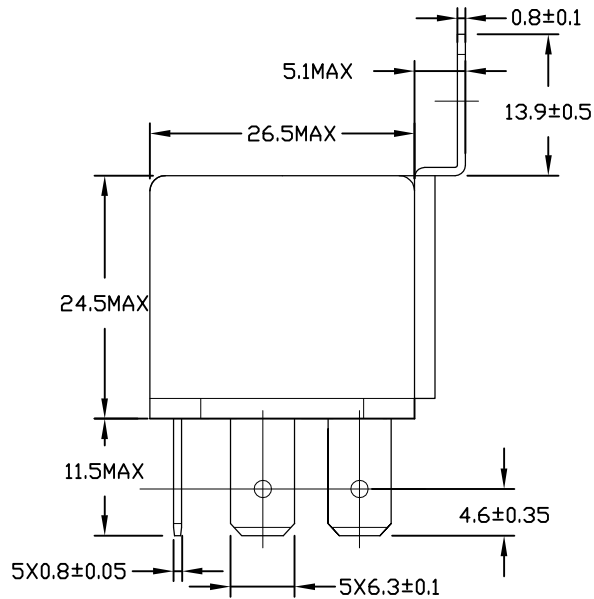

* TERMINAL LOCATIONS APPLY AT THE BASE OF THE TERMINALS

K Aspect

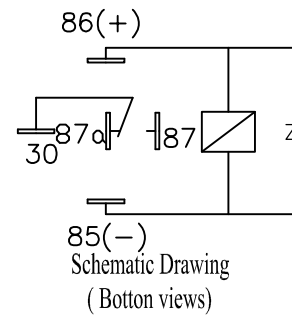
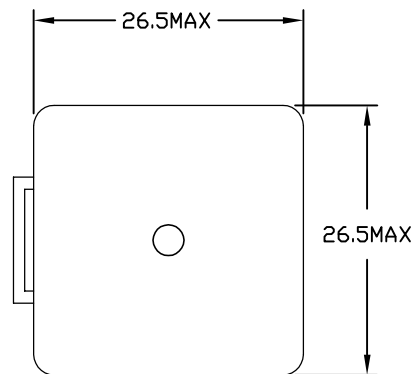
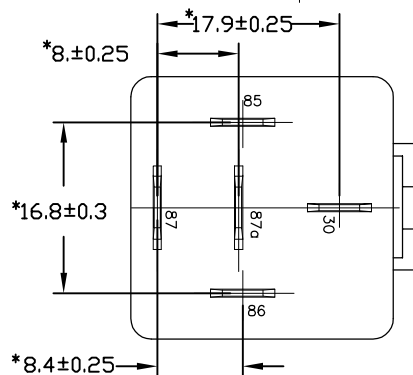

NOT TO BE USED IN AUTOMOTIVE APPLICATIONS OR APPLICATIONS REQUIRING PPAP AND/OR IMDS DOCUMENTATION

X-ON Electronics

Largest Supplier of Electrical and Electronic Components

Click to view similar products for [Automotive Relays](#) category:

Click to view products by [TE Connectivity](#) manufacturer:

Other Similar products are found below :

[7-1414968-8](#) [7-1617345-6](#) [9-1617516-5](#) [G5CE1ASIDC12](#) [1393204-2](#) [1393302-3](#) [13Z99A115-0074](#) [1432872-1](#) [AR4-15F11-S01](#) [AR4-15H11](#)
[1617057-2](#) [1617058-6](#) [1617518-5](#) [2-1617057-2](#) [2-1617057-6](#) [2-1617058-3](#) [CB1F-M-12V-H15](#) [898H-1AH-D-001-12VDC](#) [AR4-11F11](#)
[AR4-15F11](#) [AR4-41F11](#) [24198-1](#) [4-1617057-0](#) [41FZ-200ACG-BSL](#) [5-1616920-2](#) [5-1617052-9](#) [5407-0011-HS](#) [CB1AF-M-12V-H59](#) [5-](#)
[1617346-8](#) [103-1AH-C-12VDC](#) [V23134A1052X299](#) [6-1393302-1](#) [897H-1AH-D-R1-U01-12VDC](#) [FTR-P3CP024W1-06](#) [1-1617057-8](#) [3-](#)
[1393305-1](#) [5436-0001-HS](#) [V23086-R1851-A502](#) [V23136-A0004-X075](#) [898H-1AH-D1SW-R1-12VDC](#) [RH4C1P2607](#) [RE031005](#)
[V23134M0052G242](#) [1393204-1](#) [23234B0001X001-EV-144](#) [AZ979-1A-24D](#) [2-1904020-1](#) [V23134B0052C642](#) [V23134B0053C642](#) [V23234-](#)
[A1001-X036](#)