

THIS DRAWING IS UNPUBLISHED. RELEASED FOR PUBLICATION  
 © COPYRIGHT - By - ALL RIGHTS RESERVED.

REVISIONS					
変更					
P	LTR	DESCRIPTION	DATE	DWN	APVD
	P2	RELEASED(ECR-18-019397)	22MAR2019	J.J	W.H

注記  
NOTE

1. 一般公差: ±0.3  
1. GENERAL TOLERANCE: ±0.3
2. 梱包数量: 10,000ケ/リール  
2. PACKING STYLE: 10,000pcs/reel
3. 材質:  
3. MATERIAL:  
シールドフィンガー: 銅合金(ニッケル下地金めっき 0.05μmMIN.)  
SHIELD FINGER: COPPER ALLOY (GOLD-PLATING 0.05μm MIN.)  
(SOLDER-PLATING ON THE BOTTOM PLANE ONLY)

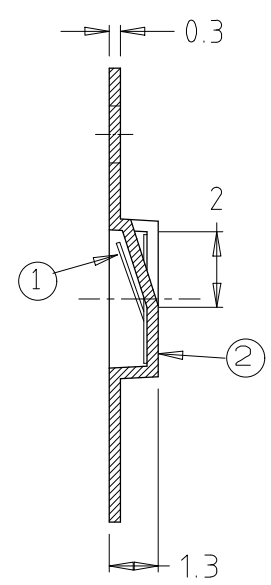

SECT. A-A

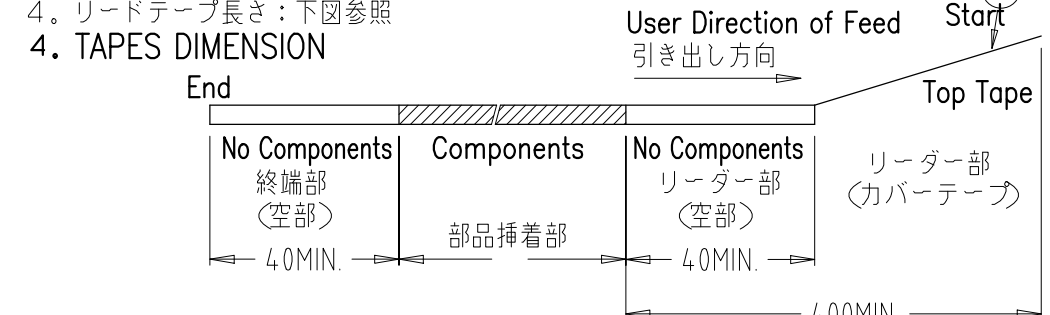
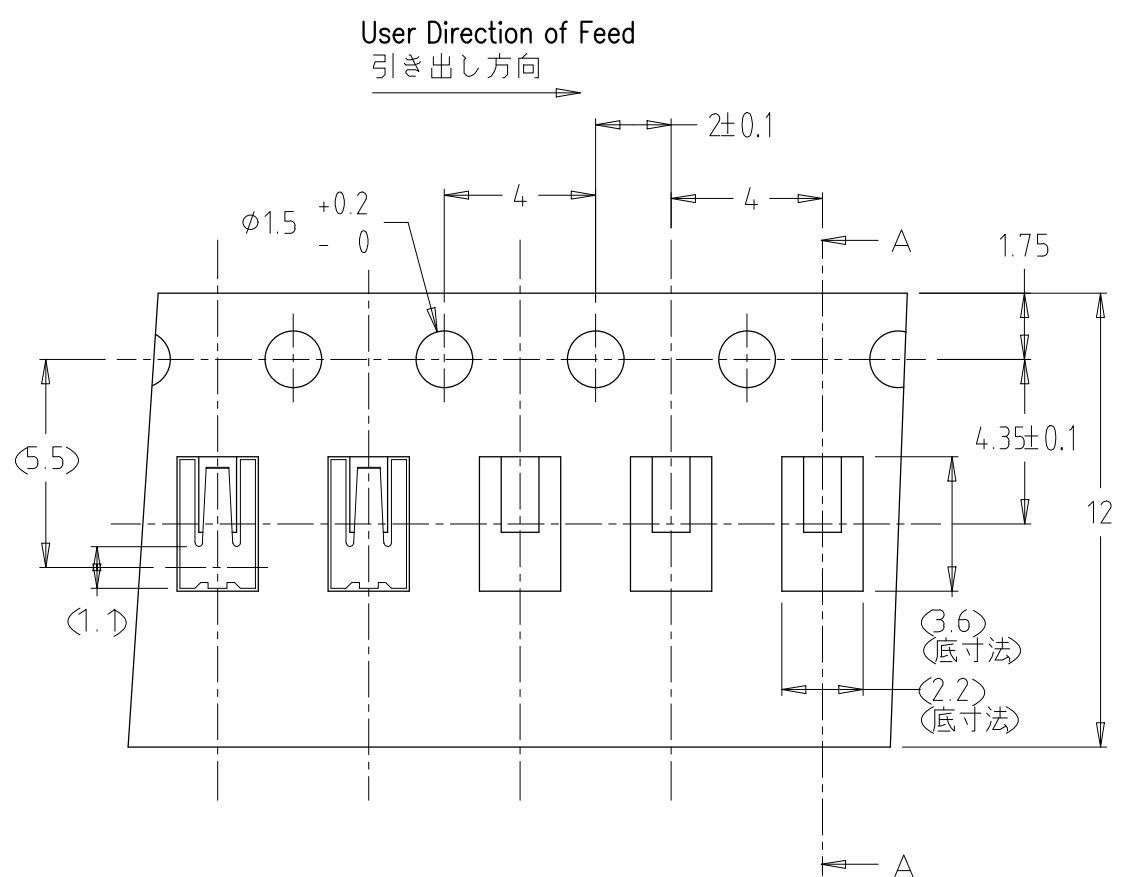

4. リードテープ長さ: 下図参照  
4. TAPES DIMENSION
5. リール参考寸法: 下図参照  
5. REEL DIMENSION: REFERENCE ONLY

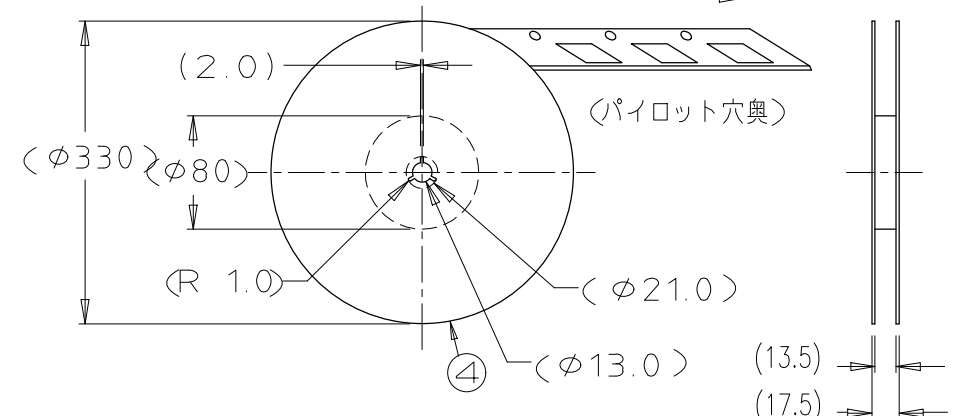

シールドフィンガー0820  
SHIELD FINGER 0820

旧型番: 3400089 S=10/1  
OLD CAT.NO.340009

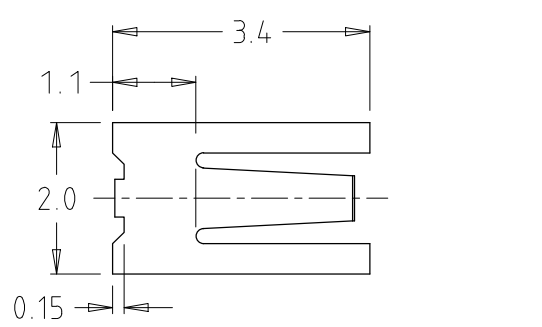

参考パッド寸法 (公差±0.1)  
RECOMMENDED FOOT PRINT  
REFERENCE ONLY  
(GENERAL TOLERANCE: ±0.1)

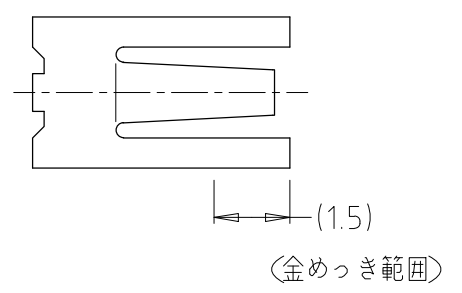
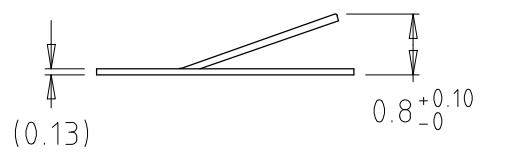
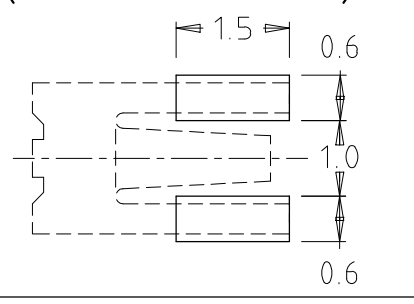

テピング梱包型番 PACKAGING Cat.No.	旧テピング梱包型番 PACKAGING Cat.No.	№.	名称 DESIGNATION	型番 Cat. No.	数量 QUANTITY
1447009-5	3100029	④	リール REEL	(旧型番: 3150008)	1
		③	カバーテープ	(旧型番: 3150027)	1
		②	エンボスキャリアテープ CARRIER TAPE	(旧型番: 3150026)	10000ポケット (部品装着部)
		①	シールドフィンガー0820 SHIELD FINGER 0820	(旧型番: 3400089)	10000ケ

THIS DRAWING IS A CONTROLLED DOCUMENT.

DWN (K.TAMURA) 19SEP00  
CHK T.KUBO 16OCT00  
APVD

PRODUCT SPEC  
APPLICATION SPEC

STE TE Connectivity

PACKAGING OF SHIELD FINGER 0820 ON CONTINUOUS TAPES

SIZE A3 CAGE CODE 00779 DRAWING NO. C-1447009-5 RESTRICTED TO

WEIGHT 0.000000

CUSTOMER DRAWING SCALE 5:1 SHEET 1 OF 1 REV P2

## X-ON Electronics

Largest Supplier of Electrical and Electronic Components

*Click to view similar products for [EMI Gaskets, Sheets, Absorbers & Shielding](#) category:*

*Click to view products by [TE Connectivity](#) manufacturer:*

Other Similar products are found below :

[8101010140](#) [8563-0090-89](#) [1194-7.7X10](#) [1245-34"X18YD](#) [1267](#) [1345-3/8x18yrd](#) [1554907-1](#) [2320002000](#) [2320014700](#) [SG293037DS](#)  
[ST005PCN50](#) [55005107](#) [38M4040AA0606](#) [46J5N02020.NN00](#) [1125-8X10](#) [1126X1"](#) [1170-3/4X18YDS](#) [1170-7.7x10](#) [1183-12"X18YD](#) [6-](#)  
[34T-BD-0.315](#) [SG125187D-24](#) [SG125250R-24](#) [SG187375R-24](#) [SG284050DS](#) [8402010540](#) [KIT TECH CLIP](#) [1194](#) [10-40450-28S](#) [1245](#)  
[1267-1/2"x18yd](#) [46J8501020.NN00](#) [1170-1/4"x18yd](#) [AL-36FR-1x54.5](#) [3013310A](#) [1194X1"](#) [3020604](#) [3021302](#) [3031313](#) [260709](#) [3021310](#) [6-](#)  
[34UT-070-BD-16](#) [303076048](#) [46J5N03020.NN00](#) [30206025](#) [30395641](#) [3030403](#) [3690103020](#) [HNY-LT15CU4241](#) [46X7503020.NN00](#)  
[46W5E02520.NN00](#)