

REVISIONS				
P	LTR	DESCRIPTION	DATE	APPV
L		REVISED PER ECO-20-001912	03JUN2020	SB JO

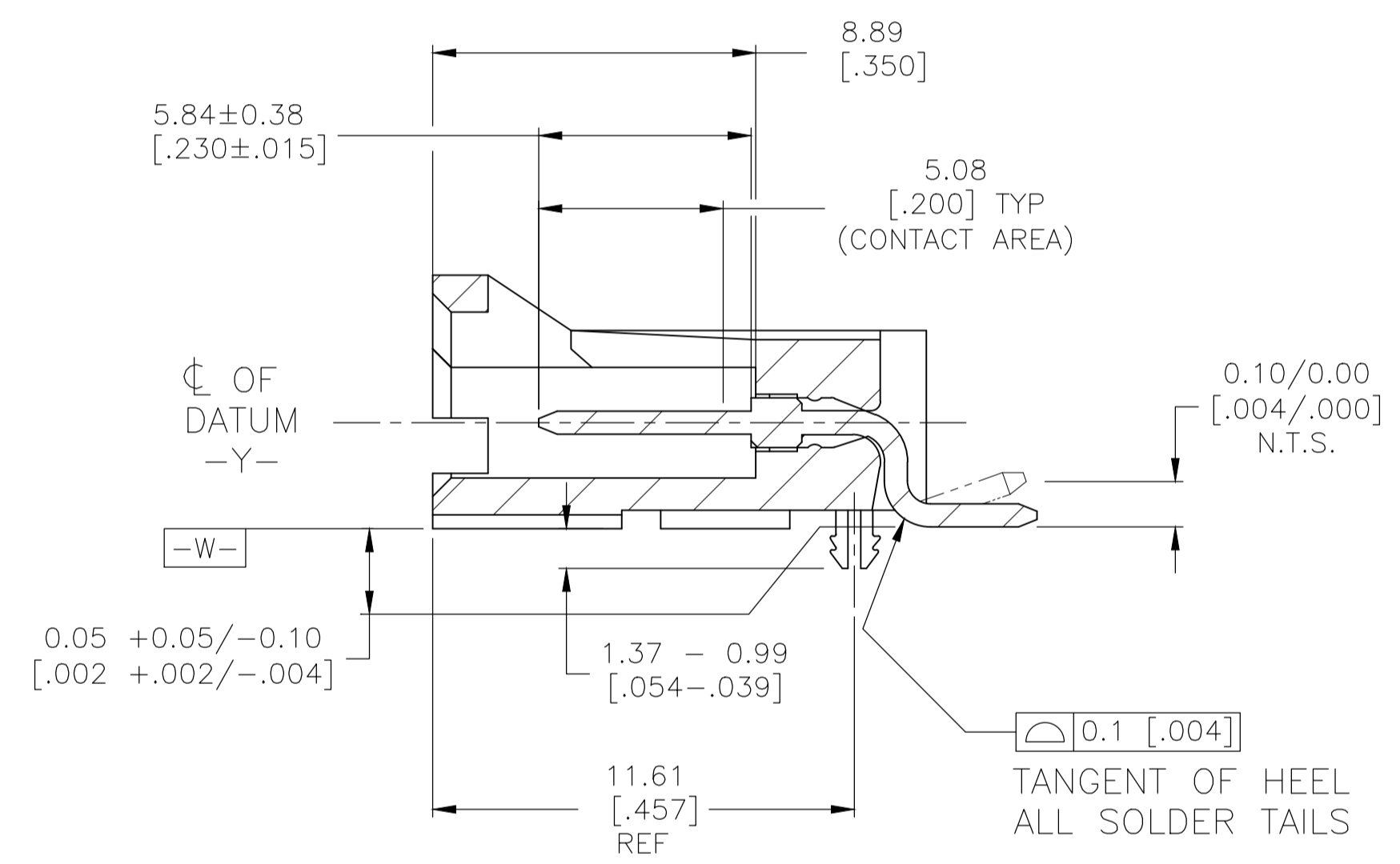

- 1 HOUSING: LCP, COLOR-BLACK.  
POST: BRASS.
- 2 POST: 0.00254-0.00508 [.000100-.00200] BRIGHT TIN-LEAD OVER  
0.00127-0.00254 [.000050-.000100] NICKEL.
- 3 DATUMS AND BASIC DIMENSIONS ESTABLISHED BY THE CUSTOMER.
- 4 TWO POLARIZATION SLOTS ON ASSEMBLIES WITH FOUR OR MORE  
POSITIONS.
- 5 0.00254-0.00508 [.000100-.000200] BRIGHT TIN OVER  
0.00127-0.00254 [.000050-.000100] NICKEL.
- 6 PRELIMINARY PART - NOT RELEASED FOR PRODUCTION.
- 7 0.00254-0.00508 [.000100-.000200] MATTE TIN OVER  
0.00127-0.00254 [.000050-.000100] NICKEL.
- 8 0.25 [.010] RECESS PERMISSIBLE IN THIS AREA FOR MOLD SHUT OFF

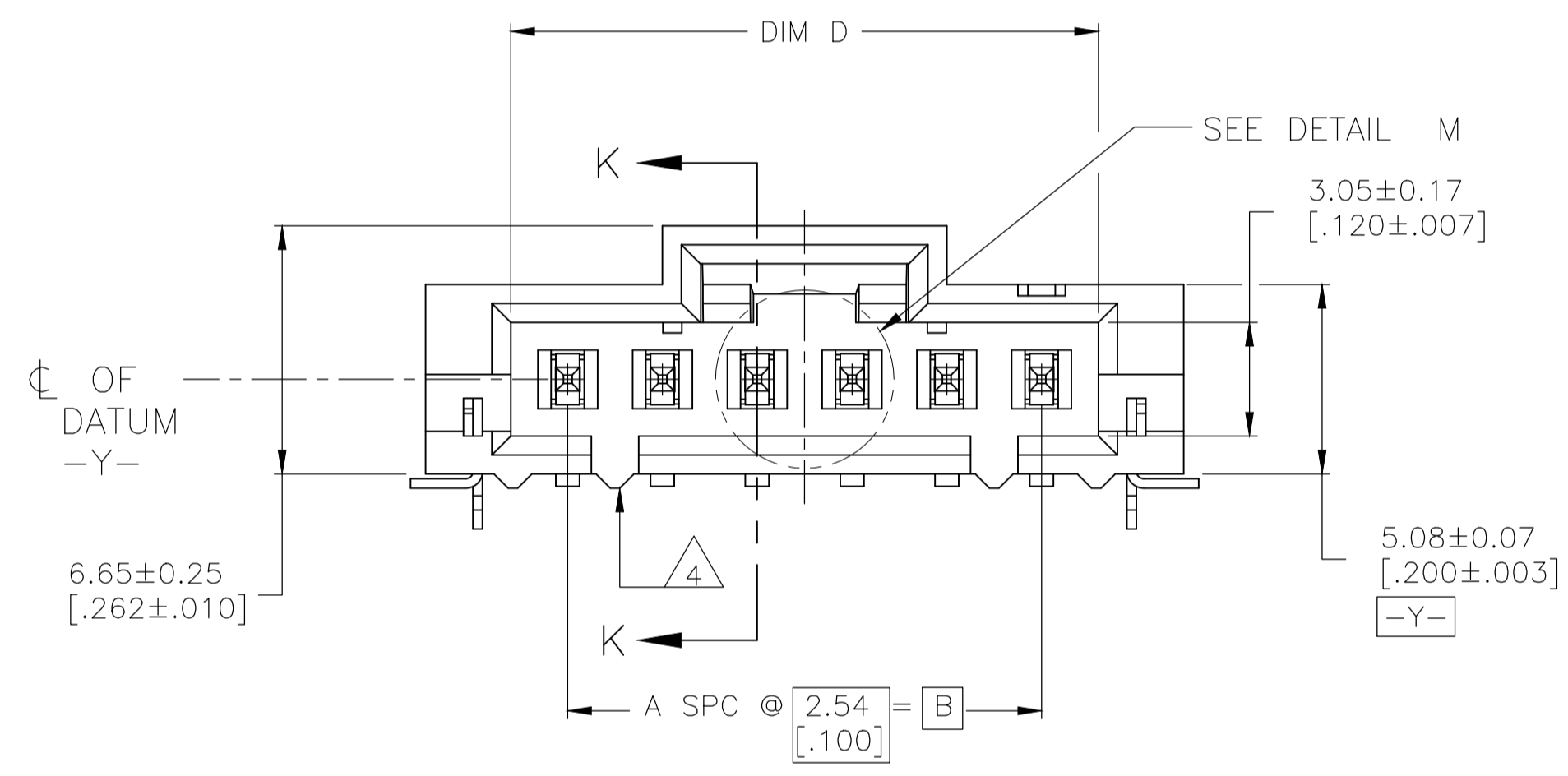
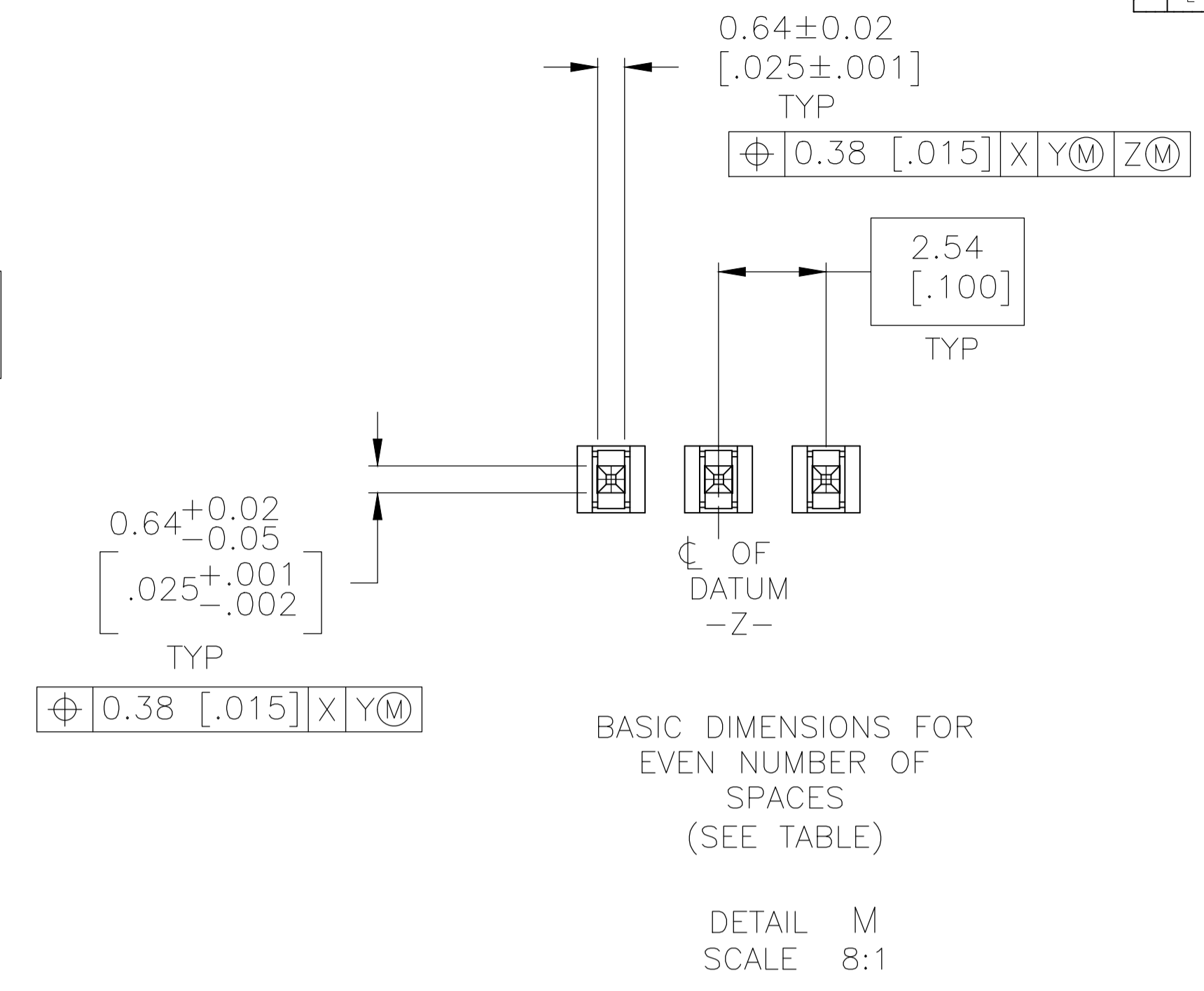
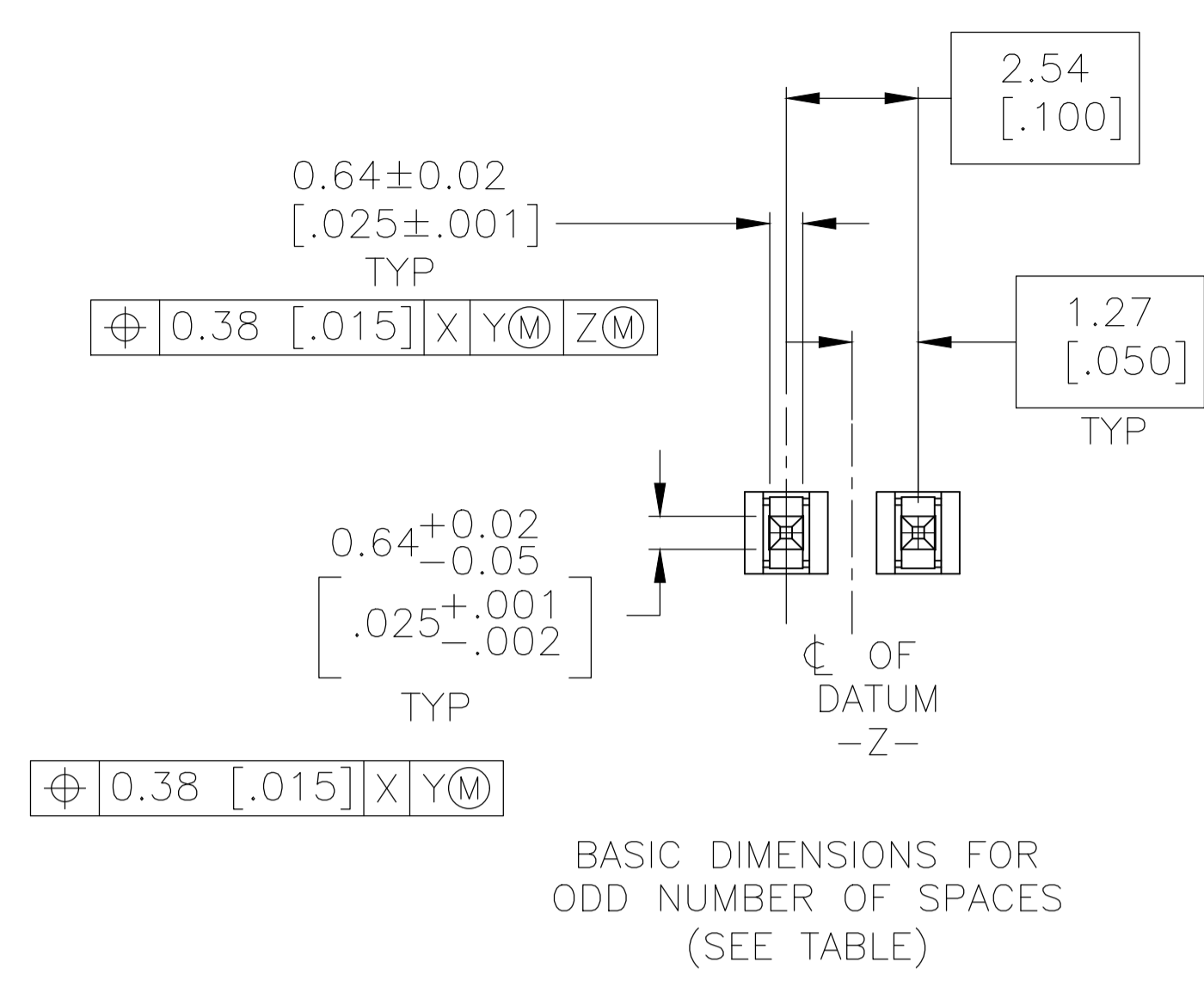
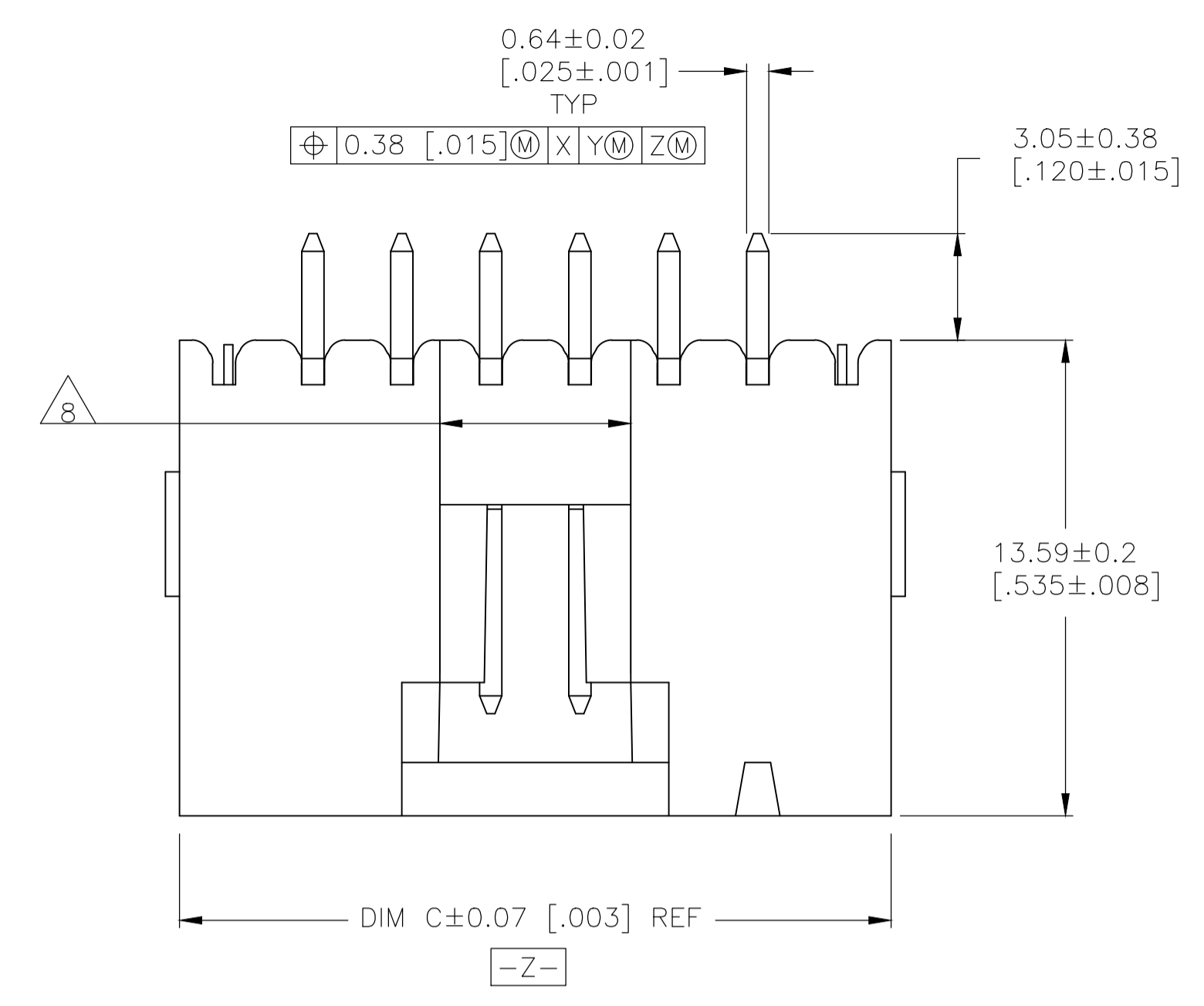
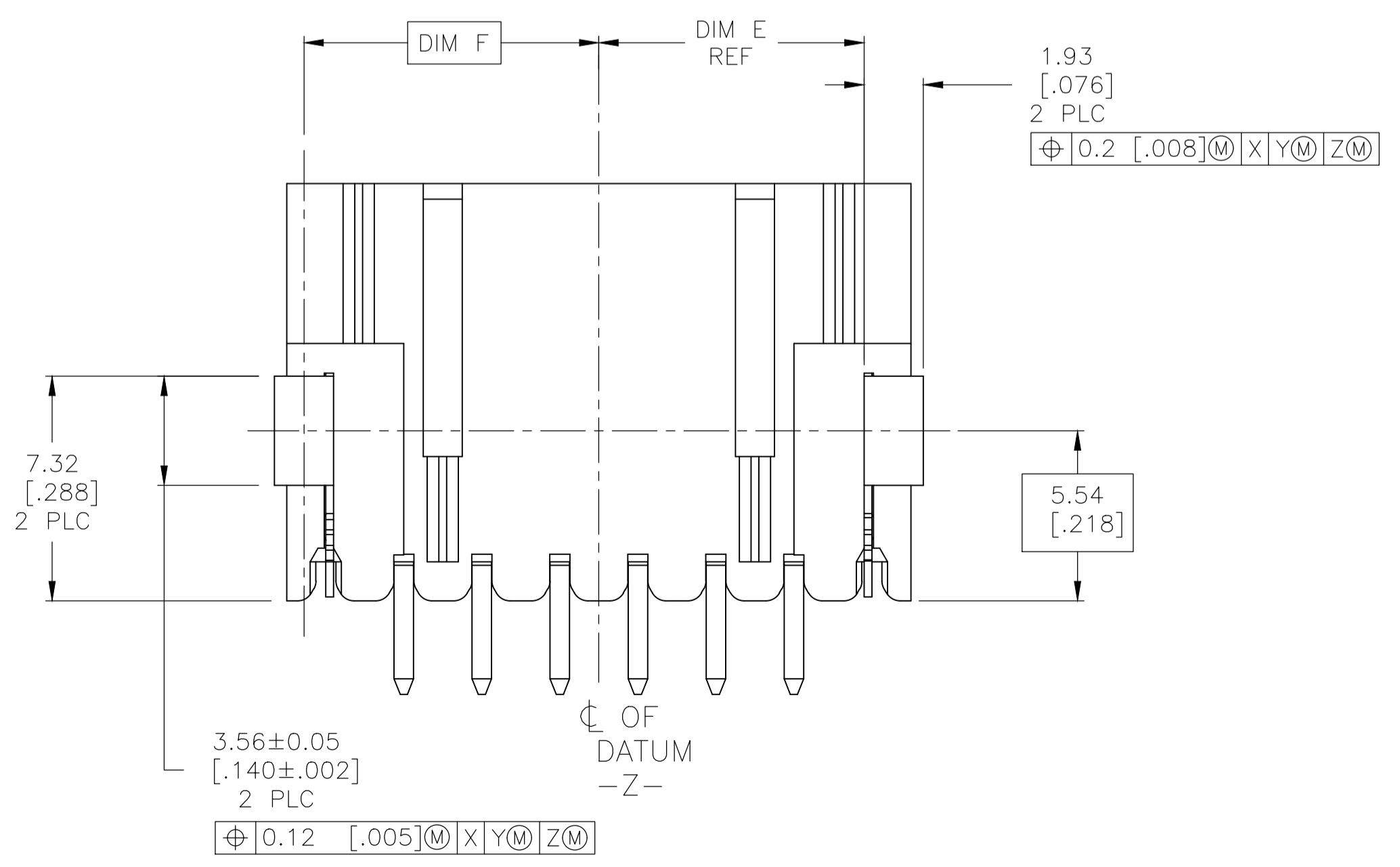

SEE TABLE ON  
SHEET #3

THIS DRAWING IS A CONTROLLED DOCUMENT.		DIN B. HAYMAKER 02DEC99	 TE Connectivity Ltd.
DIMENSIONS: mm [INCHES]		CHK J. MOSIER 02DEC99	
TOLERANCES UNLESS OTHERWISE SPECIFIED:		APPV J. MOSIER 02DEC99	NAME
0 PLC ± -		PRODUCT SPEC	HEADER ASSEMBLY, LATCHING, RIGHT ANGLE SURFACE MOUNT, MTE, AMPMODU
1 PLC ± -		APPLICATION SPEC	108-25034
2 PLC ± -		SIZE	A1
3 PLC ± 0.13 [.005]		WEIGHT	147324
4 PLC ± -		CUSTOMER DRAWING	SCALE 6:1 SHEET 1 OF 4 REV L
ANGLES ± -			
MATERIAL	FINISH	SEE TABLE	

REVISIONS				
P	LTR	DESCRIPTION	DATE	APPV
-	-	SEE SHEET 1	-	-

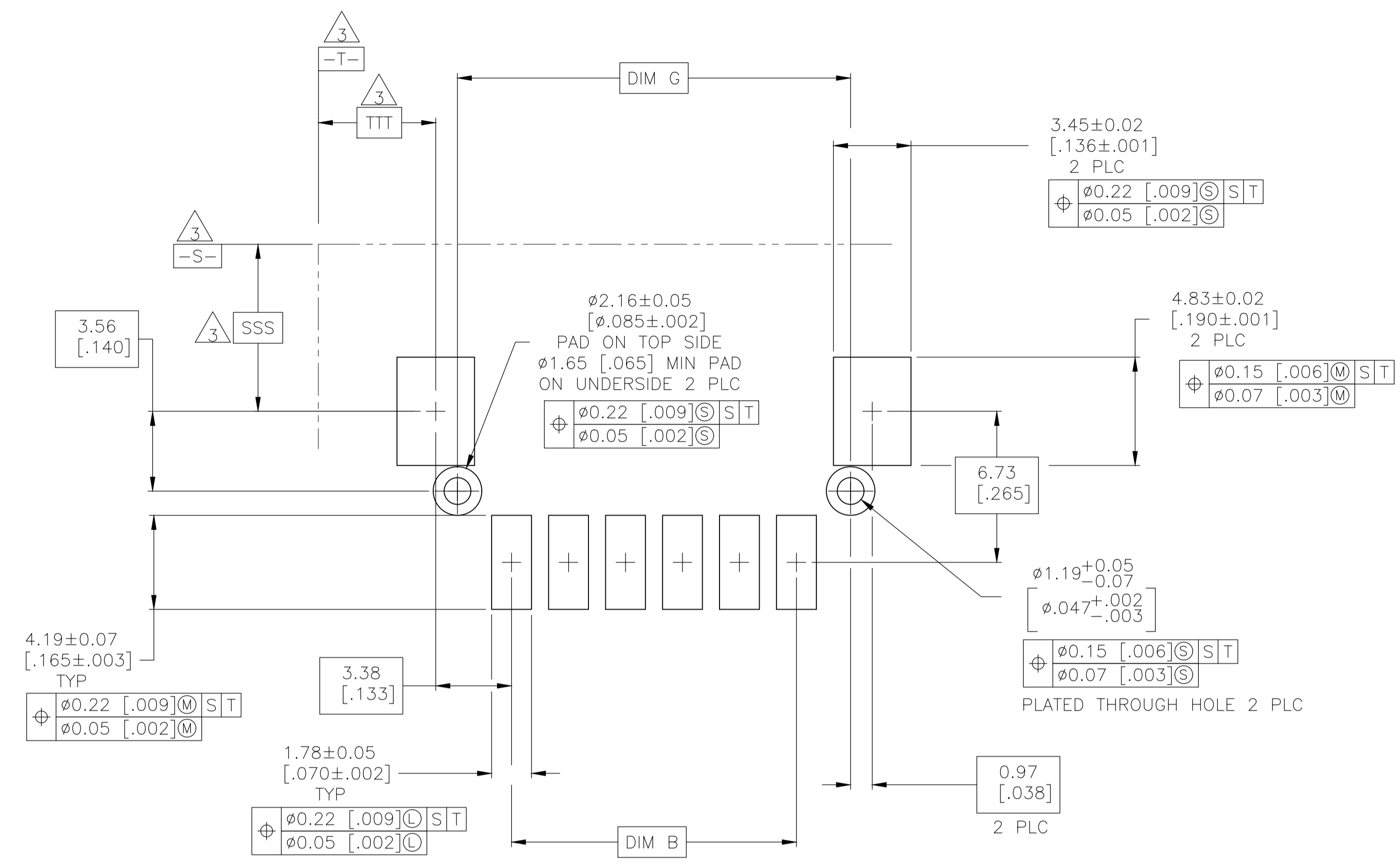

RECOMMENDED PC BOARD LAYOUT

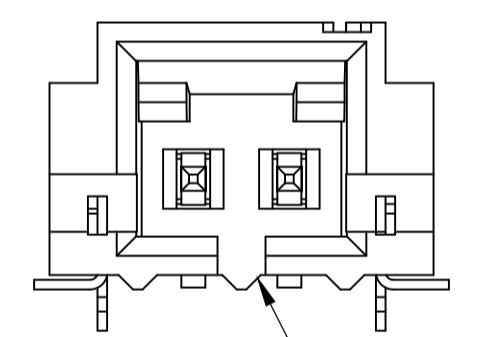

POLARIZATION SLOT FOR TWO POSITION

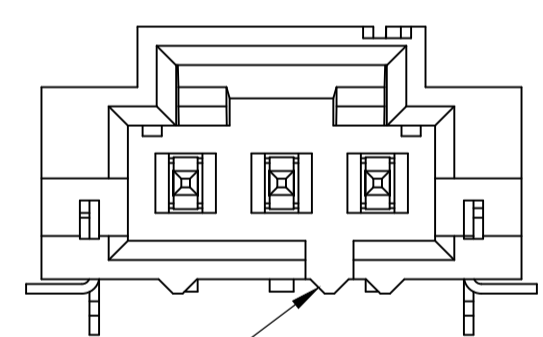

POLARIZING SLOT FOR THREE POSITION

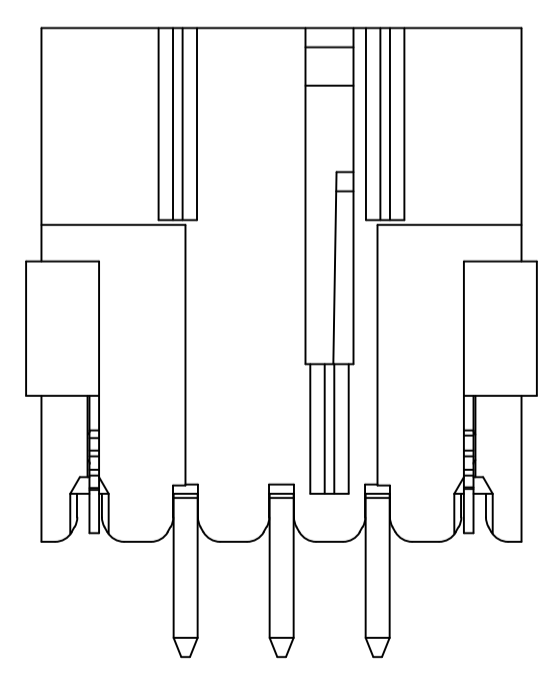
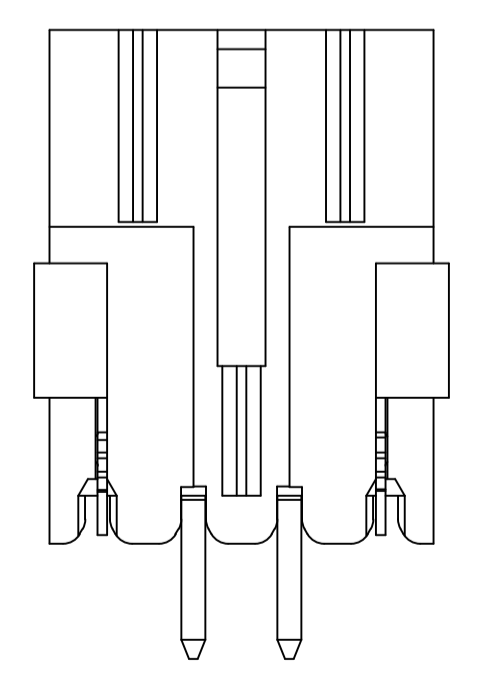

THIS DRAWING IS A CONTROLLED DOCUMENT.		DIN EJ HAYMAKER 02DEC99	TE Connectivity Ltd.
DIMENSIONS: mm [INCHES]		CHK J. MOSIER 02DEC99	
TOLERANCES UNLESS OTHERWISE SPECIFIED:		APPV J. MOSIER 02DEC99	NAME HEADER ASSEMBLY, LATCHING, RIGHT ANGLE SURFACE MOUNT, MTE, AMPMODU
0 PLC ± - 1 PLC ± - 2 PLC ± - 3 PLC ± 0.13 [.005] 4 PLC ± - ANGLES ± ± -		PRODUCT SPEC 108-25034	RESTRICTED TO
MATERIAL 1		FINISH SEE TABLE	SIZE A1
WEIGHT -		DRAWING NO 147324	SCALE 6:1
CUSTOMER DRAWING		SHEET 2 OF 4	REV L

REVISIONS				
P	LTR	DESCRIPTION	DATE	APVD
-		SEE SHEET 1	-	-

△5	44	17.53 [.690]	9.60 [.378]	8.64 [.340]	15.75 [.620]	20.19 [.795]	12.70 [.500]	5	6	2-147324-7
△5	44	27.69 [1.090]	14.68 [.578]	13.72 [.540]	25.91 [1.020]	30.35 [1.195]	22.86 [.900]	9	10	2-147324-6
△5	24	7.37 [.290]	4.52 [.178]	3.56 [.140]	5.59 [.220]	10.03 [.395]	2.54 [.100]	1	2	2-147324-5
△2	88	65.79 [2.590]	33.73 [1.328]	32.77 [1.290]	64.01 [2.520]	68.45 [2.695]	60.96 [2.400]	24	25	2-147324-4
△2	88	63.25 [2.490]	32.46 [1.278]	31.50 [1.240]	61.47 [2.420]	65.91 [2.595]	58.42 [2.300]	23	24	2-147324-3
△2	88	60.71 [2.390]	31.19 [1.228]	30.23 [1.190]	58.93 [2.320]	63.37 [2.495]	55.88 [2.200]	22	23	2-147324-2
△2	88	58.17 [2.290]	29.92 [1.178]	28.96 [1.140]	56.39 [2.220]	60.83 [2.395]	53.34 [2.100]	21	22	2-147324-1
△2	88	55.63 [2.190]	28.65 [1.128]	27.69 [1.090]	53.85 [2.120]	58.29 [2.295]	50.80 [2.000]	20	21	2-147324-0
△2	72	53.09 [2.090]	27.38 [1.078]	26.42 [1.040]	51.31 [2.020]	55.75 [2.195]	48.26 [1.900]	19	20	1-147324-9
△2	72	50.55 [1.990]	26.11 [1.028]	25.15 [.990]	48.77 [1.920]	53.21 [2.095]	45.72 [1.800]	18	19	1-147324-8
△2	72	48.01 [1.890]	24.84 [.978]	23.88 [.940]	46.23 [1.820]	50.67 [1.995]	43.18 [1.700]	17	18	1-147324-7
△2	72	45.47 [1.790]	23.57 [.928]	22.61 [.890]	43.69 [1.720]	48.13 [1.895]	40.64 [1.600]	16	17	1-147324-6
△2	72	42.93 [1.690]	22.30 [.878]	21.34 [.840]	41.15 [1.620]	45.59 [1.795]	38.10 [1.500]	15	16	1-147324-5
△2	72	40.39 [1.590]	21.03 [.828]	20.07 [.790]	38.61 [1.520]	43.05 [1.695]	35.56 [1.400]	14	15	1-147324-4
△2	56	37.85 [1.490]	19.76 [.778]	18.80 [.740]	36.07 [1.420]	40.51 [1.595]	33.02 [1.300]	13	14	1-147324-3
△2	56	35.31 [1.390]	18.49 [.728]	17.53 [.690]	33.53 [1.320]	37.97 [1.495]	30.48 [1.200]	12	13	1-147324-2
△2	56	32.77 [1.290]	17.22 [.678]	16.26 [.640]	30.99 [1.220]	35.43 [1.395]	27.94 [1.100]	11	12	1-147324-1
△2	56	30.23 [1.190]	15.95 [.628]	14.99 [.590]	28.45 [1.120]	32.89 [1.295]	25.40 [1.000]	10	11	1-147324-0
△2	44	27.69 [1.090]	14.68 [.578]	13.72 [.540]	25.91 [1.020]	30.35 [1.195]	22.86 [.900]	9	10	147324-9
△2	44	25.15 [.990]	13.41 [.528]	12.45 [.490]	23.37 [.920]	27.81 [1.095]	20.32 [.800]	8	9	147324-8
△2	44	22.61 [.890]	12.14 [.478]	11.18 [.440]	20.83 [.820]	25.27 [.995]	17.78 [.700]	7	8	147324-7
△2	44	20.07 [.790]	10.87 [.428]	9.91 [.390]	18.29 [.720]	22.73 [.895]	15.24 [.600]	6	7	147324-6
△2	44	17.53 [.690]	9.60 [.378]	8.64 [.340]	15.75 [.620]	20.19 [.795]	12.70 [.500]	5	6	147324-5
△2	32	14.99 [.590]	8.33 [.328]	7.37 [.290]	13.21 [.520]	17.65 [.695]	10.16 [.400]	4	5	147324-4
△2	24	12.45 [.490]	7.06 [.278]	6.10 [.240]	10.67 [.420]	15.11 [.595]	7.62 [.300]	3	4	147324-3
△2	24	9.91 [.390]	5.79 [.228]	4.83 [.190]	8.13 [.320]	12.57 [.495]	5.08 [.200]	2	3	147324-2
△2	24	7.37 [.290]	4.52 [.178]	3.56 [.140]	5.59 [.220]	10.03 [.395]	2.54 [.100]	1	2	147324-1
PLATING	EIA 481 TAPE WIDTH mm	G	F	E	D	C	B	A	NO OF POSN	PART NUMBER

THIS DRAWING IS A CONTROLLED DOCUMENT.

DIMENSIONS: mm [INCHES]	TOLERANCES UNLESS OTHERWISE SPECIFIED: 0. PLC ± - 1. PLC ± - 2. PLC ± - 3. PLC ± 0.13 [.005] 4. PLC ± - ANGLES ± -	DIN B HAYMAKER 02DEC99 CIK 02DEC99 APVD J. MOSIER 02DEC99	STE TE Connectivity Ltd.
	FINISH SEE TABLE	NAME HEADER ASSEMBLY, LATCHING, RIGHT ANGLE SURFACE MOUNT, MTE, AMPMODU	RESTRICTED TO
MATERIAL △1	WEIGHT -	SIZE A1 CASE CODE 00779 DRAWING NO 147324	CUSTOMER DRAWING
		SCALE 1:1	SHEET 3 OF 4

REVISIONS				
P	LTR	DESCRIPTION	DATE	APPD
-		SEE SHEET 1	-	-

	88	65.79 [2.590]	33.73 [1.328]	32.77 [1.290]	64.01 [2.520]	68.45 [2.695]	60.96 [2.400]	24	25	7-147324-4
	88	63.25 [2.490]	32.46 [1.278]	31.50 [1.240]	61.47 [2.420]	65.91 [2.595]	58.42 [2.300]	23	24	7-147324-3
	88	60.71 [2.390]	31.19 [1.228]	30.23 [1.190]	58.93 [2.320]	63.37 [2.495]	55.88 [2.200]	22	23	7-147324-2
	88	58.17 [2.290]	29.92 [1.178]	28.96 [1.140]	56.39 [2.220]	60.83 [2.395]	53.34 [2.100]	21	22	7-147324-1
	88	55.63 [2.190]	28.65 [1.128]	27.69 [1.090]	53.85 [2.120]	58.29 [2.295]	50.80 [2.000]	20	21	7-147324-0
	72	53.09 [2.090]	27.38 [1.078]	26.42 [1.040]	51.31 [2.020]	55.75 [2.195]	48.26 [1.900]	19	20	6-147324-9
	72	50.55 [1.990]	26.11 [1.028]	25.15 [.990]	48.77 [1.920]	53.21 [2.095]	45.72 [1.800]	18	19	6-147324-8
	72	48.01 [1.890]	24.84 [.978]	23.88 [.940]	46.23 [1.820]	50.67 [1.995]	43.18 [1.700]	17	18	6-147324-7
	72	45.47 [1.790]	23.57 [.928]	22.61 [.890]	43.69 [1.720]	48.13 [1.895]	40.64 [1.600]	16	17	6-147324-6
	72	42.93 [1.690]	22.30 [.878]	21.34 [.840]	41.15 [1.620]	45.59 [1.795]	38.10 [1.500]	15	16	6-147324-5
	72	40.39 [1.590]	21.03 [.828]	20.07 [.790]	38.61 [1.520]	43.05 [1.695]	35.56 [1.400]	14	15	6-147324-4
	56	37.85 [1.490]	19.76 [.778]	18.80 [.740]	36.07 [1.420]	40.51 [1.595]	33.02 [1.300]	13	14	6-147324-3
	56	35.31 [1.390]	18.49 [.728]	17.53 [.690]	33.53 [1.320]	37.97 [1.495]	30.48 [1.200]	12	13	6-147324-2
	56	32.77 [1.290]	17.22 [.678]	16.26 [.640]	30.99 [1.220]	35.43 [1.395]	27.94 [1.100]	11	12	6-147324-1
	56	30.23 [1.190]	15.95 [.628]	14.99 [.590]	28.45 [1.120]	32.89 [1.295]	25.40 [1.000]	10	11	6-147324-0
	44	27.69 [1.090]	14.68 [.578]	13.72 [.540]	25.91 [1.020]	30.35 [1.195]	22.86 [.900]	9	10	5-147324-9
	44	25.15 [.990]	13.41 [.528]	12.45 [.490]	23.37 [.920]	27.81 [1.095]	20.32 [.800]	8	9	5-147324-8
	44	22.61 [.890]	12.14 [.478]	11.18 [.440]	20.83 [.820]	25.27 [.995]	17.78 [.700]	7	8	5-147324-7
	44	20.07 [.790]	10.87 [.428]	9.91 [.390]	18.29 [.720]	22.73 [.895]	15.24 [.600]	6	7	5-147324-6
	44	17.53 [.690]	9.60 [.378]	8.64 [.340]	15.75 [.620]	20.19 [.795]	12.70 [.500]	5	6	5-147324-5
	32	14.99 [.590]	8.33 [.328]	7.37 [.290]	13.21 [.520]	17.65 [.695]	10.16 [.400]	4	5	5-147324-4
	24	12.45 [.490]	7.06 [.278]	6.10 [.240]	10.67 [.420]	15.11 [.595]	7.62 [.300]	3	4	5-147324-3
	24	9.91 [.390]	5.79 [.228]	4.83 [.190]	8.13 [.320]	12.57 [.495]	5.08 [.200]	2	3	5-147324-2
	24	7.37 [.290]	4.52 [.178]	3.56 [.140]	5.59 [.220]	10.03 [.395]	2.54 [.100]	1	2	5-147324-1
PLATING	EIA 481 TAPE WIDTH mm	G	F	E	D	C	B	A	NO OF POSN	PART NUMBER

THIS DRAWING IS A CONTROLLED DOCUMENT.

DIMENSIONS: mm [INCHES]	TOLERANCES UNLESS OTHERWISE SPECIFIED: 0. PLC ± - 1. PLC ± - 2. PLC ± - 3. PLC ± 0.13 [.005] 4. PLC ± - ANGLES ± -	DIN B HAYMAKER 02DEC99 CIK 02DEC99 J. MOSIER APVD J. MOSIER 02DEC99	NAME 108-25034 APPLICATION SPEC	SIZE A1	SCALE 1:1	DRAWING NO 147324	RESTRICTED TO
MATERIAL 	FINISH SEE TABLE	WEIGHT -	CUSTOMER DRAWING	SHEET 4 OF 4	REV L	TE Connectivity Ltd. HEADER ASSEMBLY, LATCHING, RIGHT ANGLE SURFACE MOUNT, MTE, AMPMODU	

## X-ON Electronics

Largest Supplier of Electrical and Electronic Components

*Click to view similar products for [Headers & Wire Housings](#) category:*

*Click to view products by [TE Connectivity](#) manufacturer:*

Other Similar products are found below :

[892-18-020-10-001101](#) [58102-G61-06LF](#) [582553-1](#) [0009485154](#) [009176003701906](#) [0050291907](#) [LY20-4P-DT1-P1E-BR](#) [02.125.8002.8](#)  
[609-3404](#) [61062-3](#) [61082-181009](#) [622-3653LF](#) [63453-116](#) [636-1030](#) [636-1427](#) [636-3427](#) [636-4007](#) [641938-9](#) [641991-4](#) [644827-2](#) [65817-](#)  
[010LF](#) [65817-015LF](#) [65863-015LF](#) [66207-023LF](#) [67095-007LF](#) [67601157](#) [68645-018](#) [68648-049](#) [70.362.1628.0](#) [70-4210](#) [70-4226B](#) [70-](#)  
[4853B](#) [707-5020](#) [707-5028](#) [71.350.2428.0](#) [71918-208LF](#) [71961-016LF](#) [733-134](#) [733-162](#) [754199-000](#) [760-3052](#) [79531-3000](#) [FCN-](#)  
[360C032-B](#) [FCN-367T-T012/H](#) [FCN-723D010/2](#) [80.063.4001.1](#) [800-90-010-10-002000](#) [801-43-002-10-013000](#) [801-43-006-10-002000](#)  
[801-93-011-10-001000](#)