

LOC
J

DIST

REVISIONS

| P | LTR | DESCRIPTION | DATE | DWN | APVD |
|---|-----|---------------------------|-----------|-----|------|
| | B1 | REVISED PER ECO-11-005140 | 09APR2011 | RK | HMR |

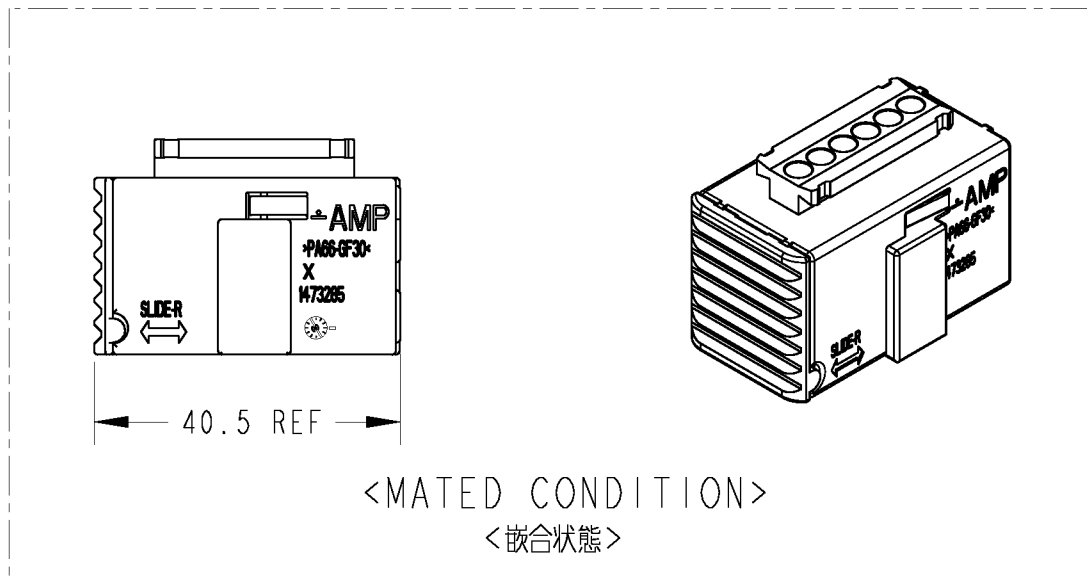

- 1. APPLICABLE SECONDARY LOCKING DEVICE : P/N X-1473288-X
- 2. APPLICABLE CONTACT : P/N 963711-2 (LOOSE PIECE)
: P/N 962876-2 (STRIP FORM)
- 3. MARKING TO IDENTIFY THE DIRECTION OF SLIDE

- 1. 適用 セカンドロックデバイス : 型番 X-1473288-X
- 2. 適用 端子 : 型番 963711-2 (バラ端子)
: 型番 962876-2 (リール端子)
- 3. スライド方向識別マーク

PART NUMBER : 1473284-1
SLIDE-R TYPE

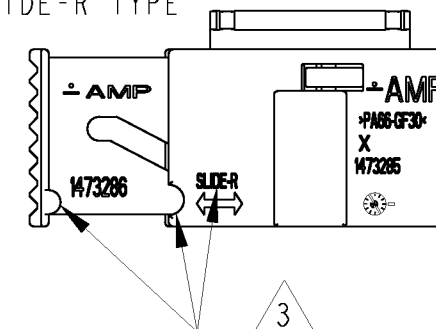

PART NUMBER : 1473284-2
SLIDE-L TYPE

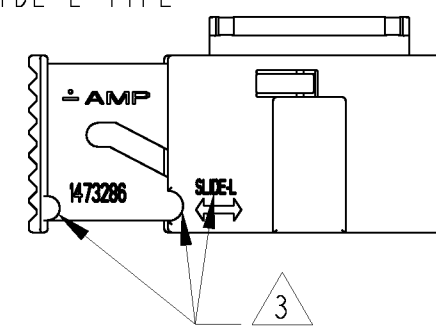
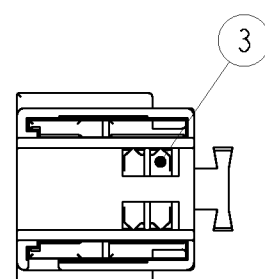
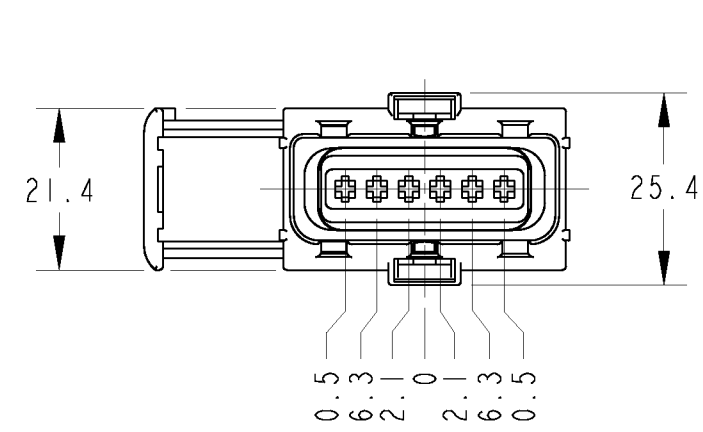
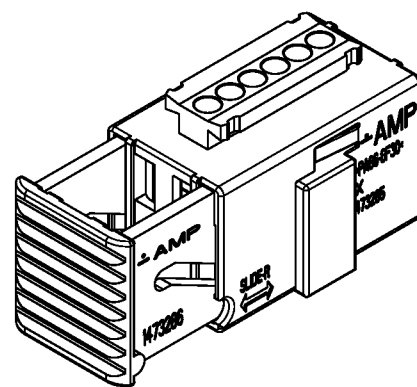
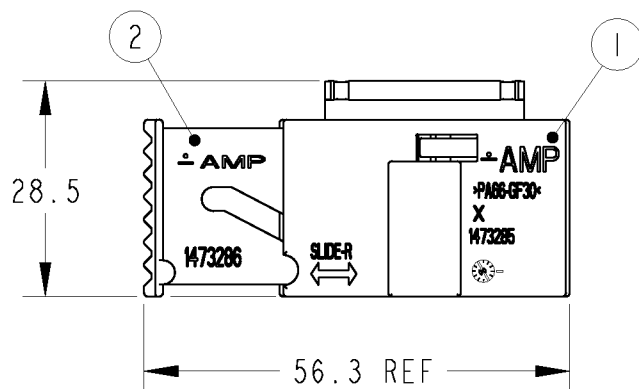

FIG.1



| | | | | | | |
|-----------------------|--------------------|--------------------|------------------|--------------------|-------------------------------|-------------------|
| PAPER BOX ダンボール | PAPER BOX ダンボール | RED 赤 | RED 赤 | BLACK 黒 | SLIDE-L TYPE (SEE FIG.1) | 1473284-2 |
| PAPER BOX ダンボール | PAPER BOX ダンボール | RED 赤 | RED 赤 | BLACK 黒 | SLIDE-R TYPE (SEE FIG.1) | 1473284-1 |
| OUTER 外装 | INNER 内装 | ③ SEALING シーリング | ② SLIDER スライダ | ① HOUSING ハウジング | DIRECTION OF SLIDER スライダ方向 | PART NUMBER 型番 |
| PACKING STYLE 梱包形態 | | COLOR 色 | | | | |

THIS DRAWING IS A CONTROLLED DOCUMENT.

| | |
|----------------------|---|
| DIMENSIONS: 単位: ㎜ | TOLERANCES UNLESS OTHERWISE SPECIFIED: ALL : ±0.5 |
| | 0-PLC ± |
| | 1-PLC ±0.5 |
| | 2-PLC ±0.13 |
| | 3-PLC ±0.013 |
| | 4-PLC ±0.000 |
| | ANGLES ±5'00" |
| MATERIAL 材料 | FINISH 仕上 |
| PA66 | SEE TABLE |

| | |
|----------------------------|-----------|
| DWN E. SASAKI | 14MAY01 |
| CHK T. KOHNO | 14MAY01 |
| APVD N. SAI | 15MAY01 |
| PRODUCT SPEC 製品規格 | 108-5757 |
| APPLICATION SPEC 取付適用規格 | 114-18081 |
| WEIGHT | 16 g |

| | | | |
|---|-----------|------------------|---------------|
| TE Connectivity | | | |
| NAME 名称 HOUSING ASSEMBLY , MICRO TIMER II 6POS. , NEUTRAL TYPE | | | |
| SIZE | CAGE CODE | DRAWING NO 番号 | RESTRICTED TO |
| A3 | 00779 | C=1473284 | |
| CUSTOMER DRAWING | | SCALE 尺度 | SHEET OF |
| | | | REV B1 |

X-ON Electronics

Largest Supplier of Electrical and Electronic Components

Click to view similar products for [Automotive Connectors](#) category:

Click to view products by [TE Connectivity](#) manufacturer:

Other Similar products are found below :

[003-018-000](#) [60403001](#) [60993906-B](#) [M902-2131](#) [M902-2161](#) [72.330.1035.1](#) [73.353.4028.0](#) [F119300-B](#) [F166900](#) [F258300-B](#) [F358300-B](#)
[F407400](#) [F444110](#) [F487000](#) [F509500B-B](#) [827153-1](#) [8N1515-32-24P](#) [9-1326729-8](#) [925474-1](#) [928905-1](#) [964562-4](#) [968782-1](#) [GT17SA-8DS-](#)
[HU](#) [98891-1012](#) [98947-1016](#) [12004147](#) [12004475-L](#) [12010290](#) [12010309-B](#) [12015454](#) [12020219-B](#) [12020308](#) [12041318-B](#) [12052225-L](#)
[12052466](#) [12059125](#) [12064869](#) [12004327-B](#) [12010503-B](#) [12015308](#) [12015384](#) [12015909](#) [1-21030-1](#) [12041254](#) [12041318](#) [12047946-B](#)
[12047957](#) [12047957-L](#) [12059473](#) [12066261](#)