



AMP

TE Internal #: 1490413-3

Portable Crimp Tools, Premium Crimp Tooling, Removable /Interchangeable, MIL Spec / TE Product Specification (114-), Manual / Battery / Hydraulic

[View on TE.com >](#)

Application Tooling > Portable Crimp Tools



Tool Grade: **Premium Crimp Tooling**

Die Sets Type: **Removable/Interchangeable**

Specification Type: **MIL Spec, TE Product Specification (114-)**

TE Certification: **Cannot be Certified**

Power Technology Type: **Battery, Hydraulic, Manual**

**Features**

**Other**

Crimp Form-Wire Barrel Type	Closed Barrel - W Crimp
Tool Grade	Premium Crimp Tooling
Die Sets Type	Removable/Interchangeable
Specification Type	MIL Spec, TE Product Specification (114-)
TE Certification	Cannot be Certified
Power Technology Type	Battery, Hydraulic, Manual
Tooling Type	Die Assembly

**Product Compliance**

[For compliance documentation, visit the product page on TE.com>](#)

EU RoHS Directive 2011/65/EU	Compliant
EU ELV Directive 2000/53/EC	Out of Scope
China RoHS 2 Directive MIIT Order No 32, 2016	No Restricted Materials Above Threshold
EU REACH Regulation (EC) No. 1907/2006	Current ECHA Candidate List: JUL 2021 (219) Candidate List Declared Against: JUL 2021 (219) Does not contain REACH SVHC
Halogen Content	Low Halogen - Br, Cl, F, I < 900 ppm per homogenous material. Also BFR/CFR/PVC

Free













Solder Process Capability

Not reviewed for solder process capability

Product Compliance Disclaimer

This information is provided based on reasonable inquiry of our suppliers and represents our current actual knowledge based on the information they provided. This information is subject to change. The part numbers that TE has identified as EU RoHS compliant have a maximum concentration of 0.1% by weight in homogenous materials for lead, hexavalent chromium, mercury, PBB, PBDE, DBP, BBP, DEHP, DIBP, and 0.01% for cadmium, or qualify for an exemption to these limits as defined in the Annexes of Directive 2011/65/EU (RoHS2). Finished electrical and electronic equipment products will be CE marked as required by Directive 2011/65/EU. Components may not be CE marked. Additionally, the part numbers that TE has identified as EU ELV compliant have a maximum concentration of 0.1% by weight in homogenous materials for lead, hexavalent chromium, and mercury, and 0.01% for cadmium, or qualify for an exemption to these limits as defined in the Annexes of Directive 2000/53/EC (ELV). Regarding the REACH Regulation, the information TE provides on SVHC in articles for this part number is based on the latest European Chemicals Agency (ECHA) 'Guidance on requirements for substances in articles' posted at this URL: <https://echa.europa.eu/guidance-documents/guidance-on-reach>

### Compatible Parts

 <p>TE Part # 31812 TERMINAL,SOLIS R 4 3/8</p>	 <p>TE Part # 33468 TERMINAL,SOLIS R 4 10</p>	 <p>TE Part # 35668 TERMINAL,SOLIS R 4 1/2</p>	 <p>TE Part # 327175 TERMINAL,SOLIS R 4 1/2</p>
 <p>TE Part # 320743 TERMINAL,SOLIS R 4 7/16</p>	 <p>TE Part # 34323 SPLICE,SOLIS BUTT 4</p>	 <p>TE Part # 33114 TERMINAL,SOLIS R 4 10</p>	 <p>TE Part # 33471 TERMINAL,SOLIS R 4 3/8</p>
 <p>TE Part # 31811 TERMINAL,SOLIS R 4 1/4</p>	 <p>TE Part # 33469 TERMINAL,SOLIS R 4 1/4</p>	 <p>TE Part # 33470 TERMINAL,SOLIS R 4 5/16</p>	 <p>TE Part # 160075 SOLIS 4 R M10</p>

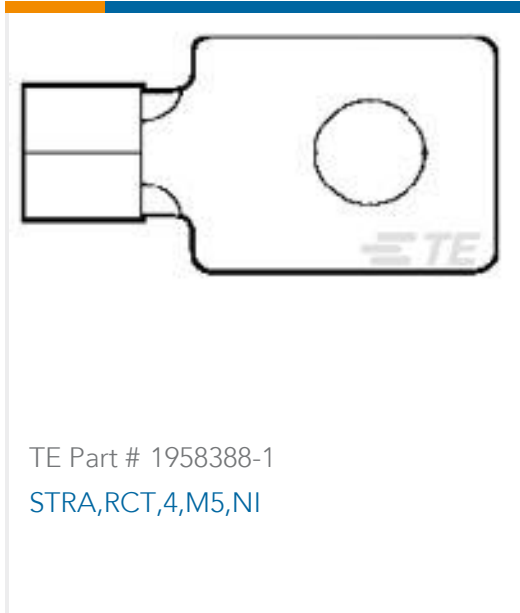

### Customers Also Bought

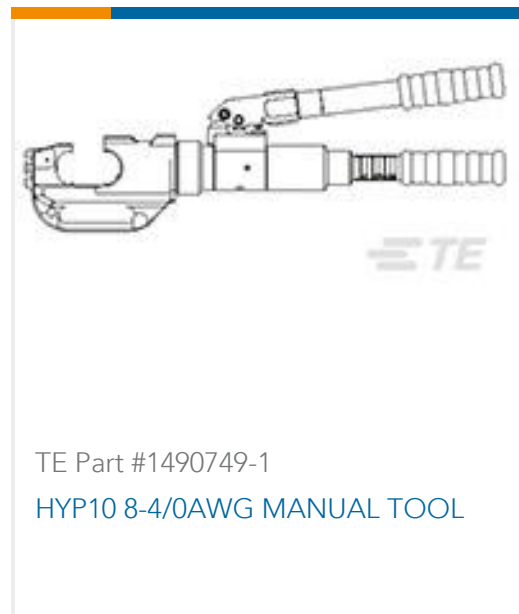
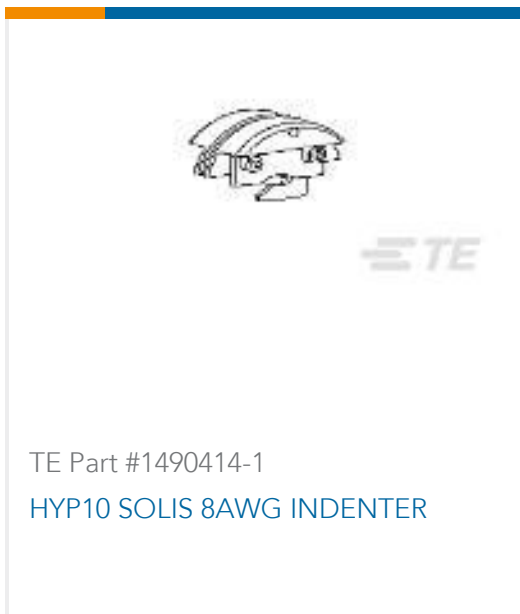
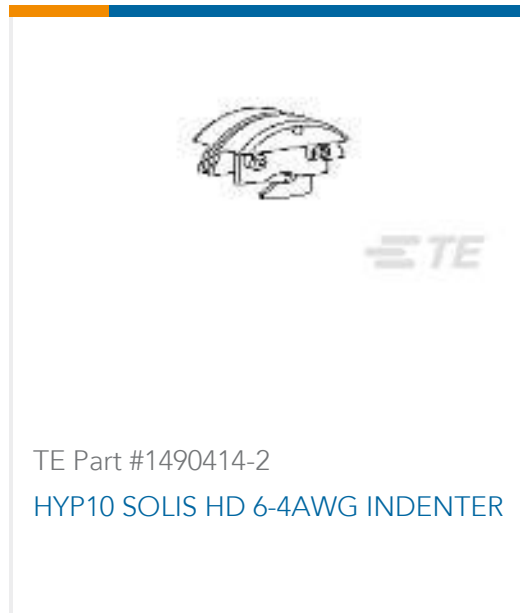

### Documents



### Datasheets & Catalog Pages

[Crimp Term Whitepaper-Use the Right Tool 1-1773953-1](#)

English

[CRIMPING WHERE FORM MEETS FUNCTION](#)

English

[Bottoming Dies](#)

English

---

### Instruction Sheets

[Instruction Sheet \(U.S.\)](#)

English

## **X-ON Electronics**

Largest Supplier of Electrical and Electronic Components

*Click to view similar products for [Punches & Dies](#) category:*

*Click to view products by [TE Connectivity](#) manufacturer:*

Other Similar products are found below :

[58510-1](#) [63454-1601](#) [63457-0056](#) [63457-3401](#) [730-5/8](#) [730BB-1-3/8](#) [PV-670508-001](#) [1328](#) [1338](#) [13782656](#) [13782673](#) [13782686](#) [AR-24](#)  
[1528-TL](#) [1583609-1](#) [1720](#) [1762951-1](#) [2063500-2](#) [19031-0168](#) [AR-20](#) [313336-3](#) [11-19-3122](#) [539663-1](#) [63446-2241](#) [TL-18](#) [0634451912](#)  
[1762674-1](#) [63454-0123](#) [68240-1](#) [68247-1](#) [734252](#) [313183-1](#) [PA2029](#) [119174-001](#) [23846-1](#) [11-40-5342](#) [68010-2](#) [690370015](#) [730BB-1-1/8](#)  
[730BB-1-1/16](#) [19032-0048](#) [63465-0023](#) [11-40-4438](#) [63457-0041](#) [2906252-01](#) [19032-0202](#) [11-11-0054](#) [11-11-0052](#) [19813-5041](#) [63863-2103](#)