



AMP

TE Internal #: 1490414-3

Portable Crimp Tools, Premium Crimp Tooling, Removable /Interchangeable, TE Product Specification (114-) / MIL Spec, Battery / Hydraulic / Manual

[View on TE.com >](#)

Application Tooling > Portable Crimp Tools



Tool Grade: **Premium Crimp Tooling**

Die Sets Type: **Removable/Interchangeable**

Specification Type: **MIL Spec, TE Product Specification (114-)**

TE Certification: **Cannot be Certified**

Power Technology Type: **Battery, Hydraulic, Manual**

Features

Other

Crimp Form-Wire Barrel Type	Closed Barrel - W Crimp
Tool Grade	Premium Crimp Tooling
Die Sets Type	Removable/Interchangeable
Specification Type	MIL Spec, TE Product Specification (114-)
TE Certification	Cannot be Certified
Power Technology Type	Battery, Hydraulic, Manual
Tooling Type	Die Assembly

Product Compliance

[For compliance documentation, visit the product page on TE.com>](#)

EU RoHS Directive 2011/65/EU	Compliant
EU ELV Directive 2000/53/EC	Out of Scope
China RoHS 2 Directive MIIT Order No 32, 2016	No Restricted Materials Above Threshold
EU REACH Regulation (EC) No. 1907/2006	Current ECHA Candidate List: JUL 2021 (219) Candidate List Declared Against: JAN 2018 (181) SVHC > Threshold: Not Yet Reviewed
Halogen Content	Low Halogen - Br, Cl, F, I < 900 ppm per



homogenous material. Also BFR/CFR/PVC Free













Solder Process Capability

Not reviewed for solder process capability

Product Compliance Disclaimer

This information is provided based on reasonable inquiry of our suppliers and represents our current actual knowledge based on the information they provided. This information is subject to change. The part numbers that TE has identified as EU RoHS compliant have a maximum concentration of 0.1% by weight in homogenous materials for lead, hexavalent chromium, mercury, PBB, PBDE, DBP, BBP, DEHP, DIBP, and 0.01% for cadmium, or qualify for an exemption to these limits as defined in the Annexes of Directive 2011/65/EU (RoHS2). Finished electrical and electronic equipment products will be CE marked as required by Directive 2011/65/EU. Components may not be CE marked. Additionally, the part numbers that TE has identified as EU ELV compliant have a maximum concentration of 0.1% by weight in homogenous materials for lead, hexavalent chromium, and mercury, and 0.01% for cadmium, or qualify for an exemption to these limits as defined in the Annexes of Directive 2000/53/EC (ELV). Regarding the REACH Regulation, the information TE provides on SVHC in articles for this part number is based on the latest European Chemicals Agency (ECHA) 'Guidance on requirements for substances in articles' posted at this URL: <https://echa.europa.eu/guidance-documents/guidance-on-reach>

Compatible Parts

 <p>TE Part # 322224 TERMINAL,SOLIS R 2/0 5/8</p>	 <p>TE Part # 321874 TERMINAL,SOLIS R 3/0 5/16</p>	 <p>TE Part # 320744 TERMINAL,SOLIS R 1/0 5/8</p>	 <p>TE Part # 321873 BODY SOLIS RING 2/0 1/2</p>
 <p>TE Part # 321867 TERMINAL SOLIS RING 1/0 5/16</p>	 <p>TE Part # 36921 TERMINAL,SOLIS R 2/0 1/4</p>	 <p>TE Part # 321271 TERMINAL,SOLIS R 4/0 5/16</p>	 <p>TE Part # 321868 TERMINAL SOLIS RING 1/0 3/8</p>
 <p>TE Part # 321877 TERMINAL,SOLIS R 3/0 1/2</p>	 <p>TE Part # 36934 BODY SOLIS RING 4/0 1/2</p>	 <p>TE Part # 321869 TERMINAL,SOLIS R 2/0 1/4</p>	 <p>TE Part # 36919 TERMINAL SOLIS RING 1/0 1/2</p>



TE Part # 36957
SPLICE,SOLIS BUTT 1/0



TE Part # 321878
TERMINAL,SOLIS R 4/0 3/8



TE Part # 36909
SPLICE,SOLIS PARA 3/0



TE Part # 36923
TERMINAL,SOLIS R 2/0 3/8



TE Part # 36925
TERMINAL,SOLIS R 2/0 1/2



TE Part # 321879
TERMINAL,SOLIS R 4/0 7/16



TE Part # 36918
TERMINAL,SOLIS R 1/0 7/16



TE Part # 36929
TERMINAL,SOLIS R 3/0 1/2

Customers Also Bought



TE Part #1490413-6
HYP10 SOLIS 2/0AWG NEST



TE Part #1490414-2
HYP10 SOLIS HD 6-4AWG INDENTER



TE Part #1490413-1
HYP10 SOLIS 8AWG NEST



TE Part #1490413-8
HYP10 SOLIS 4/0AWG NEST



TE Part #1490413-7
HYP10 SOLIS 3/0AWG NEST



TE Part #1490413-5
HYP10 SOLIS 1/0AWG NEST



TE Part #1490413-2
HYP10 SOLIS HD 8AWG NEST



TE Part #1490413-4
HYP10 SOLIS 2AWG NEST

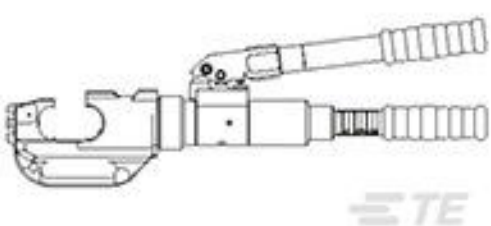

TE Part #1490749-1
HYP10 8-4/0AWG MANUAL TOOL



TE Part #1490748-1
HYP10 MANUAL TOOL

Documents



Datasheets & Catalog Pages

[AT-Hydraulic Crimp Tooling Solutions-1654519](#)

English

[Crimp Term Whitepaper-Use the Right Tool 1-1773953-1](#)

English

[CRIMPING WHERE FORM MEETS FUNCTION](#)

English

[Bottoming Dies](#)

English

Instruction Sheets

[Instruction Sheet \(U.S.\)](#)

English

X-ON Electronics

Largest Supplier of Electrical and Electronic Components

Click to view similar products for [Punches & Dies](#) category:

Click to view products by [TE Connectivity](#) manufacturer:

Other Similar products are found below :

[58510-1](#) [63454-1601](#) [63457-0056](#) [63457-3401](#) [730-5/8](#) [730BB-1-3/8](#) [PV-670508-001](#) [1328](#) [1338](#) [13782656](#) [13782673](#) [13782686](#) [AR-24](#)
[1528-TL](#) [1583609-1](#) [1720](#) [1762951-1](#) [2063500-2](#) [19031-0168](#) [AR-20](#) [CD5-8](#) [313336-3](#) [11-19-3122](#) [539663-1](#) [63446-2241](#) [TL-18](#)
[0634451912](#) [1762674-1](#) [63454-0123](#) [68240-1](#) [68247-1](#) [734252](#) [313183-1](#) [PA2029](#) [119174-001](#) [23846-1](#) [11-40-5342](#) [68010-2](#) [690370015](#)
[730BB-1-1/8](#) [730BB-1-1/16](#) [19032-0048](#) [63465-0023](#) [11-40-4438](#) [63457-0041](#) [2906252-01](#) [19032-0202](#) [11-11-0054](#) [11-11-0052](#) [19813-](#)
[5041](#)