

## Three Phase High Performance EMI Filter – Bookshelf Type Dual Stage DELTA Configuration

### DATASHEET

High performance filters with bookshelf design is designed for motor drive applications requiring minimum space and convenient installation with superior performance at significant interference levels.

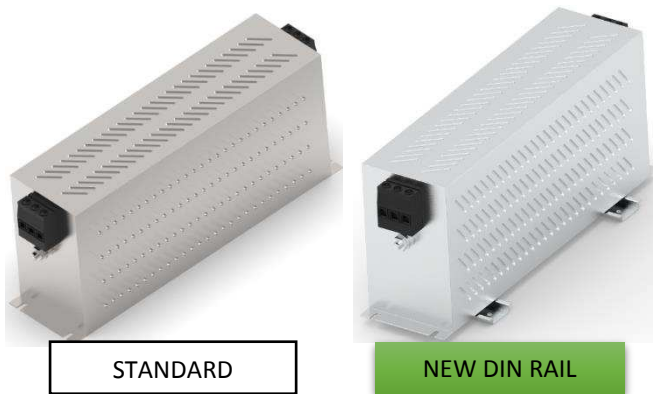

### Approvals & Compliance

UL Recognised

CSA Certified \*

\*30<sup>th</sup> June 2021



### Features

- High Performance
- Bookshelf Design
- Light Weight / Easy Installation
- Dual Stage

### Applications

- AC/Dc Drives
- HVAC
- Robotics
- UPS

### Typical Circuit Diagram

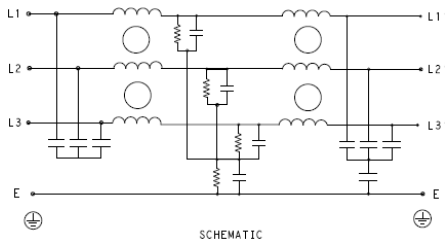

### Specifications

#### Electrical Characteristics

Maximum Continuous Operating Voltage	440/520VAC
Current Ratings	7A to 150A @40°C, Din Mount 7A to 100A @40°C
Operating Frequency	50/60Hz
High Potential Test Voltage -440VAC	Line to Ground 2632VDC for 1 Minute Line to Line 1892VDC for 1 Minute
High Potential Test Voltage -520VAC	Line to Ground 2856VDC for 1 Minute Line to Line 2236VDC for 1 Minute
Overload Capability	135% of Rated current for 15 minutes

#### Functional Characteristics

Operating Temperature Range	-25°C to +85°C
Climatic Category	25/85/21
Termination	Shock Proof
Flammability corresponding to	UL 94 V-0

#### Reference Standards

Design Corresponding to	UL 60939-3 and CSA 22.2 No.8-13
-------------------------	---------------------------------

# KEH-BS SERIES



## Selection Table -Standard Version



TE Ordering Number	Part Number	Rated Current @40°C	Rated Voltage @40°C	Leakage Current (mA)	Termination 	Weight (Kgs)
2-1609969-0	7KEHD10ABSD	7A	440 VAC	10	41	2
2-1609969-1	16KEHD10ABSD	16A	440 VAC	10	41	2
2-1609969-2	30KEHD10ABSD	30A	440 VAC	10	41	2
2-1609969-3	42KEHD10ABSD	42A	440 VAC	15	10	3
2-1609969-4	55KEHD10ABSD	55A	440 VAC	15	10	3
2-1609969-5	75KEHD10ABSD	75A	440 VAC	15	16	3
2-1609969-6	100KEHD10ABSD	100A	440 VAC	15	25	4
2-1609969-7	120KEHD10ABSD	120A	440 VAC	15	50	4
2-1609969-8	150KEHD10ABSD	150A	440 VAC	15	50	4
5-1609969-0	7KEHD10BBSD	7A	520 VAC	10	41	2
5-1609969-1	16KEHD10BBSD	16A	520 VAC	10	41	2
5-1609969-2	30KEHD10BBSD	30A	520 VAC	10	41	2
5-1609969-3	42KEHD10BBSD	42A	520 VAC	15	10	3
5-1609969-4	55KEHD10BBSD	55A	520 VAC	15	10	3
5-1609969-5	75KEHD10BBSD	75A	520 VAC	15	16	3
5-1609969-6	100KEHD10BBSD	100A	520 VAC	15	25	4
5-1609969-7	120KEHD10BBSD	120A	520 VAC	15	50	4
5-1609969-8	150KEHD10BBSD	150A	520 VAC	15	50	4

# KEH-BS SERIES



## Selection Table – Din Rail Mount



NEW

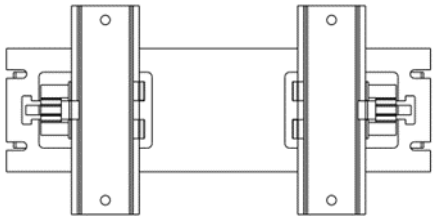
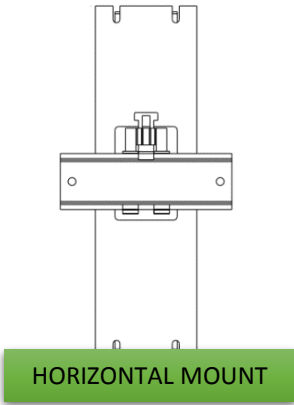

Note: Din Rail not supplied

TE Ordering Number	Part Number	Din Type	Rated Current @40°C	Rated Voltage @40°C	Leakage Current (mA)	Termination 	Weight (Kgs)
3-1609969-0	7KEHD10ABSDHM	HORIZONTAL	7A	440 VAC	10	41	2.1
3-1609969-1	16KEHD10ABSDHM	HORIZONTAL	16A	440 VAC	10	41	2.1
3-1609969-2	30KEHD10ABSDHM	HORIZONTAL	30A	440 VAC	10	41	2.1
3-1609969-3	7KEHD10ABSDVM	VERTICAL	7A	440 VAC	10	41	2.2
3-1609969-4	16KEHD10ABSDVM	VERTICAL	16A	440 VAC	10	41	2.2
3-1609969-5	30KEHD10ABSDVM	VERTICAL	30A	440 VAC	10	41	2.2
3-1609969-6	42KEHD10ABSDHM	HORIZONTAL	42A	440 VAC	15	10	3.2
3-1609969-7	55KEHD10ABSDHM	HORIZONTAL	55A	440 VAC	15	10	3.2
3-1609969-8	75KEHD10ABSDHM	HORIZONTAL	75A	440 VAC	15	16	3.2
3-1609969-9	100KEHD10ABSDHM	HORIZONTAL	100A	440 VAC	15	25	4.2
6-1609969-0	7KEHD10BBSDHM	HORIZONTAL	7A	520 VAC	10	41	2.1
6-1609969-1	16KEHD10BBSDHM	HORIZONTAL	16A	520 VAC	10	41	2.1
6-1609969-2	30KEHD10BBSDHM	HORIZONTAL	30A	520 VAC	10	41	2.1
6-1609969-3	7KEHD10BBSDVM	VERTICAL	7A	520 VAC	10	41	2.2
6-1609969-4	16KEHD10BBSDVM	VERTICAL	16A	520 VAC	10	41	2.2
6-1609969-5	30KEHD10BBSDVM	VERTICAL	30A	520 VAC	10	41	2.2
6-1609969-6	42KEHD10BBSDHM	HORIZONTAL	42A	520 VAC	15	10	3.2
6-1609969-7	55KEHD10BBSDHM	HORIZONTAL	55A	520 VAC	15	10	3.2
6-1609969-8	75KEHD10BBSDHM	HORIZONTAL	75A	520 VAC	15	16	3.2
6-1609969-9	100KEHD10BBSDHM	HORIZONTAL	100A	520 VAC	15	25	4.2

## Connectors Cross Section

	41	10	16	25	50
Wire Section (mm <sup>2</sup> )	4mm <sup>2</sup>	10 mm <sup>2</sup>	16 mm <sup>2</sup>	25 mm <sup>2</sup>	50 mm <sup>2</sup>
Wire Section (AWG)	12AWG	8 AWG	6 AWG	4 AWG	1/0 AWG
Wire Stripping	Max 10mm	max 13.5 mm	max 17 mm	max 17 mm	max 20 mm
Max Recommended Torque	0.5 Nm / 4.5 in.lbs	1.2 Nm / 10.8 in.lbs	2÷2.2 Nm / 18÷19.8 in.lbs	2 Nm / 18 in.lbs	6 Nm / 54 in.lbs

## Insertion Loss (Typical) – Measured in Closed 50Ω System

		Common Mode 50Ω / 50Ω								
		Frequency in MHz								
		0.01	0.05	0.15	0.5	1	3	5	10	30
Current Rating	7A	70	72	75	80	75	60	50	48	19
	16A	73	70	76	81	78	70	52	48	19
	30A	42	46	69	77	82	64	57	47	39
	42A	45	50	65	75	80	65	56	42	32
	55A	35	41	67	76	77	62	56	47	29
	75A	35	36	62	72	70	65	50	47	30
	100A	30	32	65	68	70	62	52	40	32
	120A	18	21	50	54	55	48	42	34	22
	150A	14	21	53	58	53	45	41	34	20

		Differential Mode 50Ω / 50Ω								
		Frequency in MHz								
		0.01	0.05	0.15	0.5	1	3	5	10	30
Current Rating	7A	45	50	33	47	50	48	38	22	65
	16A	30	45	33	47	49	65	50	22	65
	30A	18	24	57	81	87	60	45	17	25
	42A	18	24	50	70	84	60	45	19	26
	55A	22	23	25	82	78	59	46	23	26
	75A	25	24	28	65	75	60	46	26	24
	100A	26	28	30	62	72	60	46	26	24
	120A	28	30	60	52	43	32	26	20	19
	150A	33	38	64	51	43	32	26	20	19

## Common Mode Insertion Loss (Typical in dB – refer to Table above)

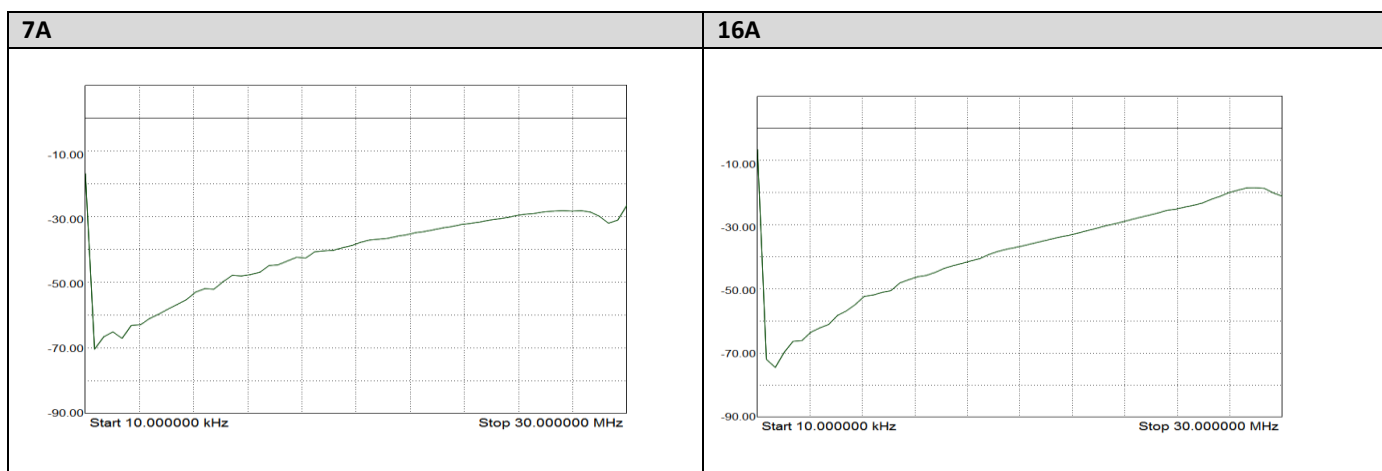

# KEH-BS SERIES

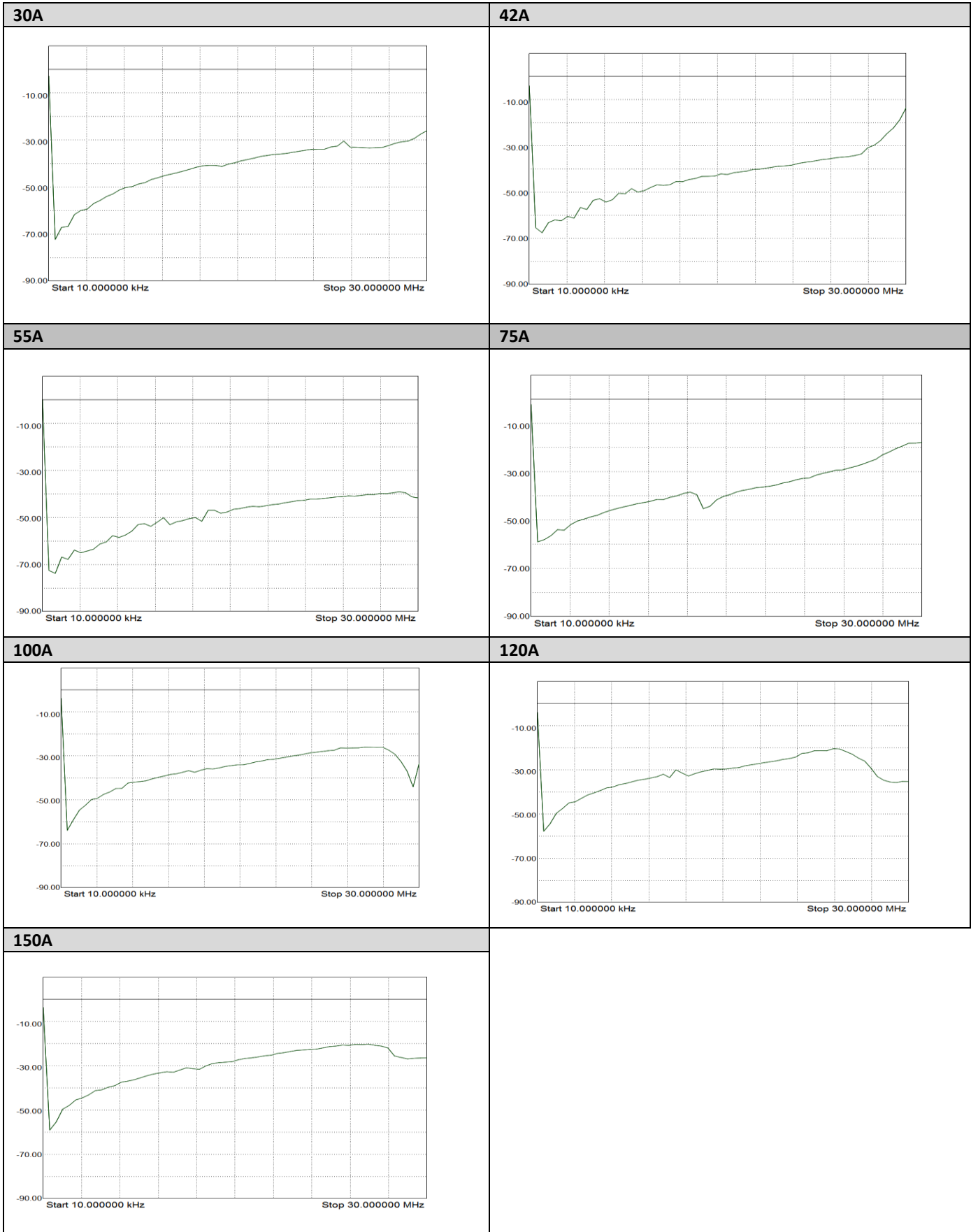

2376469-1  
Rev B  
Date: 30-Apr-2021

Dimensions in millimetres

Dimensions Shown for reference purposes only. Specifications subject to change

For Email, phone or live chat, go to: [www.te.com/help](http://www.te.com/help)

## Case Dimensions – Standard Version

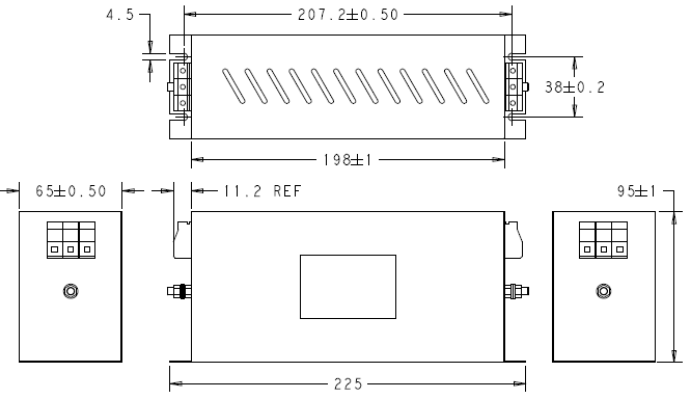
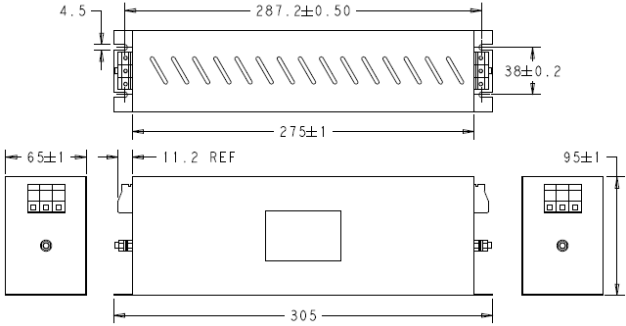
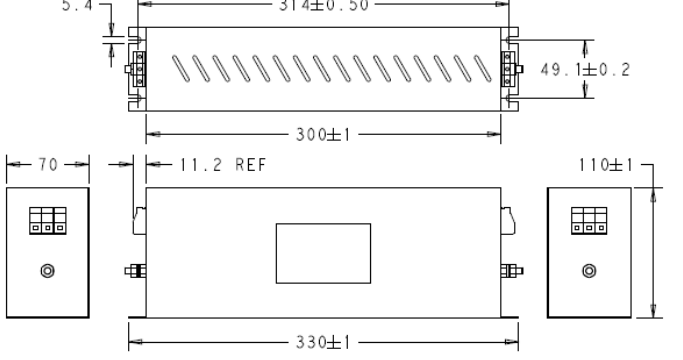
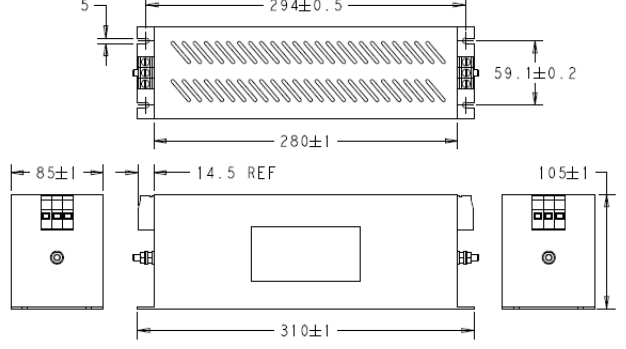
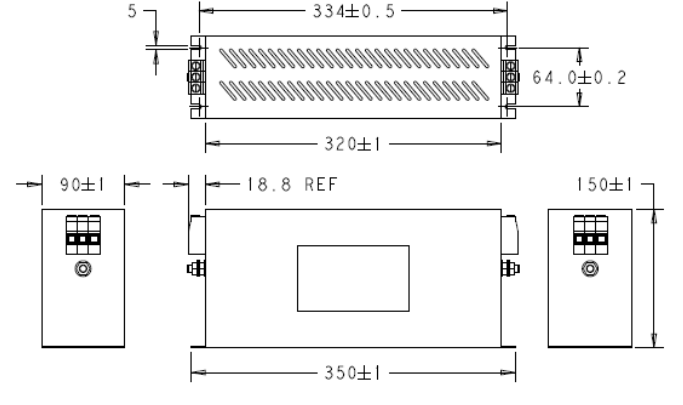
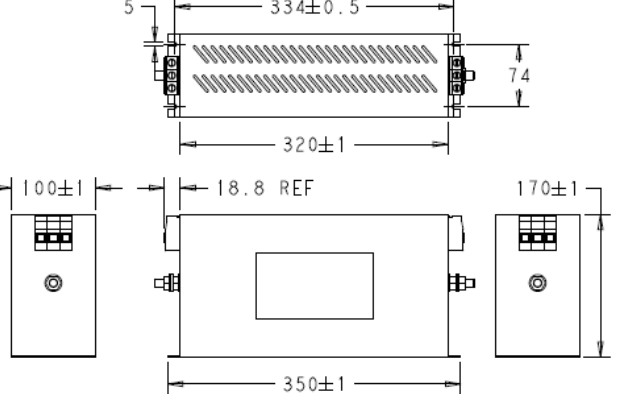
7A Shock Proof Type	16A Shock Proof Type
	
30A & 42A Shock Proof Types	55A Shock Proof Type
	
75A Shock Proof Type	100A Shock Proof Type
	

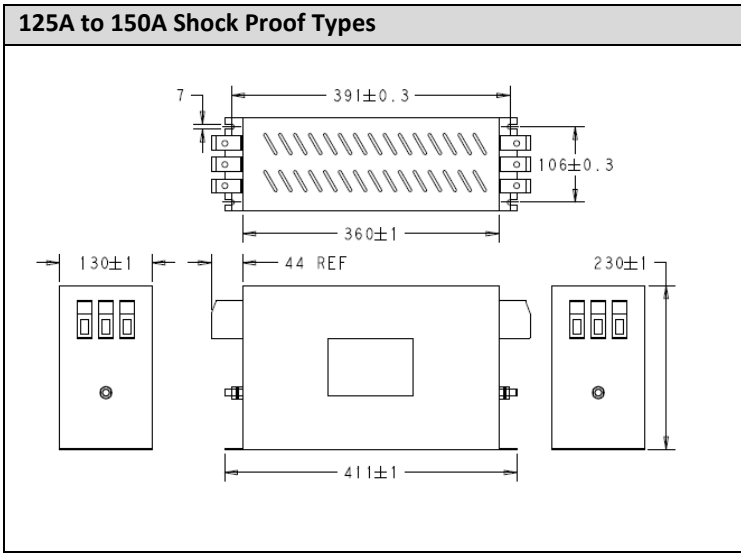

**Case Dimensions – Din Rail Mount**

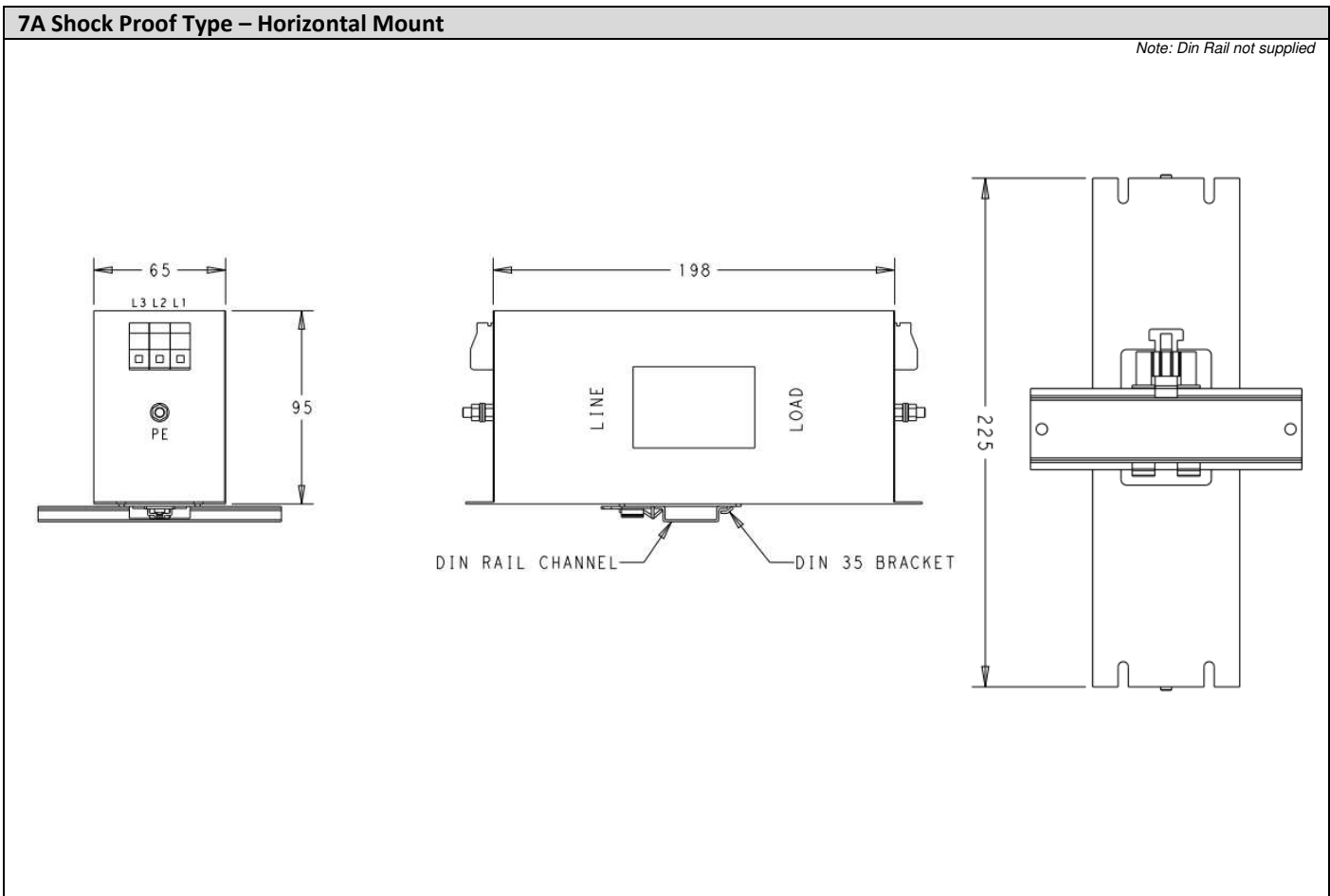

# KEH-BS SERIES



## 7A Shock Proof Type – Vertical Mount

Note: Din Rail not supplied

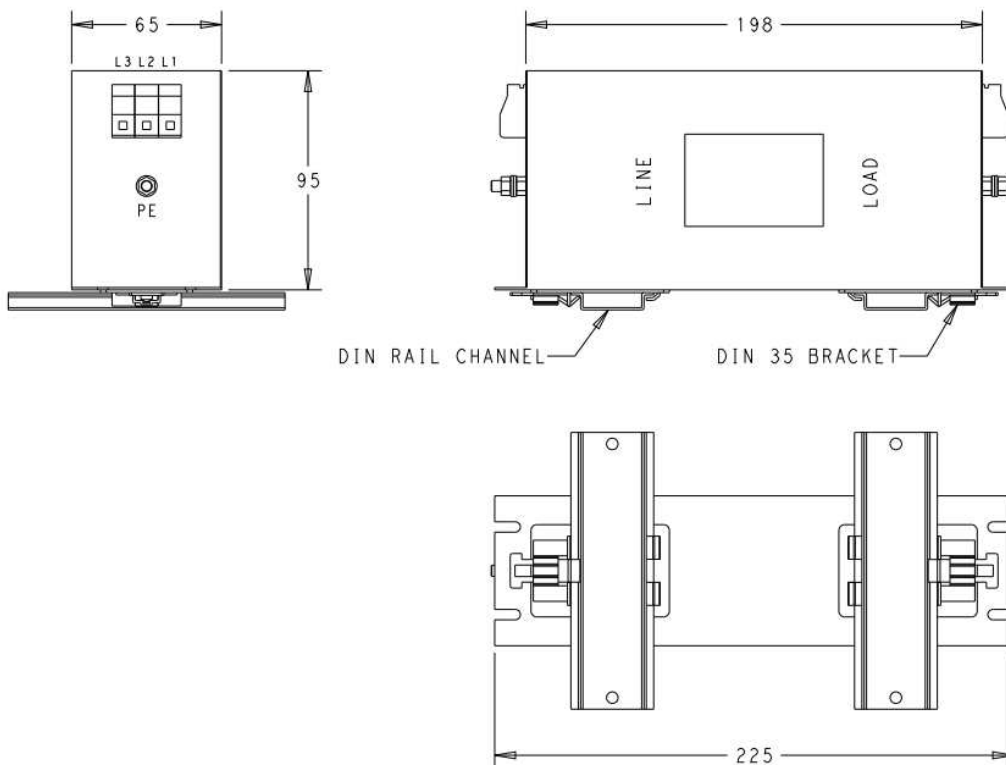

## 16A Shock Proof Type – Horizontal Mount

Note: Din Rail not supplied

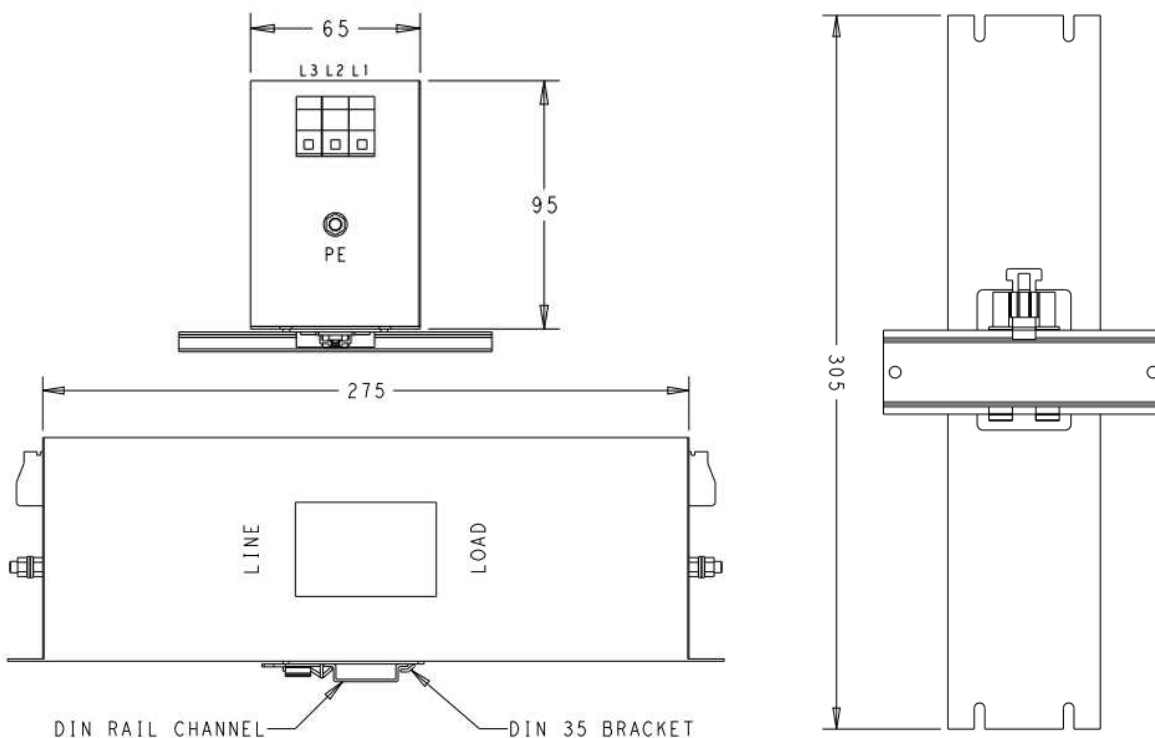



# KEH-BS SERIES



## 16A Shock Proof Type – Vertical Mount

Note: Din Rail not supplied

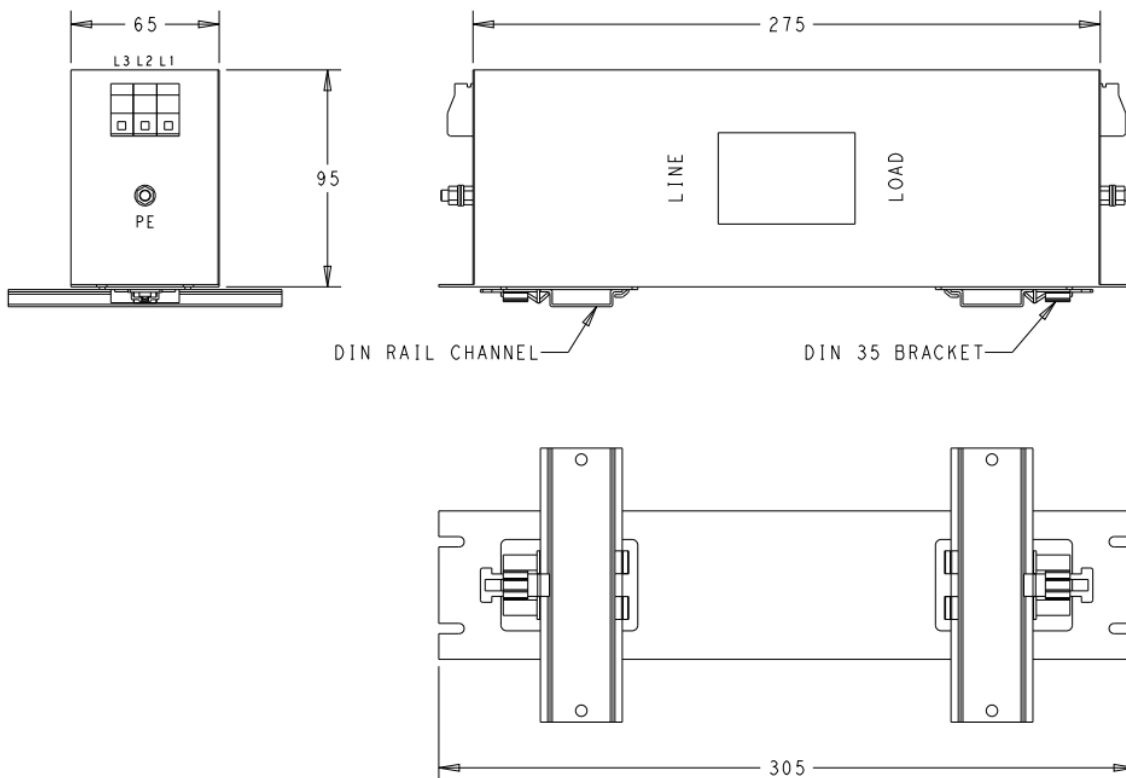

## 30A Shock Proof Type – Horizontal Mount

Note: Din Rail not supplied

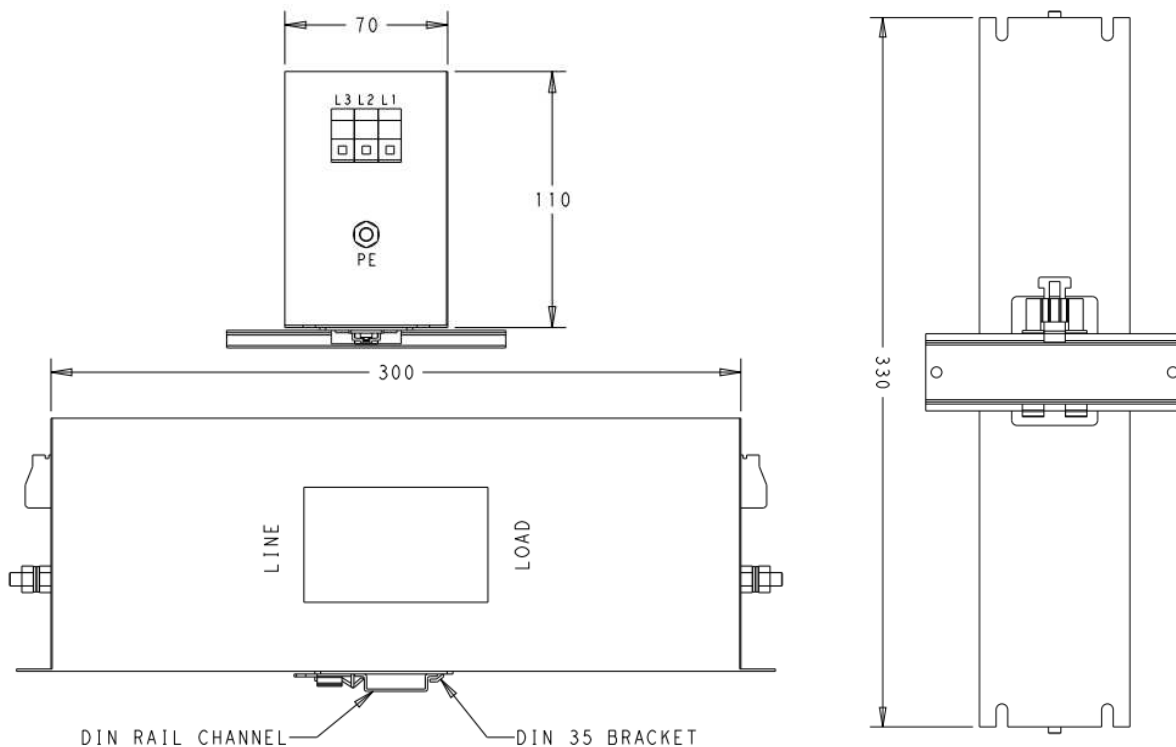

# KEH-BS SERIES



## 30A Shock Proof Types – Vertical Mount

Note: Din Rail not supplied

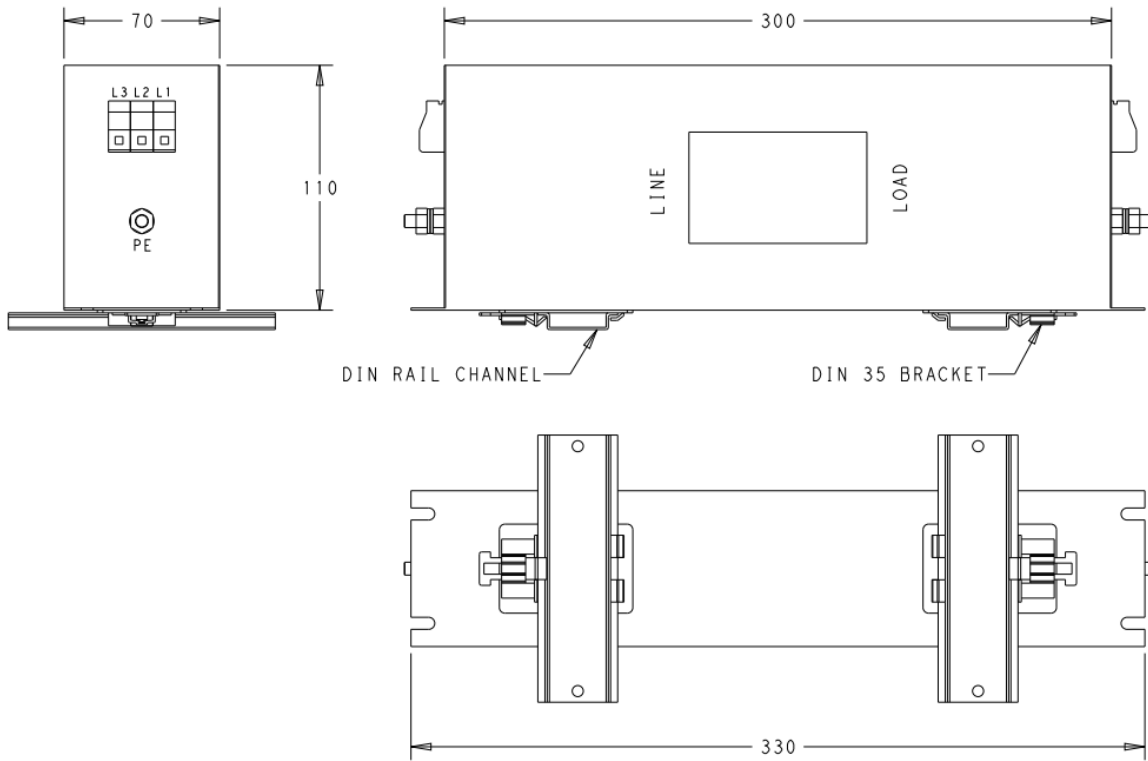

## 42A Shock Proof Type – Horizontal Mount

Note: Din Rail not supplied

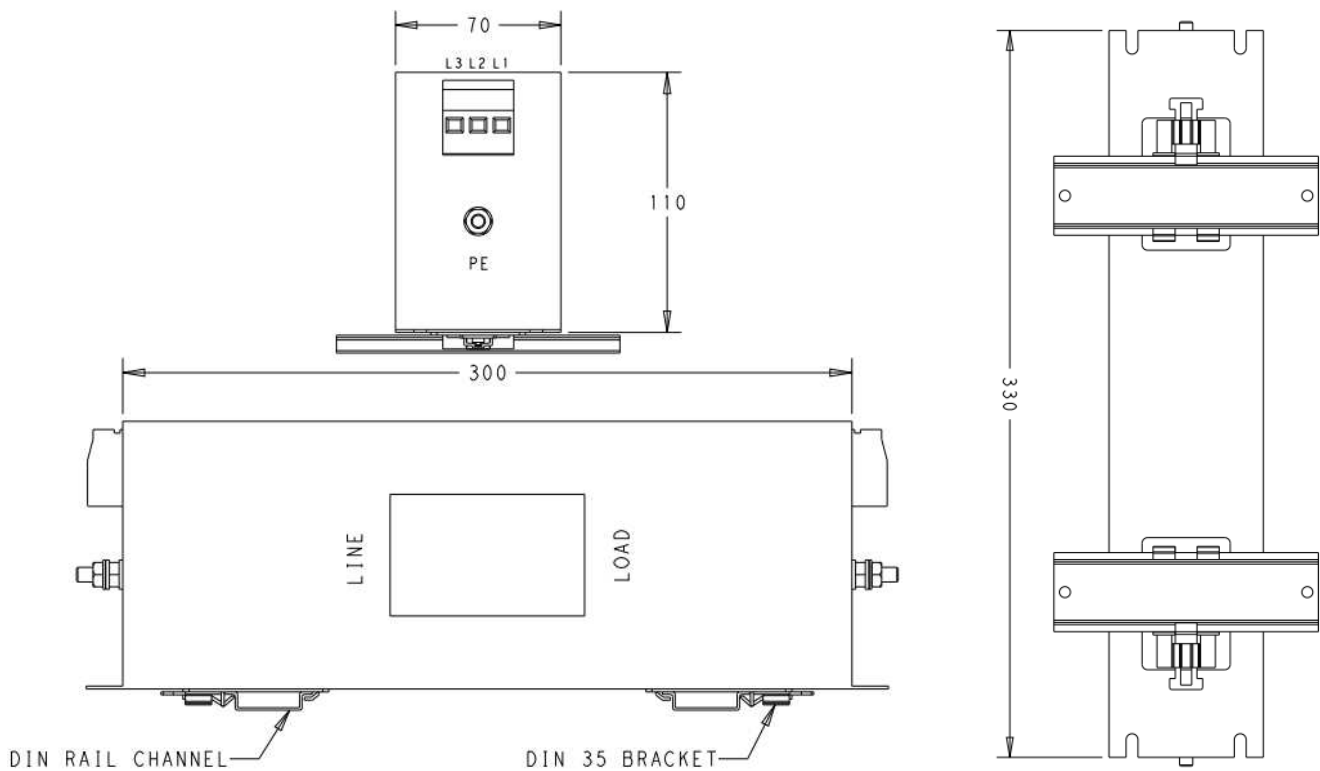

# KEH-BS SERIES



## 55A Shock Proof Type – Horizontal Mount

Note: Din Rail not supplied

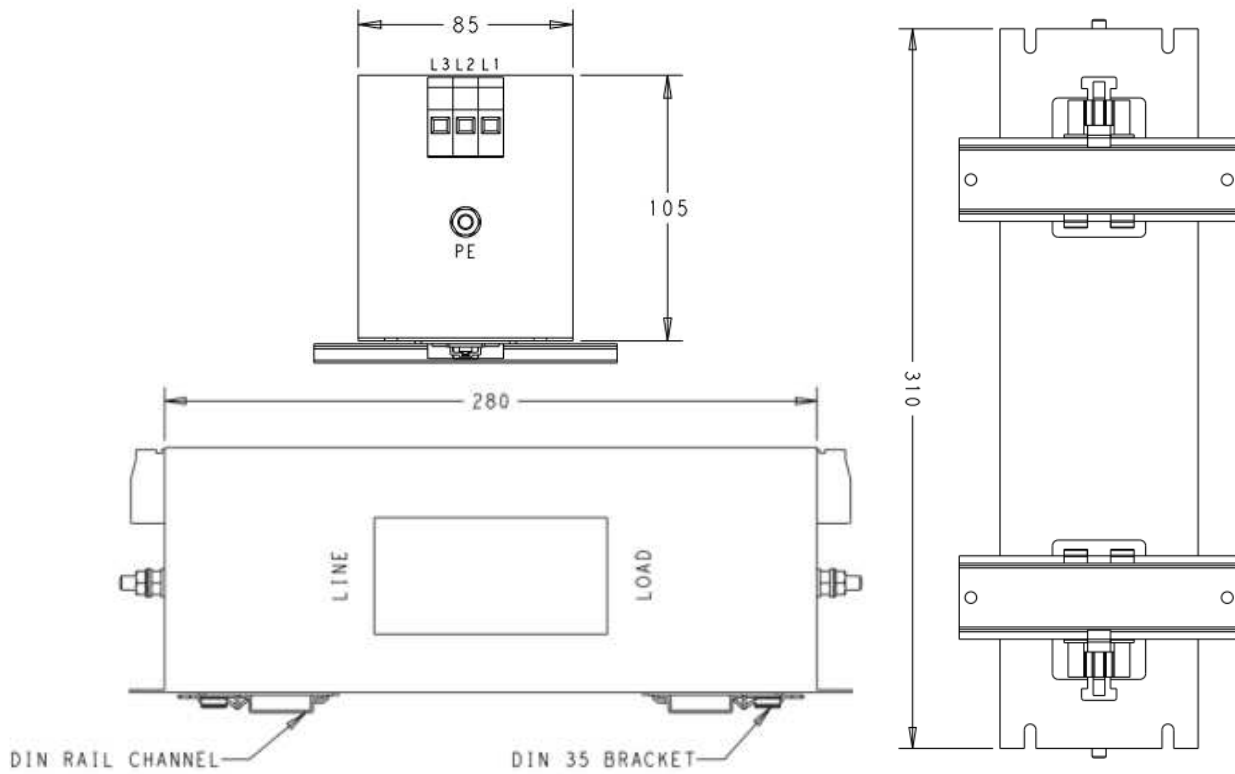

## 75A Shock Proof Type – Horizontal Mount

Note: Din Rail not supplied

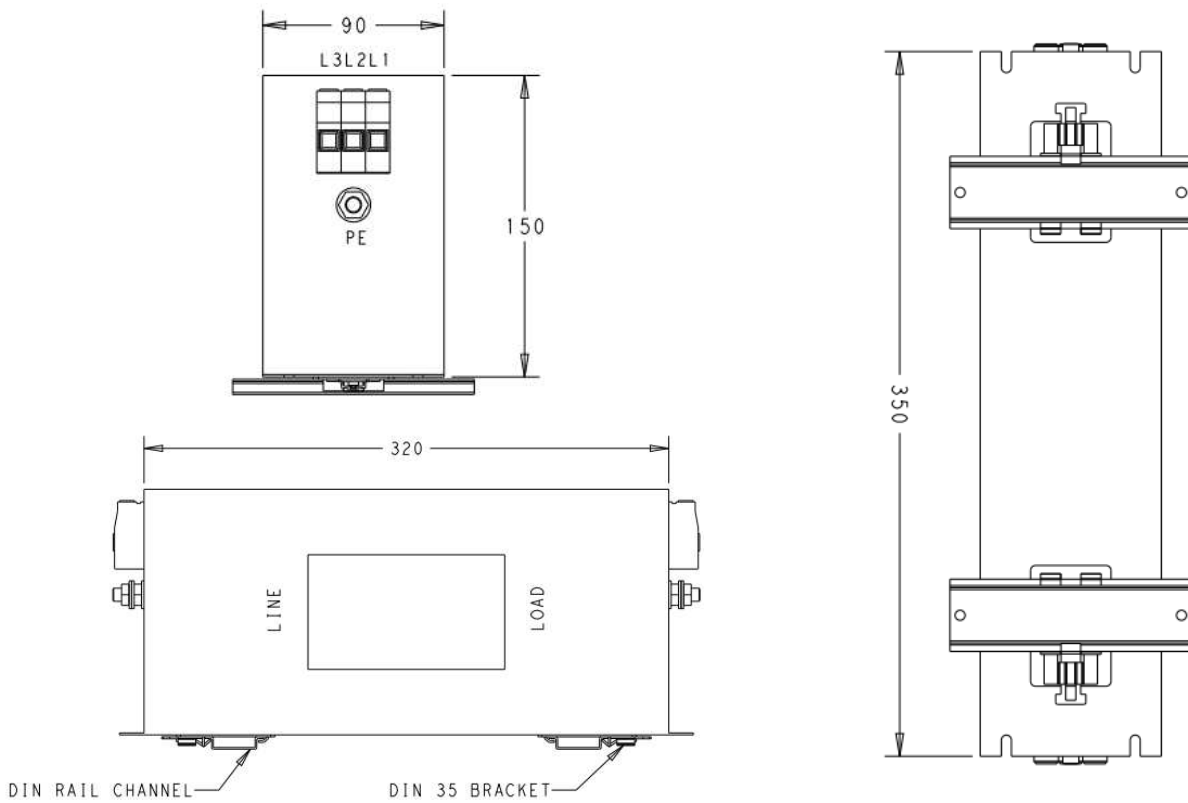

# KEH-BS SERIES



## 100A Shock Proof Type – Horizontal Mount

Note: Din Rail not supplied

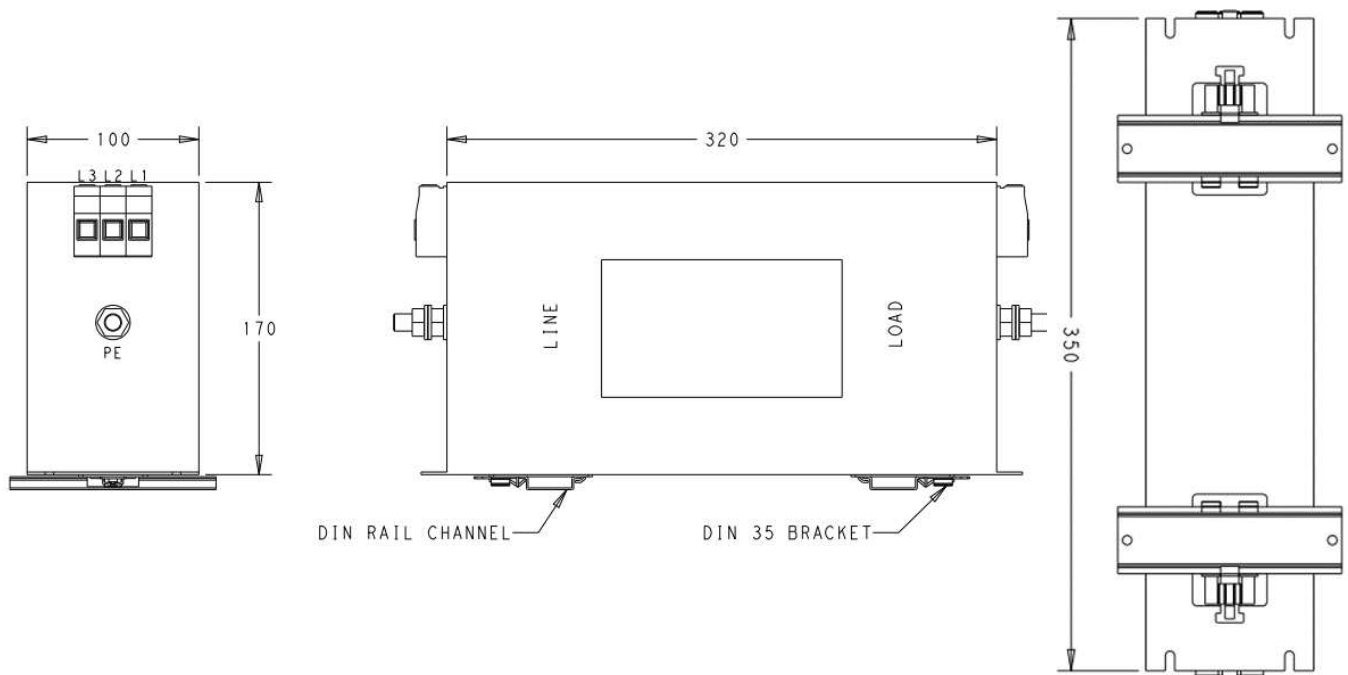

All dimensions in mm; Tolerances according: ISO2768-m

## How to Order

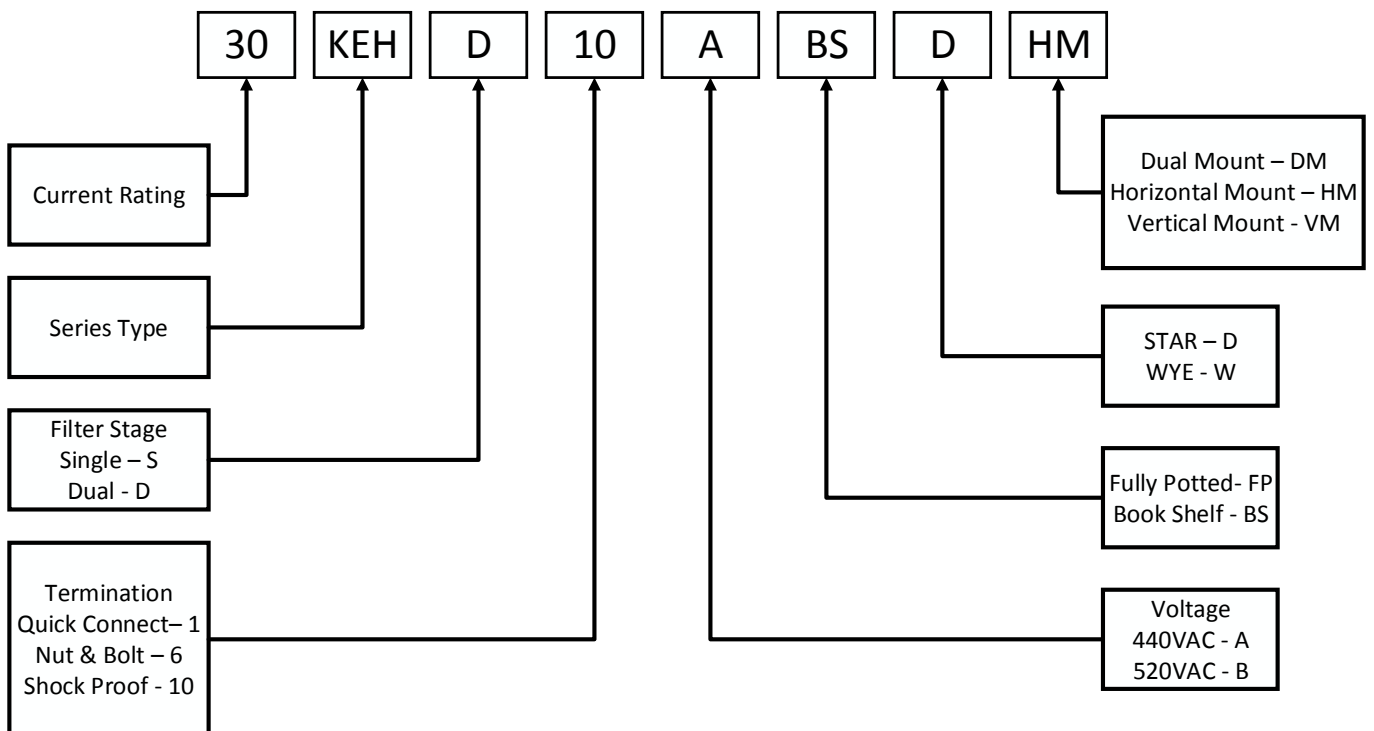

## X-ON Electronics

Largest Supplier of Electrical and Electronic Components

*Click to view similar products for [Power Line Filters](#) category:*

*Click to view products by [TE Connectivity](#) manufacturer:*

Other Similar products are found below :

[6609019-3](#) [6609026-5](#) [6609030-6](#) [6609973-2](#) [D30A](#) [7-1609090-5](#) [F2810](#) [F4456A](#) [F7382Z](#) [F7863Z](#) [FAHAV3100ZC000](#) [806276](#) [FN2020B-1-06](#) [FN2080B-10-06](#) [FN2410H-32-33](#) [FN2410H-80-34](#) [FP144](#) [FS4153-20-06](#) [FS4353-500-99](#) [12-MMB-030-11-D](#) [DB4-393](#) [15811T200](#) [20B1](#) [LC630](#) [2B1](#) [1609080-2](#) [1609993-8](#) [1-6609070-1](#) [F1100AA02](#) [F1150CC10](#) [F1500CA10](#) [F1500CA15](#) [F4041Z](#) [F7585E](#) [1B1](#) [FN2070A-16-06](#) [FN2090A-20-06](#) [FN2090B-12-06](#) [FN2090Z-1-06](#) [FN2410H-25-33](#) [FN2410H-60-34](#) [FN2410H-8-44](#) [FN2412H-8-44](#) [FN323B-6-01](#) [FN3258H-130-35](#) [FN610R-3-06](#) [20EHQ7](#) [20EHZ7](#) [20K1](#) [30B6](#)