



Pluggable Input / Output Solutions

RoHS
Ready 

te.com

© 2012 Tyco Electronics Corporation, a TE Connectivity Ltd. Company. All Rights Reserved.
1773408-1 LUG RRD 3M 5/2012
TE Connectivity and the TE connectivity (logo) are trademarks. Other logos, product and/or company names might be trademarks of their respective owners.



Table of Contents

Introduction to Pluggable I/O Interfaces	3, 4
SFP (Small Form-factor Pluggable) Products	5
zSFP+ Products	6, 7
SFP+ Products	8
SFP+ Single and Ganged Configurations	9
SFP+ Enhanced Single and Ganged Configurations	10, 11
SFP+ Stacked Configurations	12
SFP+ Copper Cable Assemblies	13, 14
SFP Single Port Cages and Connectors	15, 16
SFP Ganged (Single Row) Cages	17
SFP Stacked (Dual Row) Cage/Connector Assemblies	18, 19
SFP Cages with Integrated Connectors	20
SFP Cages with Riding Heat Sinks	21
SFP Copper Cable Assemblies	22
LC Optical Connectors and Cable Assemblies	23, 24
10 Gigabit Fiber Optic Products Overview	25
QSFP (Quad Small Form-factor Pluggable) Products	26
zQSFP+ Products	27, 28
QSFP+ Copper Cable Assemblies	29
QSFP/QSFP+ Products	30
QSFP Cages and Connectors	31, 32
MPO Optical Connectors and Cable Assemblies	33
QSFP+ PARALIGHT Active Optical Cable Assemblies	34-36
CFP Products	37
CXP Products	38, 39
XFP Products	40
X2 Standard Guide Rails and Connectors	41
Mini SAS HD Receptacle Assembly	42, 43
Mini SAS HD Copper Cable Assembly Part Number Selection Guide	43
Mini SAS High Speed Interconnect and Cable Assemblies	44
Part Number Index	45

Disclaimer

While TE has made every reasonable effort to ensure the accuracy of the information in this catalog, TE does not guarantee that it is error-free, nor does TE make any other representation, warranty or guarantee that the information is accurate, correct, reliable or current. TE reserves the right to make any adjustments to the information contained herein at any time without notice. TE expressly disclaims all implied warranties regarding the information contained herein, including, but not limited to, any implied warranties of merchantability or fitness for a particular purpose. The dimensions in this catalog are for reference purposes only and are subject to change without notice. Specifications are subject to change without notice. Consult TE for the latest dimensions and design specifications.

© 2012, 2009, 2006, and 2004 Tyco Electronics Corporation. All Rights Reserved.

AMP, EVERCLEAR, INFINITWIST, MADISON CABLE, MT-RJ SECURE, PARALIGHT, TURBOTWIN, TE Connectivity and the TE connectivity (logo) are trademarks of the TE Connectivity Ltd. family of companies.

Fibre Channel is a trademark of the Fibre Channel Industry Association.

INFINIBAND is a trademark of the InfiniBand Trade Association.

PCI is a trademark of PCI-SIG.

XAUI is a trademark of the 10Gigabit Ethernet Alliance XAUI Interoperability Group.

Other logos, product and Company names mentioned herein may be trademarks of their respective owners.

Restriction on the use of Hazardous Substances (RoHS)

At TE, we're ready to support your RoHS requirements. We've assessed more than 1.5 million end items/components for RoHS compliance, and issued new part numbers where any change was required to eliminate the restricted materials. Part numbers in this catalog are identified as:

RoHS Compliant — Part numbers in this catalog are RoHS Compliant, unless marked otherwise. These products comply with European Union Directive 2002/95/EC as amended 1 January 2006 that restricts the use of lead, mercury, cadmium, hexavalent chromium, PBB, and PBDE in certain electrical and electronic products sold into the EU as of 1 July 2006.

NOTE: For purposes of this Catalog, included within the definition of RoHS Compliant are products that are clearly "Out of Scope" of the RoHS Directive such as hand tools and other non-electrical accessories.

NOTE: Information regarding RoHS compliance is provided based on reasonable inquiry of our suppliers and represents our current actual knowledge based on the information provided by our suppliers. This information is subject to change. For latest compliance status, refer to our website referenced at right.

Getting the Information You Need

Our comprehensive on-line RoHS Customer Support Center provides a forum to answer your questions and support your RoHS needs. A RoHS FAQ (Frequently Asked Questions) is available with links to more detailed information. You can also submit RoHS questions and receive a response within 24 hours during a normal work week. The Support Center also provides:

- Cross-Reference from Non-compliant to Compliant Products
- Ability to browse RoHS Compliant Products in our on-line catalog
- Downloadable Technical Data Customer Information Presentation
- More detailed information regarding the definitions used above
- So whatever your questions when it comes to RoHS, we've got the answers at www.te.com/leadfree

RoHS
Customer
Support
Center

Introduction

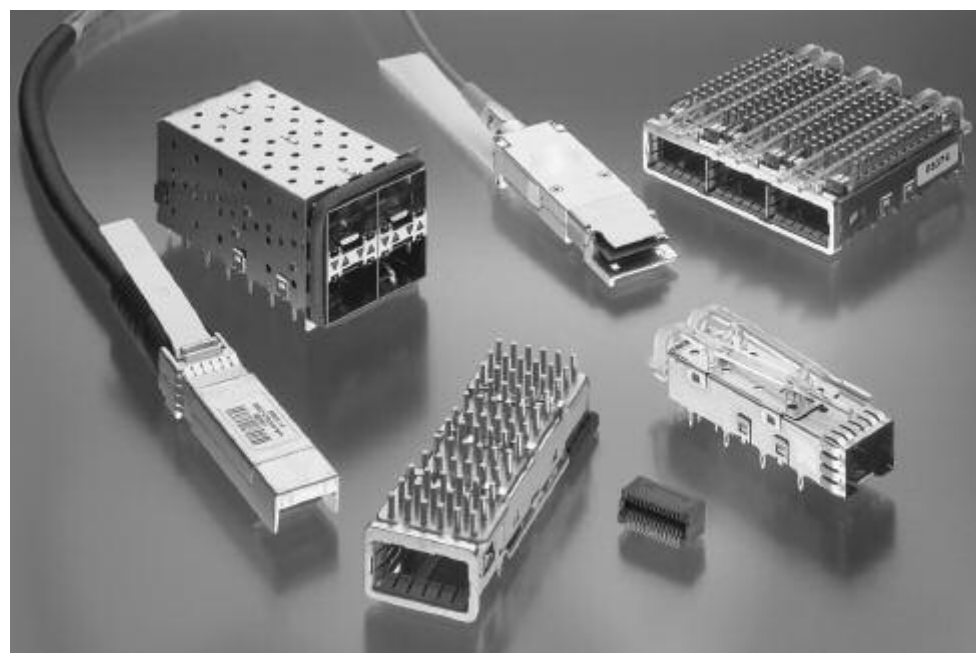

The pluggable I/O interface offers significant advantages as a high speed I/O interconnect. With a standard equipment I/O interface and the flexibility of pluggable modules come the options for fiber and copper links, and various data rates and protocols.

TE Connectivity is a leader in the development of pluggable I/O standards. TE continues to be engaged in new pluggable interface standards to support the rapidly changing market needs for higher bandwidth, and remains an industry leader with the technical expertise required to deliver superior designs for signal integrity and EMI at higher data rates.

TE offers a complete SFP product line, including single port and higher density multi-port SFP cages in single row and stacked configurations. As the market's demand for increased functionality and higher data rates continued to grow, TE introduced new options, including integrated light-pipes for port indicators, connectors with improved signal integrity, enhanced EMI springs for increased EMI suppression, and patented riding heat sink technology for thermal management.

As data rates reached 10 Gigabits per second, TE took an active role in developing the 10 Gigabit Serial (XFP) standard and the X2 MSA, the XAUI-

based 10 Gigabit solution. Increased protocol speeds led to the development of the SFP+ interface, which extends the SFP form factor to support applications up to 16 Gb/s, such as 8G and 16G Fibre Channel and 10G Ethernet. Enhanced EMI springs and elastomeric gaskets are used to address EMI containment at the higher data rates.

To address market needs for greater density in a high speed pluggable solution, the QSFP+ (Quad Small-Form Factor Pluggable) interface was developed, providing a 4-channel 40Gb/s pluggable interface. Key demonstrated technologies from XFP were adopted in this design.

For a full overview of the TE pluggable interfaces with data sheets and part search capability, visit www.te.com/products/pluggableIO

Fibre Channel is a trademark of the Fibre Channel Industry Association.

XAUI is a trademark of the 10Gigabit Ethernet Alliance XAUI Interoperability Group.

Introduction (Continued)

Applications for Pluggable I/O Interfaces

Application	Data Rate	Pluggable Interface										
		SFP	XFP	X2	XPAK Standard	Xenpak Standard	SFP+	QSFP	CFP	CXP	Mini SAS	Mini SAS HD
Fibre Channel	1G	X										
	2G	X										
	4G	X					X					
	8G						X					
	16G						X					
Ethernet	1G	X										
	10G		X	X	X	X	X	X				
	40G							X	X			
	100G								X	X		
InfiniBand Standard	2.5G	X										
	5G	X					X					
	10G				X		X					
	20G							X				
	40G							X	X			
	100G								X			
	125G									X		
SAS Standard	3G										X	
	6G										X	X
	12G											X
	24G											

Components of a pluggable I/O interface

A pluggable interface consists of:

- a board-mount connector
- a cage or guide rail which provides EMI containment and guidance for the mating plug
- a mating plug, which may be in the form of a pluggable transceiver, or direct attach cable assembly. A transceiver requires a mating cable assembly.

Accessories include heat sinks and retaining clips, lightpipes, dust plugs and EMI plugs.

Illustration below shows a QSFP application:

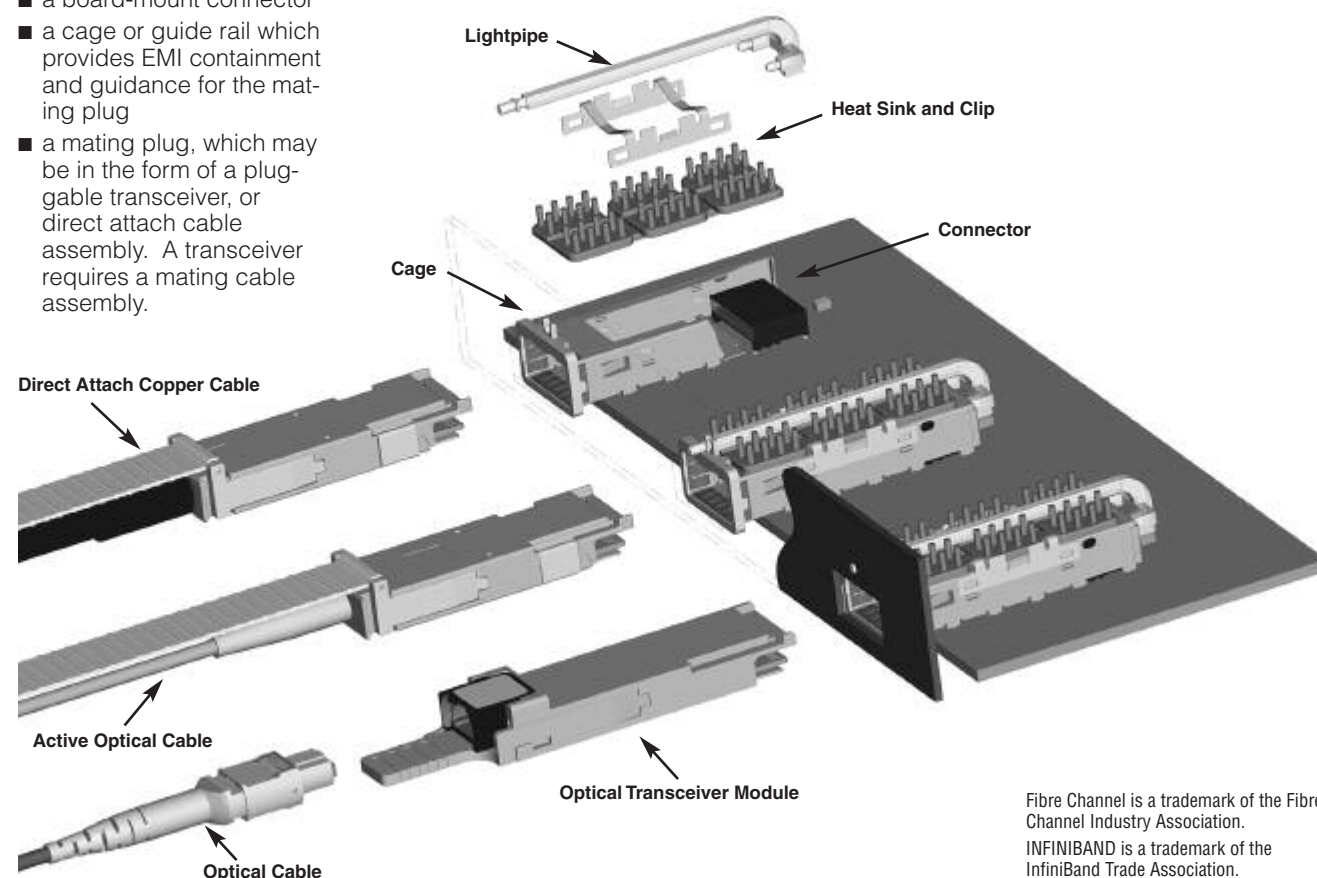

Fibre Channel is a trademark of the Fibre Channel Industry Association.
 INFIBAND is a trademark of the InfiniBand Trade Association.

SFP (Small Form-factor Pluggable) Products

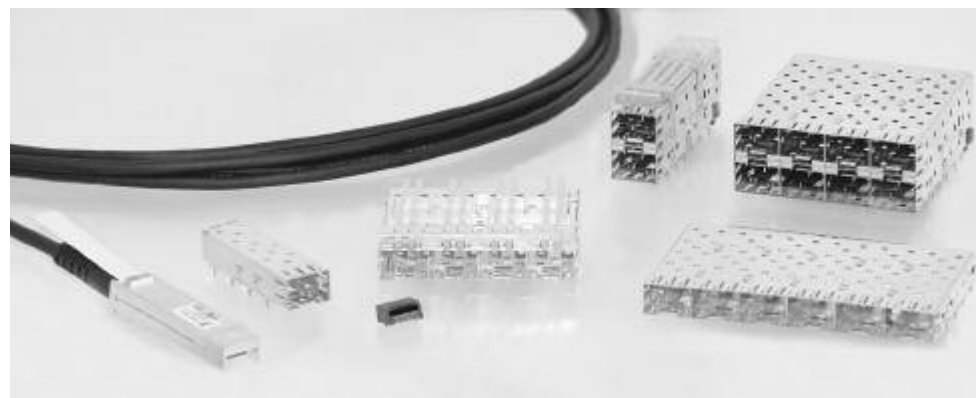

As a founding member and innovator for the Small Form-factor Pluggable (SFP) Multi-Source Agreement (MSA), TE supports the market with a full range of SFP products. SFP products include zSFP+, SFP+, SFP+ Enhanced and SFP connectors, cage assemblies and connector assemblies.

From the original 20 position pluggable transceiver (PT) connector and single port cage, the product has expanded rapidly to include many other options to increase functionality and meet increasing bandwidth demands. The newly released zSFP+ product line takes data rates to 25G/s.

Lightpipes:

TE provides a complete line of lightpipes for single cages, ganged (single row), and stacked (double row) cages across all the SFP products.

Enhanced EMI:

As the data rates using the SFP form factor increase, the need for increased EMI suppression becomes imperative. Addressing both cabinet and module generated noise, the SFP products offer both external spring or elastomeric gasket options for EMI suppression.

Heat Sinks:

TE addresses the need for increased thermal dissipation by incorporating patented riding heat sink technology. The riding heat sinks use direct contact to the pluggable module to draw heat away from its source.

zSFP+ Products

Single Port SMT

- zSFP+ SMT 20-circuit connectors and cage assemblies provide excellent signal integrity and Electro Magnetic Interference (EMI) protection
- zSFP+ SMT 20-circuit connector supports current 10 Gbps ethernet and 16 Gbps Fibre Channel applications
- The zSFP+ connector shares the same PCB footprint, mating interface and EMI cage dimensions as the standard SFP+ form factor, making it backward compatible. zSFP+ SMT interconnect can be used as a drop-in replacement for current SFP+ designs
- Single-port and ganged cages are available to support multiple design options
- Cage press-fit tails accommodate belly-to-belly applications to provide the best use of PCB space
- Cages are offered with optional lightpipes and heat sinks
- A conductive EMI plug is available to reduce EMI leakage through an empty (unused) cage port



TE next generation high speed I/O pluggable products are designed to transmit 25+ Gbps data rates, provide excellent EMI protection and high-level of heat dissipation.

zSFP+ and zQSFP+ interconnect systems deliver superior signal integrity performance for next generation ethernet, InfiniBand and Fibre Channel applications.

Part Number	Description
2170088-2	zSFP+ SMT Connector

Lightpipe Option	1X1	1X2	1X4	1X6
No	2198709-1	2198720-1	2198722-1	2198724-1
Yes	2198708-1	2198719-1	2198721-1	2198723-1

Fibre Channel is a trademark of the Fibre Channel Industry Association.

INFINIBAND is a trademark of the InfiniBand Trade Association.

Note: All part numbers are RoHS compliant.

zSFP+ Products (Continued)

Dual Port Press-fit

- High-port-density 25 Gbps data rate connectors offer complete integration of the connector within a cage
- Include optional lightpipes to provide port-status indication to the user
- Two rows of belly-to-belly vertically stacked zSFP+ ports come in 2x1, 2x2, 2x4, 2x6, and 2x8 configurations
- Elastomeric or metal sprig-finger gaskets provide excellent Electro Magnetic Interference (EMI) protection
- Accept SFP MSA-compliant modules, allowing installers to configure and upgrade high-speed Ethernet and Fibre Channel (FC) ports
- A conductive EMI plug is available to reduce EMI leakage through an empty (unused) cage port



Lightpipe Configuration	2X1	2X2	2X4	2X6	2X8
None	2198318-1	2198325-1	2180324-1	2198339-1	2198346-1
All 4	2198318-2	2198325-2	2180324-2	2198339-2	2198346-2
Inner	2198318-3	2198325-3	2180324-3	2198339-3	2198346-3
Outer	2198318-4	2198325-4	2180324-4	2198339-4	2198346-4

SFP+ Products

Product Facts

- SFP+ interconnect system supports data rates up to 16 Gb/s
- Connector designed to support up to 16 Gb/s+ signal speeds, backward compatible with SFP
- Both EMI spring and gasket options for cages provide excellent shielding
- All cage configurations are offered with lightpipes for LED applications
- Heat sink optional for single port cages
- Cages are available for PCI card applications (one degree mounting angle)
- Cages accommodate belly-to-belly mounting
- Stacked cages include integrated high speed connector using patented wafer construction
- Active and passive copper cable assemblies provide a cost-effective solution for short reach applications

Applications

- Storage
- Servers
- Networking
- Switches
- Routers
- Hubs
- Network Interface Cards (NICs)

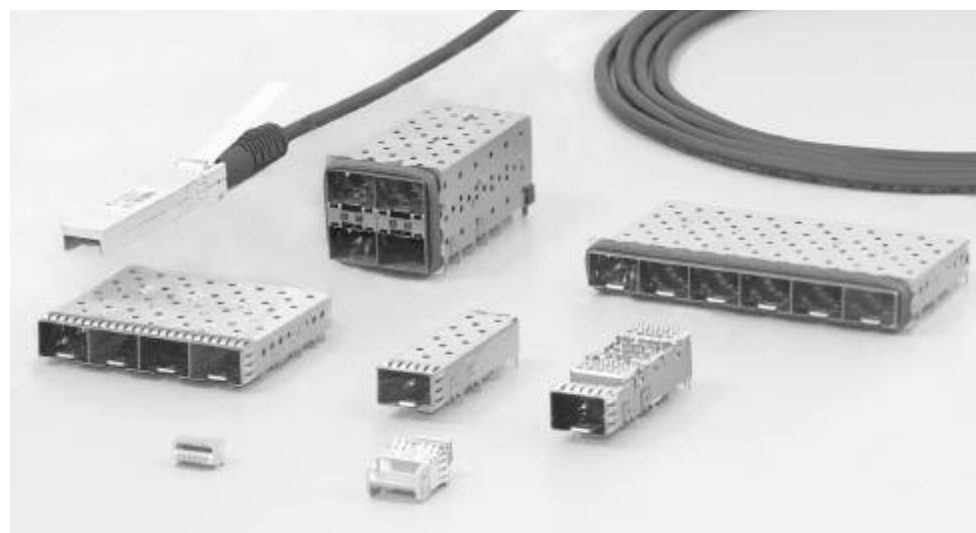

SFP+ extends the use of the Small Form-Factor Pluggable (SFP) interconnect up to 16 Gb/s. This system meets the performance requirements of SFF (Small Form-Factor) specification SFF-8431 and 8G and 16G Fibre Channel and 10G Ethernet applications. The SFP+ product family includes cages, connectors, and copper cable assemblies. SFP+ cages are offered with both EMI springs and elastomeric

conductive gaskets for EMI containment at the panel opening, and come in single port, ganged and stacked port configurations. Connectors are designed to optimize performance at higher data rates. A conductive EMI plug is available to reduce EMI through an empty (unused) SFP+ cage port. TE also offers LC optical connectors and cable assemblies to link with SFP+ transceivers.

Technical Documents

Application Specifications
 114-13120 Single & Ganged Cages
 114-13219 Stacked Cages

Product Specification
 108-2331
 108-2364

Industry Standards

SFF-8432 Cage and module definition
 SFF-8083 Mating Interface and performance requirements
 SFF-8431 Electrical Interface Specifications

SFP+ Single and Ganged Configurations

Cages with EMI Springs



Cage Assemblies

Configuration	Part Number	Tail Type
Single Port	2007198-1	11-Pin Press-Fit
	2007194-1	PCI Solder Tail
	2110304-1	Standard Solder Tail
	2057021-1	Short Solder Tail
	2007215-1	PCI Press-Fit
	2057159-1	20-Pin Press-Fit
1 x 2	2007263-1	
1 x 4	2007132-1	Press-Fit
1 x 6	2007251-1	

Cage Assemblies with heat sink and/or lightpipe options

Configuration	Part Number	Lightpipes	Type of Heat Sink*	Tail Type
Single Port	2007254-1	Standard	N/A	11-Pin Press-Fit
	2007464-1	N/A	PCI	
	2007464-2	N/A	SAN	
	2007464-3	N/A	Networking	PCI Solder Tail PCI Press-Fit
	2007193-1	N/A	PCI	
	2007277-1	N/A	PCI	
1 x 2	2007262-1		N/A	
1 x 4	2007178-1	Standard	N/A	Press-Fit
1 x 6	2007250-1		N/A	

*All assemblies with heat sink include the heat sink clips.

Cages with Elastomeric Gaskets

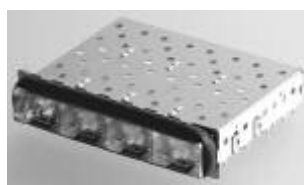

Cage Assemblies

Configuration	Part Number	Tail Type	Belly-to-Belly Applications
Single Port	2057086-2	—	—
1 x 2	2007181-1		No
1 x 4	2007135-1	Press-Fit	No
	2057833-1		Yes
1 x 6	2007170-1		No

Configuration	Part Number	Lightpipes	Tail Type
1 x 2	2007180-1		
1 x 4	2007093-1	Standard	Press-Fit
1 x 6	2007169-1		

Cages for PCI Applications

One degree mounting angle to meet requirements of SFF-8075



Description	Solder	Press-Fit
Cage Assy	2007194-1	2007215-1
Cage Assy w/ PCI Heat Sink & Clip	2007193-1	2007277-1

Connectors



Contact Plating	Part Number
0.76 µm (30 µin) gold	1888247-1
0.38 µm (15 µin) gold	1888247-2

PCI is a trademark of PCI-SIG.

Note: All part numbers are RoHS compliant.

SFP+ Enhanced Single and Ganged Configurations

SFP+

- Original side seam geometry
- Crescent pins on the cage under belly
- Standard EMI pin geometry

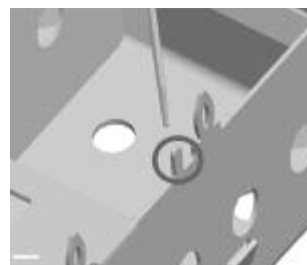

SFP+ EMI Pin Geometry

SFP+ Enhanced

- Improved EMI suppression at the side seam on the cage
- Crescent pins removed, EMI springs added to the under belly for improved EMI performance
- Footprint is compatible with SFP+ pcb footprint
- Improved EMI pin geometry



SFP+ Enhanced EMI Pin Geometry

Cages with EMI Springs



Cage Assemblies

Configuration	Part Number	Cage Design
1 x 2	2180739-1	Heat Sink Slot
1 x 4	2169260-1	Heat Sink Slot
1 x 6	2169259-1	Heat Sink Slot

PT Connector

Part Number	Description
2110759-1	20 Pos, 0.8mm Pitch, 16G

Note: All SFP+ Enhanced cage assemblies come with press-fit tails.

Accessories

Part Number	Description
2169315-2	Heat Sink, Short, Networking
2169315-4	Heat Sink, PCI
2169315-6	Heat Sink, SAN
2169315-8	Heat Sink, Tall, Networking

Part Number	Description
2149266-1	Lightpipe, Standard
2149266-2	Lightpipe, Reduced Length
2149178-1	Heat Sink and Lightpipe Clip
2169851-1	Heat Sink Clip

Configuration	Part Number	Lightpipes	Type of Heat Sink*
1 x 2	2198232-1	Standard	PCI
	2198232-2		SAN
	2198232-3		Networking Short
	2198232-4		Networking Tall
	2198231-1	Reduced Length	PCI
	2198231-2		SAN
	2198231-3		Networking Short
	2198231-4		Networking Tall
	2198230-1	N/A	PCI
	2198230-2		SAN
	2198230-3		Networking Short
	2198230-4		Networking Tall
1 x 4	2198234-1	Standard	PCI
	2198234-2		SAN
	2198234-3		Networking Short
	2198234-4		Networking Tall
	2198233-1	Reduced Length	PCI
	2198233-2		SAN
	2198233-3		Networking Short
	2198233-4		Networking Tall
	2149730-2	N/A	PCI
	2149730-3		SAN
	2149730-4		Networking Short
	2149730-1		Networking Tall
1 x 6	2198237-1	Standard	PCI
	2198237-2		SAN
	2198237-3		Networking Short
	2198237-4		Networking Tall
	2198236-1	Reduced Length	PCI
	2198236-2		SAN
	2198236-3		Networking Short
	2198236-4		Networking Tall
	2198235-1	N/A	PCI
	2198235-2		SAN
	2198235-3		Networking Short
	2198235-4		Networking Tall

Note: All SFP+ Enhanced cage assemblies come with press-fit tails.

*All assemblies with heat sink include the heat sink clips.

Note: All part numbers are RoHS compliant.

SFP+ Enhanced Single and Ganged Configurations (Continued)

Cages with Elastomeric Gasket



Cage Assemblies

Configuration	Part Number	Cage Design	Belly-to-Belly Applications
Single Port	2057086-2	Thermal Vent Holes	No
1 x 2	2057555-1	Thermal Vent Holes	No
	2180900-1	Heat Sink Slot	No
1 x 4	2057353-1	Thermal Vent Holes	No
	2057833-1	Thermal Vent Holes	Yes
	2180463-1	Heat Sink Slot	No
1 x 6	2170148-1	Thermal Vent Holes	No
	2180902-1	Heat Sink Slot	No

Note: All SFP+ Enhanced cage assemblies come with press-fit tails.

Configuration	Part Number	Lightpipes	Type of Heat Sink*
1 x 1	2057085-1	N/A	Blade
	2057085-2	N/A	SAN
	2057085-3	N/A	Networking Nickel
	2057085-4	N/A	Networking Anodized
	2057085-5	N/A	PCI
1 x 2	2057112-1	Standard	N/A
	2057556-1	Standard	N/A
	2198226-1	Standard	PCI
	2198226-2		SAN
	2198226-3		Networking Short
	2198226-4		Networking Tall
	2198225-1	Reduced Length	PCI
	2198225-2		SAN
	2198225-3		Networking Short
	2198225-4		Networking Tall
	2198224-1	N/A	PCI
	2198224-2		SAN
	2198224-3		Networking Short
	2198224-4		Networking Tall
1 x 4	2057161-1	Standard	N/A
	2057458-1	Low Profile	N/A
	2198243-1	Standard	PCI
	2198243-2		SAN
	2198243-3		Networking Short
	2198243-4		Networking Tall
	2198242-1	Reduced Length	PCI
	2198242-2		SAN
	2198242-3		Networking Short
	2198242-4		Networking Tall
	2198241-1	N/A	PCI
	2198241-2		SAN
	2198241-3		Networking Short
	2198241-4		Networking Tall
1 x 6	2110058-1	Standard	N/A
	2198229-1	Standard	PCI
	2198229-2		SAN
	2198229-3		Networking Short
	2198229-4		Networking Tall
	2198228-1	Reduced Length	PCI
	2198228-2		SAN
	2198228-3		Networking Short
	2198228-4		Networking Tall
	2198227-1	N/A	PCI
	2198227-2		SAN
	2198227-3		Networking Short
	2198227-4		Networking Tall

Note: All SFP+ Enhanced cage assemblies come with press-fit tails.

*All assemblies with heat sink include the heat sink clips.

Note: All part numbers are RoHS compliant.

SFP+ Stacked Configurations

Cages with Elastomeric Gasket



Cage Assemblies

Configuration	Part Number	Lightpipes
2 x 1	2007538-5	All 4 Columns
	2007538-6	Inner 2 Only
	2007538-7	Outer 2 Only
	2007538-8	None
2 x 2	2007417-5	All 4 Columns
	2007417-6	Inner 2 Only
	2007417-7	Outer 2 Only
	2007417-8	None
2 x 4	2007399-5	All 4 Columns
	2007399-6	Inner 2 Only
	2007399-7	Outer 2 Only
	2007399-8	None
2 x 5	2169678-5	All 4 Columns
	2169678-6	Inner 2 Only
	2169678-7	Outer 2 Only
	2169678-8	None
2 x 6	2007567-5	All 4 Columns
	2007567-6	Inner 2 Only
	2007567-7	Outer 2 Only
	2007567-8	None
2 x 8	2169788-5	All 4 Columns
	2169788-6	Inner 2 Only
	2169788-7	Outer 2 Only
	2169788-8	None

Note: Tin plated compliant pins listed, tin-lead compliant pins available for signal connector.

Cages with EMI Springs



Cage Assemblies

Configuration	Part Number	Lightpipes
2 x 1	2007492-5	All 4 Columns
	2007492-6	Inner 2 Only
	2007492-7	Outer 2 Only
	2007492-8	None
2 x 2	2007637-5	All 4 Columns
	2007637-6	Inner 2 Only
	2007637-7	Outer 2 Only
	2007637-8	None
2 x 4	2007394-5	All 4 Columns
	2007394-6	Inner 2 Only
	2007394-7	Outer 2 Only
	2007394-8	None
2 x 6	2007562-5	All 4 Columns
	2007562-6	Inner 2 Only
	2007562-7	Outer 2 Only
	2007562-8	None
2 x 8	2149490-5	All 4 Columns
	2149490-6	Inner 2 Only
	2149490-7	Outer 2 Only
	2149490-8	None

Note: Tin plated compliant pins listed, tin-lead compliant pins available for signal connector.

**EMI Plug
Part Number 1888901-1**
Springs comply with SFF-8432 requirements for Improved Pluggable Form-factor (IPF)



Dust Plug (Non-conductive)

For Uses In	Part Number
Single Port Cages	1367147-1 or 1761394-1
Ganged and Stacked (Multi-port) Cages	1761394-1

Note: Dust plug 1761394-1 has narrow width, required for port density in ganged and stacked cages.

Note: All part numbers are RoHS compliant.

SFP+ Copper Cable Assemblies

Product Facts

- Truly broadband — operates from 1 Gbps to 10 Gbps
- Compatible with industry standard SFP cages
- 100 Ohm differential impedance
- 3.3 V input source voltage
- EEPROM signature which can be customized
- Pull-to-release retractable pin latch design
- Pull tab allows compact belly-to-belly application
- 360 degree cable braid crimp and enhanced EMI skirt
- Various wire gauges provide flexible cable management options
- Passive and active cables
- Uses MADISON CABLE brand TURBOTWIN copper cable



The TE SFP+ direct attach copper cable assembly is a low cost alternative for short reach applications. The design allows for a serial data transmission up to 10 Gbps in each direction. These SFP+ assemblies are hot swappable and the programmed EEPROM

signature enables the host to differentiate between a copper cable assembly and a fiber optic module. The mechanical design of the braid crimp and EMI skirt help ensure that EMI radiation is sufficiently suppressed. Additionally, the copper cable acts as a

natural heat sink. The low power consumption assists in making the passive copper cable assembly an economic solution for within rack, or rack to rack applications. SFP+ assemblies are offered in 24 AWG through 30 AWG twinax cable.

Type	Part Number	AWG	Length
Passive	2127934-1	24	0.5m
	2127934-2	24	1 m
	2127934-3	24	2 m
	2127934-4	24	3 m
	2127934-5	24	4 m
	2127934-6	24	5 m
	2127934-7	24	6 m
	2127934-8	24	7 m
	2127933-1	26	0.5 m
	2127933-2	26	1 m
	2127933-3	26	2 m
	2127933-4	26	3 m
	2127933-5	26	4 m
	2127933-6	26	5 m
	2127933-7	26	6 m
	2127932-1	28	0.5 m
	2127932-2	28	1 m
	2127932-3	28	2 m
	2127932-4	28	3 m
	2127932-5	28	4 m
	2127932-6	28	5 m
	2127931-1	30	0.5 m
	2127931-2	30	1 m
	2127931-3	30	2 m
	2127931-4	30	3 m

Type	Part Number	AWG	Length
Active	2032757-1	30	0.5m
	2032757-2	30	1 m
	2032757-3	30	2 m
	2032757-4	30	3 m
	2032757-5	30	4 m
	2032757-6	30	5 m
	2032757-7	30	6 m
	2032757-8	30	7 m
	2032757-9	28	8 m
	1-2032757-0	28	9 m
	1-2032757-1	24	10 m
	1-2032757-2	24	11 m
	1-2032757-3	24	12 m
	1-2032757-4	24	13 m
	1-2032757-5	24	14 m
	1-2032757-6	24	15 m

Note: All part numbers are RoHS compliant.

SFP+ Copper Cable Assemblies (Continued)

High Speed Electrical Measurements

TE SFP+ passive copper cable assemblies are fully compliant to SFF-8431.

WDP Measurements

WDP measurements listed in the table below are for set lengths at two different cable gauges. Any cable with the same gauge and a shorter length than the length listed will have a lower dWDP number. Measurements were taken with an input signal that had pre-emphasis applied to achieve a WDPi of 2.4 dBe while using the SFP+ Module Compliance Board (MCB) and Host Compliance Board (HCB). A copper cable assembly will be compliant with the SFP+ MSA Rev 3.2 if the dWDP number is less than 6.75 dBe.

WDP Specifications

Cable Gauge	Cable Length	WDPo (dB)	WDPi (dB)	dWDP
Spec Limit	—	—	—	6.75
30 AWG	3 meter	6.16	2.4	3.76
28 AWG	5 meter	7.49	2.4	5.09
26 AWG	6 meter	8.36	2.4	5.96
24 AWG	7 meter	7.44	2.4	5.04

VMA and VCR Measurements

VMA and VCR measurements listed in the table below are for the set lengths. To be compliant with SFF 8431 Rev 3.2 the VMA measurements must be less than 4.5 dB while testing with the module compliance test board. The VCR measurement is determined by computing VMA and NEXT RMS voltage measurements. The VCR measurement must be greater than 33 dB to be SFF-8431 Rev 3.2 compliant.

VMA and VCR Specifications

Cable Gauge	Cable Length	VMA (dB)	VCR (dB)
Spec Limit	—	4.5	33
30 AWG	3 meter	3.03875	40.6572
28 AWG	5 meter	3.93609	38.53281
26 AWG	6 meter	3.94267	35.82669
24 AWG	7 meter	2.86154	37.79826

For additional SFP+ cable assembly technical information, see customer drawing 2032237.

SFP Single Port Cages and Connectors

Product Facts

- Full metal shield for grounding and EMI suppression
- Solder and Press Fit cage configurations available
- Single piece and two piece cages available
- Used in conjunction with 20 pin SMT SFP Connector
- Hot Swappable
- Compatible with SFP MSA Compliant Modules
- UL/CSA Report File E28476

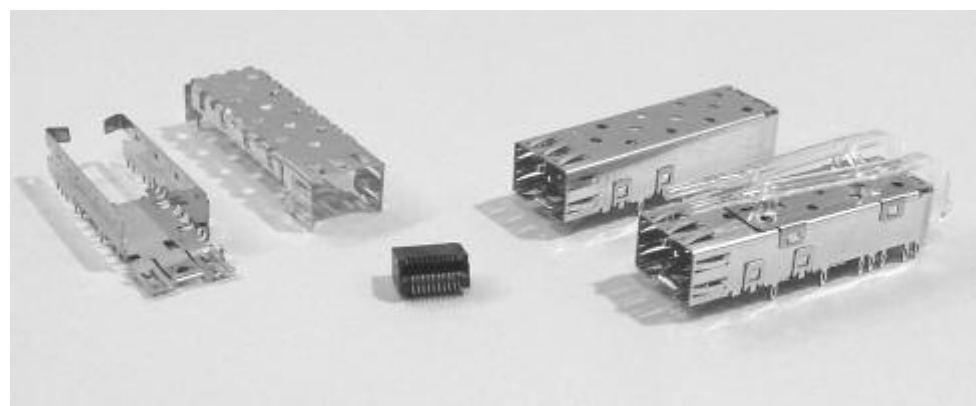

TE offers various termination options for SFP cages, including press-fit, wave solder and IR reflow compatible with tape and reel packaging. The connector is a reliable 20 position

interface offered in 0.38 μm (15 μinch) and 0.76 μm (30 μinch) gold plating thicknesses. The connector is packaged in tape and reel for pick and place SMT application.

The cage material is a copper alloy with nickel sub-plate and a matte tin finish.

Cages

Part Number	Description	Belly-to-Belly Applications
6367034-1	SFP Cage Bottom (Reflow Solder)	Yes
6367035-1	SFP Cage Top	
1489669-1	Press Fit, 8 Pins	Yes
1489779-1	Press Fit, 20 Pins	No
1489962-1	Relow or Wave Solder, 3.55 mm Tail	No
1489962-3	Relow or Wave Solder, 1.8 mm Tail	No
1367629-1	Press Fit w/ Lightpipes	No
1932002-1	Reflow or Wave Solder, 1.10 mm Tail	No

Technical Documents

Instruction Sheet

408-8495 SFP Connector and Cage Assembly

Application Specification

114-13017 SFP Connector and 2-piece Cage Assembly
 114-13120 SFP Connector and Press Fit Cage Assy

Product Specifications

108-1949 SFP Connector
 108-1950 SFP Cage

SFP Standard

SFF Document INF-8074

Connectors and Dust Plugs

Part Number	Description
1367073-1	20 pin, surface mount connector; 0.38 μm (15 μin) gold plating
1367073-2	20 pin, surface mount connector; 0.76 μm (30 μin) gold plating
1658197-1	20 pin, surface mount connector; 0.76 μm (30 μin) gold plating with contact surface treatment
1888247-1	20 pin, surface mount connector; 0.76 μm (30 μin) higher speed SFP+ compliant
1888247-2	20 pin, surface mount connector; 0.38 μm (15 μin) higher speed SFP+ compliant
1367147-1	SFP Dust Plug with AMP product logo
1367147-3	SFP Dust Plug without AMP product logo

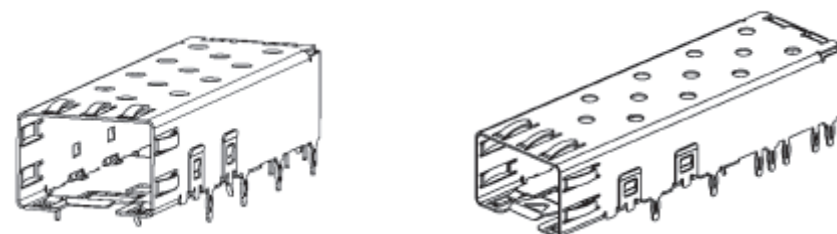

Note: All part numbers are RoHS compliant.

SFP Single Port Cages and Connectors (Continued)

SFP Cage Top
Part Number 6367035-1

Cage top attached after bottom is soldered

SFP Cage Bottom
Part Number 6367034-1

Cage bottom supplied in tape and reel packaging for SMT processing

2 Piece Cage System

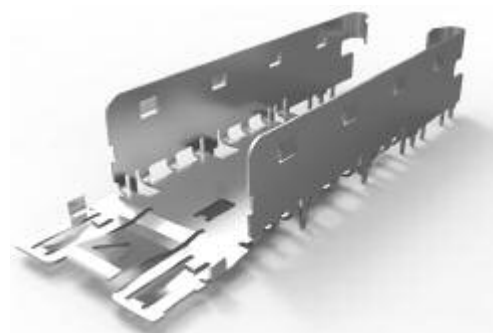

SFP Press Fit Cage Assembly
Part Number 1489669-1



SFP Press Fit Cage with Lightpipe Assembly
Part Number 1367629-1



Connector
Part Number 1367073-1



Dust Plug
Part Number 1367147-1



Note: All part numbers are RoHS compliant.

SFP Ganged (Single Row) Cages

Product Facts

- Full metal shield for grounding and EMI reduction
- Solder and Press Fit configurations available
- Used in conjunction with 20 pin SMT SFP Connector
- Hot Swappable
- Compatible with SFP MSA Compliant Modules
- UL/CSA Report File E28476
- Application tooling available for press fit SFP cages

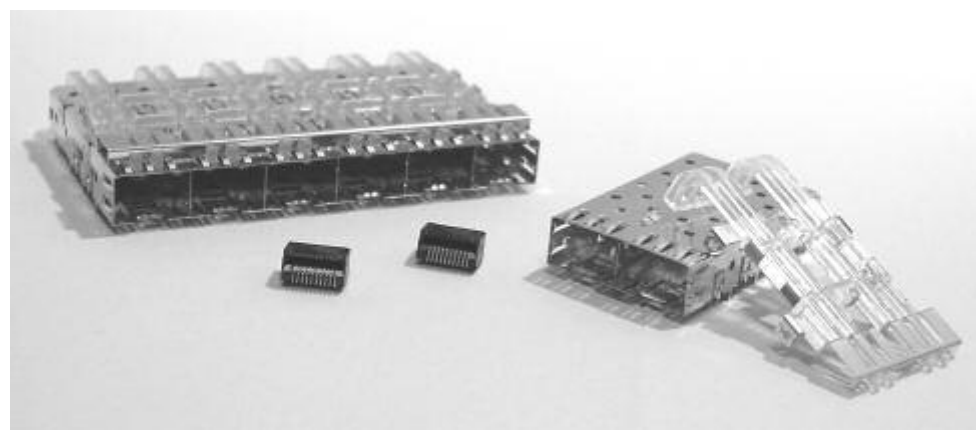

The Ganged SFP product line allows for single row, high density port designs to maximize the horizontal I/O space. The design allows for belly-to-belly orientation to maximize port density. The lateral port-to-port spacing is minimized to 14.25mm, compared to

16.25mm required spacing between single port cages. Port configurations include 1x2, 1x4 and 1x6, with lightpipes optional.

Application tooling is required for press fit configurations to provide support during insertion into the board.

Technical Documents

Instruction Sheet

- 408-8848 SFP Cage Assembly Seating Tool
- 408-8849 SFP Cage Assembly Extraction Tool

Application Specification

- 114-13017 SFP Connector and 2-piece Cage Assembly
- 114-13120 SFP Connector and Press Fit Cage Assy

Product Specifications

- 108-1949 SFP Connector
- 108-1950 SFP Cage

Part Number	Port Configuration	PCB Attachment	Belly-to-Belly Application	Lightpipes Included
1761014-1	1x2	Press Fit	Yes	No
1761007-1	1x2	Press Fit	No	Yes
1658744-1	1x4	Press Fit	Yes	No
1658723-1	1x4	Solder Tail	Yes	No
1761008-1	1x4	Press Fit	No	Yes
2143438-1	Angled 1x4	Press Fit	No	Yes
2149060-1	Angled 1x4	Press Fit	No	No
1761015-1	1x6	Press Fit	Yes	No
1658939-1	1x6	Press Fit	No	Yes
2110957-1	1x6	Press Fit (Rear Compliant Pins)	No	No
2007498-1	1x6	Press Fit	No	No

Lightpipe Assembly

Part Number	Port Configuration	PCB Attachment
1761011-1	1x2	Press Fit
1761012-1	1x4	Press Fit
1761013-1	1x6	Press Fit



Connectors and Dust Plugs

Part Number	Description
1367073-1	20 pin, surface mount connector; 0.38 µm (15 µin) gold plating
1367073-2	20 pin, surface mount connector; 0.76 µm (30 µin) gold plating
1658197-1	20 pin, surface mount connector; 0.76 µm (30 µin) gold plating with contact surface treatment
1888247-1	20 pin, surface mount connector; 0.76 µm (30 µin) higher speed SFP+ compliant
1888247-2	20 pin, surface mount connector; 0.38 µm (15 µin) higher speed SFP+ compliant
1761394-1	SFP Dust Plug

Note: All part numbers are RoHS compliant.

SFP Stacked (Dual Row) Cage/Connector Assemblies

Product Facts

- Utilizes integrated stacked connector with patented wafer construction
- Full metal shield for grounding and EMI reduction
- Incorporates press fit eye-of-the-needle contacts for both mechanical cages and electrical connector
- Hot Swappable
- Compatible with SFP MSA Compliant Modules
- Application tooling available
- UL/CSA Report File E28476  

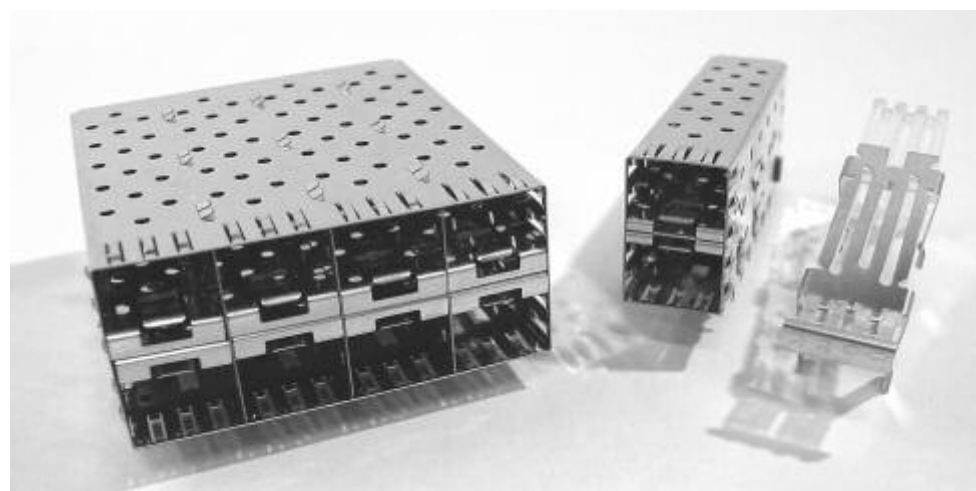

The Stacked SFP product maximizes port density by taking advantage of the reduced port spacing of the ganged SFP cages, with an added upper port row. The connector is integrated into the cage assembly,

using press-fit technology for one-step insertion for cage and connector. Two heights are offered for stacked SFP cages, and available in 2x1, 2x4, and 2x6 port configurations.

Technical Documents

Instruction Sheet

- 408-8848 SFP Cage Assembly Seating Tool
- 408-8849 SFP Cage Assembly Extraction Tool
- 408-8850 Stacked SFP Connector Extraction Tool

Application Specification

- 114-13103 Stacked SFP Connector & Cage Assembly

Product Specifications

- 108-2161 SFP Connector & Cage Assemblies

SFP Stacked (Dual Row) Cage/Connector Assemblies (Continued)

Standard Profile 2x4 Configuration
Part Number 1658390-1

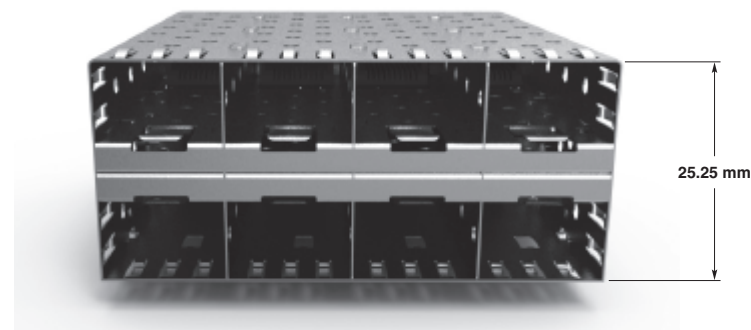

Low Profile 2x4 Configuration
Part Number 1658629-1



Part Number	Port Configuration	Height Profile	Lightpipes Included
1658391-1	2x1	Standard	No
1658628-1	2x1	Low Profile	No
1658859-1	2x1	Low Profile	Yes
1658390-1	2x4	Standard	No
1658629-1	2x4	Low Profile	No
1658758-1	2x4	Low Profile	Yes
1761327-1	2x6	Standard	No
1658894-1	2x6	Low Profile	No
1658895-1	2x6	Low Profile	Yes

Note: TE lightpipe assemblies are packaged with the SFP cage assembly. The lightpipes attach to the top of the SFP cage for clear visibility in a high density application.



Related Products

Part Number	Description
1761394-1	SFP Dust Plug

Note: All part numbers are RoHS compliant.

SFP Cages with Integrated Connectors

Product Facts

- Utilizes fully integrated 20 position SFP connector
- Full metal shield for grounding and EMI reduction
- Incorporates press fit eye-of-the-needle contacts for both mechanical cages and electrical connector
- Hot Swappable
- Compatible with SFP MSA Compliant Modules
- Application tooling available
- UL/CSA Report File E28476  

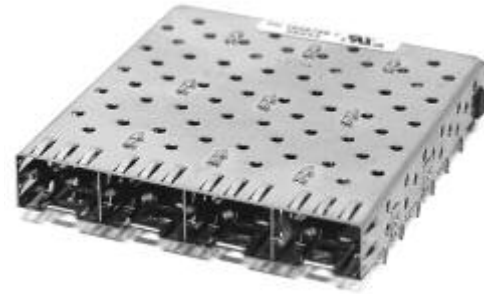
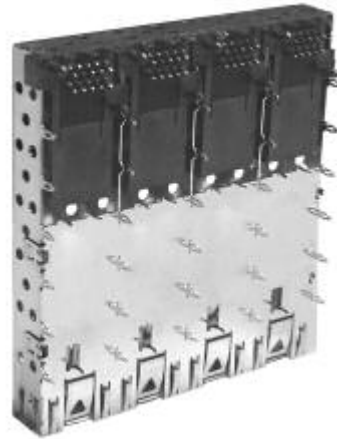

For increased flexibility, TE offers ganged (single Row) SFP cages with integrated connectors that are footprint compatible with its Stacked

SFP product line. The connector uses the same press fit technology as incorporated in the stacked SFP cage/connector sys-

tem, with one-step insertion in the board. Products currently offered are 1x1 and 1x4 configurations.

Part Number 1932068-1



Part Number 1932069-1



Technical Documents

Instruction Sheet

- 408-8848 SFP Cage Assembly Seating Tool
- 408-8849 SFP Cage Assembly Extraction Tool
- 408-8850 Stacked SFP Connector Extraction Tool

Application Specification

- 114-13121 SFP Ganged Press Fit Connector & Cage Assembly

Product Specifications

- 108-2161 SFP Connector & Cage Assembly

Part Number	Port Configuration	Footprint Compatible with Stacked SFP	Press Fit Exemption Tin Lead on I/O Contacts
1932068-1	1x1	1658391-1 1658628-1	Yes
1932069-1	1x4	1658390-1 1658629-1	Yes

Related Products

Part Number	Description
1761394-1	SFP Dust Plug

Note: All part numbers are RoHS compliant.

SFP Cages with Riding Heat Sinks

Product Facts

- Designed for DWDM Switch applications
- High Density application requiring additional Thermal Management
- Riding heat sink technology addresses thermal management
- Full metal shield for grounding and EMI reduction
- Incorporates press fit eye-of-the-needle contacts for mechanical cages
- Compatible with DWDM MSA compliant transceivers
- Uses 20 pin SMT SFP Connector



TE introduced an SFP system incorporating a riding heat sink to help manage excess heat when using SFP modules. This is especially suited for use with higher wattage transceivers, such as long reach applications like Dense Wavelength Division Multiplexing (DWDM).

The system features a press fit cage, a heat sink clip, and heat sink with various pin heights available.

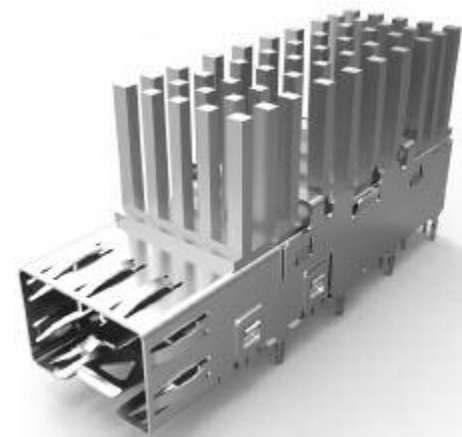

Cages, Heat Sinks, and Clips

Part Number	Product Description
1367643-1	1x1 SFP Cage for heat sink application
1367646-1	Heat Sink Clip
1829903-2	PCI Heat Sink (4.2mm)
1829904-2	SAN Heat Sink (6.5mm)
1829905-2	Networking Heat Sink (13.5mm)
1367645-1	Kit: Cage, Clip and PCI Heat Sink (4.2mm)
1367645-2	Kit: Cage, Clip and SAN Heat Sink (6.5mm)
1367645-3	Kit: Cage, Clip and Networking Heat Sink (13.5mm)

Connectors and Dust Plugs

Part Number	Description
1367073-1	20 pin, surface mount connector; 0.38 μm (15 μin) gold plating
1367073-2	20 pin, surface mount connector; 0.76 μm (30 μin) gold plating
1658197-1	20 pin, surface mount connector; 0.76 μm (30 μin) gold plating with contact surface treatment
1888247-1	20 pin, surface mount connector; 0.76 μm (30 μin) higher speed SFP+ compliant
1888247-2	20 pin, surface mount connector; 0.38 μm (15 μin) higher speed SFP+ compliant
1367147-1	SFP Dust Plug with AMP product logo
1367147-3	SFP Dust Plug without AMP product logo

Product Facts

- SFP angled cages provide better cable routing than the standard SFP cages



SFP Angled Assemblies

Part Number	Port Configuration	Description
2143438-1	1x4	30 Degree with Lightpipes

PCI is a trademark of PCI-SIG.

Note: All part numbers are RoHS compliant.

SFP Copper Cable Assemblies

Product Facts

- SFF 20 position PCB interface
- Cable wire size 28 AWG
- Robust pull to release latch mechanism
- Various standard cable assembly lengths
- Compatible with MSA compliant SFP cages
- Uses MADISON CABLE brand TURBOTWIN copper cable



Applications

- Switches, routers and host bus adapters (HBA's)
- Enterprise storage
- High density I/O's
- Multiple channel interconnects

The TE SFP copper cable assemblies are high speed, high performance solutions for 4.25 Gbps applications. The TE SFP copper assemblies provide a cost effective solution over

Fiber for short reach I/O applications. These assemblies support multiple data transfer protocols such as Fibre Channel, InfiniBand Standard and Gigabit Ethernet.

SFP Direct Attach Cable Assembly Part Numbers

Description	Part Number	Length	Equalization
4.25 Gbps Passive	1948134-1	0.5 m	Unequalized
	1948134-2	1 m	Unequalized
	1948134-3	2 m	Equalized
	1948134-4	3 m	Equalized
	1948134-5	4 m	Equalized

Fibre Channel is a trademark of the Fibre Channel Industry Association.
 INFIBAND is a trademark of the InfiniBand Trade Association.

Note: All part numbers are RoHS compliant.

LC Connector Kits

LC Connector Kits — Standard Kits

Product Facts

- Singlemode Telcordia GR-326 Tested (Report 501-652)
- Multimode TIA/EIA 568B.3 tested
- Components packaged in 25 piece bags for easy access
- Same one-piece connector body for jumper and buffer
- Field installable duplex clip
- Compatible with anaerobic adhesives
- Mates with LC adapters, LC Transceivers

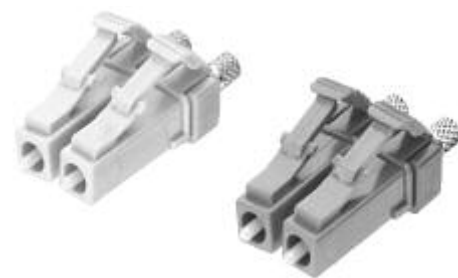

Performance (typical)

Insertion Loss — 0.2dB

Reflectance — -55dB

Operating Temperature —

-40° C to +75° C

Material

Ferrule — Zirconia

Housing — UL 94 V-0 rated thermoplastic

Length —

Ferrule Tip to End of Boot

900 μ m Buffered — 31.5 mm

2.0 mm Jacketed — 52.0 mm

3.0 mm Jacketed — 51.0 mm

Description	Fiber Type	Housing Color	Boot Color	Used with	Assembly Pack Part Number
Simplex	Singlemode	Blue	Blue	900 μ m Buffered	2064937-1
				1.6-2.0 mm Jacketed	2064937-2
				3.0 mm Jacketed	2064937-3
	Multimode	Beige	Beige	900 μ m Buffered	2064938-1
				1.6-2.0 mm Jacketed	2064938-2
				3.0 mm Jacketed	2064938-3
Duplex	Singlemode	Blue	Blue	900 μ m Buffered	2-2064937-1
				1.6-2.0 mm Jacketed	2-2064937-2
				3.0 mm Jacketed	2-2064937-3
	Multimode	Beige	Beige	900 μ m Buffered	2-2064938-1
				1.6-2.0 mm Jacketed	2-2064938-2
				3.0 mm Jacketed	2-2064938-3

LC Connector Kits — Short Boot Kits

Product Facts

- Ferrule Tip to End of Boot Length: 42.5 mm
- 27.45 mm adapter to end of boot
- GR-326 small form factor requirements

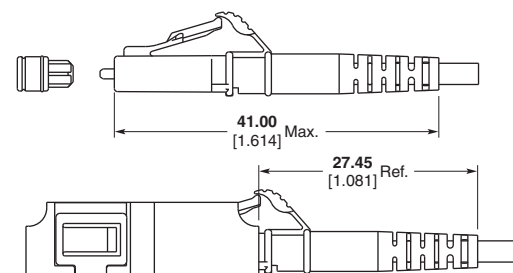

Description	Fiber Type	Housing Color	Boot Color	Used with	Installation Pack Part Number
Simplex	Singlemode	Blue	Blue	1.6-2.0 mm Jacketed	1918407-1
	Multimode	Beige	Beige	1.6-2.0 mm Jacketed	1918405-1
Duplex	Singlemode	Blue	Blue	1.6-2.0 mm Jacketed	1918406-1
	Multimode	Beige	Beige	1.6-2.0 mm Jacketed	1918404-1

Note: All part numbers are RoHS compliant.

LC Connector Components

**LC Components —
1.6-2.4 mm Jacketed Cable
(Order One of Each
Component Excluding Clip for Simplex, Two of Each
Plus One Clip for Duplex)**

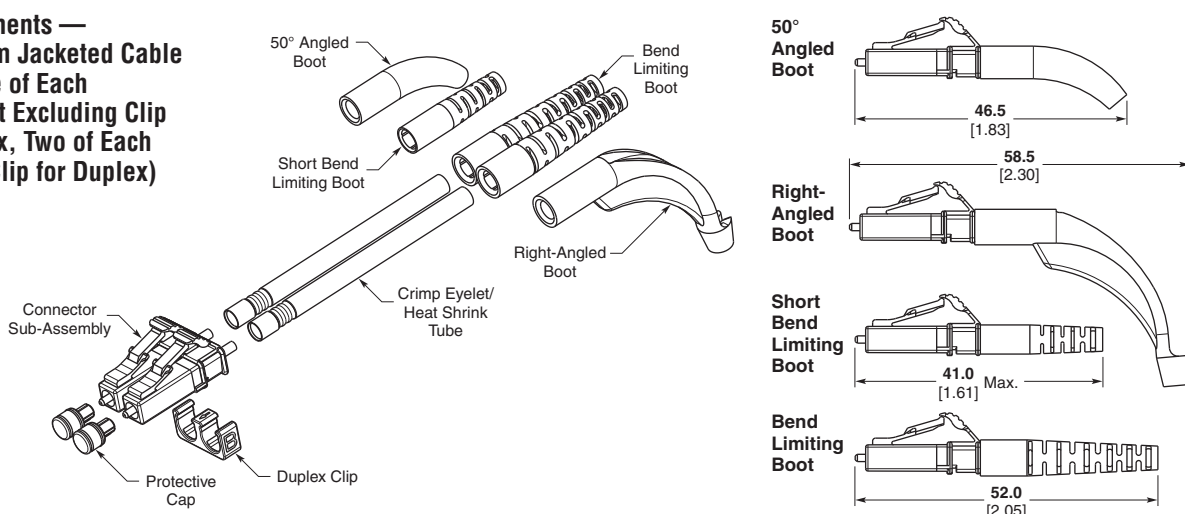

Fiber Type	Simplex Connector Sub-Assembly & Protective Cap	Duplex Clip	Cable Size	Crimp Eyelet with Heat Shrink Tube	Boot Description	Boot Part Number			
Singlemode (Blue Hsg.)	1828456-1	1754371-4	1.6-2.0 mm	1918918-2	Short Bend Limiting	1918403-x			
					Bend Limiting	1588153-x			
			1.6-2.0 mm	6374150-2	Right-Angled	1374737-x			
					50 Degree Angled	6457543-x			
			2.4 mm	6588189-1	Bend Limiting	1588153-x			
					Right-Angled	1374737-x			
Multimode (Beige Hsg.)	1754625-1	1754371-5	1.6-2.0 mm	1918918-1	Short Bend Limiting	1918403-x			
					Bend Limiting	1588153-x			
			1.6-2.0 mm	6374150-1	Right-Angled	1374737-x			
					50 Degree Angled	6457543-x			
			2.4 mm	6588189-1	Bend Limiting	1588153-x			
					Right-Angled	1374737-x			
								50 Degree Angled	6457543-x

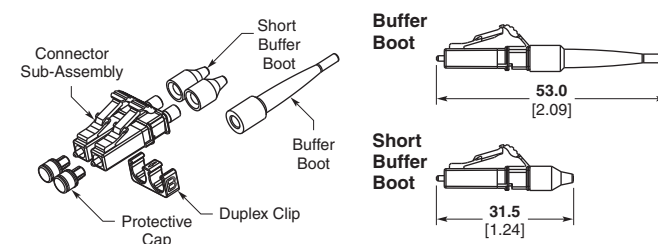

**LC Components — 900 µm Buffered Fiber
(Order One of Each Component Excluding Clip for Simplex,
Two of Each Plus One Clip for Duplex)**

Fiber Type	Simplex Connector Sub-Assembly & Protective Cap	Duplex Clip	Boot Description	Boot Part Number
Singlemode (Blue Hsg.)	1828456-1	1754371-4	Buffer	1828184-x
			Short Buffer	6588612-x
Multimode (Beige Hsg.)	1754625-1	1754371-5	Buffer	1828184-x
			Short Buffer	6588612-x

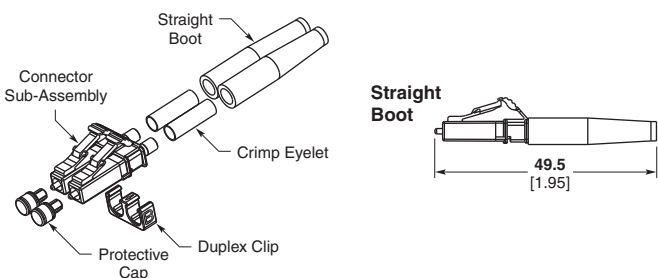

**LC Components — 3.0 mm Jacketed Cable
(Order One of Each Component Excluding Clip for Simplex,
Two of Each Plus One Clip for Duplex)**

Fiber Type	Simplex Connector Sub-Assembly & Protective Cap	Duplex Clip	Crimp Eyelet	Boot Part Number
Singlemode (Blue Hsg.)	1828456-1	1754371-4	5504118-3	502716-x
Multimode (Beige Hsg.)	1754625-1	1754371-5	5504118-3	502716-x

Instruction Sheet: 408-8675

Note: All part numbers are RoHS compliant.

10 Gigabit Fiber Optic Products Overview

MTP/MPO Round Cable Assemblies



QSFP Compatible MPO to MPO

Fiber Type	Fiber Count	Length in meters	Part Number
10 Gig / OM3 (50/125)	8	1	1938323-1
		5	1938323-5
		10	1-1938323-0
		20	2-1938323-0
		50	5-1938323-0

12-Fiber Reversed Fiber Path MPO to MPO

Fiber Type	Fiber Count	Length in meters	Part Number
10 Gig / OM3 (50/125)	12	1	1938324-1
		5	1938324-5
		10	1-1938324-0
		20	2-1938324-0
		50	5-1938324-0

For custom configurations, contact your TE sales representative.

LC Cable Assemblies



Simplex / Duplex	Cable Type	Side A	Side B	Jacket Type	Part Number	Part Numbers/Lengths (m)					
						1	2	3	5	10	15
LC Cable Assemblies											
Duplex	50/125 OM3	LC	LC	2 mm jacketed riser	X-2064862-X	2064862-1	2064862-2	2064862-3	2064862-5	1-2064862-0	1-2064862-5
	10Gig Fiber	LC	SC	2 mm jacketed riser	X-2064863-X	2064863-1	2064863-2	2064863-3	2064863-5	1-2064863-0	1-2064863-5
SC Cable Assemblies											
Simplex	50/125 OM3 10Gig Fiber	SC	SC	2 mm jacketed riser	X-2064883-X	2064883-1	2064883-2	2064883-3	2064883-5	1-2064883-0	1-2064883-5
Duplex	50/125 OM3 10Gig Fiber	SC	SC	2 mm jacketed riser	X-2064886-X	2064886-1	2064886-2	2064886-3	2064886-5	1-2064886-0	1-2064886-5
	50/125 OM3 10Gig Fiber	SC	ST	2 mm jacketed riser	X-2064889-X	2064889-1	2064889-2	2064889-3	2064889-5	1-2064889-0	1-2064889-5
ST Cable Assemblies											
Simplex	50/125 OM3 10Gig Fiber	ST	ST	2 mm jacketed riser	X-2064877-X	2064877-1	2064877-2	2064877-3	2064877-5	1-2064877-0	1-2064877-5
Duplex	50/125 OM3 10Gig Fiber	ST	ST	2 mm jacketed riser	X-2064880-X	2064880-1	2064880-2	2064880-3	2064880-5	1-2064880-0	1-2064880-5
MT-RJ SECURE Cable Assemblies											
Duplex	50/125 OM3 10Gig Fiber	MT-RJ	MT-RJ	1.8 mm jacketed riser	X-6588572-X	6588572-1	6588572-2	6588572-3	6588572-5	1-6588572-0	1-6588572-5
	50/125 OM3 10Gig Fiber	MT-RJ	SC	1.8 mm jacketed riser	X-6588573-X	6588573-1	6588573-2	6588573-3	6588573-5	1-6588573-0	1-6588573-5

Additional lengths available. See TE specification 1206850 for more details

Note: All part numbers are RoHS compliant.

QSFP (Quad Small Form-factor Pluggable) Products

Applications

- Switches
- Routers
- Host bus adapters
- Enterprise storage
- High performance computing

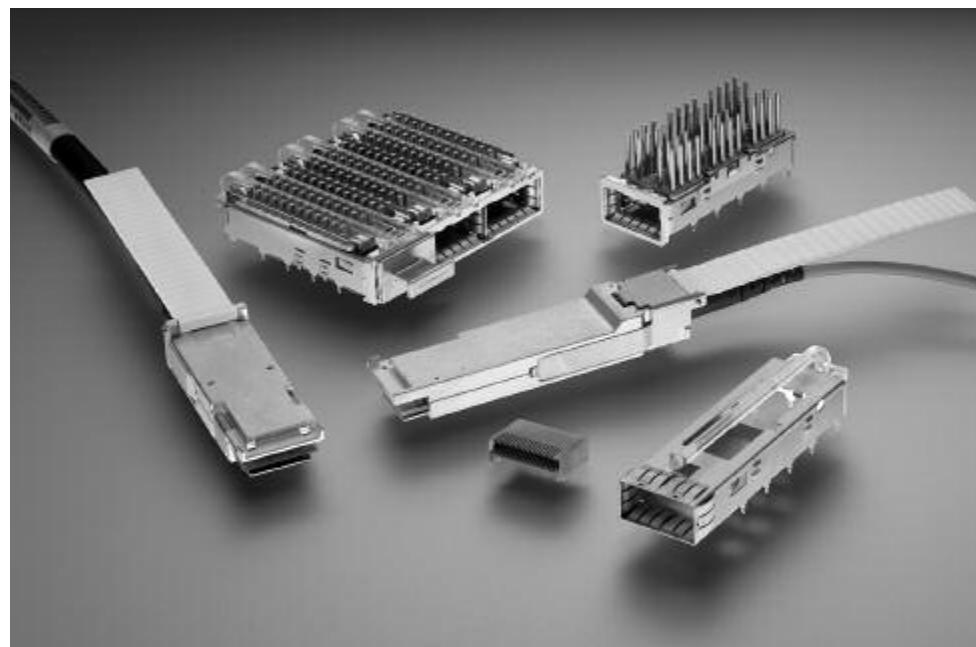

The Quad Small Form-factor Pluggable (QSFP) product line from TE Connectivity (TE) is a four-channel package, offering 3 times the density of traditional SFP ports and now supports speeds up to more than 25Gb/s per channel to support the new 100 Gbps Ethernet and 100 Gbps

InfiniBand Enhanced Data Rate applications. The QSFP product lines include zQSFP, and QSFP/QSFP+ products that feature cages, connectors, and copper and optical cable assemblies developed within the QSFP MSA (Multi-Source Agreement).

zQSFP+ Products

Product Facts

- Backward compatible to QSFP+ optical modules and cable assemblies
- Enhanced EMI cage for excellent thermal performance and EMI protection
- New contact geometry and design of the connector provide superior signal integrity
- Staggered press-fit pins to accommodate belly-to-belly applications and enable the use of both sides of a PCB for space savings



Applications

- Storage
- Servers
- Networking
- Switches
- Routers
- Cellular Infrastructure
- Medical Equipment

Technical Documents

Application Specification

114-32023 and 114-32022

Product Specification

108-19428

The zQSFP+ (z-Quad Small Form-factor Pluggable Plus) connector and cage assembly is a high-density, high-speed product solution designed for applications in the telecommunications, data center and networking markets. The interconnect offers four channels of high-speed differential signals with data rates ranging from 25 Gbps up to potentially 40 Gbps, and will meet 100 Gbps Ethernet

(4x25 Gbps) and 100 Gbps 4X InfiniBand Enhanced Data Rate (EDR) requirements.

To make system upgrades simple and effortless, the zQSFP+ interconnect is backwards-compatible with existing, broadly-established QSFP+ optical modules and cable assemblies. Designed with an enhanced electromagnetic interference (EMI) cage, the product helps to provide excellent

thermal performance and EMI protection. Through a coupled, narrow-edged, blanked- and formed-contact geometry and insert molding design, the zQSFP+ interconnect exhibits superior signal integrity, mechanical and electrical performance. It can be used in current 10-Gbps and 16-Gbps applications with substantial margin.

zQSFP+ Products (Continued)

Single Port SMT

- Designed for high-density interconnect applications
- Support new 100 Gbps Ethernet and 100 Gbps InfiniBand Enhanced Data Rate (EDR) applications
- Offer 4 lanes of high-speed differential signals with data rates of 25+ Gbps
- Share the same mating interface as the QSFP+ form factor
- zQSFP+ EMI cages are designed with an advanced heat sink system to provide a high level of heat dissipation for next-generation system-power levels
- The spring-finger design provides optimal EMI grounding and allows for more space to route high-speed traces
- A conductive EMI plug is available to reduce EMI leakage through an empty (unused) cage port

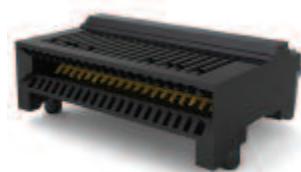

zQSFP+ Connector

Part Number	Description
1551920-2	38 pos SMT Board conn, 25 Gb/s



zQSFP+ Cage Assembly

Part Number	Description
1551892-1	1x1, Behind Bezel, w/PCI Heat Sink
1551892-2	1x1, Behind Bezel, w/SAN Heat Sink
1551892-3	1x1, Behind Bezel, w/Networking Heat Sink
2173239-1	1x3, Behind Bezel, w/PCI Heat Sink
2173239-2	1x3, Behind Bezel, w/SAN Heat Sink
2173239-3	1x3, Behind Bezel, w/Networking Heat Sink

Dual Port Press-fit

- High-port-density 25Gbps data rate connector offers complete integration of the connector within a cage
- Includes optional lightpipes to provide port-status indication to the user
- Two rows of belly-to-belly vertically stacked zQSFP+ 2x1 configuration offered
- Elastomeric gasket provides excellent Electro Magnetic Interference (EMI) protection
- Product accepts QSFP/QSFP+ compliant modules, allowing installers to configure and upgrade high-speed Ethernet and Fibre Channel (FC) ports
- A conductive EMI plug is available to reduce EMI leakage through an empty (unused) cage port



zQSFP+ Connector and Cage Assembly

Part Number	Configuration	Lightpipes	Left Indicator
2198373-1	2x1	No	—
2198373-2	2x1	Yes	Up
2198373-3	2x1	Yes	Down

Note: All part numbers are RoHS compliant.

Fibre Channel is a trademark of the Fibre Channel Industry Association.
 INFIBIBAND is a trademark of the InfiniBand Trade Association.

QSFP+ Copper Cable Assemblies

Product Facts

- QDR (10Gbps/lane) data rates
- Compatible with industry standard QSFP cages
- EEPROM signature which can be customized
- Pull tab unlatching allows compact belly to belly application
- 360 degree cable braid crimp suppresses EMI
- Uses MADISON CABLE brand TURBOTWIN copper cable

Applications

- Switches, routers and host bus adapters (HBA's)
- Enterprise storage
- High density I/O's
- Multiple channel interconnects



TE is a developer of Quad Small Form Factor Pluggable (QSFP+) high speed, high performance cable assemblies. The QSFP+ assembly offers 4 channels of data, providing 3 times the

density of SFP/SFP+ ports. QSFP+ cable assemblies can support data rates up to 10Gbps per differential pair, and support Fibre Channel, Ethernet and InfiniBand standards.

Part Number	Description	AWG	Length
2053638-1	QSFP+ to QSFP+ Passive	30	1m
2053638-2	QSFP+ to QSFP+ Passive	30	2m
2053638-3	QSFP+ to QSFP+ Passive	30	3m
2053638-4	QSFP+ to QSFP+ Passive	28	4m
2053638-5	QSFP+ to QSFP+ Passive	26	5m
1-2053638-6	QSFP+ to QSFP+ Passive	30	0.5m
2053453-1	QSFP+ to [4] SFP+ Passive	30	0.5m
2053453-2	QSFP+ to [4] SFP+ Passive	30	1m
2053453-3	QSFP+ to [4] SFP+ Passive	30	2m
2053453-4	QSFP+ to [4] SFP+ Passive	30	3m
2053453-5	QSFP+ to [4] SFP+ Passive	28	4m
2053453-6	QSFP+ to [4] SFP+ Passive	26	5m

Fibre Channel is a trademark of the Fibre Channel Industry Association.

INFINIBAND is a trademark of the InfiniBand Trade Association.

Note: All part numbers are RoHS compliant.

QSFP/QSFP+ Products

Product Facts

- 4x solution featuring TE 38 position EVERCLEAR connector
- Lightpipe and heat sink options available
- Through-bezel and behind-bezel cage options with proven EMI containment
- Direct attach copper cables for short reach applications
- Quick release latching system
- MPO connectors plug into QSFP parallel optic transceiver modules

Applications

- Switches, routers, and host bus adapters (HBA's)
- Enterprise storage
- High density, high speed I/O
- Multiple channel interconnects

Technical Documents

Product Specification

108-2286

Industry Standard

SFF-8436



QSFP cages and connectors are designed for data rates up to 10 Gb/s per channel, supporting Fibre Channel, Ethernet, SDH/SONET, and InfiniBand standards. The cage/connector system will accept optical or copper interfaces.

The QSFP product line includes cages in single and ganged configurations with various heat sink and lightpipe options. The connector is a 38 position high speed SMT connector and EMI plugs are offered for empty ports. Cabling options include direct attach copper

cable assemblies, active optical assemblies and MPO optical cable assemblies that plug into a QSFP transceiver module.

Fibre Channel is a trademark of the Fibre Channel Industry Association.

INFINIBAND is a trademark of the InfiniBand Trade Association.

QSFP Cages and Connectors

Cages

- Reliable springs and gasket designs for EMI containment
- Single and dual lightpipe options
- Riding heat sinks for thermal dissipation, various pin heights available
- Belly-to-belly compatible (double-sided PCB's)
- Press-fit termination
- Port-to port spacing — 21.0 mm (through-bezel)/ 23.5 mm (behind-bezel)
- Behind bezel design eliminates potential for mismatching plug
- Rugged stops to prevent over insertion of module

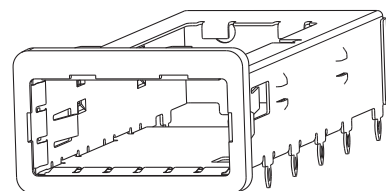

Behind-Bezel Cage

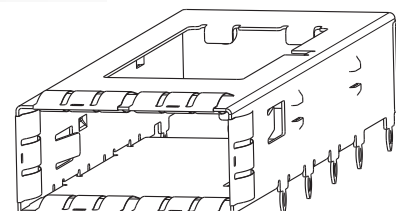

Through-Bezel Cage

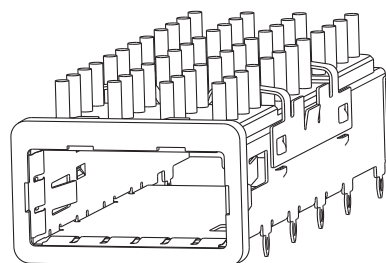

Behind-Bezel Cage with Heat Sink

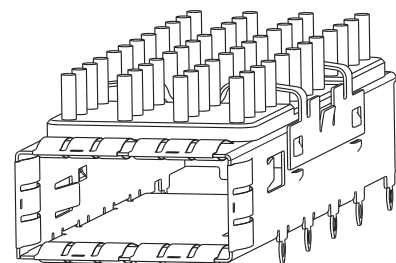

Through-Bezel Cage with Heat Sink

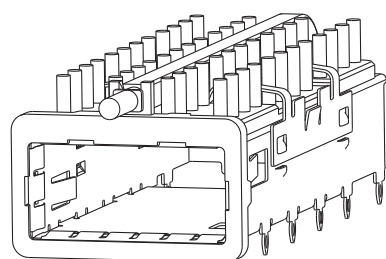

Behind-Bezel Cage with Heat Sink and Lightpipe

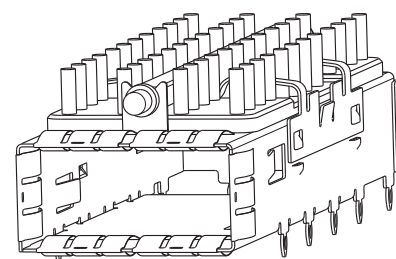

Through-Bezel Cage with Heat Sink and Lightpipe

QSFP Cage Kits

Part Number	Bezel Mount	Heat Sink	Max. Height	Lightpipe
1888617-1	Through-bezel	None	—	None
1888674-1	Through-bezel	None	—	Customer Applied
1888631-1	Through-bezel	PCI	13.7 mm	None
1888631-2	Through-bezel	SAN	16.0 mm	None
1888631-3	Through-bezel	Networking	23.0 mm	None
1888971-1	Through-bezel	SAN	16.0 mm	Dual Lightpipe
1888971-2	Through-bezel	Networking	23.0 mm	Dual Lightpipe
1888971-3	Through-bezel	PCI	13.7 mm	Dual Lightpipe
1888972-1	Through-bezel	SAN	16.0 mm	Single Lightpipe
1888972-2	Through-bezel	Networking	23.0 mm	Single Lightpipe
1888972-3	Through-bezel	PCI	13.7 mm	Single Lightpipe
1888781-1	Behind-bezel	None	—	None
1888968-1	Behind-bezel	PCI	13.7 mm	None
1888968-2	Behind-bezel	SAN	16.0 mm	None
1888968-3	Behind-bezel	Networking	23.0 mm	None
2110487-1*	Through-bezel	No	Closed Top	None

*Solder

Accessories

Part Number	Description
1888634-1	Single Lightpipe
2007309-1	Dual Lightpipe
2007304-1	Heat Sink Clip

Note: All part numbers are RoHS compliant.

QSFP Cages and Connectors (Continued)

Cages (Continued)

Cage Applications:

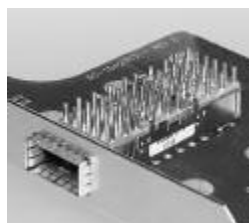

Through Bezel



Behind Bezel



Ganged QSFP Cages Behind Bezel

Part Number	Configuration	Heat Sink	Max. Height of Heat Sink Above Board	Lightpipe
2057042-1	1x3	PCI	13.7 mm	Included
2057042-2	1x3	SAN	16.0 mm	Included
2057042-3	1x3	Networking	23.0 mm	Included
2007456-1	1x3	PCI	13.7 mm	None
2007456-2	1x3	San	16.0 mm	None
2007456-3	1x3	Networking	23.0 mm	None
2007473-1	1x3	None	—	Option for lightpipe attachment*
2007474-1	1x3	None	—	None
2057183-1	1x4	PCI	13.7 mm	Included
2057183-2	1x4	SAN	16.0 mm	Included
2057183-3	1x4	Networking	23.0 mm	Included
2007625-1	1x4	PCI	13.7 mm	None
2007625-2	1x4	SAN	16.0 mm	None
2007625-3	1x4	Networking	23.0 mm	None
2007668-1	1x4	None	—	Option for lightpipe attachment*
2007667-1	1x4	None	—	None
2143330-1	1x6	PCI	13.7 mm	none
2143330-2	1x6	SAN	16.0 mm	none
2143330-3	1x6	Networking	23.0 mm	none
2143331-1	1x6	PCI	13.7 mm	included**
2143331-2	1x6	SAN	16.0 mm	included**
2143331-3	1x6	Networking	23.0 mm	included**

* Sold separately ** Square profile

Ganged QSFP Cages Through-bezel

2170024-1	1x4	no	Closed top	none
-----------	-----	----	------------	------

Dual Lightpipe

Part Number	Recommended LED Height
2007477-3	0.8 – 1.1 mm

Note: Other lightpipe options available.

Part Number	Configuration	Remarks
2110819-1	38 pos	Provides extra margin at 10 Gb applications and support for 14 Gb IB



EMI/Dust Plug Part Number 1888810-2

- Provides EMI containment for unused ports
- Keeps interface free of contamination or debris
- Ergonomic Design



Connector Part Number 1761987-9 and 2110819-1

- Tape and reel packaged for pick and place SMT processing
- 38 position EVERCLEAR connector
- Designed to optimize signal integrity through 10 Gb/s

PCI is a trademark of PCI-SIG.

Note: All part numbers are RoHS compliant.

MPO Optical Connectors and Cable Assemblies

QSFP Optical Jumper

- Uses 50/125µm MM fiber (500MHz-km BW at 850nm and 1300nm wavelengths) with OFNR-rated jacket
- Fiber path is reversed (1 to 12, 2 to 11, 3 to 10, 4 to 9, fibers 5, 6, 7, 8 not used)



Other options include

- Custom lengths
- High bandwidth cable (up to 2000MHz-km)
- OFNP rated jacket
- Fanout to LC for interface to SFP optical ports

MPO to MPO Suitable for Interface to Transceiver

Part Number	Standard Length
1938208-1	1 m
1938208-5	5 m
1-1938208-0	10 m
2-1938208-0	20 m
5-1938208-0	50 m

Note: See drawing for part numbers of other standard lengths.

Note: All part numbers are RoHS compliant.

Generation II PARALIGHT QSFP+ Active Optical Cable Assemblies

Applications

- High performance computing clusters
- Supercomputers
- High end servers
- Mass storage
- Metro network switch/cross connect
- High end carrier class routers
- SDR, DDR, and QDR InfiniBand applications
- Other 2.5–10.0 Gb/s applications (e.g. 10 Gb Fibre Channel ISL or 10 Gig Ethernet XAUI on ports providing InfiniBand pinout 3.3 V power)

Optical/Electrical

- 40 Gb/s bidirectional
- Compatible with SDR, DDR, and QDR InfiniBand applications
- Low power consumption — under 1 watt per end

Mechanical/Environmental

- Up to 100 meters
- 25 mm bend radius
- Operating temperature 0°C to 70°C
- Storage temperature -20°C to 85°C
- 4 channels each direction

Materials

- OFNP/CSA-FT-6 (plenum) cable
- OFN-LS (LSZH rated) cable available upon request



Length (Meters)	Cable Type	10 Gb/s QSFP-QSFP
1	OFNP*	1-2123287-2
2	OFNP*	2123287-1
3	OFNP*	2123287-2
5	OFNP*	2123287-3
7	OFNP*	1-2123287-3
10	OFNP*	2123287-4
15	OFNP*	2123287-5
20	OFNP*	2123287-6
25	OFNP*	2123287-7
30	OFNP*	2123287-8
40	OFNP*	2123287-9
50	OFNP*	1-2123287-0
100	OFNP*	1-2123287-1

*OFNP = Optical Fiber Nonconductive Plenum

Fibre Channel is a trademark of the Fibre Channel Industry Association.

INFINIBAND is a trademark of the InfiniBand Trade Association.

XAUI is a trademark of the 10Gigabit Ethernet Alliance XAUI Interoperability Group.

Note: All part numbers are RoHS compliant.

56 Gb/s QSFP+ Active Optical Cable Assemblies

Applications

- High performance computing clusters
- Supercomputers
- High end servers
- Mass storage
- Metro network switch/cross connect
- High end carrier class routers
- SDR, DDR, QDR, and FDR InfiniBand applications
- Other 2.4–14.1 Gb/s Applications (e.g. 10 Gb Fibre Channel or 10 Gig Ethernet XAUI on ports providing InfiniBand pinout 3.3 V power)

Optical/Electrical

- 56 Gb/s bidirectional
- Compatible with SDR, DDR, QDR, and FDR InfiniBand applications
- Low power consumption — under 1 watt per end

Mechanical/Environmental

- Up to 100 meters
- 25 mm bend radius
- Operating temperature 0°C to 70°C
- Storage temperature -20°C to 85°C
- 4 channels each direction

Materials

- OFNP/CSA-FT-6 (plenum) cable
- OFN-LS (LSZH rated) cable available upon request



Length (Meters)	Cable Type	14 Gb/s QSFP-QSFP
3	OFNP*	2123541-2
5	OFNP*	2123541-3
7	OFNP*	1-2123541-3
10	OFNP*	2123541-4
15	OFNP*	2123541-5
20	OFNP*	2123541-6
25	OFNP*	2123541-7
30	OFNP*	2123541-8
40	OFNP*	2123541-9
50	OFNP*	1-2123541-0
100	OFNP*	1-2123541-1

*OFNP = Optical Fiber Nonconductive Plenum

Fibre Channel is a trademark of the Fibre Channel Industry Association.

INFINIBAND is a trademark of the InfiniBand Trade Association.

XAUI is a trademark of the 10Gigabit Ethernet Alliance XAUI Interoperability Group.

Note: All part numbers are RoHS compliant.

40 Gb/s QSFP+ Optical Transceiver

Applications

- High-speed interconnects within and between switches, routers and transport equipment
- Server-Server Clusters, Super-computing interconnections
- Proprietary backplanes
- Interconnects rack-to-rack, shelf-to-shelf, board-to-board, board-to-optical backplane
- 10GBASE-SR applications
- 40GBASE-SR4 applications
- InfiniBand SDR, DDR and QDR applications

Optical/Electrical

- 40 Gb/s bidirectional
- Compatible with SDR, DDR, QDR, and FDR InfiniBand applications and Ethernet 10GBASE-SR and 40GBASE-SR4
- Low power consumption — typical power under 1 watt

Mechanical/Environmental

- Operating temperature 0°C to 70°C
- Storage temperature -20°C to 85°C
- 4 channels each direction



Part Number	Description
2156043-1	40 Gb/s QSFP+ Transceiver (4 channels x 10.3125 Gbps)

Block Diagram

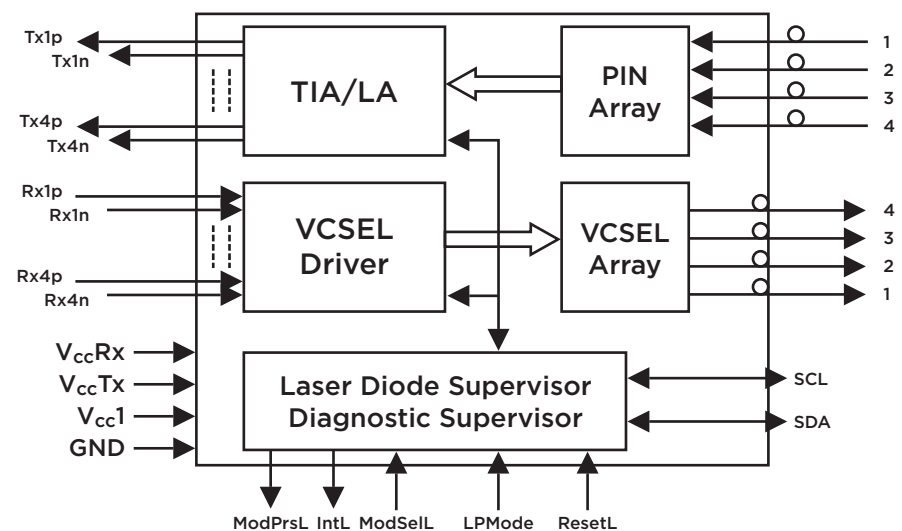

INFINIBAND is a trademark of the InfiniBand Trade Association.

Note: All part numbers are RoHS compliant.

CFP Compliant 40G & 100G Ethernet Connectors and Components

Product Facts

- Electronics high speed 148 position connector, supporting 10Gb/s per channel
- Plug connector straddle mounts to the optical transceiver module printed circuit board for conventional processing
- Receptacle connector is surface mount (SMT) processed to the host board for conventional processing
- Design supports belly-to-belly port positioning (mounted on both sides of host board) for high density
- Accepts all CFP MSA compliant optical transceivers
- Provides EMI shielding at the host connector interface and at the bezel opening via integrated EMI gasketing

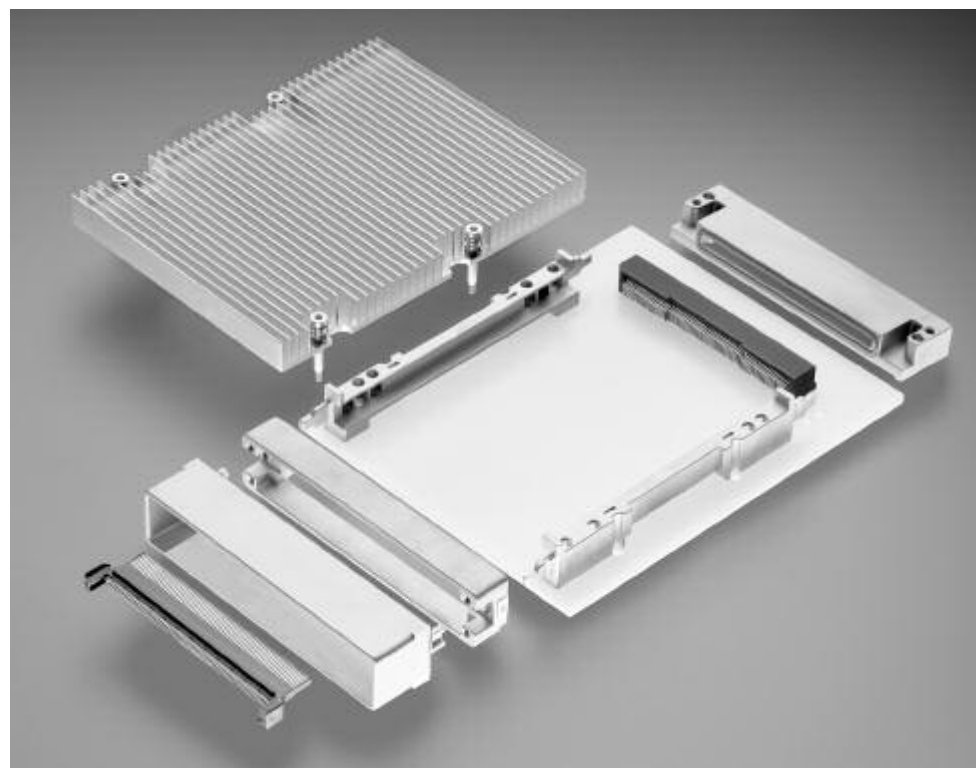

The CFP compliant connector is a new ultra high speed pluggable I/O interface supporting 40 and 100 Gb/s ethernet applications. The integrated system provides the mechanical, EMI and

thermal performance necessary to meet the demanding requirements of the CFP Multi Source Agreement (MSA) Optical Transceivers and OEM host line cards.

Technical Documents

Application Specifications

114—13262
114—13263

Product Specifications

108-2399

Part Number	Description
2057629-1	CFP Module Connector Plug
2057630-1	CFP Host Board Receptacle Connector
2057592-2	CFP Guide Rail
2057631-1	CFP Receptacle Cover
2057626-1	CFP External Bracket Assembly
2057930-1	CFP Backer Plate Assembly
1963856-1	CFP Riding Heat Sink
2180467-1	External Bracket Screws (4 Required)
2180467-1	Screw 2-56 UNC x .375 Stainless Steel
2149151-1	Dust Cover CFP Host Assembly
2110903-1	CFP Heat Sink
2110255-2	CFP Rail Insert

Kits

Part Number	Description
2132404-1	CFP Host Kit with Heat Sink
2169666-1	CFP Host Kit without Heat Sink, without Screws
2169666-2	CFP Host Kit without Heat Sink, with Screws

Note: All part numbers are RoHS compliant.

CXP Products

Product Facts

- Standard CXP interface complies with InfiniBand CXP 12x QDR and IEEE 100 Gbps Ethernet
- Provides 12 channels of 10 Gbps data rates for 120 Gbps of total bandwidth in one-piece press-fit assembly
- Dual-sourced, Enhanced Footprint (EF) offers reduced cross-talk
- Pre-assembled (one-piece) connector and cage assembly offers one-step placement to the board
- EMI gasketing at bezel opening and EMI springs for plug-to-receptacle containment
- CXP cages accommodate belly-to-belly mounting (can be applied to both sides of the board)
- Offering includes multiple heat sink, lightpipe and EMI/dust plug options to fit customer applications

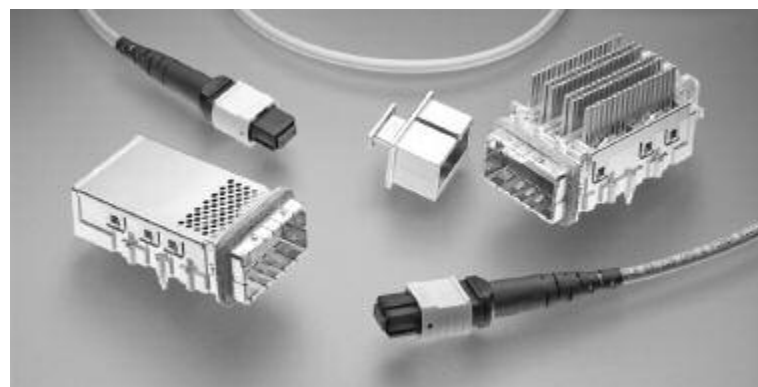

TE Connectivity's CXP connector and cage assembly offers 12 channels of 10 Gbps data rates for 120Gbps of total bandwidth in one-piece press-fit assembly. TE's CXP system complies with InfiniBand CXP 12x QDR and IEEE 100 Gbps Ethernet standards and enables pluggable copper or optical cable options. The system has been engineered for

applications in high-speed data environments with EMI gasketing at bezel opening and EMI springs for plug-to-receptacle containment. It provides one-step placement to the host board and comes with multiple heat sink, lightpipe and EMI/dust plug options. Enhanced EF, dual sourced footprint offers reduced cross-talk and improved electrical performance.

TE also offers a complement of fiber optic cable assemblies with CXP fiber paths to interconnect CXP transceivers to CXP, QSFP+ and SFP+ transceivers. All are available with OM2 and OM3 fiber as a standard offering, with OM4 being available upon request.

Product Applications

- Controller Cards and Servers
- Network Switches
- Routers
- Storage Devices
- Direct Attached Storage (DAS)
- Storage Attached Networks (SAN)
- Network Attached Storage (NAS)

INFINIBAND is a trademark of the InfiniBand Trade Association.

CXP Products (Continued)

Product Offering



Belly-to-Belly Version

CXP Connector

Part Number	Part Description	Height	Profile	Cover	Heat Sink	Light Pipes
2149126-3	EMI / DUST COVER	—	—	—	—	—
2149448-1	CXP receptacle Assembly	11.88mm	Standard	No	No	No
2149152-1	CXP receptacle Assembly	11.88mm	Standard	Yes	No	No
2149157-1	CXP receptacle Assembly	14.37mm	Standard	No	Yes	No
2149157-3	CXP receptacle Assembly	16.5mm	Standard	No	Yes	No
2149157-5	CXP receptacle Assembly	23.5mm	Standard	No	Yes	No
2149159-1	CXP receptacle Assembly	16.37mm	Standard	Yes	No	Yes
2149159-3	CXP receptacle Assembly	16.37mm	Standard	No	Yes	Yes
2149159-5	CXP receptacle Assembly	16.5mm	Standard	No	Yes	Yes
2149159-7	CXP receptacle Assembly	23.5mm	Standard	No	Yes	Yes
2149699-1	CXP receptacle Assembly	11.55mm	Belly-to-Belly (standard)	Yes	No	No
2149701-1	CXP receptacle Assembly	11.3mm	Belly-to-Belly (standard)	No	No	No
2149731-1	CXP receptacle Assembly	11.55mm	Belly-to-Belly (extended)	Yes	No	No
2149733-1	CXP receptacle Assembly	11.3mm	Belly-to-Belly (extended)	No	No	No

CXP Fiber Optic Cable Assemblies

Part Number	Part Description
2148039-x	CXP 24Fiber C/A, 50/125µm OM2, MPO (f) -MPO (f)
2148238-x	CXP 24Fiber C/A, 50/125µm OM3, MPO (f) -MPO (f)
2148040-x	CXP-SFP+ 24Fiber C/A, 50/125µm OM2, MPO (f) - LC
2148041-x	CXP-SFP+ 24Fiber C/A, 50/125µm OM3, MPO (f) - LC
2148042-x	CXP-QSFP+ 24Fiber C/A, 50/125µm OM2, 24 pos MPO (f) to 3 (8fiber) MPO (f)
2148043-x	CXP-QSFP+ 24Fiber C/A, 50/125µm OM3, 24 pos MPO (f) to 3 (8fiber) MPO (f)
2123248-1	CXP 24 Fiber Loopback

Note: For -X see cable length chart below.

CXP Fiber Optic Cables Length Chart (Dash Numbers = Length in Meters)

1 -50 Meters Length				50 - 100 Meters Length	
Base PN	Length	Base PN	Length	Base PN	Length
xxxxxxx-1	1 meter	2-xxxxxxx-6	26 meters	5-xxxxxxx-5	55 meters
xxxxxxx-2	2 meters	2-xxxxxxx-7	27 meters	6-xxxxxxx-0	60 meters
xxxxxxx-3	3 meters	2-xxxxxxx-8	28 meters	6-xxxxxxx-5	65 meters
xxxxxxx-4	4 meters	2-xxxxxxx-9	29 meters	7-xxxxxxx-0	70 meters
xxxxxxx-5	5 meters	3-xxxxxxx-0	30 meters	7-xxxxxxx-5	75 meters
xxxxxxx-6	6 meters	3-xxxxxxx-1	31 meters	8-xxxxxxx-0	80 meters
xxxxxxx-7	7 meters	3-xxxxxxx-2	32 meters	8-xxxxxxx-5	85 meters
xxxxxxx-8	8 meters	3-xxxxxxx-3	33 meters	9-xxxxxxx-0	90 meters
xxxxxxx-9	9 meters	3-xxxxxxx-4	34 meters	9-xxxxxxx-5	95 meters
1-xxxxxxx-0	10 meters	3-xxxxxxx-5	35 meters	9-xxxxxxx-9	100 meters
1-xxxxxxx-1	11 meters	3-xxxxxxx-6	36 meters		
1-xxxxxxx-2	12 meters	3-xxxxxxx-7	37 meters		
1-xxxxxxx-3	13 meters	3-xxxxxxx-8	38 meters		
1-xxxxxxx-4	14 meters	3-xxxxxxx-9	39 meters		
1-xxxxxxx-5	15 meters	4-xxxxxxx-0	40 meters		
1-xxxxxxx-6	16 meters	4-xxxxxxx-1	41 meters		
1-xxxxxxx-7	17 meters	4-xxxxxxx-2	42 meters		
1-xxxxxxx-8	18 meters	4-xxxxxxx-3	43 meters		
1-xxxxxxx-9	19 meters	4-xxxxxxx-4	44 meters		
2-xxxxxxx-0	20 meters	4-xxxxxxx-5	45 meters		
2-xxxxxxx-1	21 meters	4-xxxxxxx-6	46 meters		
2-xxxxxxx-2	22 meters	4-xxxxxxx-7	47 meters		
2-xxxxxxx-3	23 meters	4-xxxxxxx-8	48 meters		
2-xxxxxxx-4	24 meters	4-xxxxxxx-9	49 meters		
2-xxxxxxx-5	25 meters	5-xxxxxxx-0	50 meters		

Technical Documents

Application Specifications

114-13283



Product Specifications

108-2426

Note: All part numbers are RoHS compliant.

XFP Products

Product Facts

- 10 Gb/s serial link
- EMI containment features
 - Module to XFP Cage
 - XFP Cage to Chassis
- Uses 30 pin surface mount connector
- Riding heat sink for thermal management
- Press fit cage termination
- Designed to support belly-to-belly applications
- UL/CSA Report File E28476  



XFP was developed to provide 10Gb/s serial links for a wide range of applications including standards such as OC192/STM-64, G.709, and 10 Gigabit Ethernet.

The cage /plug interface features an intuitive latch system, gasketing features for excellent EMI contain-

ment, and was the first pluggable interface to incorporate patented riding heat sink technology for thermal dissipation. The heat sink is mounted to the cage using a clip, which provides a load to maintain contact between heat sink and module. Heat sinks are

available in three heights, and custom heat sinks are possible. This heat sink technology has extended to SFP and QSFP applications. The XFP connector is a 30 position PT connector, using the same design as used in SFP.

Technical Documents

Instruction Sheet
408-8723

Application Specification
114-13096

Product Specifications
108-2127

XFP Standard
SFF Document INF-8077

Cages/Cage Assemblies

Part Number	Description	PCB Attachment
1489951-1	XFP Cage Rectangular Latch	Press Fit
1658871-1	XFP Cage w/Insulating Tape	Press Fit
1888101-1	XFP Cage without rear gasket	Press Fit
1658945-1	XFP Cage w/Insulating Tape & without Rear Gasket	Press Fit
1888116-1	XFP Kit: XFP Cage with SAN Heat Sink (6.5 mm)	Press Fit
1888116-2	XFP Kit: XFP Cage with PCI Heat Sink (4.2 mm)	Press Fit
1888065-1	XFP Kit: XFP Cage with Networking Heat Sink (13.5 mm)	Press Fit
1888481-1	XFP Kit: XFP Cage w/Insulating Tape and SAN Heat Sink (6.5mm)	Press Fit
1888481-2	XFP Kit: XFP Cage w/Insulating Tape and PCI Heat Sink (4.2mm)	Press Fit
1888481-3	XFP Kit: XFP Cage w/Insulating Tape and Networking Heat Sink (13.5 mm)	Press Fit
2170125-1	XFP Kit: XFP Cage with Heat Sink (10.0 mm)	Press Fit

Connectors, Heat Sinks, and Accessories

Part Number	Description
788862-1	30 Pos SMT XFP Conn. .38 µm (15 µin) gold plating
788862-2	30 Pos SMT XFP Conn. .76 µm (30 µin) gold plating
1367500-1	30 Pos SMT XFP Conn. .76 µm (30 µin) gold plating with contact treatment, for enhanced contact for high speed signals
1489948-2	XFP Heat Sink Clip
1888810-2	XFP EMI/Dust Plug
1542618-2	SAN Heat Sink (6.5 mm)
1542656-2	PCI Heat Sink (4.2 mm)
1542706-2	Networking Heat Sink (13.5 mm)
1963850-2	XFP Heat Sink (10.0 mm)

PCI is a trademark of PCI-SIG.

Note: All part numbers are RoHS compliant.

X2 Standard Guide Rails and Connectors

Product Facts

- XAUI-based, 4 channels at 3.125 Gb/s
- Supports X2 MSA
- Uses 70 position SMT connector
- EMI spring gasket provides shielding to X2 compliant module
- Die cast (screw mount) and stamped (press-fit) designs available
- Application tooling available
- Belly-to-belly mounting possible

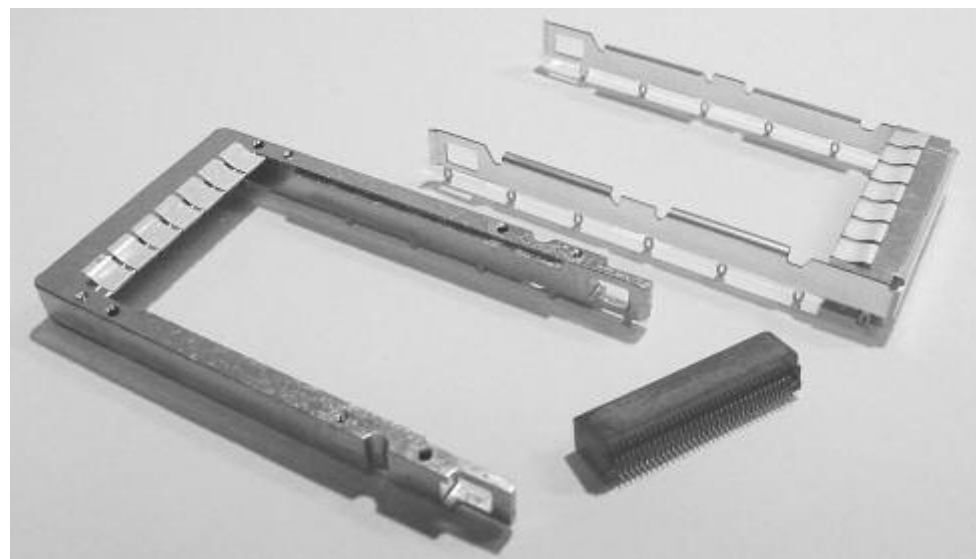

Technical Documents

- Instruction Sheets**
 408-10102 X2 Die Cast Guide Rails
 408-8997 X2 Press-fit Guide Rails

TE offers a guide rail system that meets X2 standard specifications. X2 standard is a XAUI-based system that offers four channels of data throughput operating up to 3.125 Gb/s. The guide rail and connector are used in conjunction with an X2 compliant module.

TE offers both a stamped guide rail which is designed for press-fit application, and a robust die cast rail which is screw-mounted. The connector is a 70 position PT connector, using the same design as used in SFP.

Rails

Part Number	PCB Configuration	Material	PCB Attachment
1367610-1	Belly-to-Belly	Stamped Copper Alloy, Tin Plate	Press Fit
1367608-1	Standard	Stamped Copper Alloy, Tin Plate	Press Fit
1367709-1	Standard	Die Cast Zinc Alloy, Nickel Plate	Screw Mount
1367710-1	Belly-to-Belly	Die Cast Zinc Alloy, Nickel Plate	Screw Mount

Connectors

Part Number	Description
1367337-1	70 pin, surface mount connector; 0.38 µm (15 µin) gold plating
1367337-2	70 pin, surface mount connector; 0.76 µm (30 µin) gold plating
1658198-1	70 pin, surface mount connector; 0.76 µm (30 µin) gold plating with surface treatment

XAUI is a trademark of the 10Gigabit Ethernet Alliance XAUI Interoperability Group.

Note: All part numbers are RoHS compliant.

Mini SAS HD Receptacle Assembly

Product Facts

- SFF-8644 and SAS 2.1 compliant and capable for SAS 3.0
- Board band design for 6 and 12 Gbps
- Board receptacle assembly provide 1x1(4x), 1x2(8x) and 1x4(16x) configuration
- Pre-assembled, one piece connector and cage assembly offers one-step placement to the board
- Lightpipe option available
- REACH and RoHS compliant
- Improved cable latch design
- Enhanced EMI skirt design
- Scalable 4x and 8x cable plug options
- 26, 28, and 30 AWG bulk cable

Applications

- Serial Attached SCSI (SAS 2.1)
- Serial data transmission
- HBA (Host Bus Adapter)
- RAID (Redundant Arrays of Inexpensive Disks)
- Workstations
- Rack-mount server
- Servers
- Storage rack
- High performance computer
- Switches

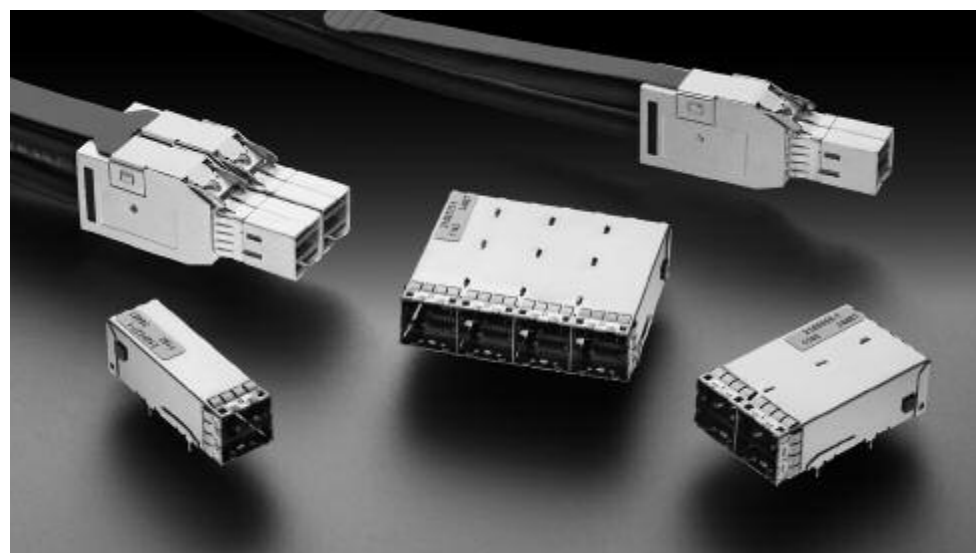

TE's Mini SAS HD receptacle assembly is the next-generation SAS high-density high-speed IO interface. This interface was adopted for the SAS 2.1 standard and proposed for SAS 3.0 standard, and is designed to support 6G and future 12G SAS applications. The assembly is offered in 4x, 8x, and 16x versions. The reduced size of the Mini SAS HD system provides

additional space for system designers. While a standard PCIe card can accept four 4x Mini SAS connectors, a low-profile PCIe card can only accept two of the same connectors.

The passive Mini SAS HD copper cable assembly is designed for broadband operation optimized for 6 and 12 Gbps. The EEPROM signature enables the host

to identify what type and length of cable is connected to its port, and can be customized for any application. An improved latch design reduces the insertion force and increases the retention force. Cable assemblies are available with MADISON CABLE brand TURBOTWIN or INFINITWIST bulk cable.

Technical Documents

Product Specification

108-2462

Application Specification

114- 13316

Industry Standards

SAS 2.1
SFF-8644

Mini SAS HD Receptacle Assembly (Continued)



Mini SAS HD Receptacle Assembly Part Number Selection Guide

Part Number	Product Description	Lightpipe
2149027-1	Mini SAS HD 1x1 Receptacle Assembly	No
2149966-1	Mini SAS HD 1x2 Receptacle Assembly	No
2149375-1	Mini SAS HD 1x4 Receptacle Assembly	No
2198484-1	Mini SAS HD 1X1 Receptacle Assy W/LP	Yes
2198483-1	Mini SAS HD 1x2 Receptacle Assy w/ LP	Yes
2180736-1	Mini SAS HD 1x4 Receptacle Assy w/ LP	Yes

Mini SAS HD Copper Cable Assembly Part Number Selection Guide

The following Mini SAS HD copper cable assemblies use Madison Cable brand TURBOTWIN bulk cable

Base Part Number	Description	Data Rate	AWG	Minimum Cable Length	Maximum Cable Length
2202501-1 thru -8	4x Passive Mini SAS HD	6/12 Gbps	26	0.5m	7m
2202502-1 thru -6	4x Passive Mini SAS HD	6/12 Gbps	28	0.5m	5m
2202503-1 thru -4	4x Passive Mini SAS HD	6/12 Gbps	30	0.5m	3m
2202504-1 thru -8	8x Passive Mini SAS HD	6/12 Gbps	26	0.5m	7m
2202505-1 thru -6	8x Passive Mini SAS HD	6/12 Gbps	28	0.5m	5m
2202506-1 thru -4	8x Passive Mini SAS HD	6/12 Gbps	30	0.5m	3m
2202507-1 thru -8	4x Passive Mini SAS HD Hybrid	6 Gbps	26	0.5m	7m
2202508-1 thru -6	4x Passive Mini SAS HD Hybrid	6 Gbps	28	0.5m	5m
2202509-1 thru -4	4x Passive Mini SAS HD Hybrid	6 Gbps	30	0.5m	3m

The following Mini SAS HD copper cable assemblies use Madison Cable brand INFINITWIST bulk cable

Base Part Number	Description	Data Rate	AWG	Minimum Cable Length	Maximum Cable Length
2163479-1 thru -8	4x Passive Mini SAS HD	6/12 Gbps	26	0.5m	7m
2163480-1 thru -6	4x Passive Mini SAS HD	6/12 Gbps	28	0.5m	5m
2163481-1 thru -4	4x Passive Mini SAS HD	6/12 Gbps	30	0.5m	3m
2163483-1 thru -8	8x Passive Mini SAS HD	6/12 Gbps	26	0.5m	7m
2163484-1 thru -6	8x Passive Mini SAS HD	6/12 Gbps	28	0.5m	5m
2163485-1 thru -4	8x Passive Mini SAS HD	6/12 Gbps	30	0.5m	3m
2163487-1 thru -8	4x Passive Mini SAS HD Hybrid	6 Gbps	26	0.5m	7m
2163488-1 thru -6	4x Passive Mini SAS HD Hybrid	6 Gbps	28	0.5m	5m
2163489-1 thru -4	4x Passive Mini SAS HD Hybrid	6 Gbps	30	0.5m	3m

Note: All part numbers are RoHS compliant.

Mini SAS High Speed Interconnect and Cable Assemblies

Product Facts

- 26 and 36 position receptacles
- High density 0.8mm contact spacing
- Up to 6Gbps data rate
- Supports trained and untrained systems per
- SAS 2.0 and SAS 2.1 specifications
- Cables lengths from 0.5m through 10m
- Bulk cable ranges from 30 AWG to 24 AWG

Applications

- High Speed I/O
- Multiple Channels Interconnects
- Switches for Fibre Channel and InfiniBand Standards
- External SAS and SATA
- Data centers
- Storage systems
- Servers



TE's mini SAS product family is a high-speed multi-lane connector system for both internal and external solutions, including both

receptacles and cable assemblies. The system is designed to be compliant to SFF-8086 and 8088 standards.

Connector Part Number Chart

Connector	1 Port	2 Port	3 Port	4 Port
Receptacle (26 position)	1761987-7	1761987-7	1761987-7	1761987-7
Shield (universal key #4)*	1888321-1	1888321-2	1888321-3	1888321-4

* Other key and port configurations available, see TE Connectivity dwg 1888321

Cable Assemblies Parts Chart

Type	Part Number	Length	AWG	Key Slots		Key Rib	
				P1	P2	P1	P2
Mini SAS to Mini SAS Standard Key Slots	2127833-1	0.5m	30	2-4	4-6	—	—
	2127833-2	1.0m	30	2-4	4-6	—	—
	2127833-3	1.5m	28	2-4	4-6	—	—
	2127833-4	2.0m	28	2-4	4-6	—	—
	2127833-5	2.5m	28	2-4	4-6	—	—
	2127833-6	3.0m	28	2-4	4-6	—	—
	2127833-7	4.0m	28	2-4	4-6	—	—
	2127833-8	5.0m	24	2-4	4-6	—	—
	2127833-9	6.0m	24	2-4	4-6	—	—
	1-2127833-0	7.0m	24	2-4	4-6	3	3
1-2127833-1	8.0m	24	2-4	4-6	3	3	
1-2127833-2	9.0m	24	2-4	4-6	3	3	
1-2127833-3	10.0m	24	2-4	4-6	3	3	
Mini SAS to Mini SAS Universal Key Slots	1-2127833-4	0.5m	30	2-4-6	2-4-6	—	—
	1-2127833-5	1.0m	30	2-4-6	2-4-6	—	—
	1-2127833-6	1.5m	28	2-4-6	2-4-6	—	—
	1-2127833-7	2.0m	28	2-4-6	2-4-6	—	—
	1-2127833-8	2.5m	28	2-4-6	2-4-6	—	—
	1-2127833-9	3.0m	28	2-4-6	2-4-6	—	—
	2-2127833-0	4.0m	28	2-4-6	2-4-6	—	—
	2-2127833-1	5.0m	24	2-4-6	2-4-6	—	—
	2-2127833-2	6.0m	24	2-4-6	2-4-6	—	—
	2-2127833-3	7.0m	24	2-4-6	2-4-6	3	3
	2-2127833-4	8.0m	24	2-4-6	2-4-6	3	3
	2-2127833-5	9.0m	24	2-4-6	2-4-6	3	3
	2-2127833-6	10.0m	24	2-4-6	2-4-6	3	3

Technical Documents

Product Specification

108-2234

Qualification Test Report

501-638

Industry Standards

SFF-8088 – External 26 position Mini SAS with keys

Fibre Channel is a trademark of the Fibre Channel Industry Association.

INFINIBAND is a trademark of the InfiniBand Trade Association.

Note: All part numbers are RoHS compliant.

Part Number Index

Note: This index lists all cataloged parts by base no. only. Complete part nos. (with prefixes and/or suffixes) are shown on the page(s) indicated.

Part No.	Page	Part No.	Page	Part No.	Page
502716	24	1888321	44	2007667	32
788862	40	1888481	40	2007668	32
1367073	15-17, 21	1888617	31	2032757	13
1367147	12, 15, 16, 21	1888631	31	2053453	29
1367337	41	1888634	31	2053638	29
1367500	40	1888674	31	2057021	9
1367608	41	1888781	31	2057042	32
1367610	41	1888810	32, 40	2057085	11
1367629	15, 16	1888901	12	2057086	9, 11
1367643	21	1888968	31	2057112	11
1367645	21	1888971	31	2057159	9
1367646	21	1888972	31	2057161	11
1367709	41	1918403	24	2057183	32
1367710	41	1918404	23	2057353	11
1374737	24	1918405	23	2057458	11
1489669	15, 16	1918406	23	2057555	11
1489779	15	1918407	23	2057556	11
1489948	40	1918918	24	2057592	37
1489951	40	1932002	15	2057626	37
1489962	15	1932068	20	2057629	37
1542618	40	1932069	20	2057630	37
1542656	40	1938208	33	2057631	37
1542706	40	1938323	25	2057833	9, 11
1551892	28	1938324	25	2057930	37
1551920	28	1948134	22	2064862	25
1588153	24	1963850	40	2064863	25
1658197	15, 17, 21	1963856	37	2064877	25
1658198	41	2007093	9	2064880	25
1658390	19, 20	2007132	9	2064883	25
1658391	19, 20	2007135	9	2064886	25
1658628	19, 20	2007169	9	2064889	25
1658629	19, 20	2007170	9	2064937	23
1658723	17	2007178	9	2064938	23
1658744	17	2007180	9	2110058	11
1658758	19	2007181	9	2110255	37
1658859	19	2007193	9	2110304	9
1658871	40	2007194	9	2110487	31
1658894	19	2007198	9	2110759	10
1658895	19	2007215	9	2110819	32
1658939	17	2007250	9	2110903	37
1658945	40	2007251	9	2110957	17
1754371	24	2007254	9	2123248	39
1754625	24	2007262	9	2123287	34
1761007	17	2007263	9	2123541	35
1761008	17	2007277	9	2127833	44
1761011	17	2007304	31	2127931	13
1761012	17	2007309	31	2127932	13
1761013	17	2007394	12	2127933	13
1761014	17	2007399	12	2127934	13
1761015	17	2007417	12	2132404	37
1761327	19	2007456	32	2143330	32
1761394	12, 17, 20	2007464	9	2143331	32
1761987	32, 44	2007473	32	2143438	17, 21
1828184	24	2007474	32	2148039	39
1828456	24	2007477	32	2148040	39
1829903	21	2007492	12	2148041	39
1829904	21	2007498	17	2148042	39
1829905	21	2007538	12	2148043	39
1888065	40	2007562	12	2148238	39
1888101	40	2007567	12	2149027	43
1888116	40	2007625	32	2149060	17
1888247	9, 15, 17, 21	2007637	12	2149126	39

Part Number Index (Continued)

Part No.	Page	Part No.	Page	Part No.	Page
2149151	37	2170024	32	2198346	7
2149152	39	2170088	6	2198373	28
2149157	39	2170125	40	2198483	43
2149159	39	2170148	11	2198484	43
2149178	10	2173239	28	2198708	6
2149266	10	2180324	7	2198709	6
2149375	43	2180463	11	2198719	6
2149448	39	2180467	37	2198720	6
2149490	12	2180736	43	2198721	6
2149699	39	2180739	10	2198722	6
2149701	39	2180900	11	2198723	6
2149730	10	2180902	11	2198724	6
2149731	39	2198224	11	2202501	43
2149733	39	2198225	11	2202502	43
2149966	43	2198226	11	2202503	43
2156043	36	2198227	11	2202504	43
2163479	43	2198228	11	2202505	43
2163480	43	2198229	11	2202506	43
2163481	43	2198230	10	2202507	43
2163483	43	2198231	10	2202508	43
2163484	43	2198232	10	2202509	43
2163485	43	2198233	10	5504118	24
2163487	43	2198234	10	6367034	15, 16
2163488	43	2198235	10	6367035	15, 16
2163489	43	2198236	10	6374150	24
2169259	10	2198237	10	6457543	24
2169260	10	2198241	11	6588189	24
2169315	10	2198242	11	6588572	25
2169666	37	2198243	11	6588573	25
2169678	12	2198318	7	6588612	24
2169788	12	2198325	7		
2169851	10	2198339	7		

Engineering Notes





Pluggable Input / Output Solutions

RoHS
Ready 

te.com

© 2012 Tyco Electronics Corporation, a TE Connectivity Ltd. Company. All Rights Reserved.

1773408-1 LUG RRD 3M 5/2012

TE Connectivity and the TE connectivity (logo) are trademarks. Other logos, product and/or company names might be trademarks of their respective owners.



X-ON Electronics

Largest Supplier of Electrical and Electronic Components

Click to view similar products for [Heat Sinks](#) category:

Click to view products by [TE Connectivity](#) manufacturer:

Other Similar products are found below :

[581102B00000G](#) [656-15ABPE](#) [657-20ABPNE](#) [7020B-TC12-MTG](#) [73452PPBA](#) [7G0011A](#) [PF720G](#) [A22-4026](#) [120-1873-007](#) [HAH10L](#)
[HAH15L](#) [1542616-1](#) [HS-2506-F1](#) [HS-87M0-F2](#) [218-40CTE3](#) [231-69PAB-15V](#) [25-7520](#) [SW50-4G](#) [231-75PAB-13V](#) [231-75PAB-15V](#) [253-](#)
[122ABE-22](#) [PSC22CB](#) [HAF10L](#) [HAQ10T](#) [D10100-28](#) [BDN183CBA01](#) [3-21053-4](#) [32438](#) [TX0506-1B](#) [TX1806B](#) [LAE66A3CB](#) [WA-DT2-](#)
[101E](#) [511-3U](#) [73381PPBA](#) [73403PPBA](#) [7G0047C](#) [COMX-440-HSP](#) [510-12M](#) [D10650-40T5](#) [V8511 Y](#) [APF40-40-13CB/A01](#)
[780653U04500G](#) [ATS-54310K-C2-R0](#) [FK 216 CB SA](#) [FK 231 SA 220](#) [648-51AB](#) [657-20ABPESC](#) [2341BG](#) [679-25AG](#) [FK 212 CB SA](#)