

---

**Table of Contents**

---

**AMP multifitting Mark II**

Introduction .....	2002
Direct and Indirect Connection 5.0mm Centerline.....	2003
Derating Curves .....	2004
Keying Plan and Cable Exit .....	2005
Technical Features .....	2006
Direct Mating Connector System .....	2007, 2008
Indirect Mating Connector System.....	2009-2011
PC Board Frame .....	2012

**AMP MONO-SHAPE**

Introduction .....	2013
Connector Versions .....	2014
Tab Connectors .....	2015
Tab Connectors Keying Plan .....	2016
Tab Connector 3-10 Positions .....	2017-2020
Single Way Connectors .....	2021
Single Way Connectors Keying Plan .....	2022
PCB Connectors .....	2023-2027
Satellite Connectors .....	2028
Satellite Connectors Keying Plan .....	2029
Bridge Connectors Keying Plan .....	2030

**AMP MONO-SHAPE Mark II**

Introduction .....	2031
Technical Data .....	2032
Keying Plan and Cable Exit .....	2033
Tab Connector System .....	2034-2035
TAB-BRIDGE Connector System - Short Circuit .....	2036
PCB Connector System .....	2037-2041
Application Tooling .....	2042-2045

**Standard Timer**

Introduction .....	2046
Interior and Exterior Locking.....	2047
Keying Plan .....	2048
Housings .....	2049-2059
Connectors and Contacts .....	2060

### Introduction

#### Product Features

- Direct Mating Connectors for PC Boards, 2–8 Positions, up to 6 A Current Carrying Capacity
- Indirect Mating Connectors, 1–8 Positions, up to 16 A Current Carrying Capacity
- Variable Keying
- Double Wire Termination possible

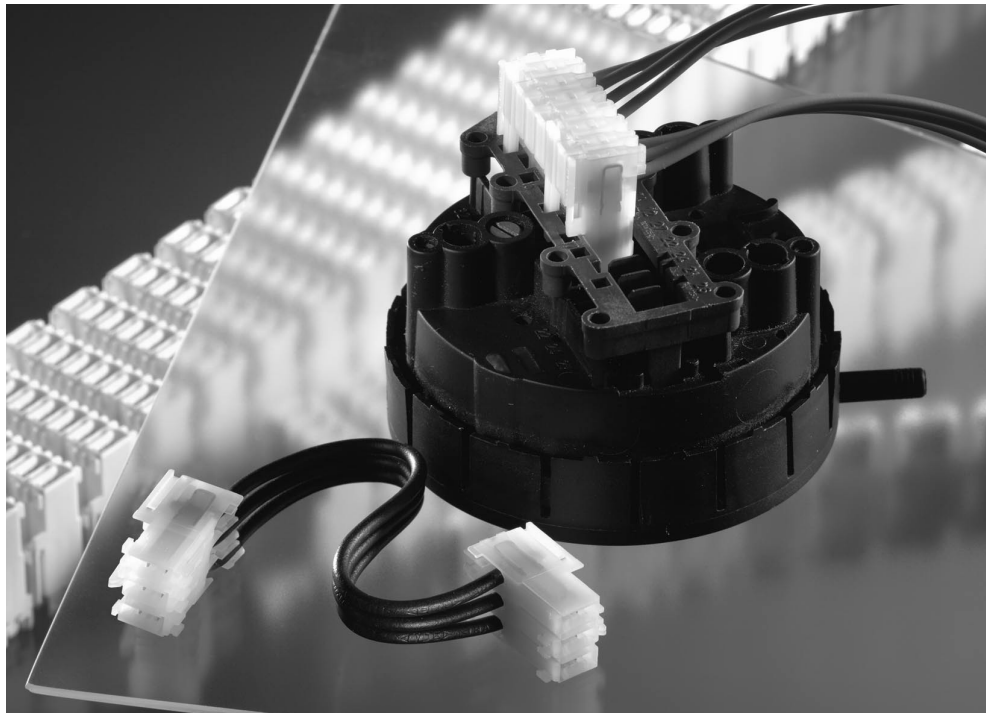

Tyco Electronics' newly designed AMP multifitting Mark II Connector System was developed according to the latest connector design standards.

The requirements of advanced In-Line mating technology for the components and contacts of pc boards are incorporated in the direct and indirect versions of these connector systems.

This system is suitable for a wide wire size range. Current carrying capacity is 16 A maximum.

Double termination is possible with 0.5 and 0.5 mm<sup>2</sup> or 0.5 and 0.75 mm<sup>2</sup> conductors.

The connectors are available in 1- to 8-positions (indirect) resp. 2- to 8-positions (direct) with an exterior locking device.

Interior locking options are available on request.

Supplied in chain and provided with all keying and polarisation ribs, the connectors can be operated economically with modern Application Tooling Equipment.

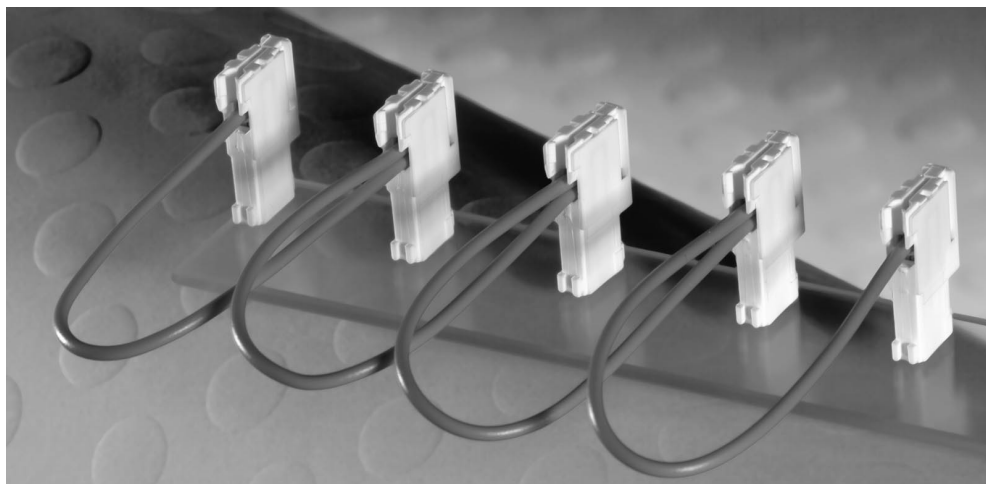

**Direct and Indirect Mating Connection, 5.0 mm Centerline**

**Direct Mating Connection,  
5.0 mm Centerline**

- 1 Double Wire Exit
- 2 Wire Exit 90°
- 3 Wire Exit 180°
- 4 Cover
- 5 Exterior Locking Latch
- 6 Keying
- 7 Polarisation

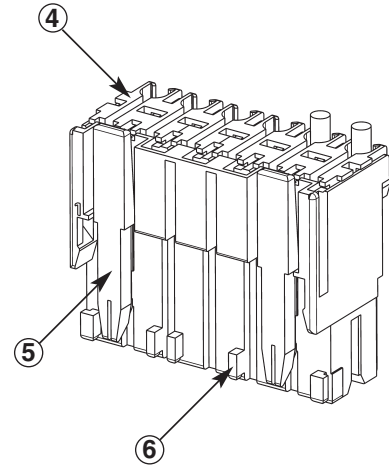
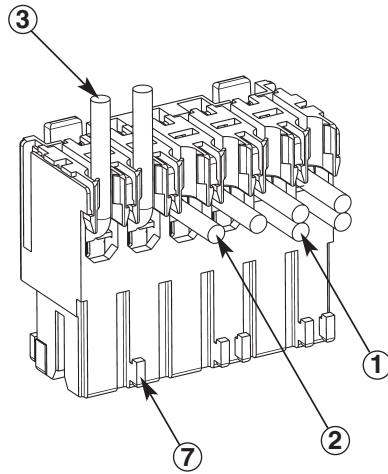

**Indirect Mating Connection,  
5.0 mm Centerline**

- 1 Double Wire Exit
- 2 Wire Exit 90°
- 3 Wire Exit 180°
- 4 Cover
- 5 Exterior Locking Latch
- 6 Keying
- 7 Polarisation

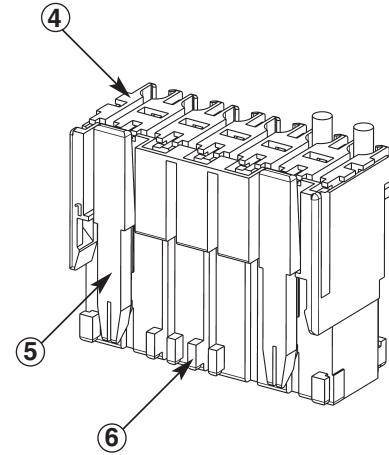
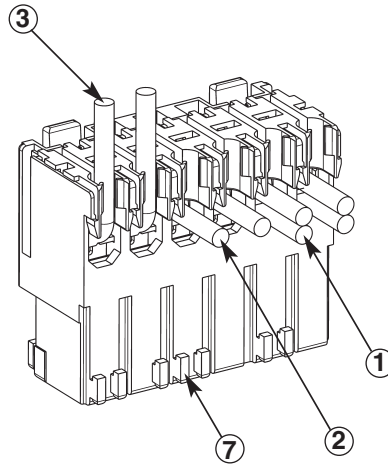

**Indirect Mating Connection  
with Interior Locking,  
5.0 mm Centerline**

- 1 Double Wire Exit
- 2 Wire Exit 90°
- 3 Wire Exit 180°
- 4 Cover
- 5 Interior Locking Latch
- 6 Keying
- 7 Polarisation

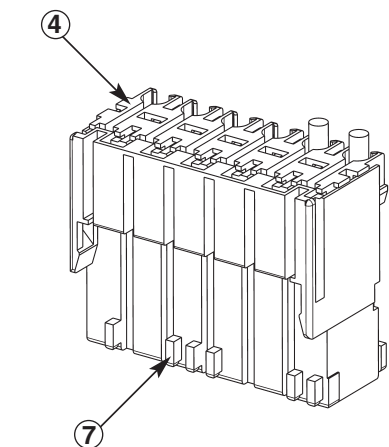
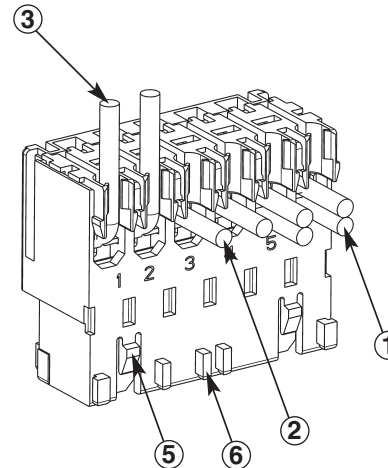

2

Rast 5

### Derating Curves

#### Direct Mating Connector System

**Connector:**  
8 positions

**Material:**  
Brass, tin plated

**Wire:**  
0.5 mm<sup>2</sup>

**PC Board:**  
FR4, 2 x 0.35 µm Copper,  
tin plated

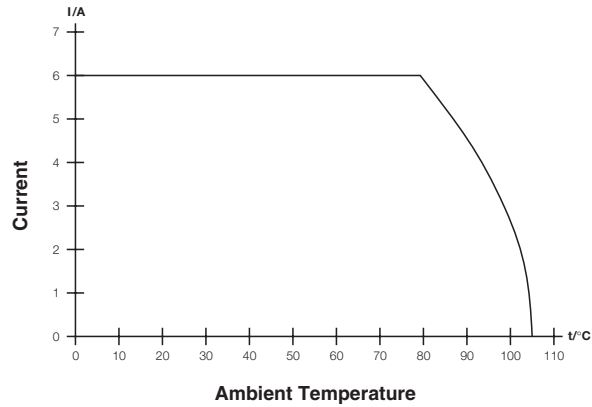

#### Indirect Mating Connector System

**Material:**  
Brass, tin plated

**Wire:**  
0.5 mm<sup>2</sup> (Curve 1 and 2)  
1.0 mm<sup>2</sup> (Curve 3)

**Mating Part:**  
6.3 x 0.8 mm Tab,  
Brass, tin plated

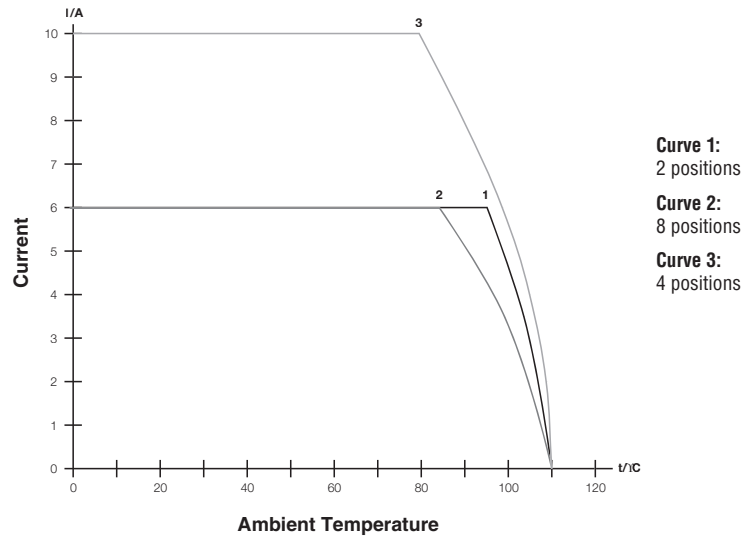

#### Indirect Mating Connector System

**Material:**  
CuNi2Si, silver plated

**Wire:**  
1.5 mm<sup>2</sup>, tin plated

**Mating Part:**  
6.3 x 0.8 mm Tab,  
Brass, tin plated

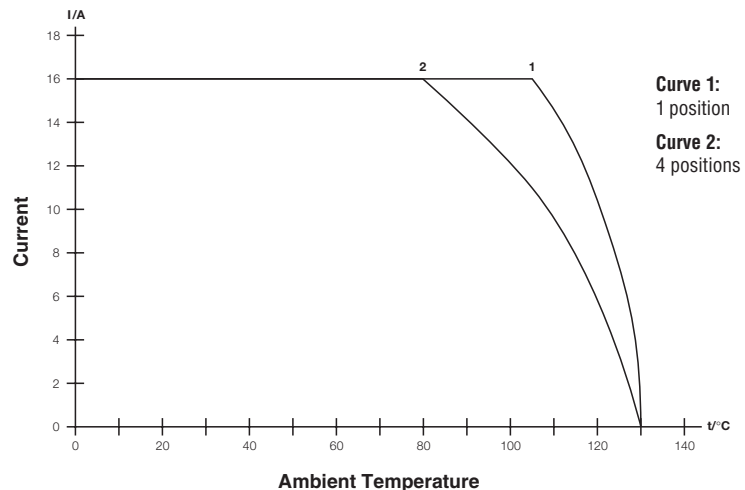

## Keying Plan and Cable Exit

### Keying Plan from Mating Direction, Fully-Keyed Version

- 1 Locking Latch
- 2 Keying Rib
- 3 Polarisisation Rib
- 4 Cavity Number

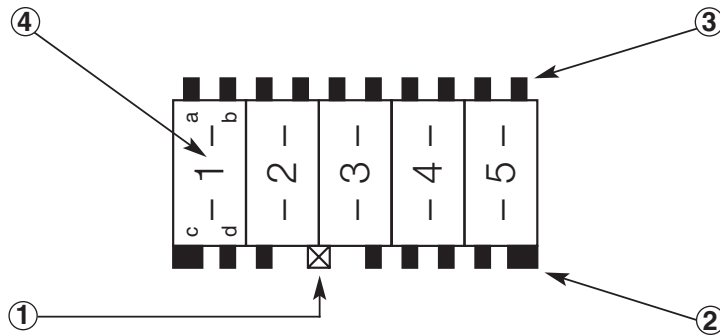

### Keyed Version: 05-C according RAST 5

This final keying version will be produced on the Application Tooling Equipment.

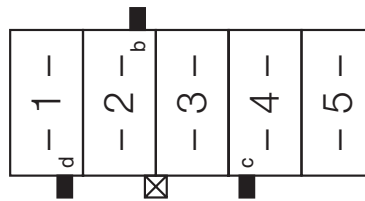

### Cable Exit with Interior and Exterior Locking

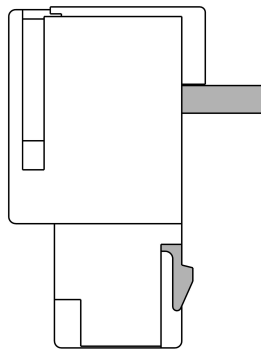

Cable Exit with Interior Locking

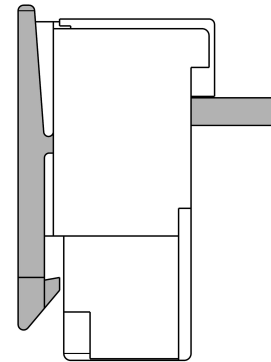

Cable Exit with Exterior Locking

### Direct Mating of a PCB with PC Board Frames

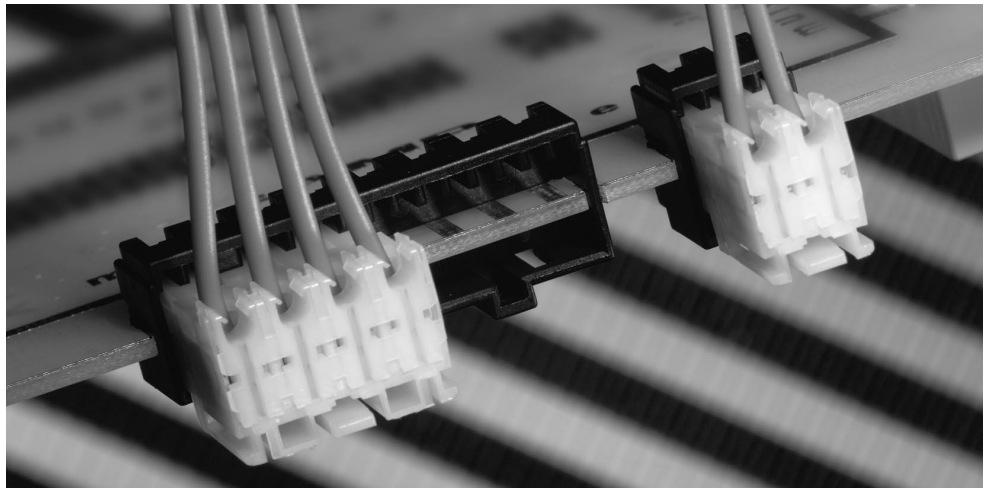

### Technical Features

#### Technical Data

**Centerline:**

5.0 mm

**Housing Material:**

Polyamide, PA 6.6 and PA 6

**Standard Colour:**

Natural

**Current Voltage:**

250 V ≈

**Air and Creepage Distance:**

>3.2 mm

**Flammability Rating:**

UL 94 V-2

**Approvals:**

VDE, UL

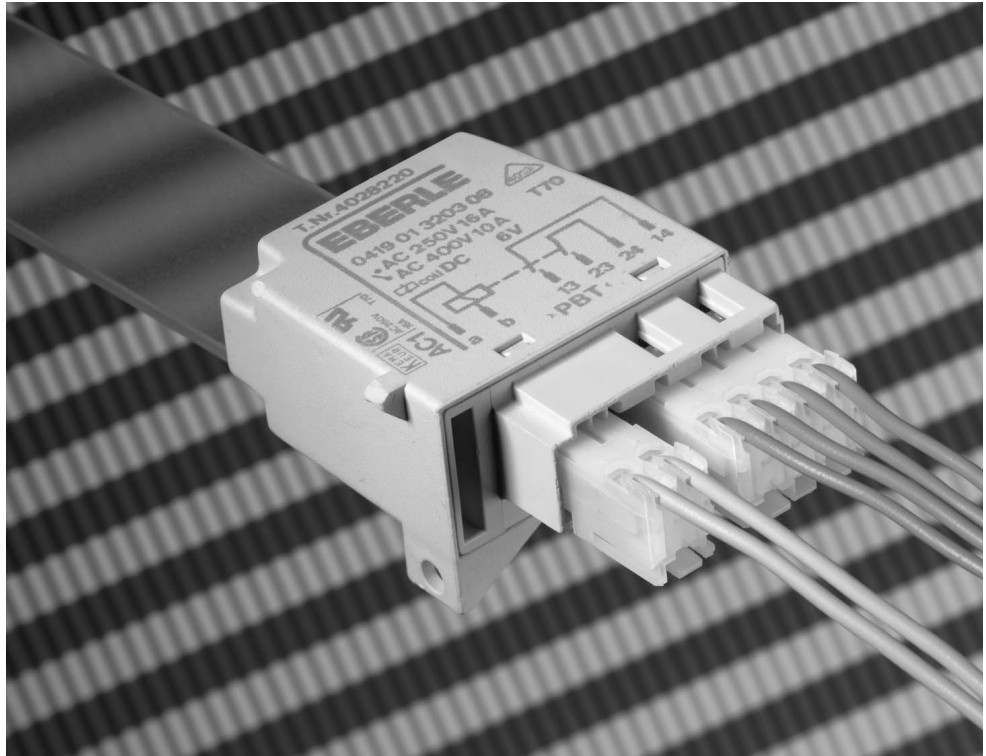

#### Direct Mating Connectors

**No. of Positions:**

2- to 8-positions

**Contact Material:**

Brass

**Contact Finish:**

Tin plated

**Wire Size Range:**

0.35–1.0 mm<sup>2</sup>

**Temperature Range:**

–40 °C up to +105 °C

**Current Rating:**

6 A max.

**Insulation Diameter:**

2.8 mm max.

**Insulation Resistance:**

>10 MΩ

**Mating Force:**

≤7 N per contact \*

**Unmating Force:**

≥1.5 N \*

**Product Specification:**

108-18653

**Application Specification:**

114-18289

\*) measured with polished steel plate 1.5 mm thickness

#### Indirect Mating Connectors

**No. of Positions:**

1- to 8-positions

**Contact Material:**

Brass / CuNi2Si

**Contact Finish:**

Tin plated / silver plated

**Wire Size Range:**

0.35–1.0 mm<sup>2</sup> / 1.0–1.5 mm<sup>2</sup>

**Temperature Range:**

–40 °C up to +130 °C

**Current Rating:**

10 A, up to 4 contacts 16 A

**Insulation Diameter:**

3.0 mm max.

**Insulation Resistance:**

>10 MΩ

**Mating Force:**

≤6.5 N per contact \*\*

**Unmating Force:**

≥1.5 N \*\*

**Product Specification:**

108-18652

**Application Specification:**

114-18288, 114-18382

\*\*) measured with polished steel tab 6.3 x 0.8 mm

### Direct Mating Connector System

#### Technical Data

**Wire Size Range:**  
0.35–1.0 mm<sup>2</sup>

**Current Carrying Capacity (max.):**  
6 A

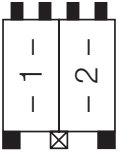
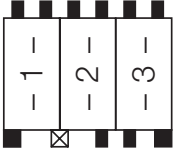
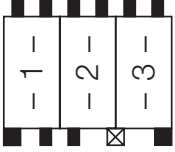
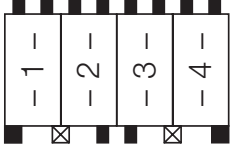
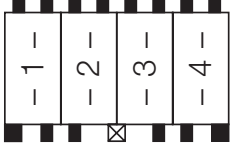
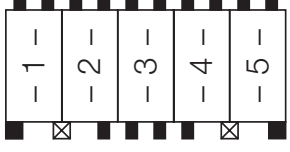
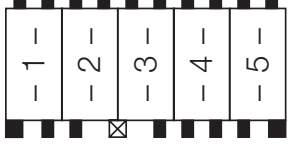
RAST 5 Version	Part Numbers with Exterior Locking		Package Quantity	Part Numbers with Interior Locking	
	PA 6.6	PA 6*		PA 6.6	PA 6*
	1241172-2	1534075-2	4,900	-	-
	1241172-3	1534075-3	3,136	-	-
	1-1241172-3	1-1534075-3	3,136	-	-
	1241172-4	1534075-4	2,352	-	-
	1-1241172-4	1-1534075-4	2,352	-	-
	1241172-5	1534075-5	1,960	-	-
	1-1241172-5	1-1534075-5	1,960	-	-

\*)According to IEC 60695-2-1/1; GWT (Glow Wire Test) 750 °C without flame, see VDE M-Test Report.  
The final keying version will be produced on the Application Tooling Equipment.

### Direct Mating Connector System (continued)

#### Technical Data

**Wire Size Range:**  
0.35–1.0 mm<sup>2</sup>

**Current Carrying Capacity (max.):**  
6 A

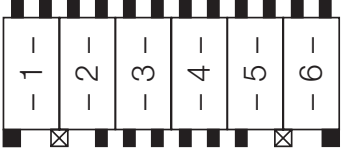
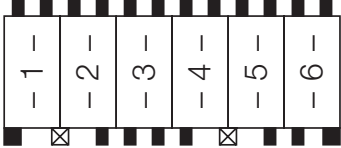
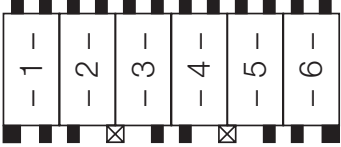
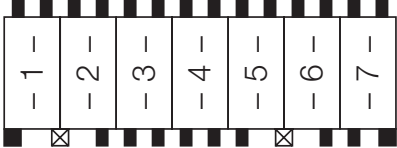
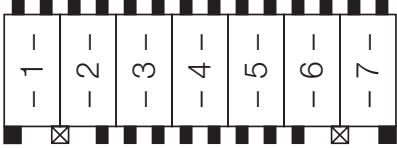
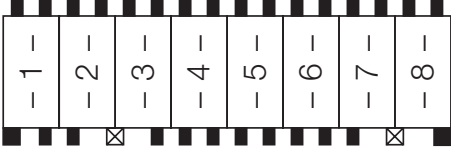
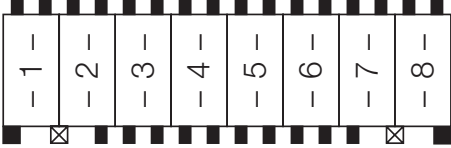
RAST 5 Version	Part Numbers with Exterior Locking		Package Quantity	Part Numbers with Interior Locking	
	PA 6.6	PA 6*		PA 6.6	PA 6*
	1241172-6	1534075-6	1,568	-	-
	1-1241172-6	1-1534075-6	1,568	-	-
	2-1241172-6	2-1534075-6	1,568	-	-
	1241172-7	1534075-7	1,372	-	-
	1-1241172-7	1-1534075-7	1,372	-	-
	1241172-8	1534075-8	1,176	-	-
	1-1241172-8	1-1534075-8	1,176	-	-

\*)According to IEC 60695-2-1/1; GWT (Glow Wire Test) 750 °C without flame, see VDE M-Test Report.  
The final keying version will be produced on the Application Tooling Equipment.



### Indirect Mating Connector System

#### Technical Data

Wire Size Range:  
0.35–1.0 mm<sup>2</sup>

Current Carrying Capacity  
(max.):  
10 A

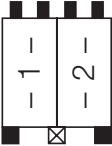
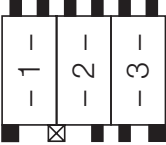
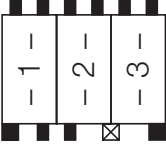
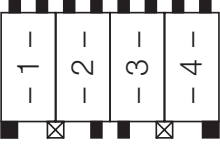
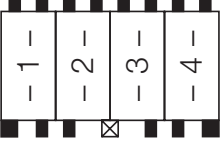
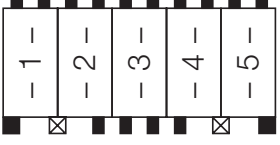
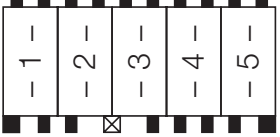
RAST 5 Version	Part Numbers with Exterior Locking		Package Quantity	Part Numbers with Interior Locking	
	PA 6.6	PA 6*		PA 6.6	PA 6*
	1241170-1	1534072-1	9,604	1241170-1	1534072-1
	1241170-2	1534072-2	4,900	1394355-2	1534077-2
	1241170-3	1534072-3	3,136	1394355-3	1534077-3
	1-1241170-3	1-1534072-3	3,136	1-1394355-3	1-1534077-3
	1241170-4	1534072-4	2,352	1394355-4	1534077-4
	1-1241170-4	1-1534072-4	2,352	1-1394355-4	1-1534077-4
	1241170-5	1534072-5	1,960	1394355-5	1534077-5
	1-1241170-5	1-1534072-5	1,960	1-1394355-5	1-1534077-5

\*)According to IEC 60695-2-1/1; GWT (Glow Wire Test) 750 °C without flame, see VDE M-Test Report.  
The final keying version will be produced on the Application Tooling Equipment.

### Indirect Mating Connector System (continued)

**Technical Data**
**Wire Size Range:**  
 0.35–1.0 mm<sup>2</sup>
**Current Carrying Capacity  
(max.):**  
 10 A

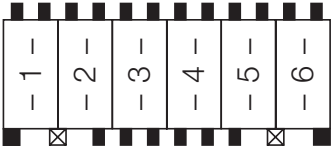
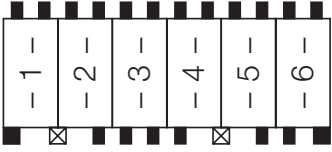
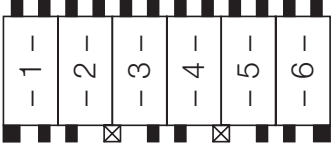
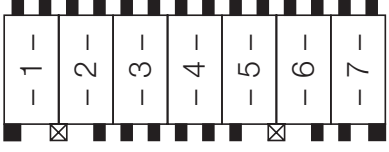
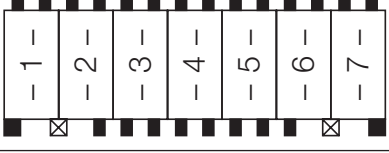
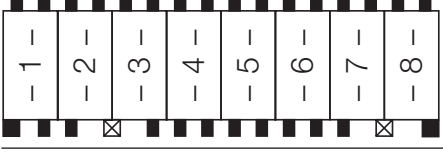
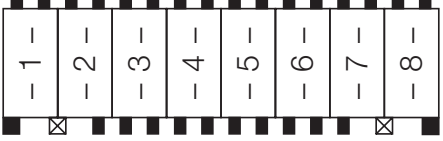
RAST 5 Version	Part Numbers with Exterior Locking		Package Quantity	Part Numbers with Interior Locking	
	PA 6.6	PA 6*		PA 6.6	PA 6*
	1241170-6	1534072-6	1,568	-	-
	1-1241170-6	1-1534072-6	1,568	-	-
	2-1241170-6	2-1534072-6	1,568	-	-
	1241170-7	1534072-7	1,372	-	-
	1-1241170-7	1-1534072-7	1,372	1394355-7	1534077-7
	1241170-8	1534072-8	1,176	-	-
	1-1241170-8	1-1534072-8	1,176	-	-

\*)According to IEC 60695-2-1/1; GWT (Glow Wire Test) 750 °C without flame, see VDE M-Test Report.  
 The final keying version will be produced on the Application Tooling Equipment.

### Indirect Mating Connector System (continued)

#### Technical Data

#### Wire Size Range:

1.0–1.5 mm<sup>2</sup>

#### Current Carrying Capacity (max.):

16 A

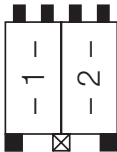
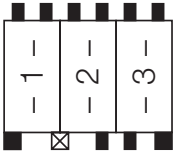
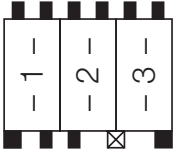
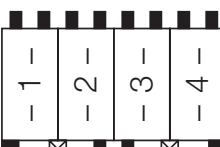
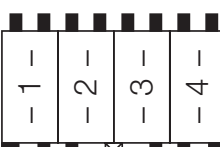
RAST 5 Version	Part Numbers with Exterior Locking		Package Quantity	Part Numbers with Interior Locking	
	PA 6.6	PA 6*		PA 6.6	PA 6*
	1241171-1	1534073-1	9,604	1241171-1	1534073-1
	1241171-2	1534073-2	4,900	1394556-2	1534078-2
	1241171-3	1534073-3	3,136	1394556-3	1534078-3
	1-1241171-3	1-1534073-3	3,136	1-1394556-3	1-1534078-3
	1241171-4	1534073-4	2,352	1394556-4	1534078-4
	1-1241171-4	1-1534073-4	2,352	1-1394556-4	1-1534078-4

\*)According to IEC 60695-2-1/1; GWT (Glow Wire Test) 750 °C without flame, see VDE M-Test Report.  
The final keying version will be produced on the Application Tooling Equipment.

### PC Board Frame

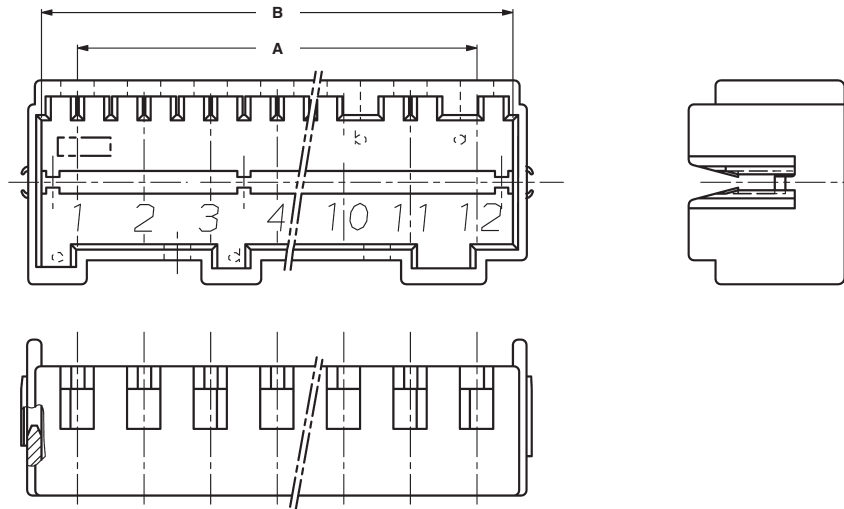
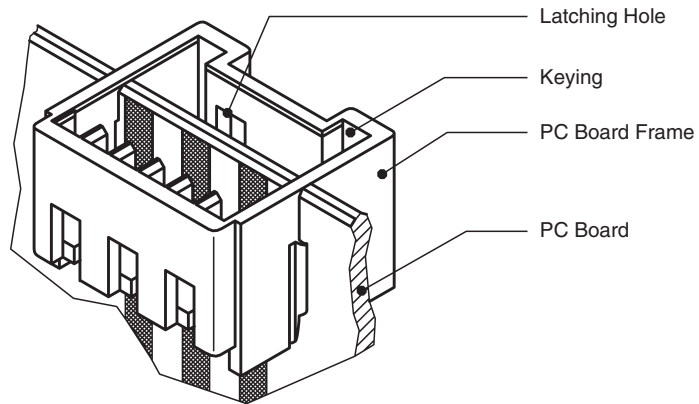

No. of Positions	Dimensions (mm)		Keying	Latching	Polarisation	Additional Board Lock	Part Number	Package Quantity
	A	B					PC Board Frame, PA 6.6, Black	
2	5	10.1	1c, 2d	1/2	-	-	<b>2-964577-2</b>	2,200
			1c, 2d, 3c	1/2, 3/4	2b	-	1-964577-4	
4	15	20.1	1c, 3c, 4d	1/2, 3/4	4b	-	2-964577-4	1,700
			1c, 3c, 4d	1/2, 3/4	1b, 4a	-	<b>3-964577-4</b>	
5	20	25.1	3d	1/2, 4/5	-	-	<b>1-964577-5</b>	1,500
6	25	30.1	4d	1/2, 5/6	6b	-	1-964577-6	1,500
			4d	1/2, 5/6	1b, 6a	-	<b>2-964577-6</b>	
7	30	35.1	2c, 3d, 7c	2/3, 5/6	1b, 2b	4/5	1-964577-7	1,200
			2c, 3d, 7c	2/3, 5/6	2b, 7a	4/5	<b>2-964577-7</b>	
8	35	40.1	2c, 3d, 7c	2/3, 7/8	2a	4/5	1-964577-8	1,000
			2c, 3d, 7c	2/3, 7/8	2b, 4b	4/5	<b>2-964577-8</b>	
12	55	60.1	1c, 2d, 3c, 4d, 5c, 8c, 10d, 12d	1/2, 3/4, 5/6, 8/9, 9/10, 11/12	2b, 3a, 4a, 6a, 7a, 7b, 8a, 8b	4/5, 8/9	1-964578-2	500

Preferred Parts are printed bold

### Introduction

#### AMP MONO-SHAPE Connectors in In-Line Mating Technology

AMP MONO-SHAPE connectors represent a valid solution to the ever-increasing requirements for production and application flexibility. They are high productivity, great flexibility, quality, minimum applied cost. AMP MONO-SHAPE product-line includes a full range of 5.0 mm pitch modular connectors contents with similar outer shape, several variation in the mating area such as PC Board and 6.3 x 0.8 mm tabs (RAST 5), plus a version for harness shunts.

AMP MONO-SHAPE connection system adopts the IDC termination technology, which improves application results and quality level.

The AMP MONO-SHAPE product range, combined with the performances and properties offered by the termination system, allow to manufacture extremely complicated harness structures while still maintaining high production levels.

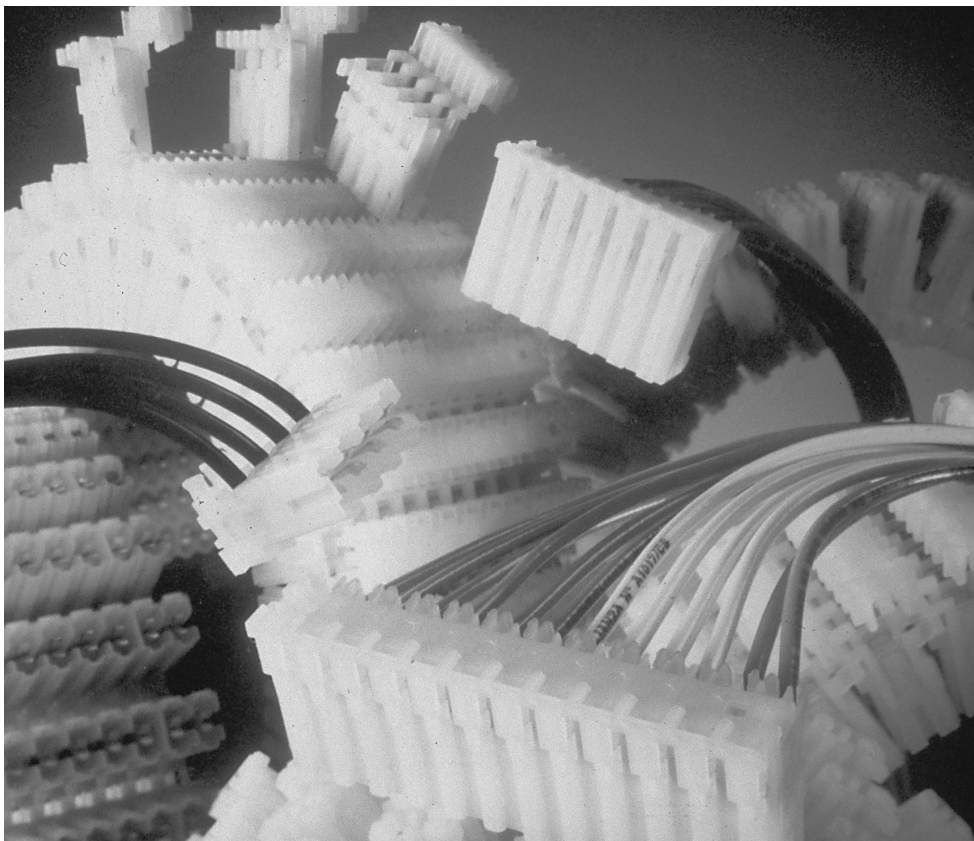

#### Technical Features

- IDC Connector system design to maximise the full integration with the application tooling assuring total flexibility in harness design.
- High current system, up to 16 Ampere, designed to satisfy several appliance requirements.
- ID Contact designed to accept standard discrete wires ranging from 0.5 up to 1.5 mm<sup>2</sup>, according to the connector configuration.
- The connector incorporates modern in-line mating technology on a 5.0 mm centerline with no loss of spacing and a variety of keying possibilities.
- Wiring faults eliminated through high automation.
- Approvals:  
VDE: 4751-1431-4024 / A  
10A and  
4751-1431-4024 / A 9E  
UL E 28476 Vol. 9 Sec. 7;  
97 ME 17936; AP-27HB

### AMP MONO-SHAPE Connector Versions

#### Same Shape - Different Applications

With the same outside shape four connector versions are available, which are to handle with the same application tooling.

#### TAB Connectors

2–12 position 5.0 mm pitch connectors with insulation displacement contacts mateable with components according to RAST 5 and with tinned copper alloy tab 6.3 x 0.8 mm according to DIN 46244.

**Wire Size Range:**  
0.5–1.5 mm<sup>2</sup>  
**Current Rating:**  
16 Ampere max. acc. to wire size  
  
-For LIF version up to  
10 Ampere max

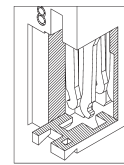
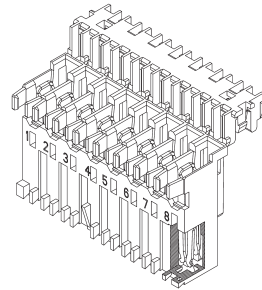

LIF version 2 point contact instead of 4 as per standard version

#### Single Way Connectors

Single Way connectors with insulation displacement contacts for use on tinned copper alloy tab 6.3 x 0.8 mm according to DIN 46244.

**Wire Size Range:**  
0.5–1.5 mm<sup>2</sup>  
**Current Rating:**  
16 Ampere max. acc. to wire size  
**Supply Status:**  
In order to increase productivity these items are supplied in sticks.

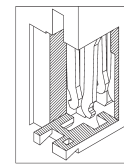
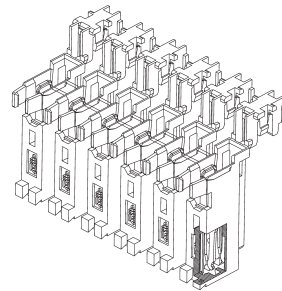

#### PCB Connectors

2–12 position 5.0 mm pitch connectors with insulation displacement contacts according to printed circuit boards with thickness 1.5±0.2 mm and 5.0 mm pitch.

**Wire Size Range:**  
0.5–0.75 mm<sup>2</sup>  
**Current Rating:**  
6 Ampere max. acc. to wire size  
**PC Board:**  
Single or both sides printed 5 µm tin over 35 µm copper

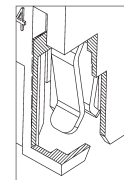
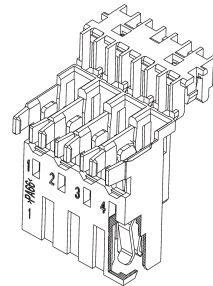

#### Satellite Connectors

3 position connectors, pitch 5.0 mm, with short circuited insulation displacement contacts for harness shunts.

**Wire Size Range:**  
0.5–1.5 mm<sup>2</sup>  
**Current Rating:**  
16 Ampère max. acc. to wire size

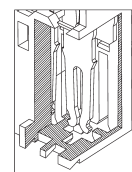
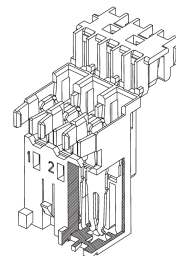

### TAB Connector

#### AMP MONO-SHAPE TAB Connector

- 1 Cover closed after Wire Insertion. Wire Direction 90°. 180° when locked in Cover Recess
- 2 Cavity Numbers
- 3 Polarisation similar to the Keying (Located on the Back Side)
- 4 Keying
- 5 Interior Locking Latch
- 6 Colour Marking

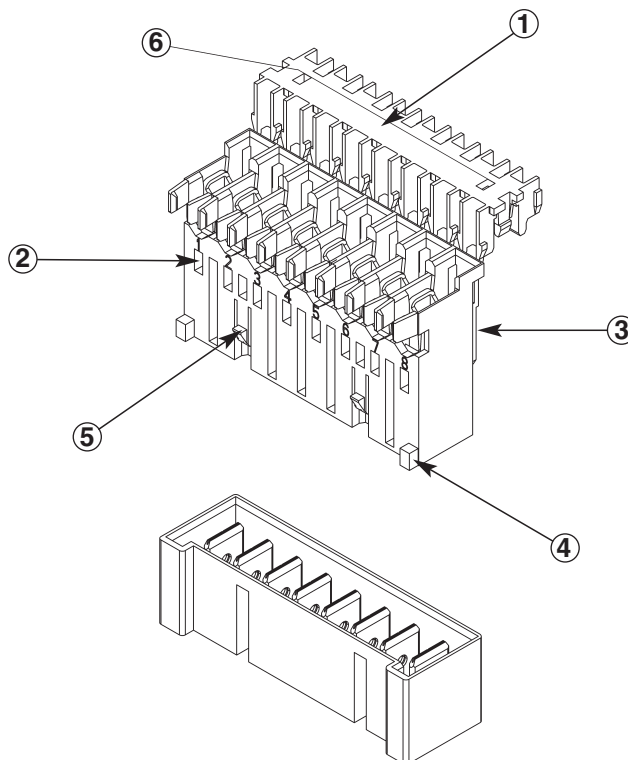

2

Rast 5

#### Technical Features

**Centerline:**  
5.0 mm, according to RAST 5 specifications

**Configurations:**  
2- to 12-positions

**Housing Material:**  
Plastic PA 6.6

**Housing Colour:**  
Natural colour for standard version  
Grey colour for LIF version

**Contact Material:**  
Copper alloy, post-tinned  
2.0 µm min.

**Polarisation, Keying, Locking Latches:**  
according to RAST 5 specifications  
(see customer drawings)

**Track Resistance:**  
as per IEC 112 (250 V)

**Glow Wire Test:**  
as per IEC 695-2-1 (850 °C)  
and 750°C no flame

**Air and Creepage Distance:**  
according to EN 60998-1  
(IEC 998-1) for 380 V, ≥4.0 mm

**Voltage Resistance:**  
according to EN 60998-1  
(IEC 998-1) 1750 V for 4 minutes

**Insulation Resistance:**  
according to EN 60998-1  
(IEC 998-1) >5 MΩ

**Wire Size Range:**  
from 0.5 to 1.5 mm<sup>2</sup>

**Current Rating:**  
**Standard Version**  
16 A max. according to wire size  
0.5 mm<sup>2</sup> ≤ 3 A, 0.75 mm<sup>2</sup> ≤ 6 A,  
1.0 mm<sup>2</sup> ≤ 10 A, 1.5 mm<sup>2</sup> ≤ 16 A

**LIF Version**  
10 A max. according to wire size  
0.5 mm<sup>2</sup> ≤ 3 A, 0.75 mm<sup>2</sup> ≤ 6 A,  
1.0 mm<sup>2</sup> ≤ 10 A, 1.5 mm<sup>2</sup> ≤ 10 A

**Rated Voltage:**  
380 Volts max.

**Wire Type:**  
**H05V-K** (70 °C max.)  
**or FR 3/2** (105 °C max.)  
for 0.5–1.0 mm<sup>2</sup> wires with  
copper or tinned stranded wires  
**H07V-K** (70 °C max.)

**or FR 3/2** (105 °C max.)  
for wires from 1.5 mm<sup>2</sup> with  
copper or tinned stranded wires

**Insulation Type:**  
PVC suitable for temperatures  
up to 70 °C / 105 °C

**Insulation Diameter Range:**  
2.0–3.5 mm

**Temperature Range:**  
–25 °C up to +105 °C

**Wire Extraction Force/Way:**  
50 N min. on wire size 0.5 mm<sup>2</sup>

**Application Specification:**  
114-20016

**Product Specification:**  
**Standard version:** 108-20065  
**LIF version:** 108-20215

**Homologations:**  
acc.to VDE File No. 3905  
(to 16 A) and UL File No.  
E28476 (to 14 A)

### Keying Plan

#### Keying Plan from Mating Direction,

- 1 Locking Latch
- 2 Slanted Keying Rib
- 3 Keying Rib
- 4 Polarisation Rib
- 5 Cavity Number

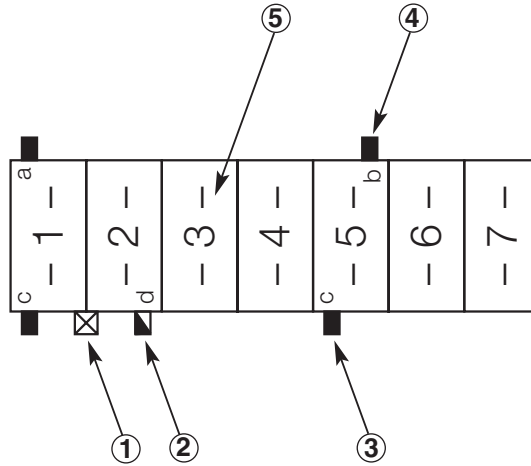

#### AMP MONO-SHAPE TAB Connector

#### 2 Position RAST 5 Variations (Variable Keying)\*

Suitable for RAST 5 Version Colour Marking	RAST 5 Version	Part Numbers			Packaging Unit		
		On Tray	Loose Piece	On Reel	On Reel	Loose Piece	On Reel
02-B 02-E 02-F Grey		1-282002-2 <b>1-284338-2</b>	2-282002-2 <b>2-284338-2</b>	3-282002-2 —	6.500	3.500	28.500
02-C Black		1-282002-1 <b>1-284338-1</b>	2-282002-1 <b>2-284338-1</b>	2-282002-1 —	6.500	3.500	28.500
02-L 02-P Red		1-282002-3 <b>1-284338-3</b>	2-282002-3 <b>2-284338-3</b>	— <b>3-284338-3</b>	6.500	3.500	28.500
02-A 02-O Blue		1-282002-4 <b>1-284338-4</b>	2-282002-4 —	— —	6.500	3.500	—
02-Q Black		1-282002-5	2-282002-5	—	6.500	3.500	—
— Black		1-282002-6	2-282002-6	—	6.500	3.500	—
— —		1-282002-7 <b>1-284338-7</b>	2-282002-7 —	3-282002-7 —	6.500	3.500	28.500

\* Final keying version is produced on the Application Tooling Machines.

**Bold Part Numbers are LIF Version**



### AMP MONO-SHAPE TAB Connector

#### 3 Position RAST 5 Variations (Variable Keying)\*

Suitable for RAST 5 Version Colour Marking	RAST 5 Version	Part Numbers			Packaging Unit		
		On Tray	Loose Piece	On Reel	On Reel	Loose Piece	On Reel
03-A 03-I Orange		1-282003-1 <b>1-284339-1</b>	2-282003-1 <b>2-284339-1</b>	3-282003-1 —	4.160	2.500	24.000
03-B 03-K Blue		1-282003-2 <b>1-284339-2</b>	2-282003-2 <b>2-284339-2</b>	3-282003-2 —	4.160	2.500	24.000
03-F Green		1-282003-3 <b>1-284339-3</b>	2-282003-3 <b>2-284339-3</b>	— —	4.160	2.500	—
03-D —		282233-2	282233-2	—	4.160	2.500	—
03-B 03-K Red		1-282003-4 <b>1-284339-4</b>	2-282003-4 <b>2-284339-4</b>	— —	4.160	2.500	—
03-B 03-K Grey		1-282003-5 <b>1-284339-5</b>	2-282003-5 <b>2-284339-5</b>	— —	4.160	2.500	—
— Violet		1-282003-6	2-282003-6	—	4.160	2.500	—
03-B Black		1-282003-7	—	—	4.160	—	—
— Black		1-284396-1	—	—	4.160	—	—

\* Final keying version is produced on the Application Tooling Machines.  
**Bold Part Numbers are LIF Version**

2  
Rast 5

### AMP MONO-SHAPE TAB Connector

#### 4 Position RAST 5 Variations (Variable Keying)\*

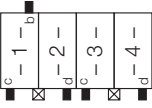
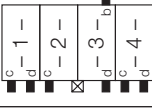
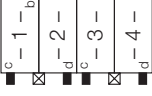
Suitable for RAST 5 Version Colour Marking	RAST 5 Version	Part Numbers			Packaging Unit		
		On Tray	Loose Piece	On Reel	On Reel	Loose Piece	On Reel
04-A Grey		1-282004-1	2-282004-1	3-282004-1	2.120	2.000	18.750
04-D Black		1-282004-2	2-282004-2	3-282004-2	2.120	2.000	18.750
04-A Red		1-282004-3	2-282004-3	—	2.120	2.000	—

#### 5 Position RAST 5 Variations (Variable Keying)\*

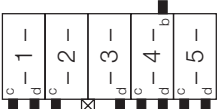
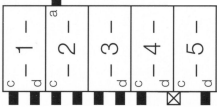
Suitable for RAST 5 Version Colour Marking	RAST 5 Version	Part Numbers			Packaging Unit		
		On Tray	Loose Piece	On Reel	On Reel	Loose Piece	On Reel
Red		1-282005-1	2-282005-1	—	2.600	1.500	18.750
Red		1-284545-1	—	—	2.600	1.500	18.750

\* Final keying version is produced on the Application Tooling Machines.

### AMP MONO-SHAPE TAB Connector

#### 6 Position RAST 5 Variations (Variable Keying)\*

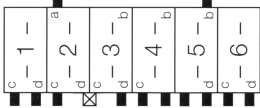
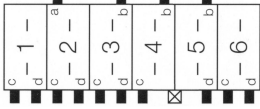
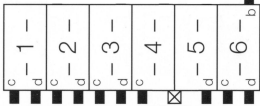
Suitable for RAST 5 Version Colour Marking	RAST 5 Version	Part Numbers			Packaging Unit		
		On Tray	Loose Piece	On Reel	On Reel	Loose Piece	On Reel
Violet		1-282006-1	2-282006-2	3-282006-2	2.080	1.200	13.500
—		1-282006-3	2-282006-3	3-282006-3	2.080	1.200	13.500
Red		1-284745-1	—	—	2.080	—	—

#### 7 Position RAST 5 Variations (Variable Keying)\*

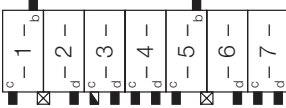
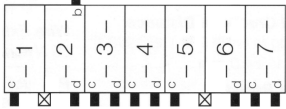
Suitable for RAST 5 Version Colour Marking	RAST 5 Version	Part Numbers			Packaging Unit		
		On Tray	Loose Piece	On Reel	On Reel	Loose Piece	On Reel
—		1-282007-1	2-282007-1	—	1.820	1.200	—
Black		1-284397-1	—	—	1.820	1.200	—

2  
Rast 5

### AMP MONO-SHAPE TAB Connector

#### 8 Position RAST 5 Variations (Variable Keying)\*

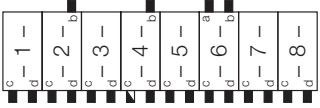
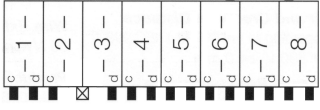
Suitable for RAST 5 Version Colour Marking	RAST 5 Version	Part Numbers			Packaging Unit		
		On Tray	Loose Piece	On Reel	On Reel	Loose Piece	On Reel
—		284085-1 <b>1-284685-1</b>	2-284085-1 <b>2-284685-1</b>	— —	1.560	900	—
Violet		284085-2	2-284085-2	—	1.560	900	—

\* Final keying version is produced on the Application Tooling Machines.  
**Bold Part Numbers are LIF Version**

#### 10 Position RAST 5 Variations (Variable Keying)\*

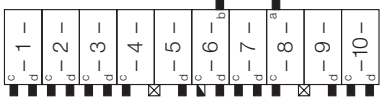
Suitable for RAST 5 Version Colour Marking	RAST 5 Version	Part Numbers			Packaging Unit		
		On Tray	Loose Piece	On Reel	On Reel	Loose Piece	On Reel
—		1-282010-1 <b>1-284686-1</b>	2-282010-1 <b>2-284686-1</b>	— —	1.300	700	—

\* Final keying version is produced on the Application Tooling Machines.  
**Bold Part Numbers are LIF Version**

### AMP MONO-SHAPE Single Way Connector

#### Single Way Connector

- 1 All Single Way Connectors are supplied in "stick-form" by 6 single ways each. They will be cut from the Application Tooling Machines
- 2 Cover closed after Wire Insertion. Wire Direction 90°. 180° when locked in Cover Recess
- 3 Polarisation similar to the keying of the front side
- 4 Keying
- 5 Plastic Noses which Lock into the TAB Hole
- 6 Colour Marking

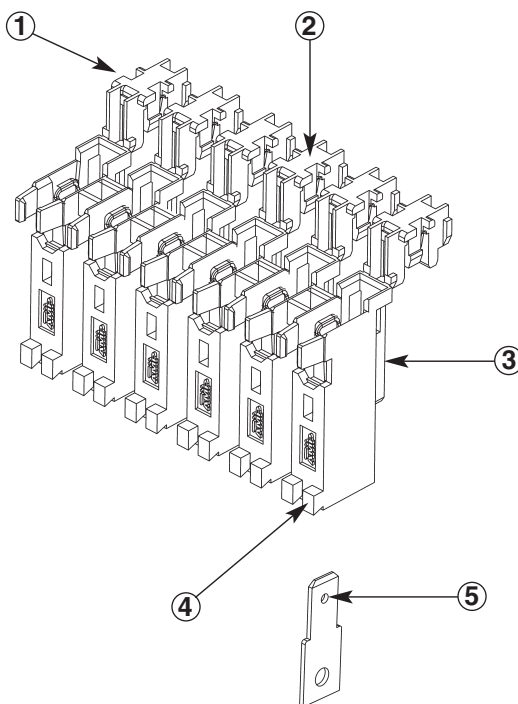

2

Rast 5

#### Technical Features

**Centerline:**  
5.0 mm, according to RAST 5 specifications

**Configurations:**  
1 position

**Housing Material:**  
Plastic PA 6.6

**Housing Colour:**  
Natural colour

**Contact Material:**  
Copper alloy, post-tinned  
2.0 µm min.

**Polarisation, Keying, Locking Latches:**  
according to RAST 5 specifications  
(see customer drawings)

**Track Resistance:**  
as per IEC 112 (250 V)

**Glow Wire Test:**  
as per IEC 695-2-1 (850 °C)  
and 750°C no flame

**Air and Creepage Distance:**  
according to EN 60998-1  
(IEC 998-1) for 380 V, ≥4.0 mm

**Voltage Resistance:**  
according to EN 60998-1  
(IEC 998-1) 1750 V for 4 minutes

**Insulation Resistance:**  
according to EN 60998-1  
(IEC 998-1) >5 MΩ

**Wire Size Range:**  
from 0.5 to 1.5 mm<sup>2</sup>

**Current Rating:**  
16 A max. according to wire size  
0.5 mm<sup>2</sup> ≤3 A, 0.75 mm<sup>2</sup> ≤6 A,  
1.0 mm<sup>2</sup> ≤10 A, 1.5 mm<sup>2</sup> ≤16 A

**Rated Voltage:**  
380 Volts max.

**Wire Type:**  
**H05V-K** (70 °C max.)  
**or FR 3/2** (105 °C max.)  
for 0.5–1.0 mm<sup>2</sup> wires with  
copper or tinned stranded wires  
**H07V-K** (70 °C max.)  
**or FR 3/2** (105 °C max.)  
for wires from 1.5mm<sup>2</sup> with  
copper or tinned stranded wires

**Insulation Type:**  
PVC suitable for temperatures  
up to 70 °C / 105 °C

**Insulation Diameter Range:**  
2.0–3.5 mm

**Temperature Range:**  
–25 °C up to +105 °C

**Wire Extraction Force/Way:**  
50 N min. on wire size 0.5 mm<sup>2</sup>

**Application Specification:**  
114-20017

**Product Specification:**  
108-20066

**Homologations:**  
acc.to VDE File No. 3905  
(to 16 A) and UL File No.  
E28476 (to 14 A)

**Counter Part:**  
Tab 6.3 x 0.8 mm  
as per DIN 46244 norms

**Materials:**  
Copper alloy

**Finishing:**  
Tinned (6.0 µm max.)

### Keying Plan from Mating Direction

#### Keying Plan

- 1 Keying Rib
- 2 Polarisation Rib
- 3 Cavity Number

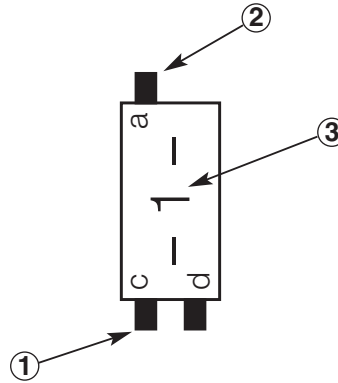

### AMP MONO-SHAPE Single Way Connector

#### 1 Position (Variable Keying)\*

Suitable for RAST 5 Version Colour Marking	RAST 5 Version	Part Numbers		Packaging Unit	
		On Tray	On Reel	On Tray	On Reel
—		—	1-282086-1	1.024	10.500
Black		—	1-282086-2	1.024	—
Orange		—	1-282086-3	1.024	—
Green		—	1-282086-4	1.024	—
Blue		—	1-282086-5	1.024	—
Violet		—	1-282086-6	1.024	—

## AMP MONO-SHAPE PCB (Printed Circuit Board) Connector

### PCB Connector

- 1 Cover closed after Wire Insertion.  
Wire Direction 90°. 180° when locked in Cover Recess
- 2 Cavity Numbers
- 3 Keying Slot in PC Board
- 4 Locking Hole in PC Board
- 5 Colour Marking

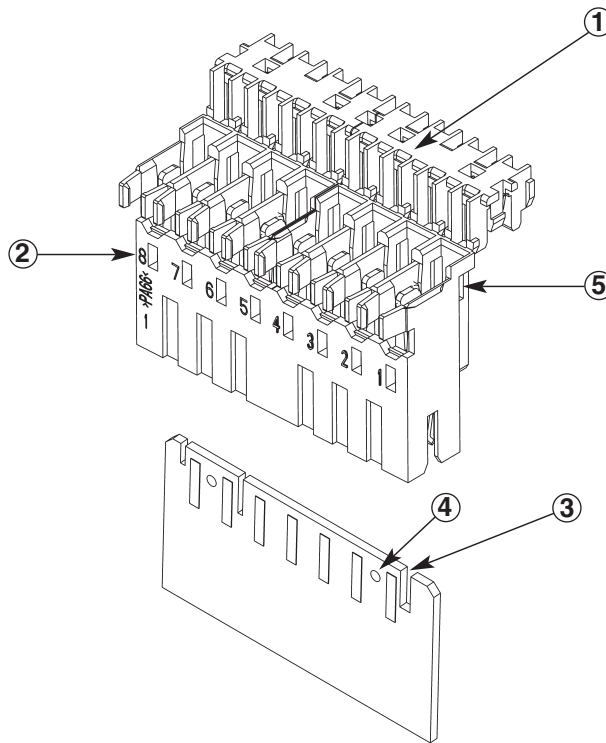

2

Rast 5

### Technical Features

**Centerline:**  
5.0 mm

**Configurations:**  
2-12 positions

**Housing Material:**  
Plastic PA 6.6

**Housing Colour:**  
Natural colour

**Contact Material:**  
Copper alloy, post-tinned  
2.0 µm min.

**Polarisation, Keying, Locking Latches:**  
according to RAST 5 specifications  
(see customer drawings)

**Track Resistance:**  
as per IEC 112 (250 V)

**Glow Wire Test:**  
as per IEC 695-2-1 (850 °C)  
and 750°C no flame

**Air and Creepage Distance:**  
according to EN 60998-1  
(IEC 998-1) for 240 V, ≥3.0 mm

**Voltage Resistance:**  
according to EN 60998-1  
(IEC 998-1) 1750 V for 4 minutes

**Insulation Resistance:**  
according to EN 60998-1  
(IEC 998-1) >5 MΩ

**Wire Size Range:**  
from 0.5 to 0.75 mm<sup>2</sup>

**Current Rating:**  
6 A max. according to wire size  
0.5 mm<sup>2</sup> ≤3 A, 0.75 mm<sup>2</sup> ≤6 A

**Rated Voltage:**  
220 Volts max.

**Wire Type:**  
**H05V-K** (70 °C max.)  
**or FR 3/2** (105 °C max.)  
for 0.5–1.0 mm<sup>2</sup> wires with  
copper or tinned stranded wires  
**H07V-K** (70 °C max.)  
**or FR 3/2** (105 °C max.)  
for wires from 1.5mm<sup>2</sup> with  
copper or tinned stranded wires

**Insulation Type:**  
PVC suitable for temperatures  
up to 70 °C / 105 °C

**Insulation Diameter Range:**  
2.0–2.8 mm

**Temperature Range:**  
–25 °C up to +105 °C

**Wire Extraction Force/Way:**  
50 N min. on wire size 0.5 mm<sup>2</sup>

**Application Specification:**  
114-20025

**Product Specification:**  
108-20067

**Homologations:**  
acc.to VDE File No. 3905  
(to 6 A) and UL File No. E28476  
(to 6 A)

**Printed Circuit Board:**  
Thickness 1.5±0.2mm

**Tinned Circuit Paths:**  
5.0mm pitch and width of  
1.8mm

## AMP MONO-SHAPE PCB (Printed Circuit Board) Connector

### PCB Connector

- 1 PC Board
- 2 First Circuit Path
- 3 MONO-SHAPE Connector
- 4 Wire

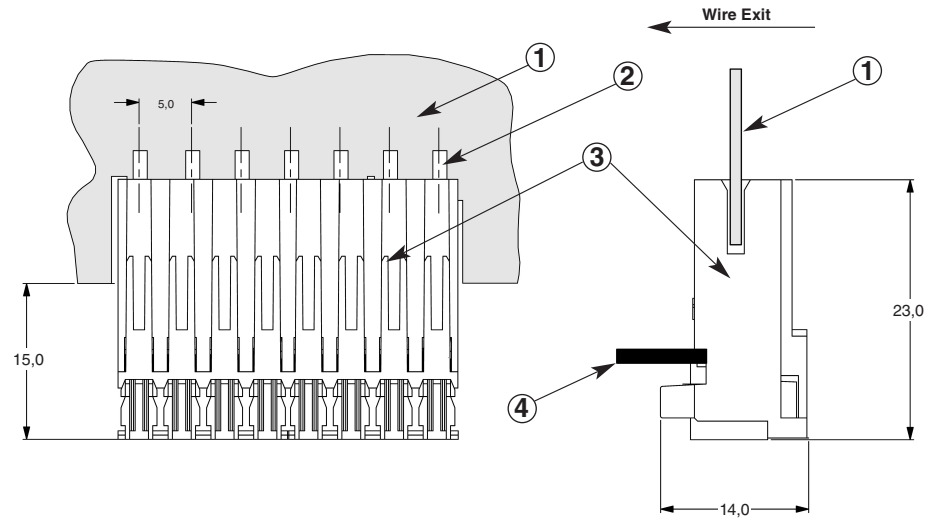

### Notes Concerning the PC Board Layout

- 1 First circuit path
- 2 Slot for keying rib in front of first cavity (according to the connector 4.0 mm or 7.4 mm)
- 3 Bore hole for locking clip symmetric between two cavities (diameter 2.5 mm)
- 4 Slot for keying rib symmetric between two cavities

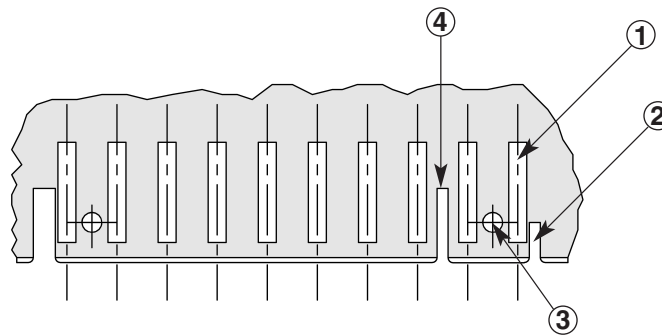

### PC Board Layout Dimensions on request.

See Customer Drawing 282042





### AMP MONO-SHAPE PCB (Printed Circuit Board) Connector

#### Centerline 5.0 mm

No. of Positions Colour Marking	PC Board Cut-Out	Part Numbers			Packaging Unit		
		On Tray	Loose Piece	On Reel	On Reel	Loose Piece	On Reel
2 Brown		1-282042-1	2-282042-1	—	5.980	3.500	—
2 Green		1-282042-2	2-282042-2	3-282042-2	5.980	3.500	28.500
2 Blue		1-282042-3	2-282042-3	3-282042-3	5.980	3.500	28.500
2 Red		1-282042-4	2-282042-4	—	5.980	3.500	—
2 Black		1-282042-5	2-282042-5	3-282042-5	5.980	3.500	28.500
3 —		1-282043-2	2-282043-2	3-282043-2	4.160	2.500	24.000
3 Black		1-282043-3	2-282043-3	—	4.160	2.500	—
3 —		282235-2	2-282235-2	—	4.160	2.500	—
3 Black		282235-3	2-282235-3	—	4.160	2.500	—
3 Blue		1-1284546-1	—	—	4.160	—	—
4 —		1-282044-1	2-282044-1	3-282044-1	3.120	2.000	18.750

### AMP MONO-SHAPE PCB (Printed Circuit Board) Connector

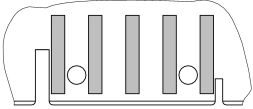
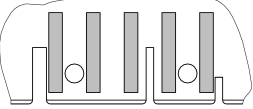
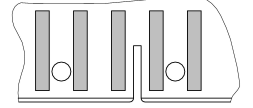
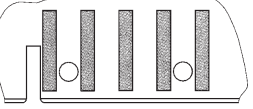
#### Centerline 5.0 mm (continued)

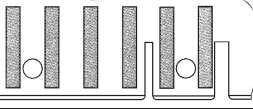
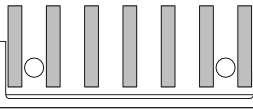
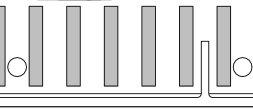
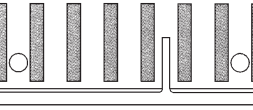
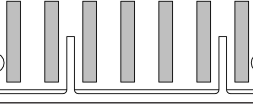
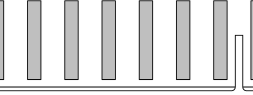
No. of Positions Colour Marking	PC Board Cut-Out	Part Numbers			Packaging Unit		
		On Tray	Loose Piece	On Reel	On Reel	Loose Piece	On Reel
5 —		1-282045-1	2-282045-1	3-282045-1	2.600	1.500	18.750
5 Green		1-282045-2	2-282045-2	3-282045-2	2.600	1.500	18.750
5 —		1-282045-3	2-282045-3	3-282045-3	2.600	1.500	18.750
5 —		1-284733-1	2-284733-1	3-284733-1	2.600	1.500	18.750
6 —		1-282046-1	2-282046-1	3-282046-1	2.080	1.200	13.500
6 —		1-284734-1	2-284734-1	3-284734-1	2.080	1.200	13.500
7 —		1-282047-1	2-282047-1	3-282047-1	1.820	1.200	13.500
8 —		284208-1	2-284208-1	—	1.560	900	—
8 —		284574-1	—	—	1.560	—	—
9 —		1-282049-1	2-282049-1	3-282049-1	1.300	700	10.500
10 —		1-282050-1	2-282050-1	3-282050-1	1.300	700	10.500

### AMP MONO-SHAPE PCB (Printed Circuit Board) Connector

#### Centerline 5.0 mm (continued)

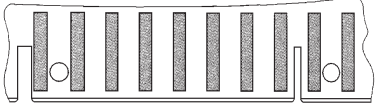
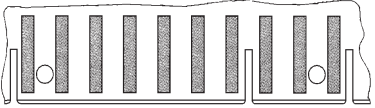
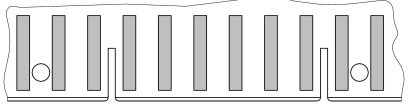
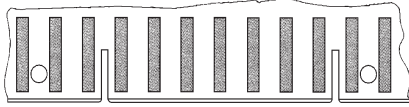
No. of Positions Colour Marking	PC Board Cut-Out	Part Numbers			Packaging Unit		
		On Tray	Loose Piece	On Reel	On Reel	Loose Piece	On Reel
10 Black		1-284401-1	—	—	1.300	—	—
10 —		284575-1	—	—	1.300	—	—
11 —		1-282051-1	2-282051-1	3-282051-1	1.040	700	10.500
12 —		1-282052-1	2-282052-1	3-282052-1	1.040	700	10.500

2

Part 5

### AMP MONO-SHAPE Satellite Connector

#### Satellite Connector

- 1 Cover closed after Wire Insertion. Wire Direction 90°. 180° when locked in Cover Recess
- 2 Bridge between Contacts to have Short Circuit
- 3 Cavity Numbers
- 4 For Satellite version, the cavity 1 only accept TAB contact, other cavities are clogged

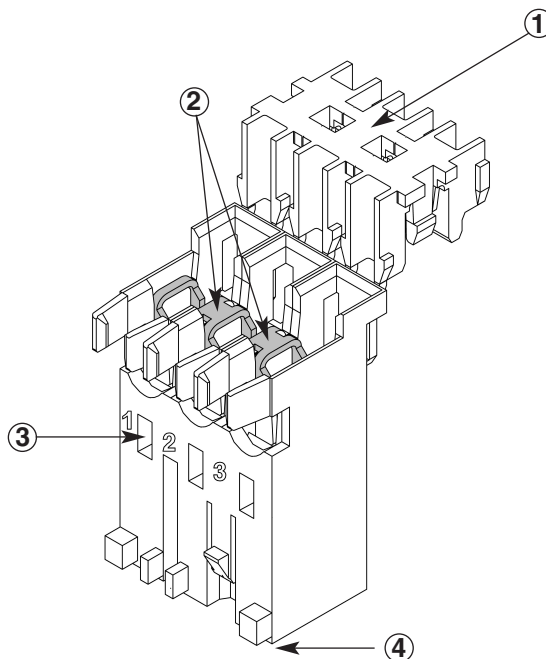

#### Technical Features

**Centerline:**

5.0 mm, according to RAST 5 specifications

**Configurations:**

3 positions only (for special version please contact Tyco Electronics)

**Housing Material:**

Plastic PA 6.6

**Housing Colour:**

Natural colour

**Contact Material:**

Copper alloy, post-tinned  
2.0 µm min.

**Polarisation, Keying,**

**Locking Latches:**

according to RAST 5 specifications  
(see customer drawings)

**Track Resistance:**

as per IEC 112 (250 V)

**Glow Wire Test:**

as per IEC 695-2-1 (850 °C)  
and 750°C no flame

**Air and Creepage Distance:**

according to EN 60998-1  
(IEC 998-1) for 380 V, ≥4.0 mm

**Voltage Resistance:**

according to EN 60998-1  
(IEC 998-1) 1750 V for 4 minutes

**Insulation Resistance:**

according to EN 60998-1  
(IEC 998-1) >5 MΩ

**Wire Size Range:**

from 0.5 to 1.5 mm<sup>2</sup>

**Current Rating:**

16 A max. according to wire size  
0.5 mm<sup>2</sup> ≤3 A, 0.75 mm<sup>2</sup> ≤6 A,  
1.0 mm<sup>2</sup> ≤10 A, 1.5 mm<sup>2</sup> ≤16 A

**Rated Voltage:**

380 Volts max.

**Wire Type:**

**H05V-K** (70 °C max.)  
**or FR 3/2** (105 °C max.)  
for 0.5–1.0 mm<sup>2</sup> wires with  
copper or tinned stranded wires

**H07V-K** (70 °C max.)

**or FR 3/2** (105 °C max.)

for wires from 1.5mm<sup>2</sup> with  
copper or tinned stranded wires

**Insulation Type:**

PVC suitable for temperatures  
up to 70 °C / 105 °C

**Insulation Diameter Range:**

2.0–3.5 mm

**Temperature Range:**

–25 °C up to +105 °C

**Wire Extraction Force/Way:**

50 N min. on wire size 0.5 mm<sup>2</sup>

**Application Specification:**

114-20026

**Product Specification:**

108-20070

**Homologations:**

acc.to VDE File No. 3905  
(to 16 A) and UL File No.  
E28476 (to 14 A)

### Keying Plan from Mating Direction

#### Keying Plan

- 1 Locking Latch
- 2 Keying Rib
- 3 Polarisation Rib
- 4 Cavity Number

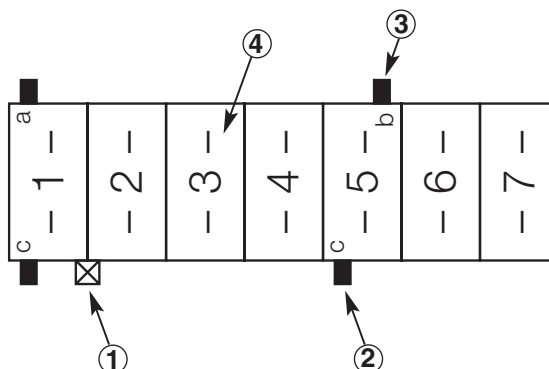

#### AMP MONO-SHAPE - 3 Position Satellite Connector (Variable Keying)\*

Suitable for RAST 5 Version Colour Marking	RAST 5 Version	Part Numbers			Packaging Unit		
		On Tray	Loose Piece	On Reel	On Reel	Loose Piece	On Reel
03-A 03-I Black		1-282099-1	—	—	4.160	—	—

#### AMP MONO-SHAPE - 2 Position Satellite Connector

(Variable Keying)\* Bridge between Contacts. Cavity Numbers 1-2 to have Short Circuit

02-L 02-P —		1-284288-1	284288-1	—	6.500	—	—
02-L 02-P Orange		—	284288-2	—	—	3.000	—
02-L 02-P Blue		1-284288-3	284288-3	—	6.500	3.000	—
02-L 02-P Green		—	284288-4	—	—	3.000	—
02-L 02-P Violet		—	284288-5	—	—	3.000	—
02-L 02-P Black		1-284288-6	284288-6	—	6.500	3.000	—
02-C —		—	284288-7	—	—	3.000	—

\* Final keying version is produced on the Application Tooling Machines.

### Keying Plan from Mating Direction

#### AMP MONO-SHAPE Bridge Connector - 3 Position RAST 5 Variation

(Variable Keying)\* Bridge between Contacts. Cavity Numbers 1-2-3 to have Short Circuit

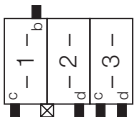
Suitable for RAST 5 Version Colour Marking	RAST 5 Version	Part Numbers			Packaging Unit		
		On Tray	Loose Piece	On Reel	On Reel	Loose Piece	On Reel
03-A 03-l  Green		—	284289-1	—	—	2.500	—

#### AMP MONO-SHAPE Bridge Connector - 6 Position RAST 5 Variation

(Variable Keying)\* Bridge between Contacts. Cavity Numbers 1-2-3 to have Short Circuit

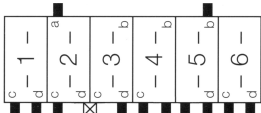
Suitable for RAST 5 Version Colour Marking	RAST 5 Version	Part Numbers			Packaging Unit		
		On Tray	Loose Piece	On Reel	On Reel	Loose Piece	On Reel
—  Green		—	284290-1	—	—	1.200	—

#### AMP MONO-SHAPE Bridge Connector - 6 Position RAST 5 Variation

(Variable Keying)\* Bridge between Contacts. Cavity Numbers 1-2 and 3-4 to have Short Circuit

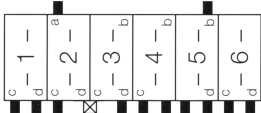
Suitable for RAST 5 Version Colour Marking	RAST 5 Version	Part Numbers			Packaging Unit		
		On Tray	Loose Piece	On Reel	On Reel	Loose Piece	On Reel
—  Black		—	284290-2	—	—	1.200	—

#### AMP MONO-SHAPE Bridge Connector - 6 Position RAST 5 Variation

(Variable Keying)\* Bridge between Contacts. Cavity Numbers 1-2-3-4-5-6 to have Short Circuit

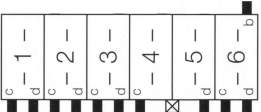
Suitable for RAST 5 Version Colour Marking	RAST 5 Version	Part Numbers			Packaging Unit		
		On Tray	Loose Piece	On Reel	On Reel	Loose Piece	On Reel
—  —		1-284744-1	—	—	2.080	—	—

\* Final keying version is produced on the Application Tooling Machines.

### Introduction

#### AMP MONO-SHAPE MARK II Connectors in In-Line Mating Technology

MONO-SHAPE Mark II Connector System was developed according to the newest level of knowledge and standard.

The requirements of advanced In-Line mating technology for the component and contact of printed circuit board (PCB) is granted by the two versions TAB and PCB connector systems.

System is designed to maximise the full integration with the application tooling, assuring the flexibility in the harness design.

This system is suitable for a wide wire size range of conductor and current carrying capacity up to 16 A.

Double termination is possible with 0.5 and 0.5mm<sup>2</sup> or 0.5 and 0.75mm<sup>2</sup> conductors. (See application spec. 114-20104 for details)

The connectors are available in 1 to 10 positions (TAB Version) with interior locking device and 2 to 12 positions (PCB Version)

Connectors are supplied in chain and provided with all keying and polarisation ribs the connectors can be handled automatically with a modern Application Tooling Equipment.

Wiring faults checked and eliminated through high automation.

Application Machines shall provide to print a colour code mark on the connectors cover after wire termination, feasible on all connectors configuration, for connector identification on harnesses.

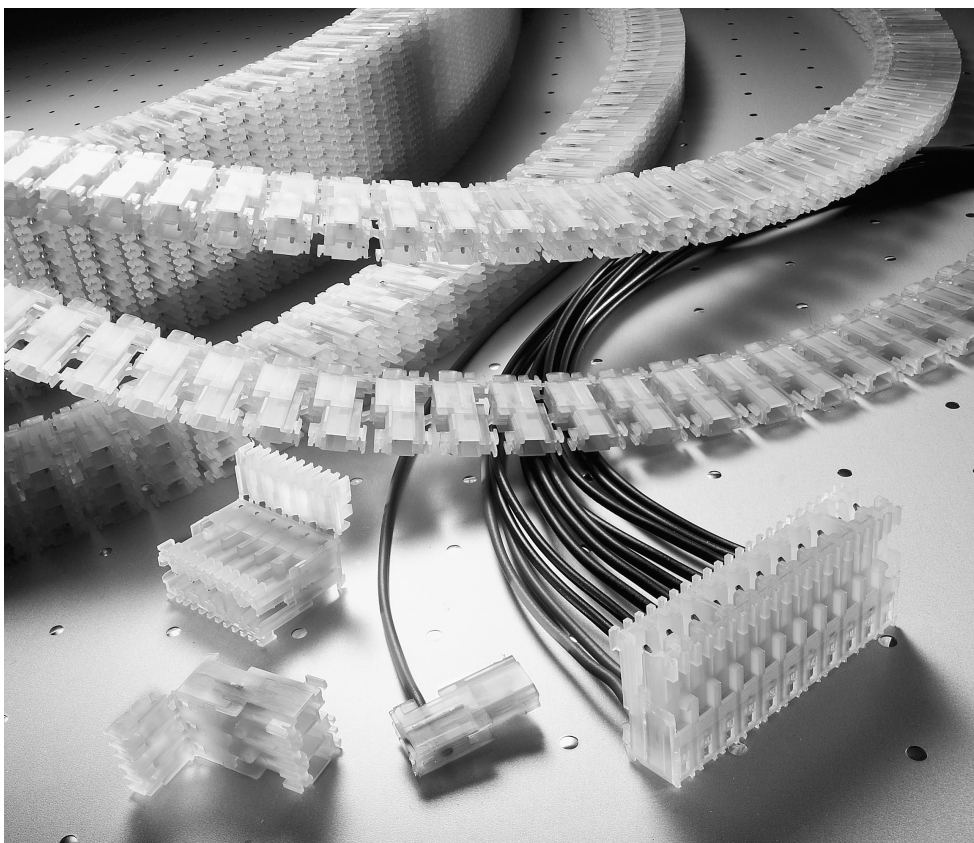

#### Technical Features

- Housing moulded in different materials for different applications
- Standard, Part Numbers with pre-dash 0 (as 0-284471-1) Housing in unfilled PA 6/6, UL 94V-2
- For UL94V0, Part Numbers with pre-dash 1 (as 1-284471-1) Housing in unfilled PA 6/6, UL 94V-0
- High Operating Temperature (up to 130°), Part Numbers with pre-dash 2 (as 2-284471-1) Unfilled PA 4/6, UL 94V-2 (available for TAB Version only)
- Glow Wire 750° no flame, Part Numbers with pre-dash 3 (as 3-284471-1) Housing in unfilled PA 6, UL 94V-2

### Technical Data

**Centerline:**  
5.0mm

**Housing Material:**  
Polyamide, PA 6.6 and PA 6

**Approvals:**  
VDE, UL CSA applied

**Standard Colour:**  
Natural

**Current Voltage:**  
250 V<sub>~</sub>

**Air and Creepage Distance:**  
>3.2mm

**Flammability Rating:**  
According UL 94 V-2

#### TAB Connectors

1-10 position 5.0 pitch connectors with insulation displacement contacts mateable with components according to rast 5 and with tinned copper alloy tab contacts 6.3 x 0.8mm according to DIN 46244 and DIN 17670 Part 1.

#### TAB-BRIDGE Connectors

Same design as TAB Connectors but with a bridge between two adjacent contacts to have a Short Circuit between them.

**Wire Size Range:**  
0.35–1.5 mm<sup>2</sup>

**Current Rating:**  
16 Ampere max. acc. to wire size used

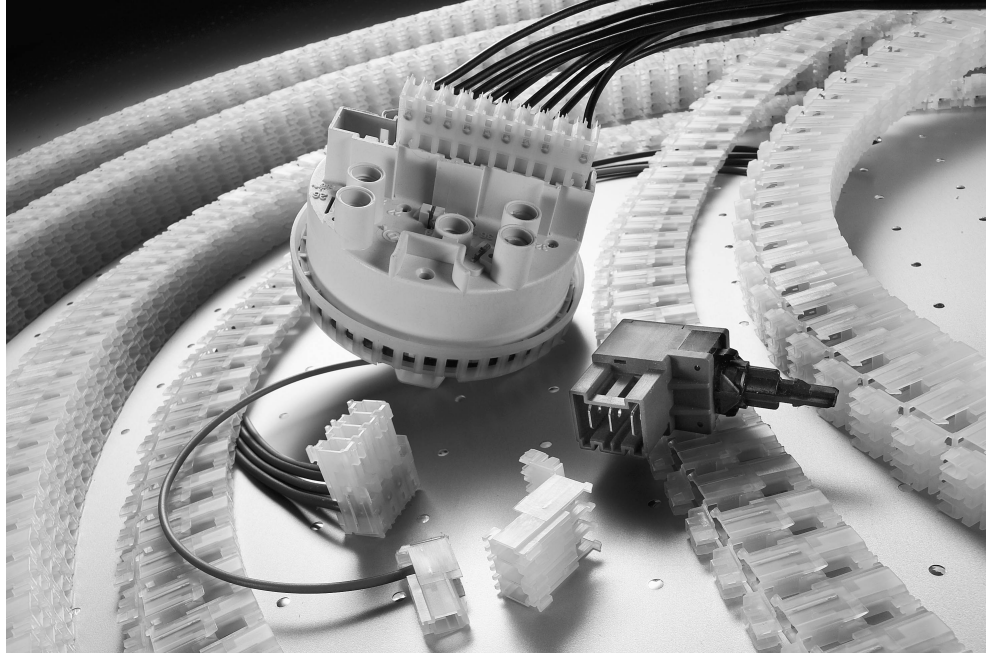

#### PCB Connectors

2–12 position 5.0 mm pitch connectors with insulation displacement contacts mateable with printed circuit boards (PCB)

**Wire Size Range:**  
0.35–0.75 mm<sup>2</sup>

**Current Rating:**  
6 Ampere max. acc. to wire size used

**PC Board:**  
Single or double side, with thickness 1.6±0.2mm, FR4, 2 x 0.35 μm Copper 5μm tinned tracks, 5.0mm pitch

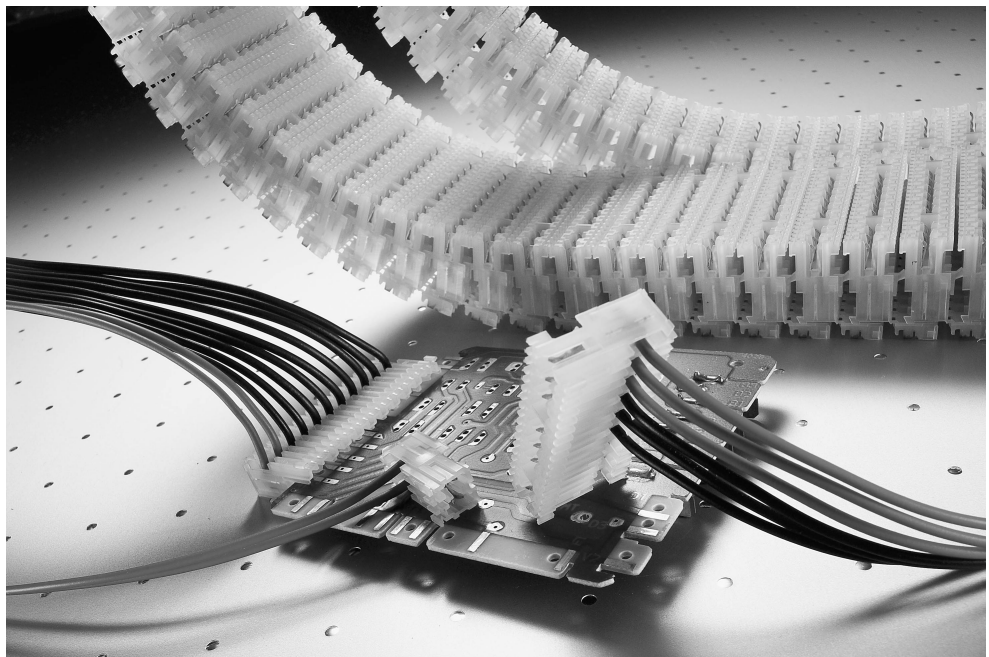



### Keying Plan and Cable Exit

#### Keying Plan from Mating Direction, Fully Keyed Version

- 1 Locking Latch
- 2 Keying Rib
- 3 Polarisation Rib
- 4 Cavity Number
- 5 Motor Mount Special Keying

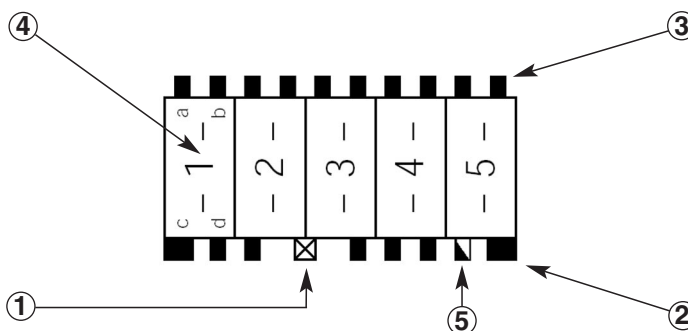

#### Example of Keyed Version: 05-C

This final keying version  
will be produced on the  
Application Tooling  
Equipment

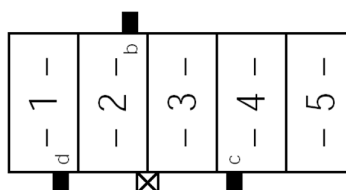

#### Cable Exit

- 1 Double Wire Exit
- 2 Wire Exit 90°
- 3 Wire Exit 180°
- 4 Cover
- 5 Interior Locking Latch  
(for TAB Version only)
- 6 Keying
- 7 Polarisation
- 8 Motor Mount  
Special Keying
- 9 Colour Marking Area to  
identify connectors after  
harnesses are built up

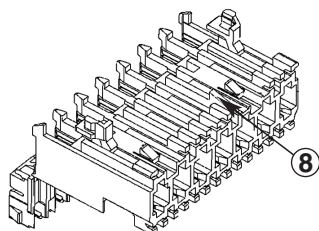
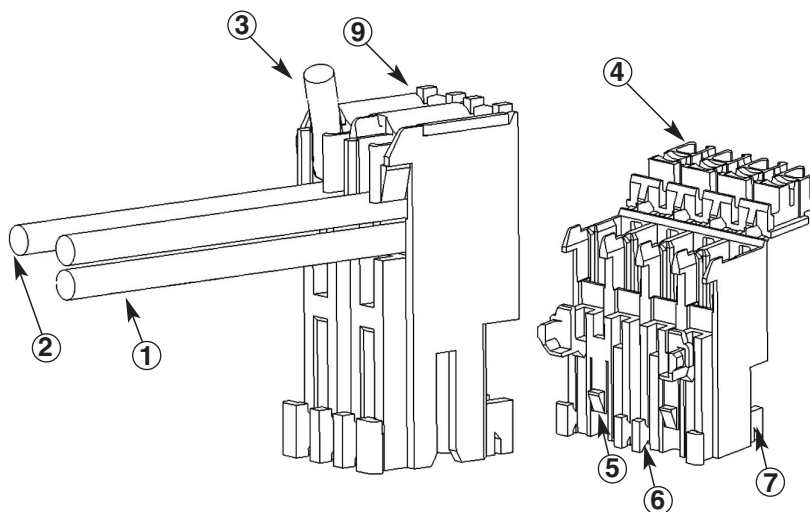

2

Rast 5

### TAB Connector System

#### AMP MONO-SHAPE MARK II TAB Connector System

**No. of Positions:**  
1 to 10 positions

**Contact Material:**  
CuNi2Si

**Contact Finish:**  
Tin Plated

**Current Rating:**  
16 A, up to 4 contacts 16 A

**Insulation Diameter:**  
3.0mm max.

**Insulation Resistance:**  
>10 MΩ

**Wire Size Range:**  
0.35-1.5mm<sup>2</sup>

**Temperature Range:**  
-40°C up to +130°C

**Product Specification:**  
108-20213

**Application Specification:**  
114-20104

No. of Positions	Colour Marking as Shipped	RAST 5 Version	Part Numbers				Packaging Unit
			Standard	UL94V0	High Temperature	Glow Wire 750° no flame	
1	—		0-284471-1	1-284471-1	2-284471-1	3-284471-1	11000
2	—		0-284472-1	1-284472-1	2-284472-1	3-284472-1	5500
3	—		0-284473-1	1-284473-1	2-284473-1	3-284473-1	3520
3	Blue		0-284473-2	1-284473-2	2-284473-2	3-284473-2	3520
4	—		0-284474-1	1-284474-1	2-284474-1	3-284474-1	2640
4	Blue		0-284474-2	1-28444-2	2-284474-2	3-284474-2	2640
5	—		0-284475-1	1-284475-1	2-284475-1	3-284475-1	2200
6	—		0-284476-1	1-284476-1	2-284476-1	3-284476-1	1760
6	Violet		0-284476-4	1-284476-4	2-284476-4	3-284476-4	1760
7	—		0-284477-1	1-284477-1	2-284477-1	3-284477-1	1540

### TAB Connector System (continued)

#### AMP MONO-SHAPE MARK II TAB Connector System

2

Rast 5

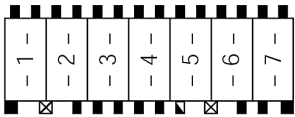
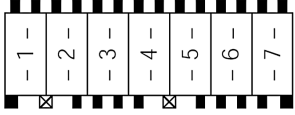
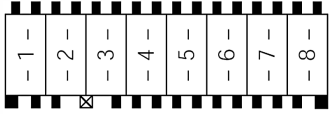
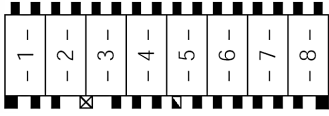
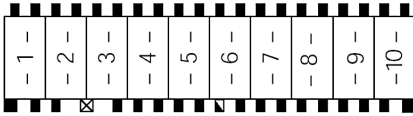
No. of Positions	Colour Marking as Shipped	RAST 5 Version	Part Numbers				Packaging Unit
			Standard	UL94V0	High Temperature	Glow Wire 750° no flame	
7	Blue		0-284477-2	1-284477-2	2-284477-2	3-284477-2	1540
7	Red		0-284477-3	1-284477-3	2-284477-3	3-284477-3	1540
8	—		0-284478-1	1-284478-1	2-284478-1	3-284478-1	1320
8	Blue		0-284478-2	1-284478-2	2-284478-2	3-284478-2	1320
10	—		0-284480-1	1-284480-1	2-284480-1	3-284480-1	1100

### TAB-BRIDGE Connector System - Short Circuit

#### AMP MONO-SHAPE MARK II TAB-BRIDGE Connector System - Short Circuit

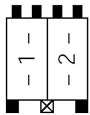
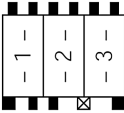
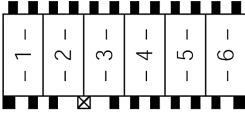
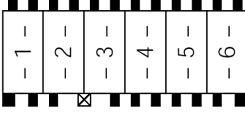
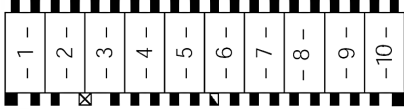
No. of Positions	Colour Marking as Shipped	RAST 5 Version	Bridge Between Cavity Numbers	Part Numbers			Packaging Unit	
				Standard	UL94V0	High Temperature		Glow Wire 750° no flame
2	Blue		1-2	0-284472-2	1-284472-2	2-284472-2	3-284472-2	5500
3	Red		1-2	0-284473-3	1-284473-3	2-284473-3	3-284473-3	3520
6	Blue		1-2-3	0-284476-2	1-284476-2	2-284476-2	3-284476-2	1760
6	Red		1-2	0-284476-3	1-284476-3	2-284476-3	3-284476-3	1760
10	Blue		7-8	0-284480-2	1-284480-2	2-284480-2	3-284480-2	1100

### PCB Connector System

<b>No. of Positions:</b> 2 to 12 positions	<b>Insulation Diameter:</b> 2.8mm max.	<b>Product Specification:</b> 108-20214
<b>Contact Material:</b> Brass	<b>Insulation Resistance:</b> >10 MΩ	<b>Application Specification:</b> 114-20104
<b>Contact Finish:</b> Tin Plated	<b>Wire Size Range:</b> 0.35-0.75mm <sup>2</sup>	
<b>Current Rating:</b> 6 A max.	<b>Temperature Range:</b> -40°C up to +105°C	

### AMP MONO-SHAPE MARK II PCB Connector System

- 1 PC Board
- 2 First Circuit Path
- 3 MONO-SHAPE Connector
- 4 Wire

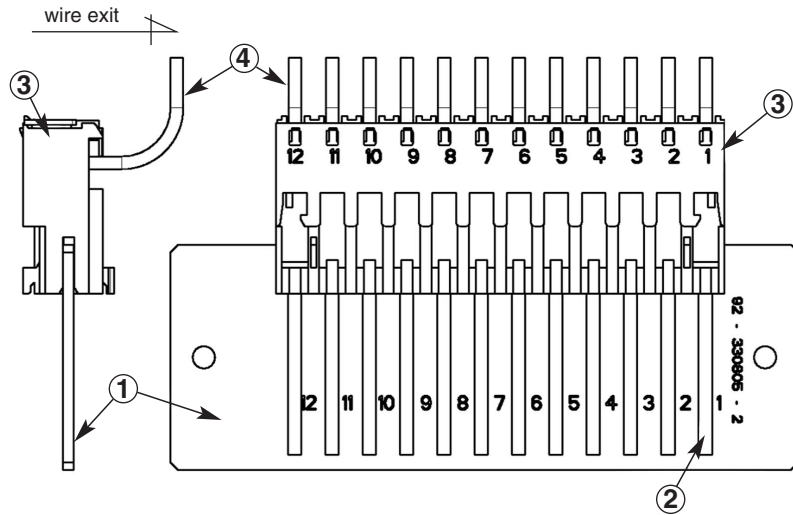

### Notes Concerning the PC Board Layout

See also Customer Drawing  
284482 and Drawing  
93-330805-2 for Test PCB  
Layout

- 1 First circuit path, mate with  
Connector way No. 1
- 2 Slot for connector keying rib  
Adjacent to first and/or last  
way  
Based on connector design,  
for 3.5mm or 7.5mm length
- 3 Hole for locking clip,  
symmetric  
Between two ways  
(diameter 2.5)
- 4 Slot for connector keying rib  
symmetric between two  
ways. Position based on  
connector design, for  
7.5mm length

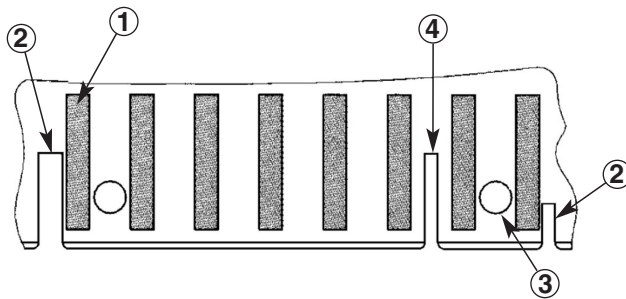







### PCB Connector System (continued)

#### AMP MONO-SHAPE MARK II PCB Connector System

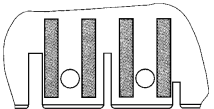
No. of Positions	Colour Marking as Shipped	RAST 5 Version	Part Numbers			Packaging Unit
			Standard	UL94V0	Glow Wire 750° no flame	
2	Green		0-284482-1	1-284482-1	3-284482-1	5500
2	Black		0-284482-2	1-284482-2	3-284482-2	5500
2	Violet		0-284482-3	1-284482-3	3-284482-3	5500
2	Orange		0-284482-4	1-284482-4	3-284482-4	5500
2	Grey		0-284482-5	1-284482-5	3-284482-5	5500
2	Red		0-28482-6	1-284482-6	3-284482-6	5500
3	Green		0-284483-1	1-284483-1	3-284483-1	3520
3	Black		0-284483-2	1-284483-2	3-284483-2	3520
3	Violet		0-284483-3	1-284483-3	3-284483-3	3520
3	Orange		0-284483-4	1-284483-4	3-284483-4	3520
4	Green		0-284484-1	1-284484-1	3-284484-1	2640

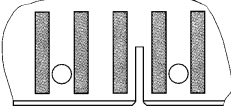
### PCB Connector System (continued)

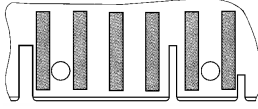
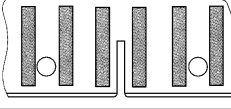
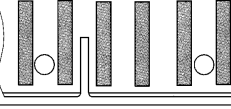
#### AMP MONO-SHAPE MARK II PCB Connector System



No. of Positions	Colour Marking as Shipped	RAST 5 Version	Part Numbers			Packaging Unit
			Standard	UL94V0	Glow Wire 750° no flame	
4	Black		0-284484-2	1-284484-2	3-284484-2	2640
4	Violet		0-284484-3	1-284484-3	3-284484-3	2640
5	Green		0-284485-1	1-284485-1	3-284485-1	2200
5	Black		0-284485-2	1-284485-2	3-284485-2	2200
5	Violet		0-284485-3	1-284485-3	3-284485-3	2200
5	Orange		0-28485-4	1-284485-4	3-284485-4	2200
6	Green		0-284486-1	1-284486-1	3-284486-1	1760
6	Black		0-284486-2	1-284486-2	3-284486-2	1760
6	Violet		0-284486-3	1-284486-3	3-284486-3	1760
6	Orange		0-284486-4	1-284486-4	3-284486-4	1760
6	Grey		0-284486-5	1-284486-5	3-284486-5	1760

2

Rast 5

### PCB Connector System (continued)

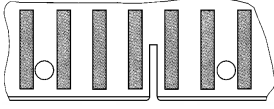
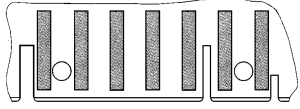
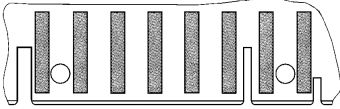
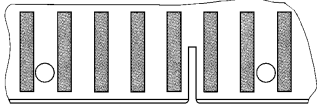
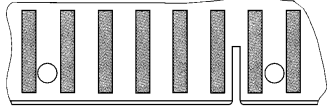
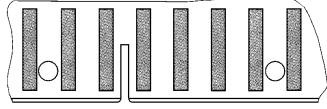
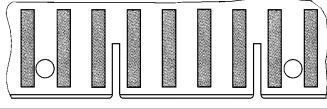
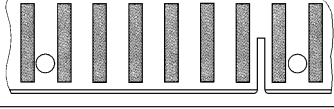

#### AMP MONO-SHAPE MARK II PCB Connector System

No. of Positions	Colour Marking as Shipped	RAST 5 Version	Part Numbers			Packaging Unit
			Standard	UL94V0	Glow Wire 750° no flame	
7	Green		0-284487-1	1-284487-1	3-284487-1	1540
7	Black		0-284487-2	1-284487-2	3-284487-2	1540
7	Violet		0-284487-3	1-284487-3	3-284487-3	1540
8	Green		0-284488-1	1-284488-1	3-284488-1	1320
8	Black		0-284488-2	1-284488-2	3-284488-2	1320
8	Violet		0-28488-3	1-284488-3	3-284488-3	1320
8	Orange		0-284488-4	1-284488-4	3-284488-4	1320
9	Green		0-284489-1	1-284489-1	3-284489-1	1100
9	Black		0-284489-2	1-284489-2	3-284489-2	1100
9	Violet		0-284489-3	1-284489-3	3-284489-3	1100
9	Orange		0-284489-4	1-284489-4	3-284489-4	1100

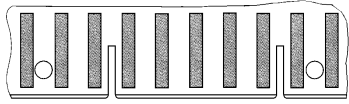
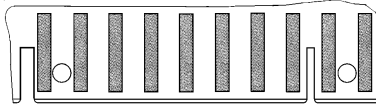
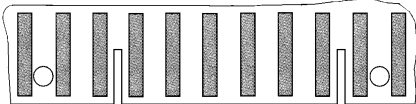
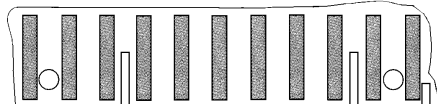
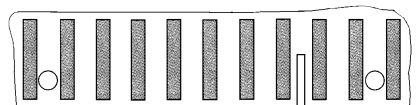
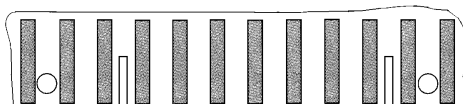

### PCB Connector System (continued)

#### AMP MONO-SHAPE MARK II PCB Connector System

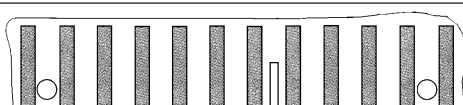
No. of Positions	Colour Marking as Shipped	RAST 5 Version	Part Numbers			Packaging Unit
			Standard	UL94V0	Glow Wire 750° no flame	
10	Green		0-284490-1	1-284490-1	3-284490-1	1100
10	Black		0-284490-2	1-284490-2	3-284490-2	1100
11	Green		0-284491-1	1-284491-1	3-284491-1	880
11	Black		0-284491-2	1-284491-2	3-284491-2	880
11	Violet		0-284491-3	1-284491-3	3-284491-3	880
12	Green		0-284492-1	1-284492-1	3-284492-1	880
12	Black		0-284492-2	1-284492-2	3-284492-2	880
12	Violet		0-284492-3	1-284492-3	3-284492-3	880

2

Rast 5

### Application Tooling

#### Entry Level Semi-Automatic IDC Bench Machines

##### SIM 500P

Part No. 528376-2

##### SIM 500T

Part No. 528377-2

In the Entry Level concept, the application process is shared by two different semi-automatic machines.

The SIM 500P prepares the AMP multifitting Mark II banded IDC connectors. The machine removes the connector from the chain and cuts the keying ribs.

Next, the prepared IDC connectors are applied by the SIM 500T.

To facilitate this, the individual IDC connectors are loaded into a nest and moved automatically into the termination station.

The manually inserted wires are, according to a program,

terminated into the appropriate insulation displacement slots. The cover is then separated from the housing, turned and pushed into final position.

The nest, including the finished harness module, is removed from the easily accessed track.



SIM 500P

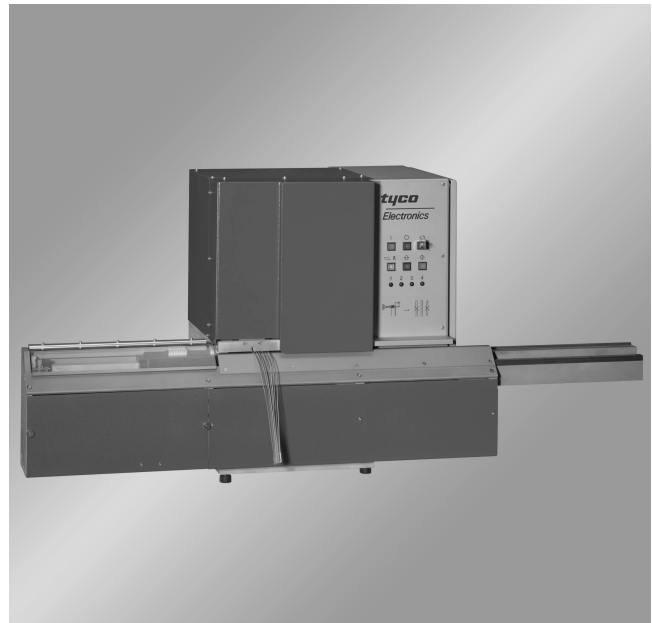

SIM 500T

#### Technical Features

- Processing of all versions of the AMP multifitting Mark II connector system with only minor set up changes.
- Cutting and reliable removal of the reel clips.
- Cutting and reliable removal of the coding and polarisation ribs by means of a preset cutting block.
- Nest capacity per machine cycle
  - one connector 4- to 8-pos.
  - two connectors 2- and 3-pos.
  - four connectors 1-position
- Integrated monitoring of the connector supply.
- Simple operator interface.

#### Technical Data

**Power Supply:**  
230 V AC, 50 Hz

**Air Pressure:**  
6 bar

**Cycle Time:**  
approx. 4 s / connector package  
(without handling time)

#### Technical Features

- Application of all versions of the AMP multifitting Mark II connector, with only minor set up changes.
- Termination of the wire with active support of the IDC contact.
- Termination of two wires (double wire termination) programmable.
- Connector fixture, incorporating three nests for max. 12 positions each.
- Accessible and easily interchangeable mechanical program rail.
- By utilising several connector fixtures and program rails, output and set up times can be optimised.
- Simple operator interface.

#### Technical Data

**Power Supply:**  
230 V AC, 50 Hz

**Air Pressure:**  
6 bar

**Cycle Time:**  
approx. 1.2 s / line  
(without handling time)

### Application Tooling (continued)

#### IDC Workstation – SIM 50

This semi-automatic machine was designed for the sequential processing of AMP multifitting Mark II IDC connector system and its variations such as direct and indirect mating connector with interior or exterior locking.

A processing sequence can consist of one or more IDC connectors of the same or different numbers of positions, but a maximum total of 12 positions.

The specific key coding of the connectors is performed during the termination process by an integrated cutting device.

The wires are manually fed into the machine and then automatically terminated.

Integrated control tests ensure a high quality product.



2

Rast 5

#### Technical Features

- Processing of all versions of the AMP multifitting Mark II connector system without additional set up time.
- Termination of the wire with active support of the IDC contact.
- Termination of two wires in the same slot is programmable.
- Colour coding on the connector cover possible.
- Wire exit angle can be bent 180°.
- Short set up and change-over times.
- High output.
- Correct wire insertion length and key codings are continually checked.
- Good / bad sorter; faulty connections will be destroyed.

#### Technical Data

- Power Supply:**  
230 V AC, 50 Hz
- Air Pressure:**  
6 bar
- Wire Size Range:**  
0.35 mm<sup>2</sup> up to 1.5 mm<sup>2</sup>
- Insulation Diameter Range:**  
1.2 mm up to 3.0 mm
- Wire Type:**  
Stranded conductors

- 50 different production programs can be stored.
- Operator PC interface displaying machine status and production data; different languages available.
- Low maintenance costs and the capability of off-site troubleshooting via modem.
- Ergonomic and easy to operate through a Touch Screen Display.

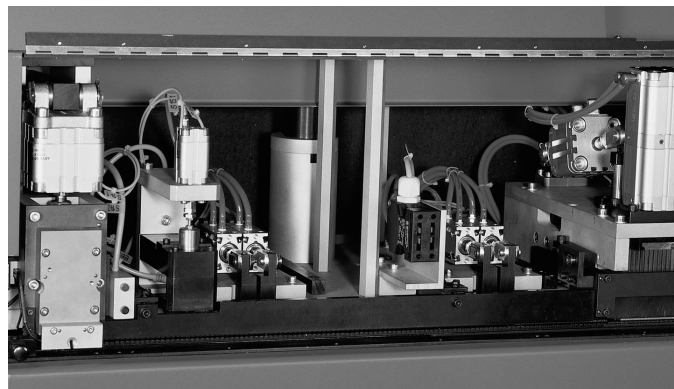

Processing Modules of the SIM 50

### Application Tooling (continued)

#### Flexible Harness Maker – FHM

The FHM is a fully-automatic machine featuring modular set up. It is built to manufacture harnesses by processing both IDC connectors and crimp terminals.

The basic machine includes a 12 wire selector, a station that cuts the wires to length, a stripping station, a double-crimp unit, two crimping presses and wire end ejector for doubling and daisy chains.

A gripper unit takes the wire from the base machine and transfers it to the attached IDC station. Sequential processing allows the manufacturing of cross-overs and bridges as well as double-crimps, depending on the type of IDC connector used.

The IDC workstations are easily reconfigured for processing our different IDC connector systems. They include all the necessary processing operations for IDC termination with minimum change-over and set up times.

Quality checks integrated in the manufacturing process ensure the highest quality harness for every production run.



#### Technical Features

- Manufacturing of harnesses with 2.5 mm pitch IDC connectors and/or 5.0 mm pitch IDC connectors and/or with crimp terminals.
- IDC Workstations are available for the following connector systems:
  - AMP DUOPLUG 2.5
  - AMP DUOPLUG 2.5 Mark II
  - AMP DUOPLUG Power
  - AMP multifitting Mark II
  - AMP MONO-SHAPE Mark II
- The IDC Workstations can also be used as separate semi-automatic machines with manual wire transfer.
- The specific key coding of the IDC connector is done on the IDC Workstation.
- Integrated test equipment checks the coding and the insertion depth of the wire, and performs a continuity test. A spark testing unit is also available as an option.
- Wire printing and single housing insertion possible.
- Operator PC interface displays machine status and production data; different languages available.
- Low maintenance costs and the capability of off-site troubleshooting via modem.
- Ergonomic and easy to operate through a Touch Screen Display.

#### Technical Data

- Power Supply:**  
400 V AC, 50 Hz
- Air Pressure:**  
6 bar
- Wire Size Range:**  
0.22 mm<sup>2</sup> up to 1.5 mm<sup>2</sup>
- Wire Length:**  
220 mm up to 2,500 mm
- Insulation Diameter Range:**  
1.2 mm up to 3.0 mm
- Wire Type:**  
Stranded conductors

### Application Tooling (continued)

#### IDC Harness Maker – IHM Mark III

The new IHM Mark III is a very high performance, fully-automatic machine designed to manufacture parallel jumper harnesses using IDC technology.

The simultaneous feeding of up to 21 wires guarantees high productivity and flexibility and a choice of 2.5 mm or 5.0 mm pitch IDC systems.

The gripper unit on the left side of the machine is able to spread the wires in both directions to enable the production of harnesses using both 2.5 mm and 5.0 mm pitch connectors at the same time.

Available options are a stripper crimper unit with an integrated crimp force analyser and a good/bad sorting unit.

The IDC workstations are easily reconfigured for processing our different IDC connector systems. They include all the necessary processing operations for IDC termination with minimum change-over and set up times.

Quality checks integrated in the manufacturing process ensure the highest quality harness for every production run.

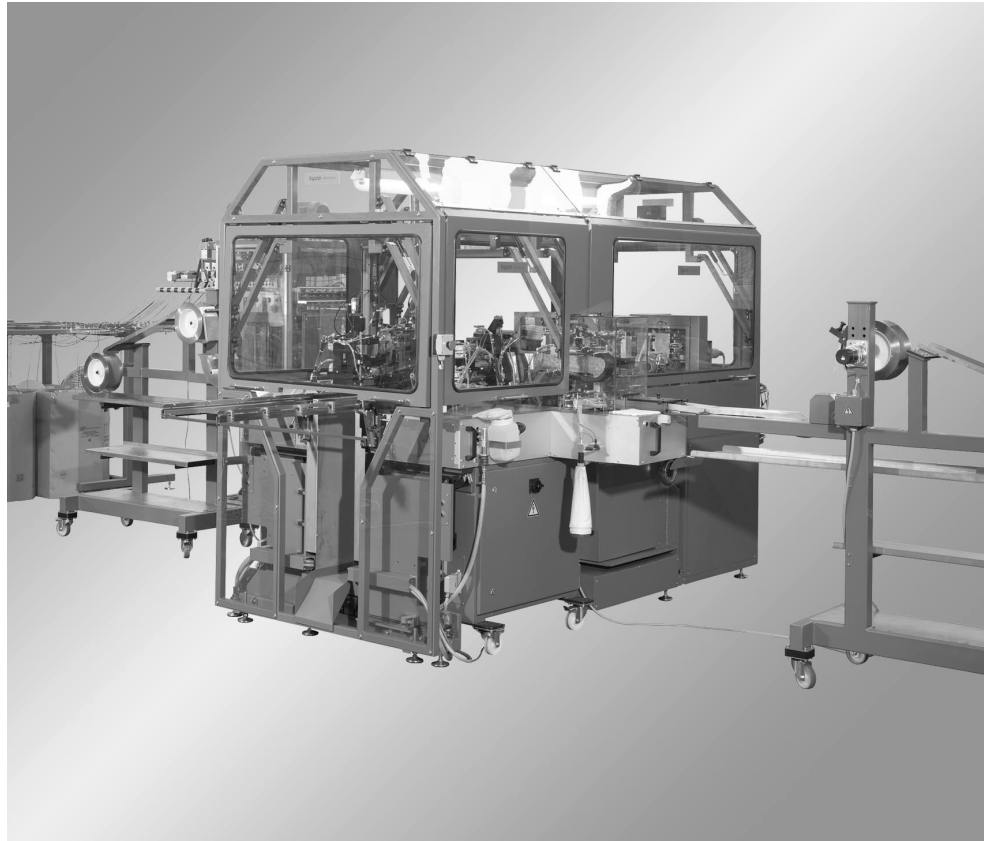

#### Technical Features

- Manufacturing of harnesses using 2.5 mm and/or 5.0 mm pitch IDC systems.
- Very short wire length is possible.
- Option available to produce harnesses with crimp terminals on one side.
- IDC Workstations are available for the following connector systems:
  - AMP DUOPLUG 2.5
  - AMP DUOPLUG 2.5 Mark II
  - AMP DUOPLUG Power
  - AMP multifitting Mark II
  - AMP MONO-SHAPE Mark II
  - AMP MT Edge
- The specific key coding of the IDC connector is done on the IDC Workstation.
- Integrated test equipment checks the coding and the insertion depth of the wire, and performs a continuity test. A spark testing unit is also available as an option.
- Operator PC interface displays machine status and production data; different languages available.
- Low maintenance costs and the capability of off-site troubleshooting via modem.
- Ergonomic and easy to operate through a Touch Screen Display.

#### Technical Data

- Power Supply:**  
400 V AC, 50 Hz
- Air Pressure:**  
6 bar
- Wire Size Range:**  
0.22 mm<sup>2</sup> up to 1.5 mm<sup>2</sup>
- Wire Length:**  
125 mm up to 2,200 mm
- Insulation Diameter Range:**  
1.2 mm up to 3.0 mm
- Wire Type:**  
Stranded conductors

### Introduction

#### AMP Standard Timer Connectors in In-Line Mating Technology

AMP Standard Timer connectors according to RAST 5.0 mm standard have been developed to connect RAST 5 components (like motors, leach pumps, water level regulators, relays and push-button switches) in the Household Appliances Industry.

They meet industry requirements, for example multiple position connectors, secure connection even at inclining mating as well as a sturdy contact design.

AMP Standard Power Timer contacts, for use with Standard Timer housings, are suitable for high density and high current capacity up to 16 A.

Housing is designed for end-to-end stacking without contact loss. They are available in different keying and locking versions from 2- positions to 12-positions.

Standard Timer contacts can be used with stranded wires from 0.5 mm<sup>2</sup> to 2.5 mm<sup>2</sup> and can be double terminated. Of course, the corresponding tooling is available, too.

AMP Standard Timer connectors are tested by VDE and fulfil all requirements acc. to VDE 0700 (air gap, creepage distance, glow wire test, ball pressure test, creepage current strength).

UL recognised component.

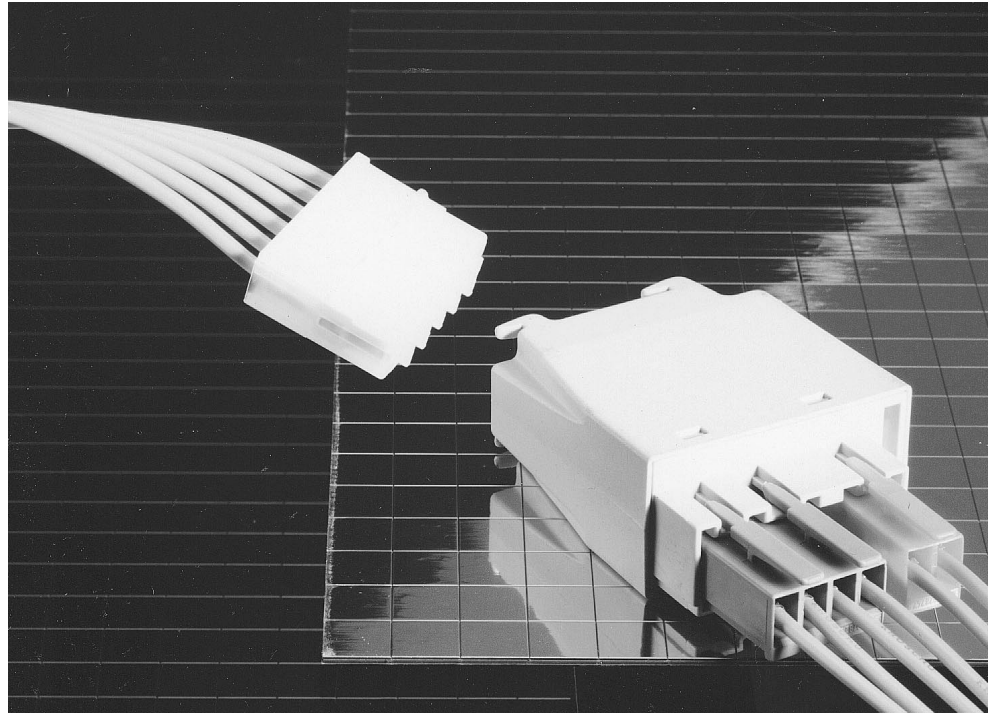

#### Technical Features

**Centerline:**  
5.0 mm

**Available Number of Positions:**  
2- to 12-positions

**Housing Material:**  
Polyamide PA 6.6

**Contact Material:**  
CuSn, CuFe

**Contact Finish:**  
Tin Plated, Silver Plated

**Wire Size Range:**  
from 0.5 to 2.5mm<sup>2</sup>

**Wire Size Diameter:**  
from 2.0 to 3.3mm

**Temperature Range:**  
-40°C to +110°C

**Current Voltage:**  
220 V<sub>~</sub>

**Current Rating:**  
max. 16 A  
Standard Timer: 6 A  
Power Timer: 16 A

**Mating Force Contact:**  
≤ 15 N

**Unmating Force:**  
≤ 8 N

**Air and Creepage Distance:**  
≥ 3.0mm

**Track Resistance:**  
PTI 250

**Glow Wire Test:**  
850°C

**Contacts made for Tabs according:-**  
DIN 46244  
(6.3 x 0.8mm / 4.8 x 0.8mm)  
DIN 46343 Part 2 and 3

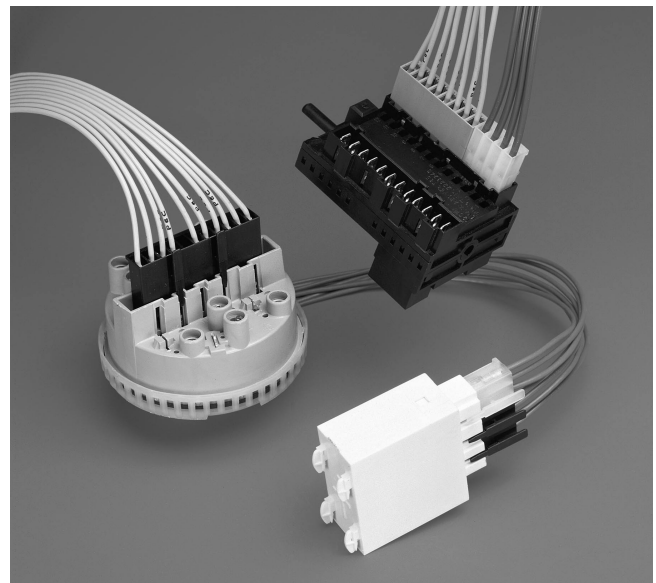

### Interior and Exterior Locking

#### Interior Locking

Connection to the Components according RAST 5 Standard

- 1 Connected Timer Contact
- 2 Standard Timer Housing with Interior Locking
- 3 Keying
- 4 Polarisation
- 5 Locking Latch
- 6 Cover (Secondary Locking)
- 7 RAST 5 Tab Array

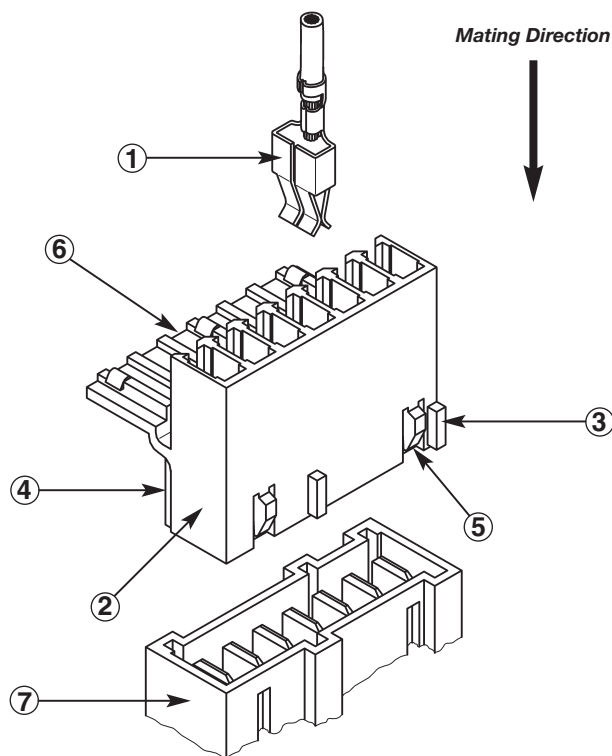

#### Exterior Locking

Connection to the Components according RAST 5 Standard

- 1 Connected Timer Contact
- 2 Standard Timer Housing with Exterior Locking
- 3 Keying
- 4 Polarisation
- 5 Locking Latch
- 6 RAST 5 Tab Array

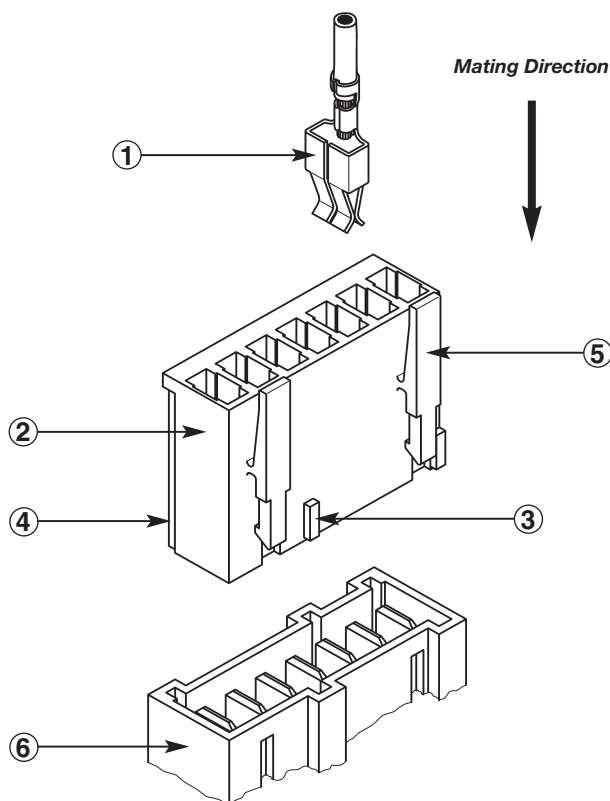

### Keying Plan and Housings

#### Keying Plan from Mating Direction

- 1 Locking Latch
- 2 Keying Rib
- 3 Keying Rib between Cavity
- 4 Slanted Keying Rib
- 5 Polarisation Rib
- 6 Cavity Number

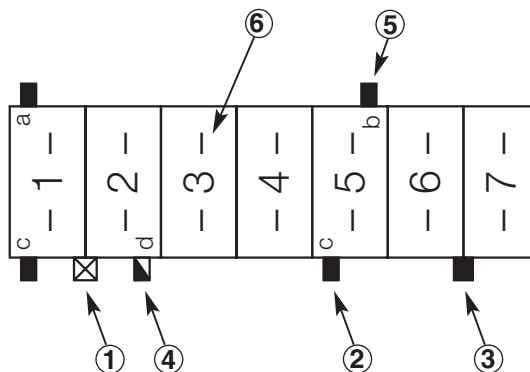

#### AMP Standard Timer Housings 2 Position Rast 5 Variations

Keying Version Colour	RAST 5 Version	Part Numbers		Packaging Unit
		with Interior Locking	with Exterior Locking	
02-A Natural		<b>928344-2</b>	<b>6-928247-2</b>	2.500 / 2.500
02-B Black		2-928344-2	<b>928247-2</b>	2.500 / 3.000
02-C Grey		<b>3-964951-2</b>	8-928247-2	2.500 / 2.500
02-D Blue		—	964983-2	2.500
02-E Green		<b>6-928344-2</b>	<b>5-928247-2</b>	2.500 / 2.500
02-G Violet		5-928344-2	2-964983-2	2.500 / 2.500
02-H Brown		3-928344-2	—	2.500
02-I Orange		2-964951-2	3-928247-2	2.500 / 2.500

**Bold Part Numbers are Preferred Types**



### Housings

#### AMP Standard Timer Housings 2 Position Rast 5 Variations (continued)

Keying Version Colour	RAST 5 Version	Part Numbers		Packaging Unit
		with Interior Locking	with Exterior Locking	
02-K Yellow-Green		—	4-928247-2	2.500
02-L Natural		<b>928343-2</b>	—	3.000
02-M Ultramarine-Blue		—	3-964983-2	2.500
02-O Pink		964951-2	2-928247-2	2.500 / 2.500
02-P Purple		—	7-928247-2	2.500
02-Q Turquoise		4-928344-2	—	2.500

**Bold Part Numbers are Preferred Types**

#### AMP Standard Timer Housings 2 Position Special Variations

Colour	Version	Part Numbers		Packaging Unit
		with Interior Locking	with Exterior Locking	
Natural		7-927740-2	9-928247-2	5.000
Natural		964768-1	—	5.000

2  
Rast 5

### Housings

#### AMP Standard Timer Housings 3 Position Rast 5 Variations

Keying Version Colour	RAST 5 Version	Part Numbers		Packaging Unit
		with Interior Locking	with Exterior Locking	
03-A Natural		<b>928344-3</b>	—	3.000
03-B Black		—	964983-3	2.500
03-D Blue		—	3-928247-3	2.500
03-G Violet		—	2-928247-3	2.500
03-H Brown		—	4-928247-3	2.500
03-K Yellow-Green		—	2-964983-3	2.500

**Bold Part Numbers are Preferred Types**

### Housings

#### AMP Standard Timer Housings 3 Position Special Variations

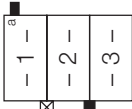
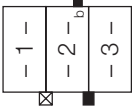
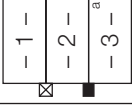
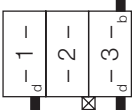
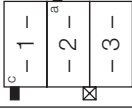
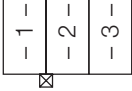
Colour	Version	Part Numbers		Packaging Unit
		with Interior Locking	with Exterior Locking	
Natural		<b>928343-3</b>	—	3.000
Black		2-928343-3	—	3.000
Grey		3-928343-3	—	3.000
Yellow		—	<b>928247-3</b>	2.000
Grey		2-928344-3	—	2.500
Natural		—	5-928247-3	2.500

**Bold Part Numbers are Preferred Types**

### Housings

#### AMP Standard Timer Housings 4 Position Rast 5 Variations

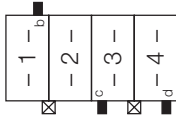
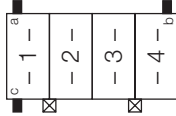
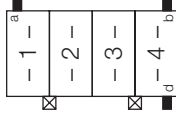
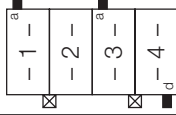
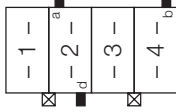
Keying Version Colour	RAST 5 Version	Part Numbers		Packaging Unit
		with Interior Locking	with Exterior Locking	
04-A Natural		<b>928344-4</b>	4-928247-4	2.000 / 1.250
04-B Black		—	5-928247-4	1.250
04-C Grey		3-928344-4	928247-4	2.000 / 1.250
04-F White		—	<b>2-928247-4</b>	1.250
03-G Violet		—	3-928247-4	1.250

#### AMP Standard Timer Housings 4 Position Special Variations

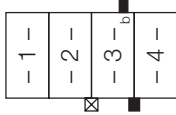
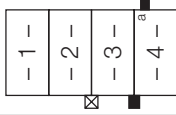
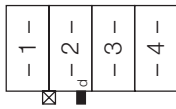
Colour	Version	Part Numbers		Packaging Unit
		with Interior Locking	with Exterior Locking	
Natural		<b>928343-4</b>	—	2.500
Black		2-928343-4	—	2.500
Black		3-928344-4	—	2.500

**Bold Part Numbers are Preferred Types**

### Housings

#### AMP Standard Timer Housings 5 Position Rast 5 Variations

Keying Version Colour	RAST 5 Version	Part Numbers		Packaging Unit
		with Interior Locking	with Exterior Locking	
05-B Black		—	<b>2-928247-5</b>	1.000
05-D Blue		—	3-928247-5	1.000

#### AMP Standard Timer Housings 5 Position Special Variations

Colour	Version	Part Numbers		Packaging Unit
		with Interior Locking	with Exterior Locking	
Natural		<b>928343-5</b>	—	1.000
Black		2-928343-5	—	1.000
Green		—	5-928247-5	1.250
Yellow		—	4-928247-5	1.250
Natural		—	6-928247-5	1.250

**Bold Part Numbers are Preferred Types**

### Housings

#### AMP Standard Timer Housings 6 Position Rast 5 Variations

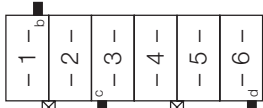
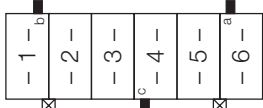
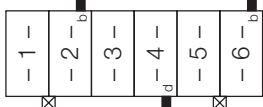
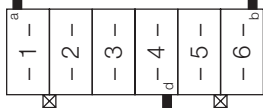
Keying Version Colour	RAST 5 Version	Part Numbers		Packaging Unit
		with Interior Locking	with Exterior Locking	
06-A Natural		—	964983-6	2.500
06-C Grey		—	928247-6	1.000
06-D Blue		—	<b>2-928247-6</b>	1.000
06-E Green		—	3-928247-6	1.000

**Bold Part Numbers are Preferred Types**

### Housings

#### AMP Standard Timer Housings 6 Position Special Variations

Colour	Version	Part Numbers		Packaging Unit
		with Interior Locking	with Exterior Locking	
Natural		<b>928343-6</b>	—	1.000
Black		2-928343-6	—	1.000
Natural		928151-6	—	1.500
Beige		—	7-928247-6	1.000
Yellow		—	4-928247-6	1.000
Brown		—	5-928247-6	1.000
Natural		—	6-928247-6	1.000
Natural		2-928344-6	—	1.500
Green		3-928344-6	—	1.500



**Bold Part Numbers are Preferred Types**

### Housings

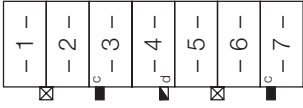
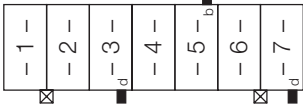
#### AMP Standard Timer Housings 7 Position Rast 5 Variations

Keying Version Colour	RAST 5 Version	Part Numbers		Packaging Unit
		with Interior Locking	with Exterior Locking	
07-A/S Natural		928151-7	—	1.300
07-C Grey		—	<b>928247-7</b>	700

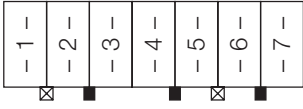
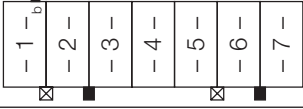
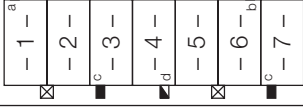
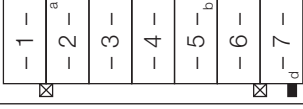
#### AMP Standard Timer Housings 7 Position Special Variations

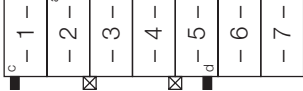
Colour	Version	Part Numbers		Packaging Unit
		with Interior Locking	with Exterior Locking	
Natural		<b>928343-7</b>	—	500
Black		2-928343-7	—	500
Natural		<b>928344-7</b>	—	500
Blue		—	2-928247-7	800
		2-928151-7 Green	4-928247-7 Natural	1.300 / 1.000
Natural		—	5-928247-7	1.000
Natural		—	6-928247-7	1.000

**Bold Part Numbers are Preferred Types**



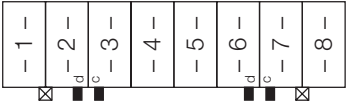

### Housings

#### AMP Standard Timer Housings 8 Position Rast 5 Variations

Keying Version Colour	RAST 5 Version	Part Numbers		Packaging Unit
		with Interior Locking	with Exterior Locking	
08-D Blue		—	928247-8	800

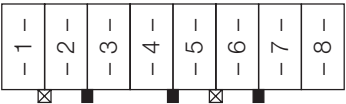
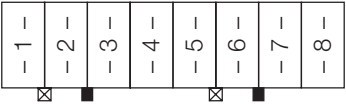
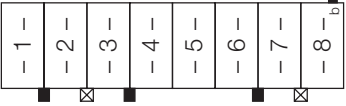
#### AMP Standard Timer Housings 8 Position Special Variations

Colour	Version	Part Numbers		Packaging Unit
		with Interior Locking	with Exterior Locking	
Natural		928343-8	—	1.000
Black		<b>2-928343-8</b>	—	1.000
Grey		3-928343-8	—	1.000
Natural		—	2-928247-7	800

**Bold Part Numbers are Preferred Types**

2  
Rast 5

### Housings

#### AMP Standard Timer Housings 9 Position Rast 5 Variations

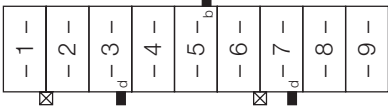
Keying Version Colour	RAST 5 Version	Part Numbers		Packaging Unit
		with Interior Locking	with Exterior Locking	
09-D Blue		—	2-928247-9	600

#### AMP Standard Timer Housings 9 Position Special Variations

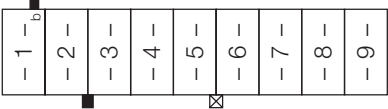
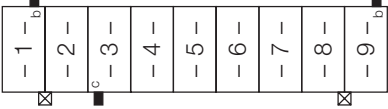
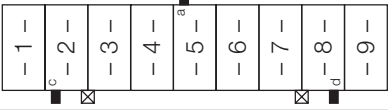
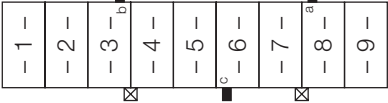
Colour	Version	Part Numbers		Packaging Unit
		with Interior Locking	with Exterior Locking	
Natural		<b>927740-9</b>	—	1.000
Natural		928151-9	—	1.000
Yellow		—	928247-9	500
Brown		—	3-928247-9	600

**Bold Part Numbers are Preferred Types**

### Housings

#### AMP Standard Timer Housings 10 Position Special Variations

Keying Version Colour	RAST 5 Version	Part Numbers		Packaging Unit
		with Interior Locking	with Exterior Locking	
Brown		—	<b>1-928247-0</b>	1.400
Grey		—	2-928247-0	500

#### AMP Standard Timer Housings 11 Position Rast 5 Variations

Keying Version Colour	RAST 5 Version	Part Numbers		Packaging Unit
		with Interior Locking	with Exterior Locking	
11-B Black		—	<b>1-928247-1</b> Yellow	1.000

#### AMP Standard Timer Housings 11 Position Special Variations

Colour	Version	Part Numbers		Packaging Unit
		with Interior Locking	with Exterior Locking	
Natural		<b>1-927740-1</b>	—	800
Blue		—	2-928247-1	1.000

#### AMP Standard Timer Housings 12 Position Special Variations

Colour	Version	Part Numbers		Packaging Unit
		with Interior Locking	with Exterior Locking	
Natural		<b>1-927740-2</b>	—	700

**Bold Part Numbers are Preferred Types**

### Standard Timer Connector and Contacts

#### Technical Data

**Material:**

Brass, Tin Plated

**Mating Part:**

6.3 Tab

**Wire:**

FLK 0.5/0.75 and 1.5mm<sup>2</sup>

**Current Carrying Capacity to 6A:**

- 1 = Wire 0.50mm<sup>2</sup>, 11pos. housing
- 2 = Wire 0.75mm<sup>2</sup>, 11pos. housing
- 3 = Wire 0.50mm<sup>2</sup>, 2pos. housing
- 4 = Wire 0.75mm<sup>2</sup>, 2pos. housing

**Current Carrying Capacity to 16A:**

- 5 = Wire 1.50mm<sup>2</sup>, 11pos. housing
- 6 = Wire 1.50mm<sup>2</sup>, 2pos. housing

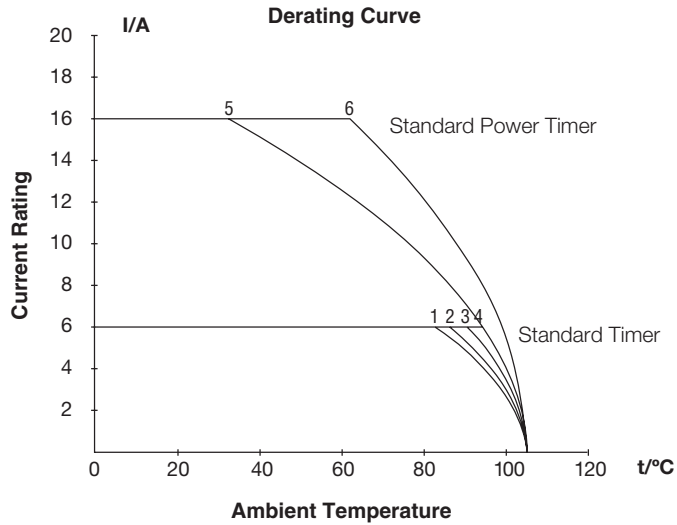

#### Standard Timer Contacts with One Locking Lance

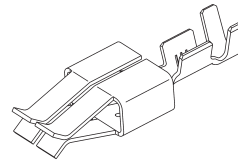

Wire Size Range (mm <sup>2</sup> )	Insulation Diameter Range (mm)	Material	Finish	Part Number	Packaging Unit
0.5–1.0	1.4–2.3	CuZn/Brass	Tin Plated	<b>928820-1</b>	3.000
1.0–2.5	3.0–4.3	CuZn/Brass	Tin Plated	<b>926973-1</b>	2.500

#### Standard Timer Contacts with Two Locking Lances

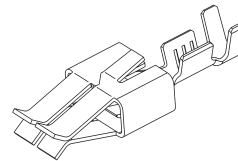

Wire Size Range (mm <sup>2</sup> )	Insulation Diameter Range (mm)	Material	Finish	Part Number	Packaging Unit
0.5–1.0	1.4–2.3	CuZn/Brass	Tin Plated	<b>964201-1</b>	3.000
1.0–2.5	3.0–4.3	CuZn/Brass	Tin Plated	<b>964202-1</b>	2.000

#### Standard Power Timer

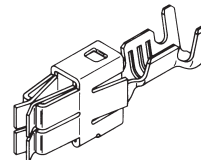

Wire Size Range (mm <sup>2</sup> )	Insulation Diameter Range (mm)	Material	Finish	Part Number	Packaging Unit
1.0–2.5	2.2–3.0	CuFe/Copper Iron	Tin Plated	<b>964203-1</b>	2.300
1.0–2.5	2.2–3.0	CuFe/Copper Iron	Silver Plated	<b>964203-5</b>	2.300
1.5–3.0	max. 2 x 3.0	CuFe/Copper Iron	Tin Plated	<b>964204-1</b>	2.000
1.5–3.0	max. 2 x 3.0	CuFe/Copper Iron	Silver Plated	<b>964204-5</b>	2.000

**Bold Part Numbers are Preferred Types**

---

## Engineering Notes

---



---

**Engineering Notes**

---



## X-ON Electronics

Largest Supplier of Electrical and Electronic Components

*Click to view similar products for [Terminals](#) category:*

*Click to view products by [TE Connectivity](#) manufacturer:*

Other Similar products are found below :

[00-054007-01074-6](#) [00-054007-70206-1](#) [00-054007-70210-8](#) [00-054007-70217-7](#) [00-054007-70226-9](#) [00-054007-70228-3](#) [00-054007-70248-1](#) [00-054007-70256-6](#) [00-054007-70301-3](#) [00-054007-70316-7](#) [0-0320562-0](#) [00-054007-49560-4](#) [00-054007-70209-2](#) [00-054007-70225-2](#) [00-054007-70227-6](#) [00-054007-70231-3](#) [00-054007-70241-2](#) [00-054007-70242-9](#) [00-054007-70244-3](#) [00-054007-70246-7](#) [00-054007-70263-4](#) [00-054007-70288-7](#) [00-054007-70290-0](#) [00-054007-70300-6](#) [00-054007-70304-4](#) [01-2065-1-0216](#) [01-2900-1-04412](#) [00581P0075](#) [600TS-10](#) [60205-1](#) [604200-1](#) [605601-1](#) [60598-1-CUT-TAPE](#) [61314-6-C](#) [61810-3](#) [61-S](#) [61-SN](#) [626-0194](#) [62-NBM-A](#) [62-SN](#) [62-SP](#) [63-S](#) [640179-1](#) [M55155/059I03](#) [M55155/079C01](#) [M55155/099H02](#) [M55155/109H01](#) [M55155/109H02](#) [M55155/12XH05](#) [M55155/16XH02](#)