

THIS DRAWING IS UNPUBLISHED. RELEASED FOR PUBLICATION
 © COPYRIGHT - By - ALL RIGHTS RESERVED.

LOC	DIST	REVISIONS					
FT	0	P	LTR	DESCRIPTION	DATE	DWN	APVD
			C14	REVISED PER ECO-13-016787	29OCT2013	KH	MM

PHYSICAL PROPERTIES:
 HOUSING MATERIAL: THERMOPLASTIC, PC
 FLAMABILITY: UL94V-0
 COLOR: BLACK

TERMINAL:
 TERMINALS: BRASS, TIN PLATED
 SCREWS: 6-32 STEEL, NICKEL PLATED

MECHANICAL:
 PITCH: .437
 WIRE RANGE: 14-22 AWG
 RECOMMENDED TIGHTENING TORQUE: 12IN-LB

ELECTRICAL PROPERTIES:
 MAX CURRENT: 25A
 OPERATING VOLTAGE: 300V

ENVIRONMENTAL PROPERTIES:
 OPERATING TEMP: -40°C TO 120°C

- 1 MARKED WITH WHITE INK APPROX AS SHOWN.
- 2 SEE FIGURE.
- 3 PRELIMINARY PART NUMBER.
- 4 TE LOGO LOCATED APPROXIMATE AREA SHOWN.

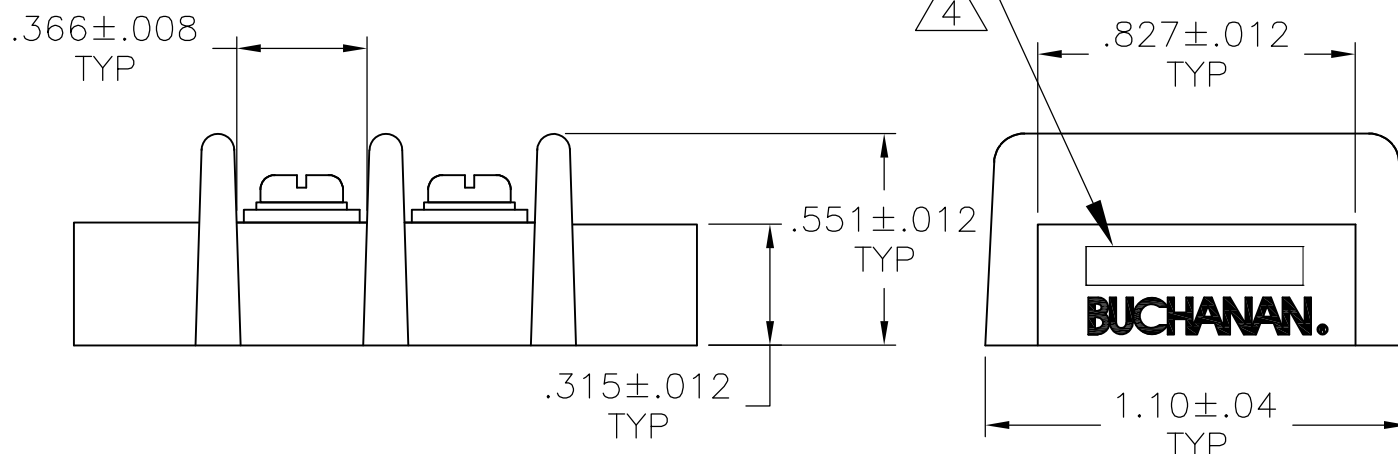
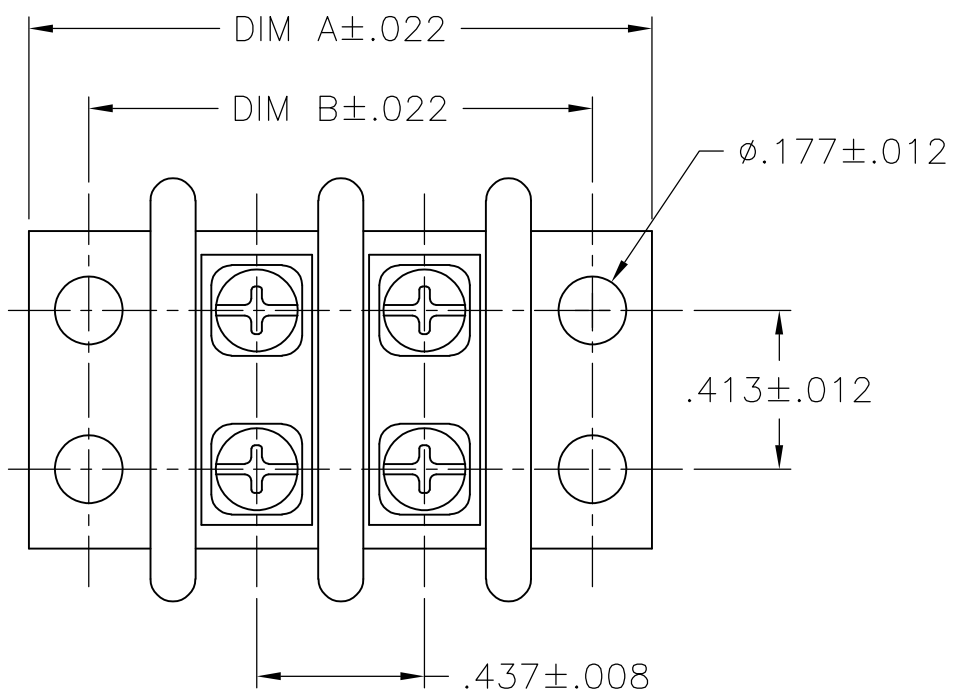

11.764	12.110	26	2-1546671-6
11.327	11.673	25	2-1546671-5
10.90	11.236	24	2-1546671-4
10.453	10.799	23	2-1546671-3
10.016	10.362	22	2-1546671-2
9.579	9.925	21	2-1546671-1
9.142	9.488	20	2-1546671-0
8.705	9.051	19	1-1546671-9
8.268	8.614	18	1-1546671-8
7.831	8.177	17	1-1546671-7
7.394	7.740	16	3-1546671-4
7.394	7.740	16	3-1546671-0
7.394	7.740	16	2-1546671-9
7.394	7.740	16	1-1546671-6
6.957	7.303	15	1-1546671-5
6.520	6.866	14	3-1546671-3
6.520	6.866	14	2-1546671-8
6.520	6.866	14	1-1546671-4
6.083	6.429	13	1-1546671-3
5.646	5.992	12	1-1546671-2
5.209	5.555	11	1-1546671-1
4.772	5.118	10	1-1546671-0
4.335	4.681	9	2-1546671-7
4.335	4.681	9	1546671-9
3.898	4.244	8	1546671-8
3.461	3.807	7	1546671-7
3.024	3.370	6	3-1546671-1
3.024	3.370	6	1546671-6
2.587	2.933	5	1546671-5
2.150	2.496	4	1546671-4
1.713	2.059	3	1546671-3
1.276	1.622	2	1546671-2
DIM B	DIM A	NO OF POS	PART NUMBER

THIS DRAWING IS A CONTROLLED DOCUMENT.		DWN S SCHEGEL 4/4/03	STE TE Connectivity	
DIMENSIONS: INCHES		CHK C RICHARD 4/4/03		
TOLERANCES UNLESS OTHERWISE SPECIFIED:		APVD C RICHARD 4/4/03	NAME	
0 PLC ± -		PRODUCT SPEC		
1 PLC ± -		APPLICATION SPEC		
2 PLC ± .01		SIZE		
3 PLC ± .005		CAGE CODE		
4 PLC ± -		DRAWING NO		
ANGLES ± 2'		RESTRICTED TO		
MATERIAL		WEIGHT		
FINISH		A3 00779 C-1546671		
		CUSTOMER DRAWING		
		SCALE NTS SHEET 1 OF 3 REV C14		

THIS DRAWING IS UNPUBLISHED. RELEASED FOR PUBLICATION
 © COPYRIGHT - By - ALL RIGHTS RESERVED.

LOC	DIST	REVISIONS					
FT	0	P	LTR	DESCRIPTION	DATE	DWN	APVD
		-		SEE SHEET 1	-	-	-

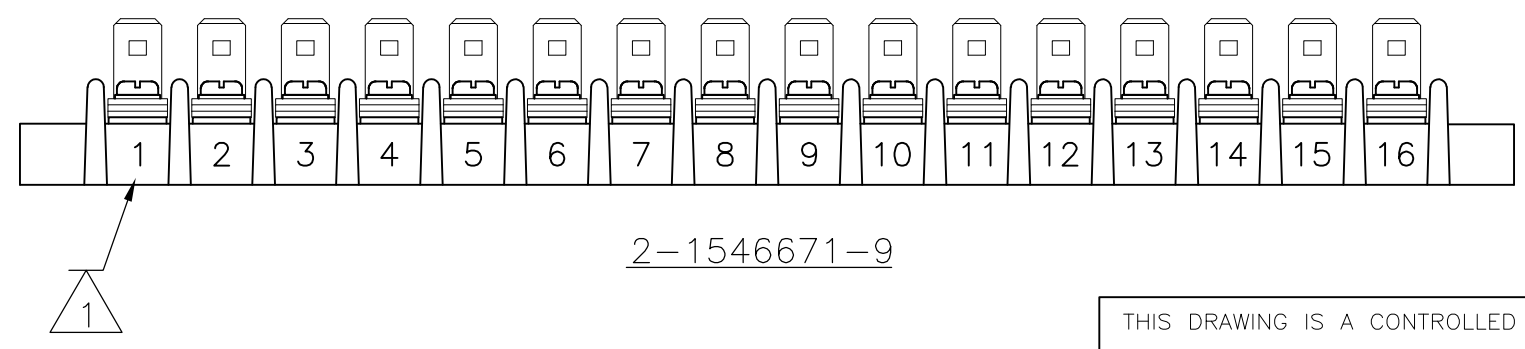
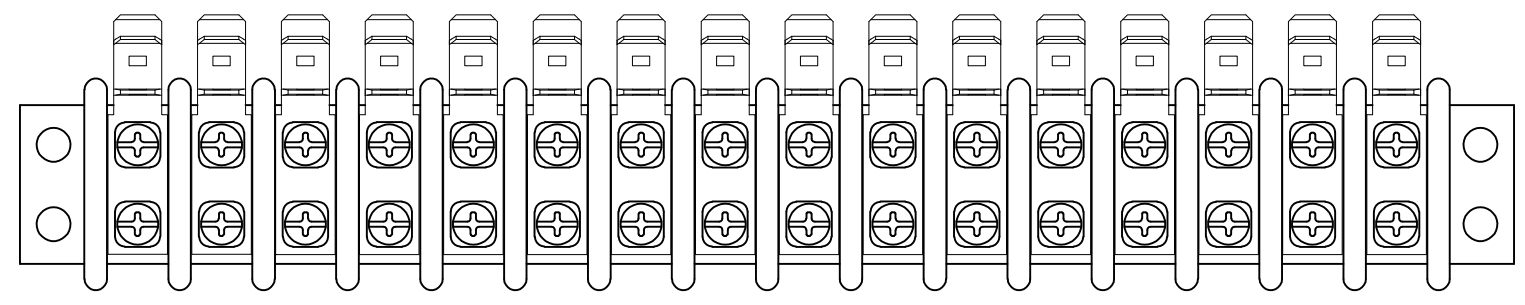
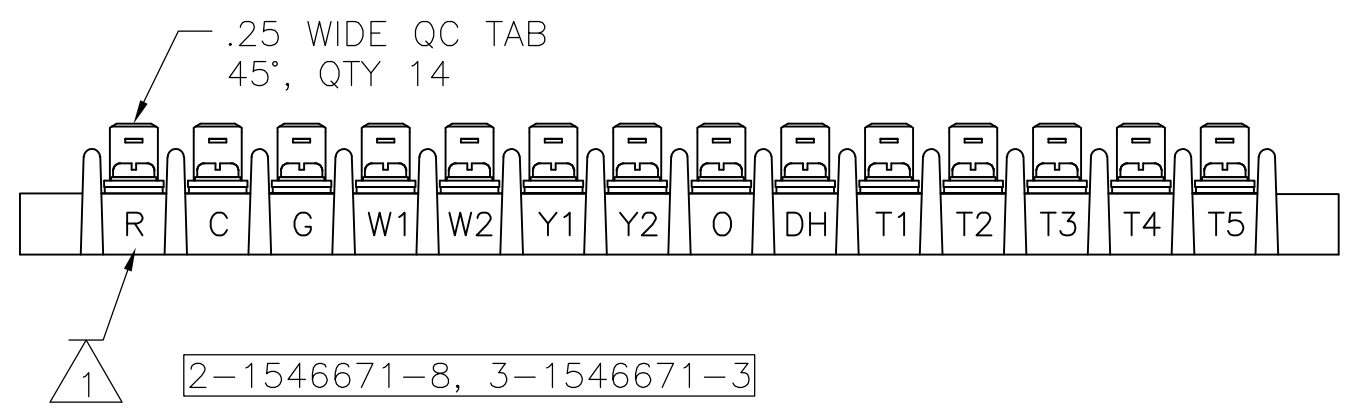
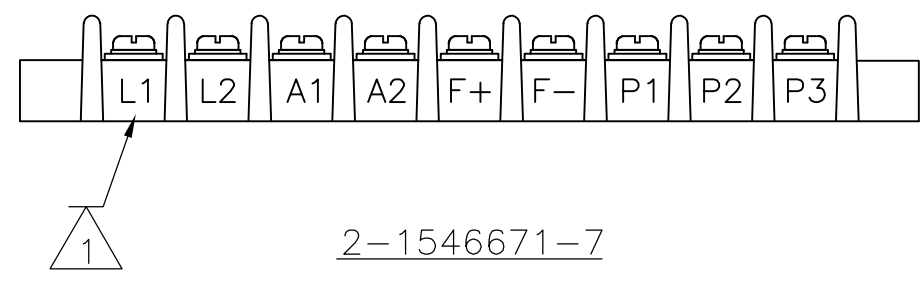

THIS DRAWING IS A CONTROLLED DOCUMENT.		DWN	S SCHEGEL	4/4/03	 TE Connectivity	NAME		DOUBLE ROW BARRIER STRIP W/ WIRE CLAMP, .437 SPACING		
DIMENSIONS: INCHES 		CHK	C RICHARD	4/4/03		APVD		C RICHARD		4/4/03
		TOLERANCES UNLESS OTHERWISE SPECIFIED:		PRODUCT SPEC		APPLICATION SPEC		RESTRICTED TO		
MATERIAL		FINISH		WEIGHT		SIZE	CAGE CODE	DRAWING NO	RESTRICTED TO	
-		-		-		A3	00779	C-1546671	-	
CUSTOMER DRAWING					SCALE	NTS	SHEET	2 OF 3	REV	C14

THIS DRAWING IS UNPUBLISHED. RELEASED FOR PUBLICATION
 © COPYRIGHT - By - ALL RIGHTS RESERVED.

LOC	DIST	REVISIONS					
FT	0	P	LTR	DESCRIPTION	DATE	DWN	APVD
		-		SEE SHEET 1	-	-	-

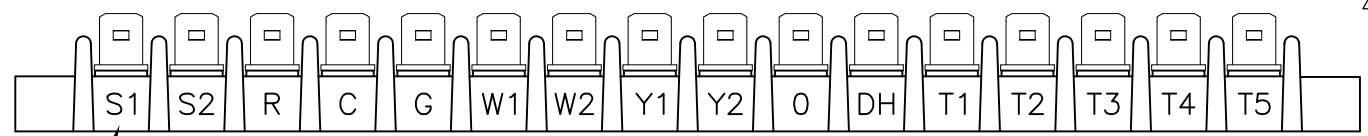
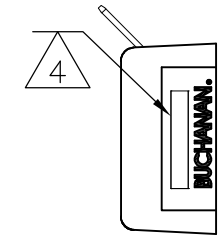
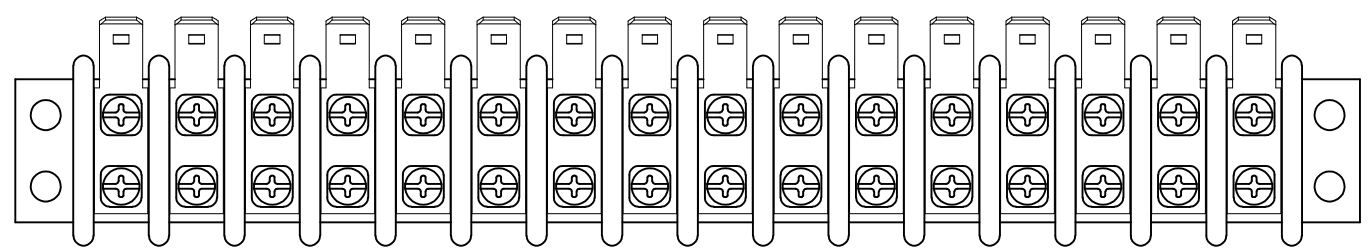

3-1546671-0, 3-1546671-4

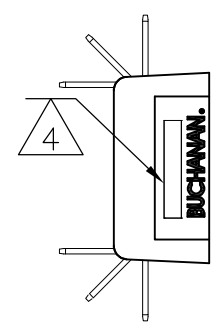
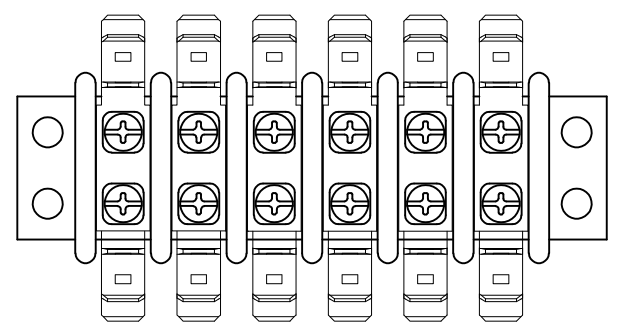
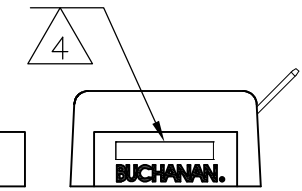

3-1546671-1

THIS DRAWING IS A CONTROLLED DOCUMENT.		DWN	S SCHEGEL	4/4/03	TE Connectivity			
DIMENSIONS: INCHES 		CHK	C RICHARD	4/4/03				
		APVD	C RICHARD	4/4/03				
TOLERANCES UNLESS OTHERWISE SPECIFIED: 0 PLC ± - 1 PLC ± - 2 PLC ± .01 3 PLC ± .005 4 PLC ± - ANGLES ± 2°		PRODUCT SPEC		NAME				
		APPLICATION SPEC		DOUBLE ROW BARRIER STRIP W/ WIRE CLAMP, .437 SPACING				
MATERIAL		WEIGHT		SIZE		CAGE CODE	DRAWING NO	RESTRICTED TO
-		-		A3		00779	C-1546671	-
CUSTOMER DRAWING				SCALE	NTS	SHEET	3 OF 3	REV
								C14

X-ON Electronics

Largest Supplier of Electrical and Electronic Components

Click to view similar products for [Barrier Terminal Blocks](#) category:

Click to view products by [TE Connectivity](#) manufacturer:

Other Similar products are found below :

[CR151D20104](#) [670A-RZ-15-KT20](#) [6C1N03](#) [6PCR-02](#) [6PCR-02-008](#) [6PCR-05-008](#) [6PCR-08-008](#) [6PCR-09-008](#) [6PCR-13-006](#) [6PCR-15-006](#) [6PCR-21-006](#) [6PCV-06-008](#) [6PCV-06-716](#) [6PCV-09-001](#) [6PCV-10-009](#) [6PCV-15-008](#) [6PCV-17-1206](#) [6PCV-20-323](#) [6PCV-20-720](#) [6PCV-30-006](#) [6STR-06-006](#) [6STR-08-006](#) [6STR-12-008](#) [6STR-13-006](#) [6STR-14-008](#) [6STR-16-008](#) [6STR-17-008](#) [6STR-21-008](#) [6STR-25-008](#) [6STR-27-008](#) [6STV-03-006](#) [6STV-03-008](#) [6STV-04-006](#) [6STV-09-006](#) [6STV-10-006](#) [6WWR-03-693](#) [6WWV-12-008](#) [72212603](#) [72504-C-50](#) [72506-C](#) [72507-C-50](#) [73203](#) [75505-C](#) [75505-C-50](#) [75510-C](#) [77010-50](#) [7C1N08](#) [812-GP-3/4ST-09](#) [8-1437402-5](#) [8PCR-06-006](#)