

LOC		DIST		REVISIONS			
P	LTR	DESCRIPTION	DATE	DWN	APVD	REV	APPD
AD	00	AA2	REVISED PER ECO-20-006229	21MAY2020	KR	JS	

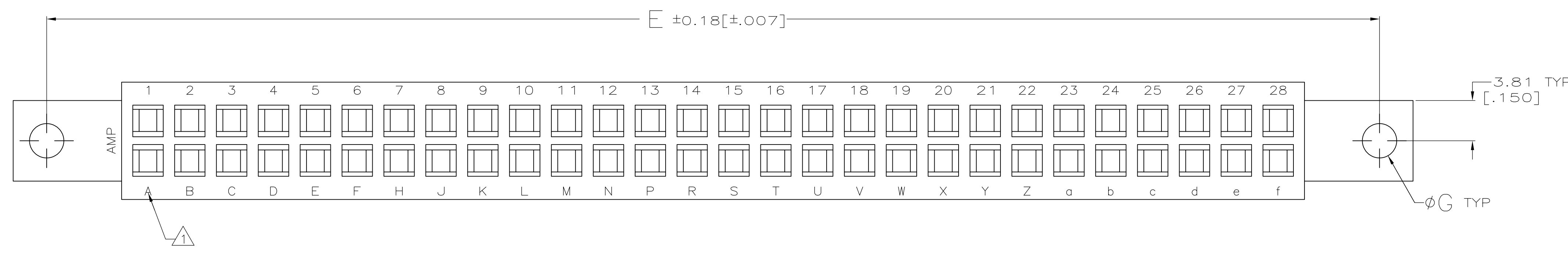

DIMENSIONS:		TOLERANCES UNLESS OTHERWISE SPECIFIED:		MATERIAL:		FINISH:		WEIGHT:		SCALE:		SHEET:		REV:	
0	PLC	±	-	GLASS FILLED	-	-	-	4:1	1	2	AA2				
1	PLC	±	-	POLYESTER	-	-	-								
2	PLC	±	-	COLOR: BLACK	-	-	-								
3	PLC	±	0.13 [.005]												
4	PLC	±	-												
5	PLC	±	-												
6	PLC	±	-												
7	PLC	±	-												
8	PLC	±	-												
9	PLC	±	-												
10	PLC	±	-												
11	PLC	±	-												
12	PLC	±	-												
13	PLC	±	-												
14	PLC	±	-												
15	PLC	±	-												
16	PLC	±	-												
17	PLC	±	-												
18	PLC	±	-												
19	PLC	±	-												
20	PLC	±	-												
21	PLC	±	-												
22	PLC	±	-												
23	PLC	±	-												
24	PLC	±	-												
25	PLC	±	-												
26	PLC	±	-												
27	PLC	±	-												
28	PLC	±	-												

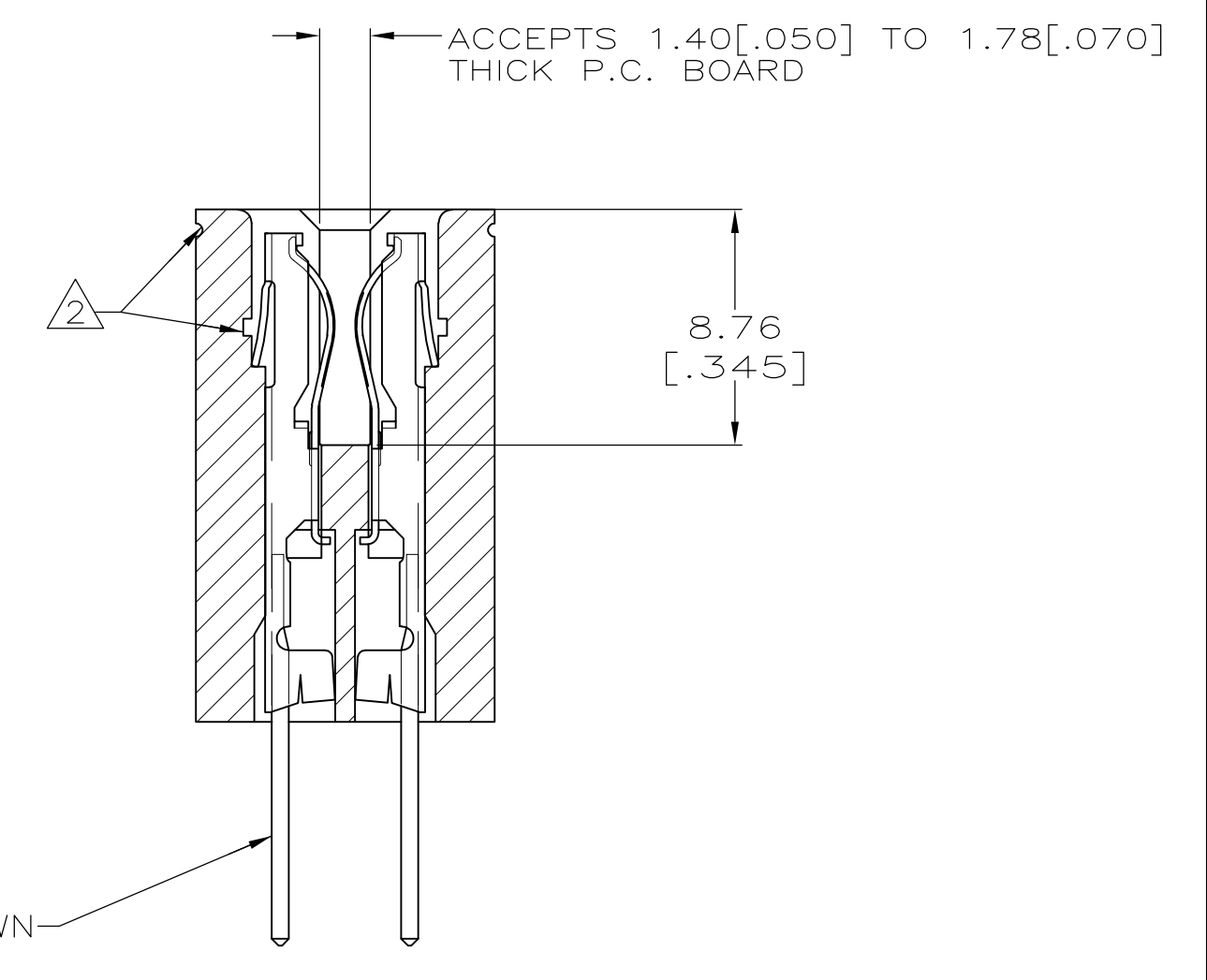
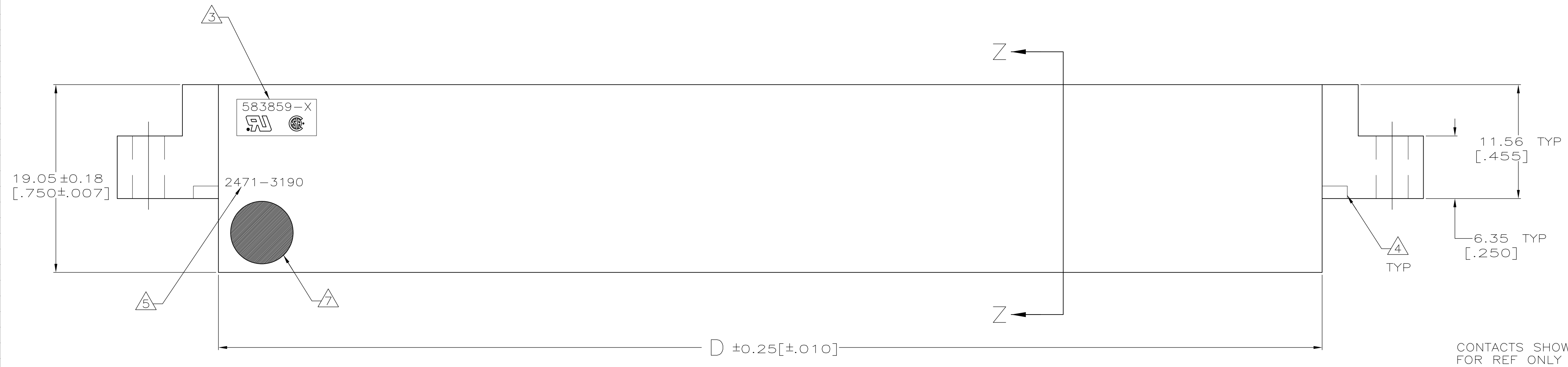
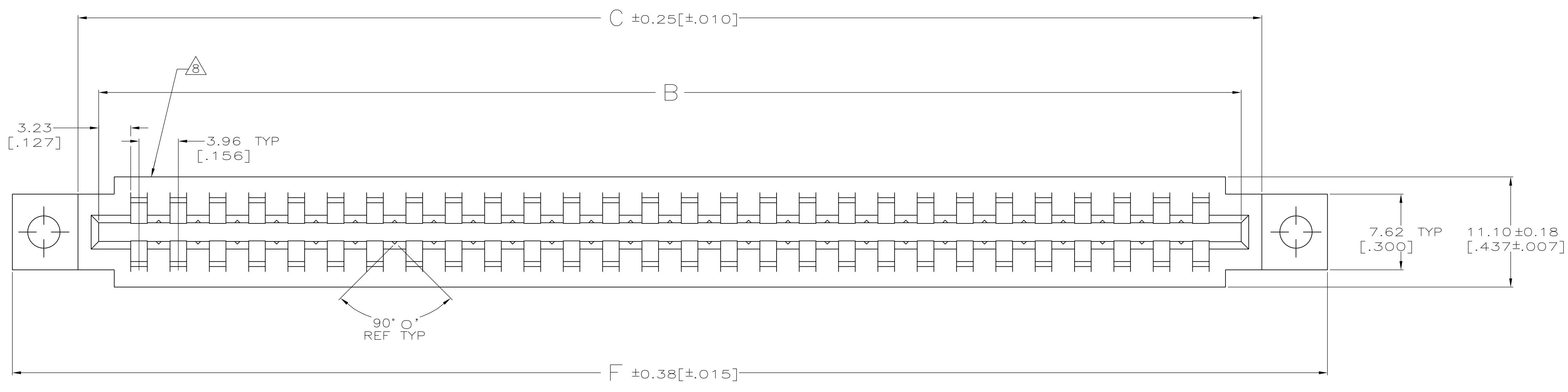
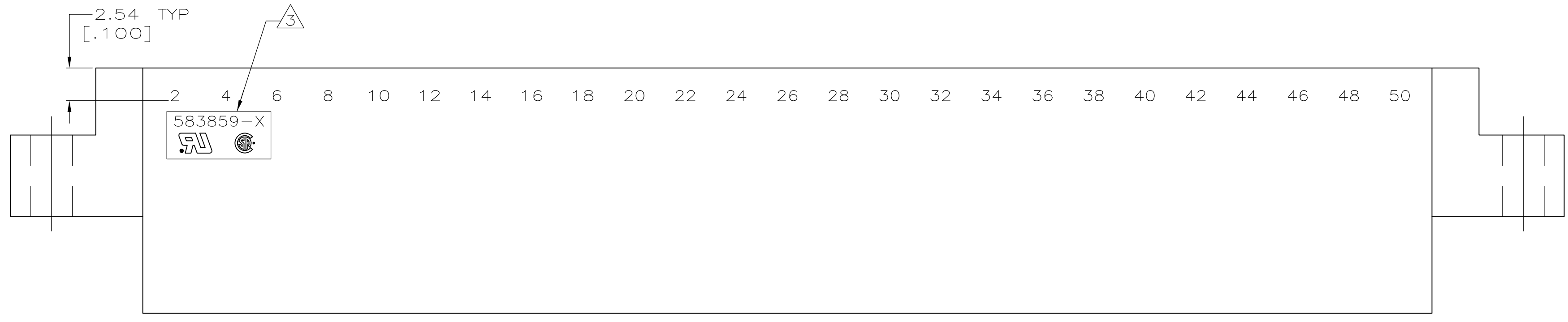

- 1 FIRST 22 POSITIONS MARKED WITH UPPER CASE LETTERS, FOLLOWED BY LOWER CASE LETTERS, FOLLOWED BY UPPERCASE AA,AB,AC ETC. CHARACTERS G,I,O AND Q ARE OMITTED. SEE TABLE FOR END CAVITY IDENTIFICATION.
- 2 PULL GROOVES OPTIONAL THESE LOCATIONS REF ONLY.
- 3 HOUSING PART NUMBER, UL & CSA LOGO'S TO BE MOLDED IN THIS AREA. UL LOGO PER 1-18838-3, CSA LOGO PER 1-18839-3.
- 4 CORING AT AMP'S OPTION REF ONLY.
- 5 HOT STAMP CUSTOMER PART NUMBER 2471-3190 IN THIS AREA FOR 1-583859-7 ONLY.
- 6 STAMPED WITH SPECIAL CAVITY IDENTIFICATION ON SIDES OF HOUSING.
- 7 $\phi 6.35 \pm 0.38 [.250 \pm 0.015]$ WHITE DOT IN LOWER LEFT HAND CORNER.
- 8 DATE CODE TO BE MOLDED IN THIS AREA

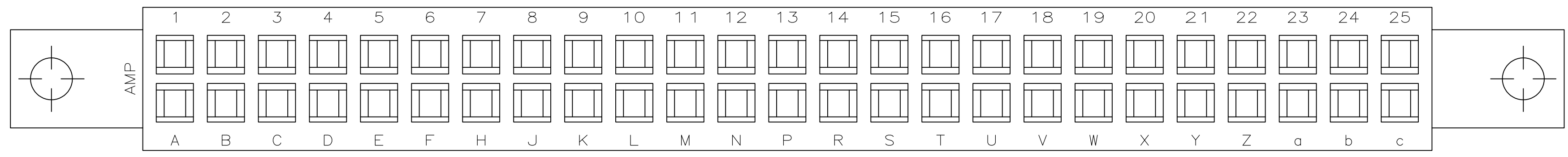

1 OBSOLETE	10 & L	.128	2.409	2.159	1.600	1.888	1.724	10	2-583859-8
OBSOLETE	14 & R	.128	3.033	2.783	2.224	2.512	2.348	14	2-583859-7
2 OBSOLETE	25 & c	.128	4.749	4.500	3.940	4.228	4.064	25	2-583859-5
	36 & r	.128	6.465	6.215	5.656	5.944	5.780	36	2-583859-3
	8 & J	.128	2.097	1.847	1.288	1.576	1.412	8	2-583859-1
OBSOLETE	24 & b	.128	4.593	4.343	3.784	4.072	3.908	24	1-583859-9
3 OBSOLETE	28 & f	.128	5.217	4.967	4.408	4.696	4.532	28	1-583859-7
	12 & N	.128	2.721	2.471	1.912	2.200	2.036	12	1-583859-5
	6 & F	.128	1.785	1.535	.976	1.264	1.100	6	1-583859-3
OBSOLETE	18 & V	.156	3.657	3.407	2.848	3.136	2.972	18	1-583859-1
	10 & L	.128	2.409	2.159	1.600	1.888	1.724	10	583859-9
	15 & S	.128	3.189	2.939	2.380	2.668	2.504	15	583859-7
	18 & V	.128	3.657	3.407	2.848	3.136	2.972	18	583859-5
	22 & Z	.128	4.281	4.031	3.472	3.760	3.596	22	583859-3
	28 & f	.128	5.217	4.967	4.408	4.696	4.532	28	583859-1
	END CAVITY IDENT								
		G	F	E	D	C	B	POSN	PART NUMBER

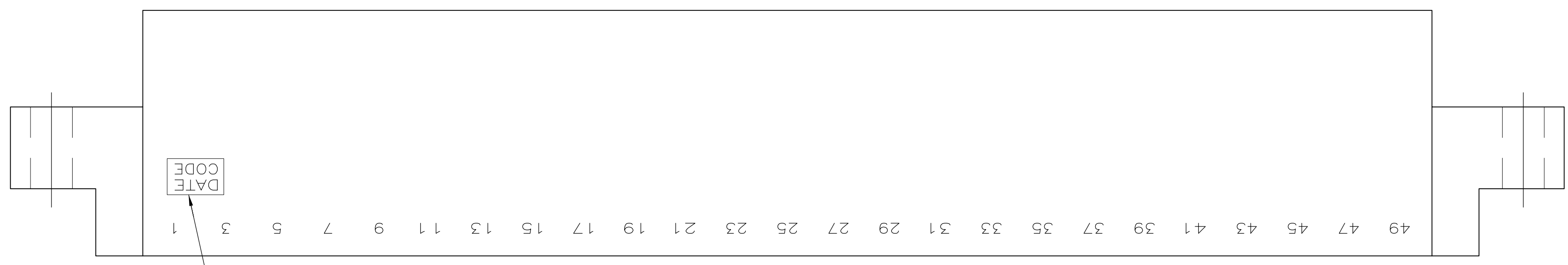

2-583859-5 ~~4~~

THIS DRAWING IS A CONTROLLED DOCUMENT.		OWN: J. GALLUCCI BC 12-10-92	PART NO	
DIMENSIONS: mm [INCHES]		CHK: H. ROSE 3/2/94	TE Connectivity	
TOLERANCES UNLESS OTHERWISE SPECIFIED:		APVD: H. ROSE 3/2/94	NAME	
0 PLC ±	1 PLC ±	PRODUCT SPEC	HOUSING, CRIMP SNAP	
2 PLC ±	3 PLC ±	APPLICATION SPEC	TWIN LEAF, .156	
4 PLC ±	ANGLES ±	WEIGHT	WITH MOUNTING EARS	
MATERIAL	FINISH	SIZE	CAGE CODE	DRAWING NO
		A1	00779	583859
CUSTOMER DRAWING		SCALE	SHEET	REV
		4:1	2 OF 2	AA2

X-ON Electronics

Largest Supplier of Electrical and Electronic Components

Click to view similar products for [Standard Card Edge Connectors](#) category:

Click to view products by [TE Connectivity](#) manufacturer:

Other Similar products are found below :

[CR7E-30DB-3.96E\(72\)](#) [6364499-1](#) [6565204-6](#) [PKC-156](#) [1437274-4](#) [147889-1](#) [1489165-4](#) [EBT15622B2X](#) [1-582587-1](#) [284-0102-12100](#)
[286-0052-12101A](#) [306022901000000](#) [307-012-502-202](#) [307-056-520-300](#) [2129318-1](#) [245-062-520-350](#) [287-0032-12101](#) [306-028-525-102](#)
[307-072-526-202](#) [345-060-559-303](#) [392-008-559-201](#) [534671-1](#) [341-240-317](#) [345-044-500-300](#) [346-240-318](#) [395-100-524-300](#) [09-07-2032](#)
[10035388-802LF](#) [10115859-011LF](#) [10122859-009LF](#) [10127905-B04B24BLF](#) [530555-1](#) [5-678046-1](#) [73726-0005](#) [66308-1](#) [1-1437275-6](#)
[PEC-07-02-T-S-A](#) [346-014-520-801](#) [307-048-502-202](#) [CE100F22-9-C](#) [CE100F26-7-C](#) [CE100F28-3-D](#) [CE156F18-9-C](#) [CE156F22-5-D](#)
[CE156F22-9-C](#) [CT100F22-2-D](#) [CT100F22-3-D](#) [CT100F24-2-D](#) [CT100F24-3-D](#) [CT100F24-6-C](#)