

THIS DRAWING IS UNPUBLISHED. RELEASED FOR PUBLICATION 20
 © COPYRIGHT 20 BY TYCO ELECTRONICS CORPORATION ALL RIGHTS RESERVED.

REVISIONS				
P	LTR	DESCRIPTION	DATE	APVD
E		REVISED PER ECO-14-016912	07NOV2014	DD JS
E1		REVISED PER ECO-16-002322	18FEB2016	DD JS

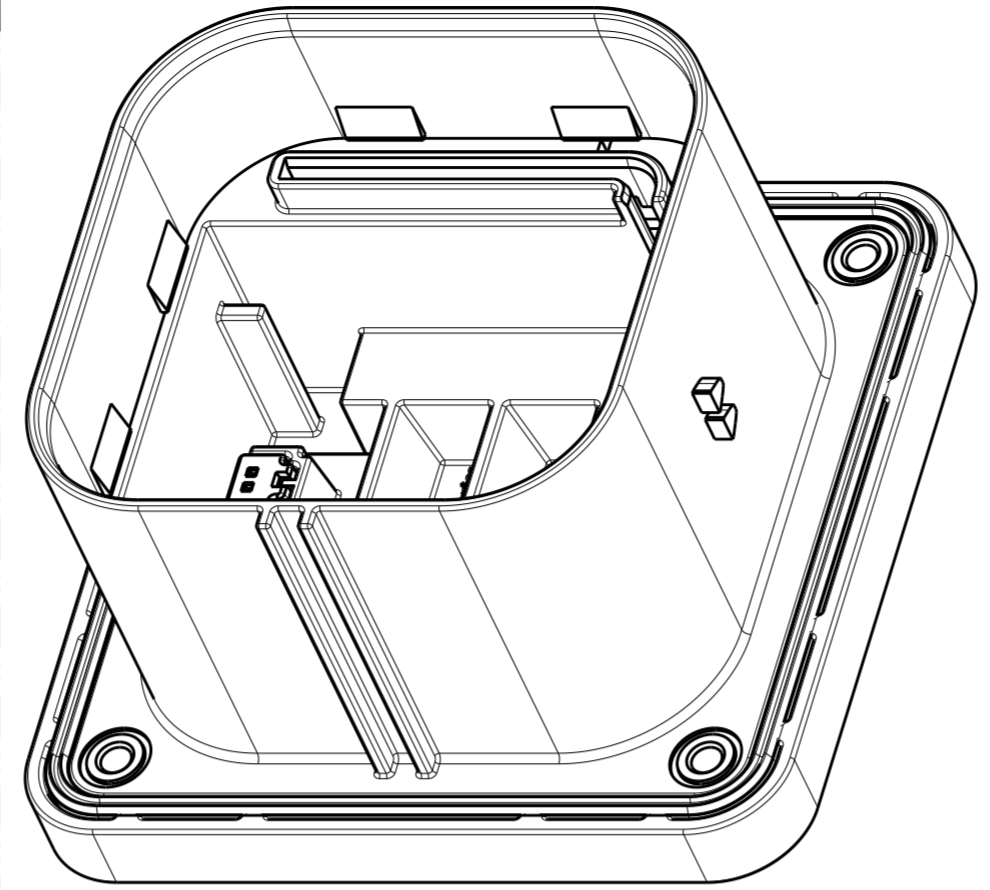

ISOMETRIC VIEW
SCALE 1:1

- 1 M6-1 THREADED STUD
TORQUE LIMITS: 10Nm±0.5Nm
- 2 M6-1 THREADED INSERT
TORQUE LIMITS: 9Nm - 11Nm

THREADED BUSHINGS (4X) HEAT STAKED FLUSH TO MAX 0.40mm DEEP FROM THIS SURFACE.
- 3 HVIL CONNECTOR RETAINING LOCATIONS
HVIL CONNECTOR:
1534112-1 (RETAINER; MQS; 2P)
1-1534113-1 (RECEPTACLE HOUSING; MQS; 2P)
HVIL CONTACT:
928999-6 (SOCKET CONTACT; MQS; Ag)
- 4 MOUNTING SURFACE THICKNESS (MAX): 6.2mm
- 5 SURFACE FINISH AND FLATNESS APPLY WITHIN BOUNDARY SHOWN.
- 6. INNER HOUSING MAY BE ASSEMBLED ROTATED 180° FROM AS SHOWN.
- 7 ASSEMBLY / WORK INSTRUCTIONS: 408-10377
- 8 NOTE DELETED
- 9 SEE SHEET 2 FOR FUSE RATING MARKINGS AND KEYING CONFIGURATIONS.
- 10 SURFACE FINISH IN MICRONS (µm)

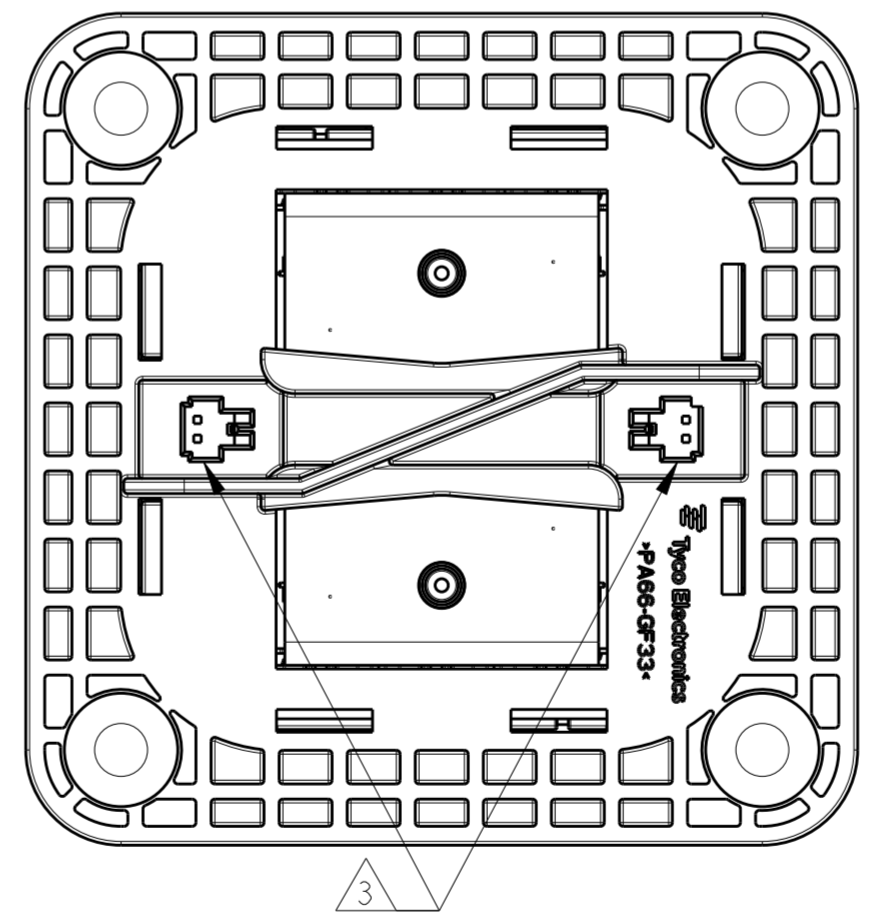
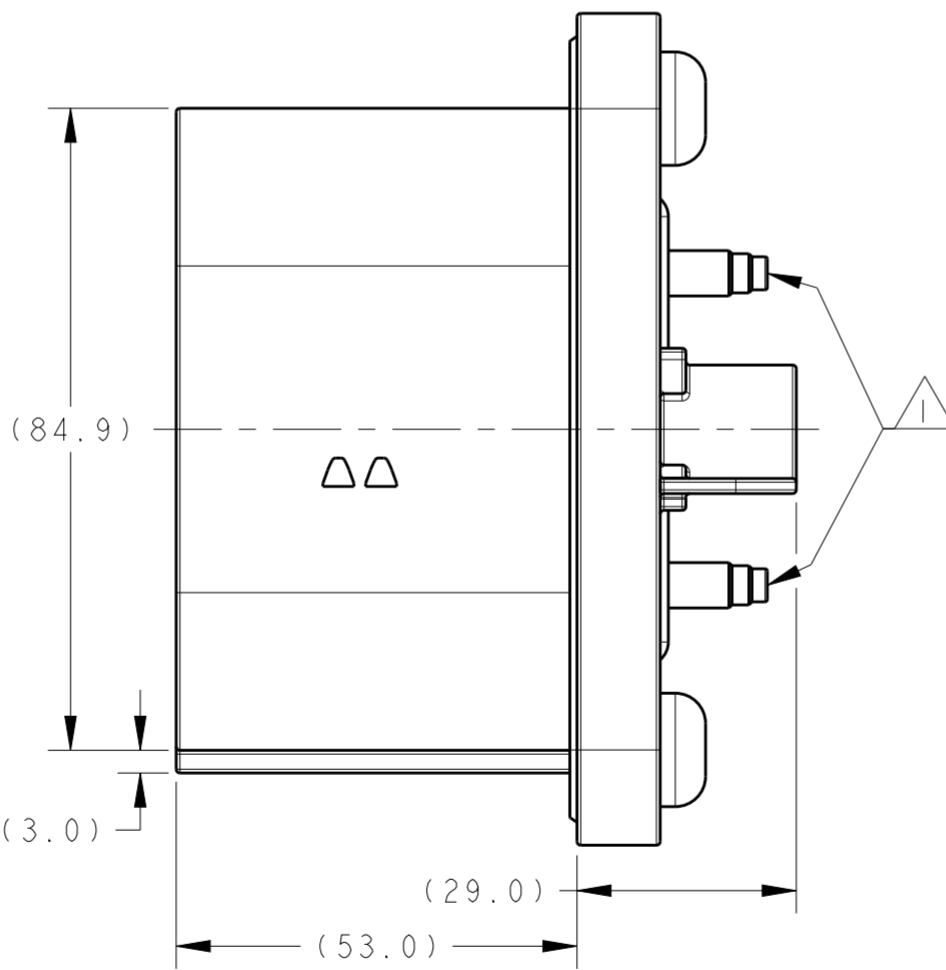
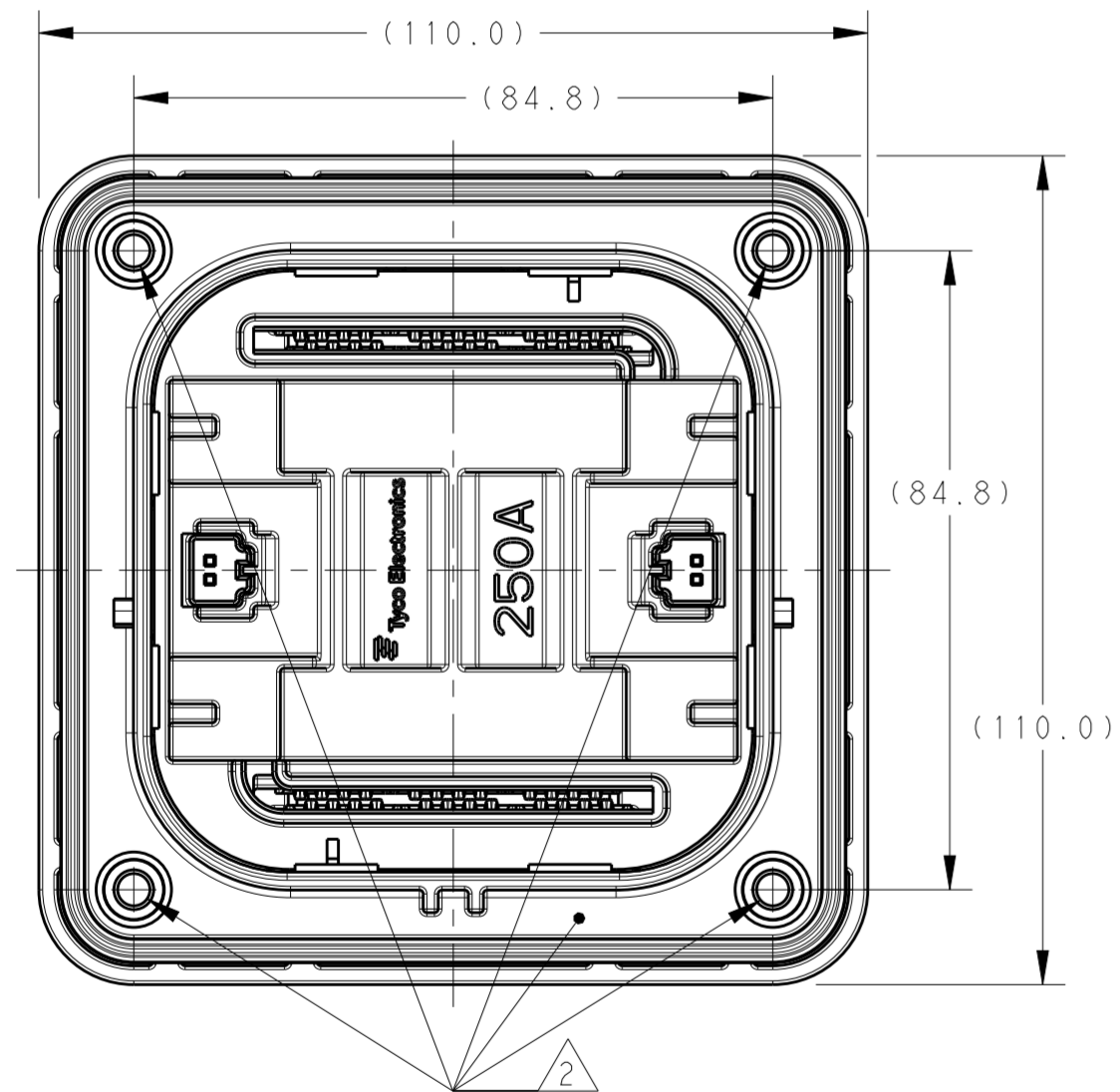

DESCRIPTION	PART NUMBER
M6 THREADED INSERT	1-1587987-7
E1 M6 THREADED INSERT (350A WITH DIVIDER NOTCH)	1-1587987-5
M6 THREADED INSERT	1-1587987-4
E1 M6 THREADED INSERT (250A WITH DIVIDER NOTCH)	1-1587987-3
M6 THREADED INSERT	1-1587987-1
M6 THREADED INSERT	1587987-9
M6 THREADED INSERT	1587987-8

THIS DRAWING IS A CONTROLLED DOCUMENT. DIMENSIONING AND TOLERANCING PER ASME Y14.5M-2009		DWN G. COITIER 10MAR2010	TE Connectivity	
DIMENSIONS: mm		CHK A. BOYER 10MAR2010		
TOLERANCES UNLESS OTHERWISE SPECIFIED:		APVD J. BOLEWITZ 10MAR2010	NAME RECEPTACLE ASSEMBLY MANUAL SERVICE DISCONNECT	
0 PLC ±	1 PLC ±	PRODUCT SPEC 108-127000	SIZE CAGE CODE DRAWING NO RESTRICTED TO	
2 PLC ±	3 PLC ±	APPLICATION SPEC	A200779 C-1587987	
4 PLC ±	ANGLES ±	WEIGHT 320.34g	SCALE 1:1 SHEET 1 OF 3 REV E1	
MATERIAL	FINISH	CUSTOMER DRAWING		

THIS DRAWING IS UNPUBLISHED. RELEASED FOR PUBLICATION
COPYRIGHT 20 BY TYCO ELECTRONICS CORPORATION ALL RIGHTS RESERVED.

REVISIONS				
P	LTR	DESCRIPTION	DATE	APVD
-	-	SEE SHEET 1	-	-

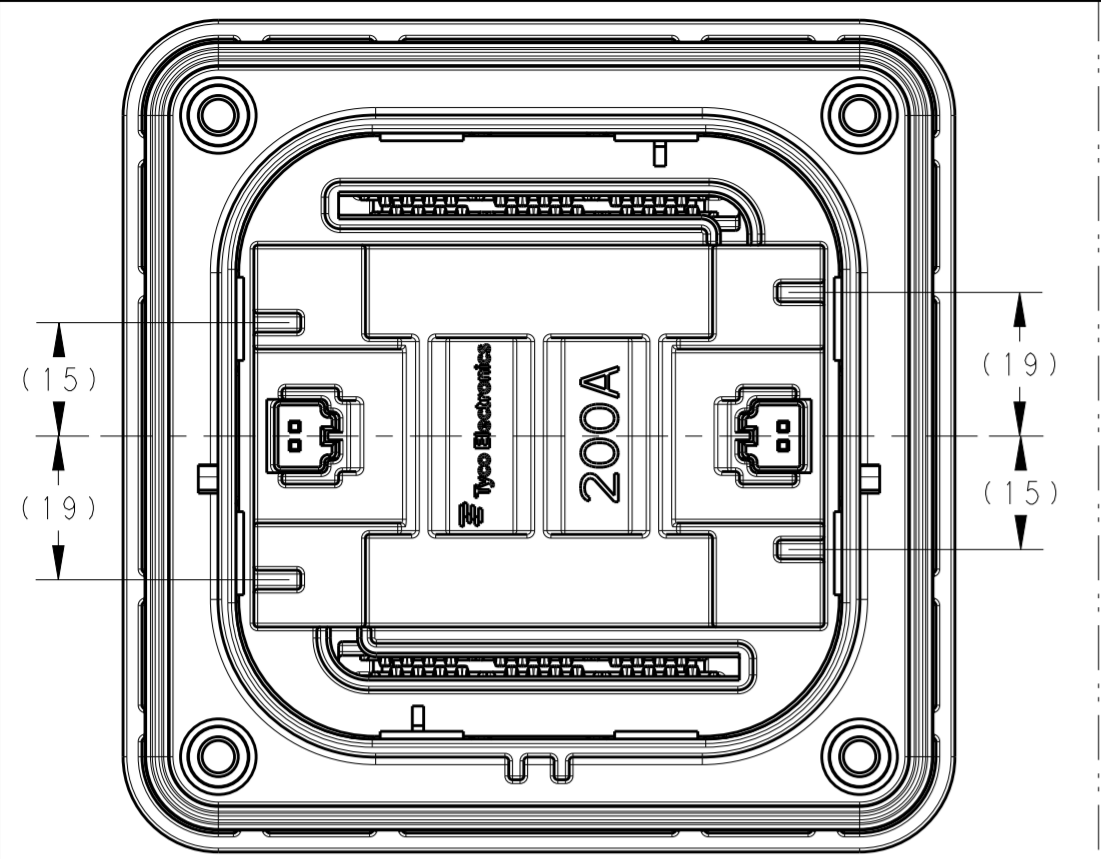

1587987-8
FUSE RATING: 200A

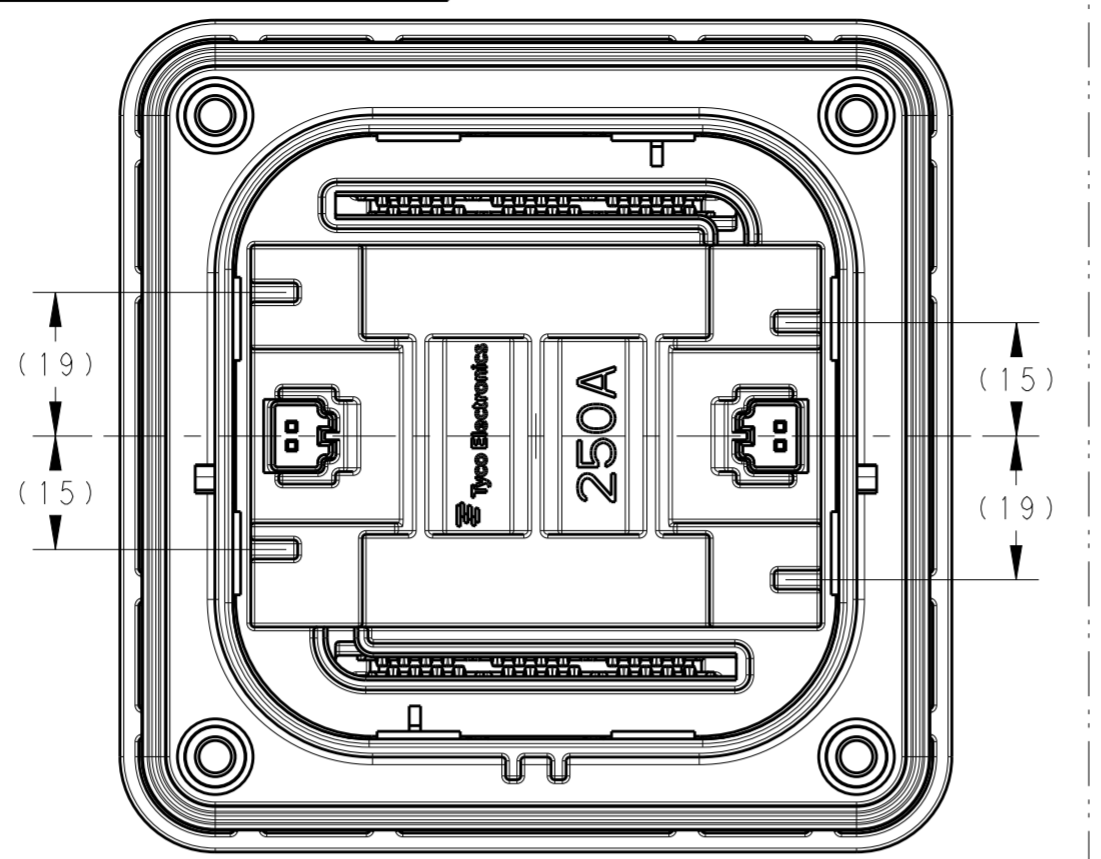

1587987-9
FUSE RATING: 250A

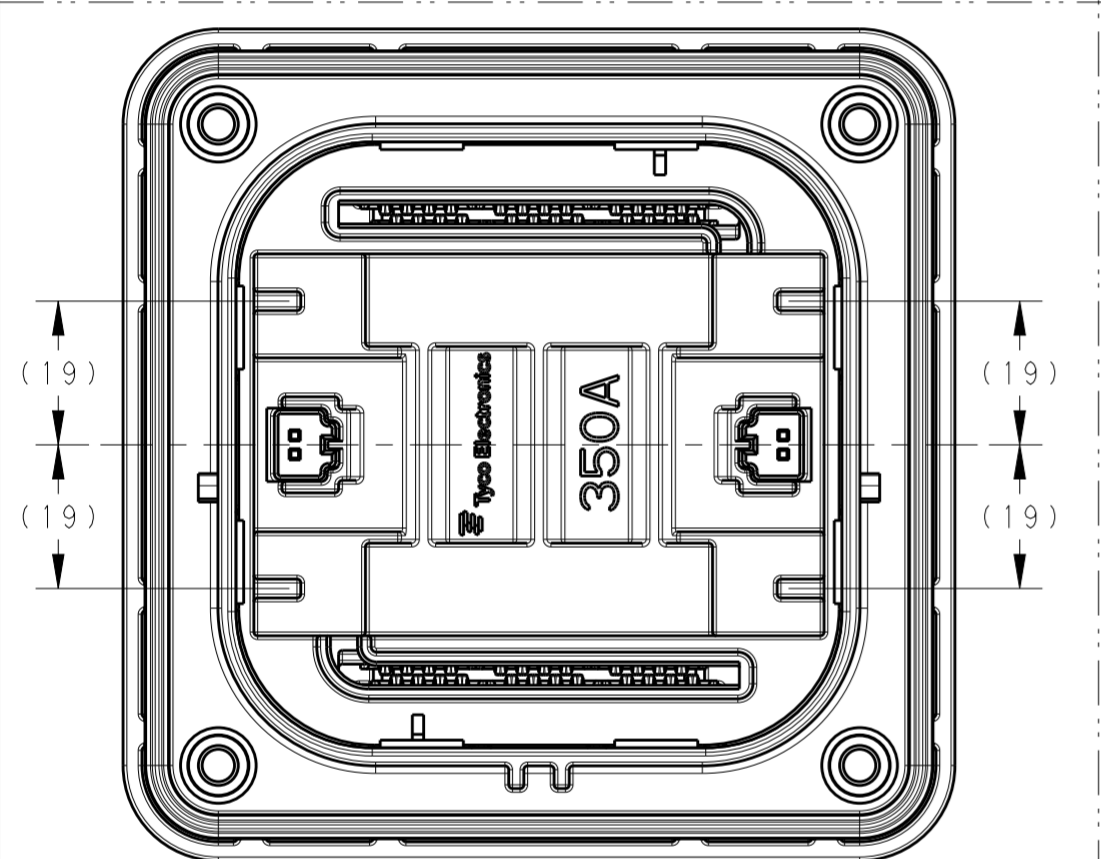

1-1587987-1
FUSE RATING: 350A

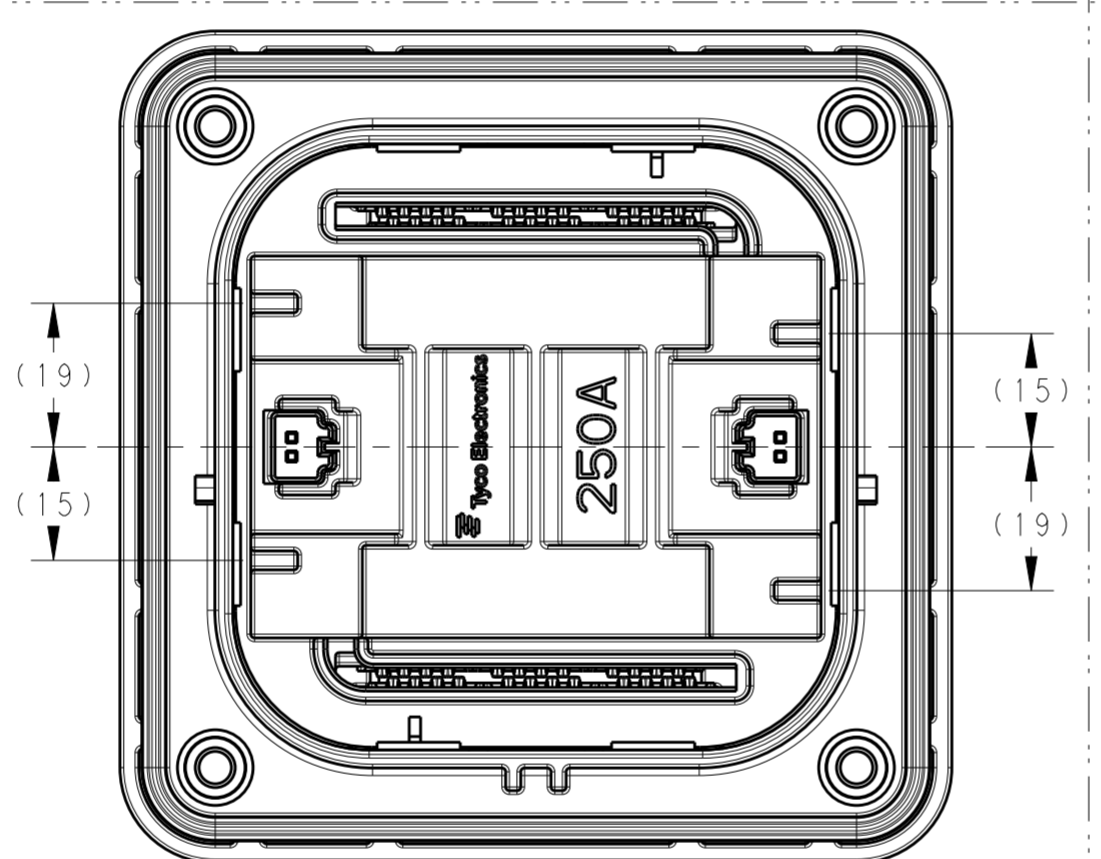

1-1587987-3
(WITH DIVIDER RIB NOTCH)
FUSE RATING: 250A

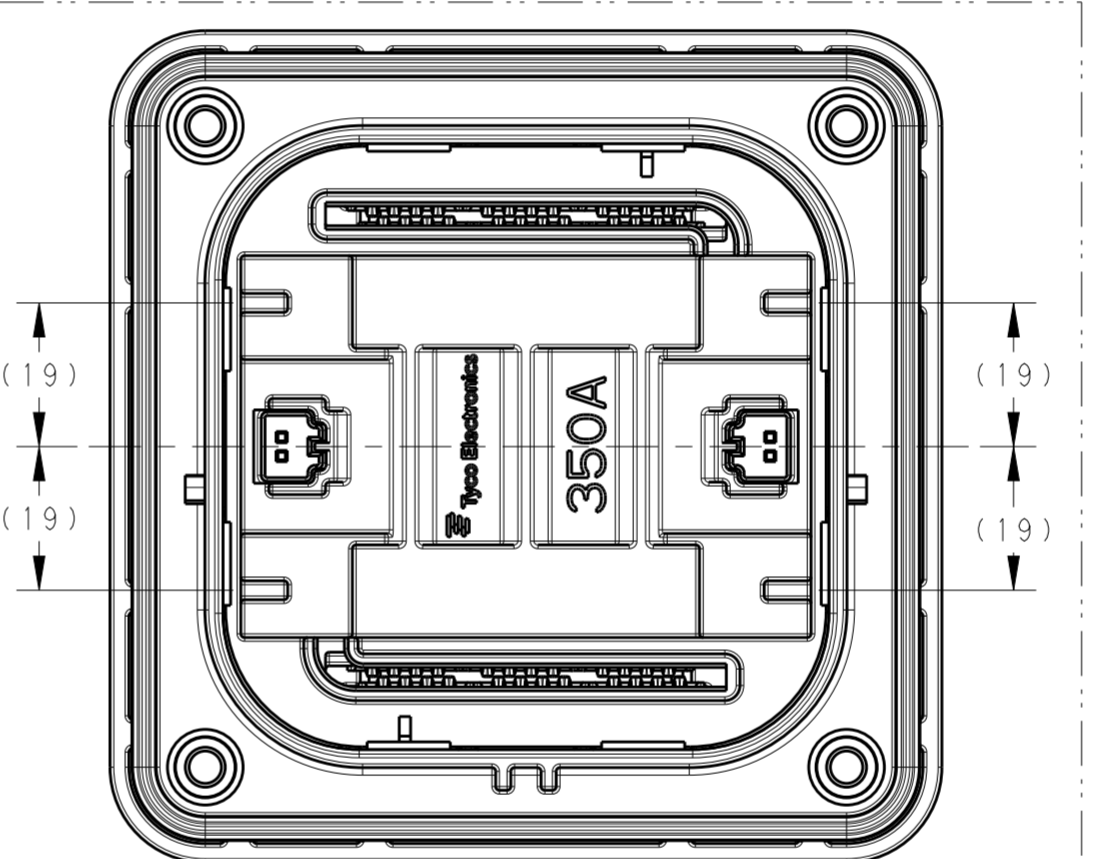

1-1587987-5
(WITH DIVIDER RIB NOTCH) **E1**
FUSE RATING: 350A

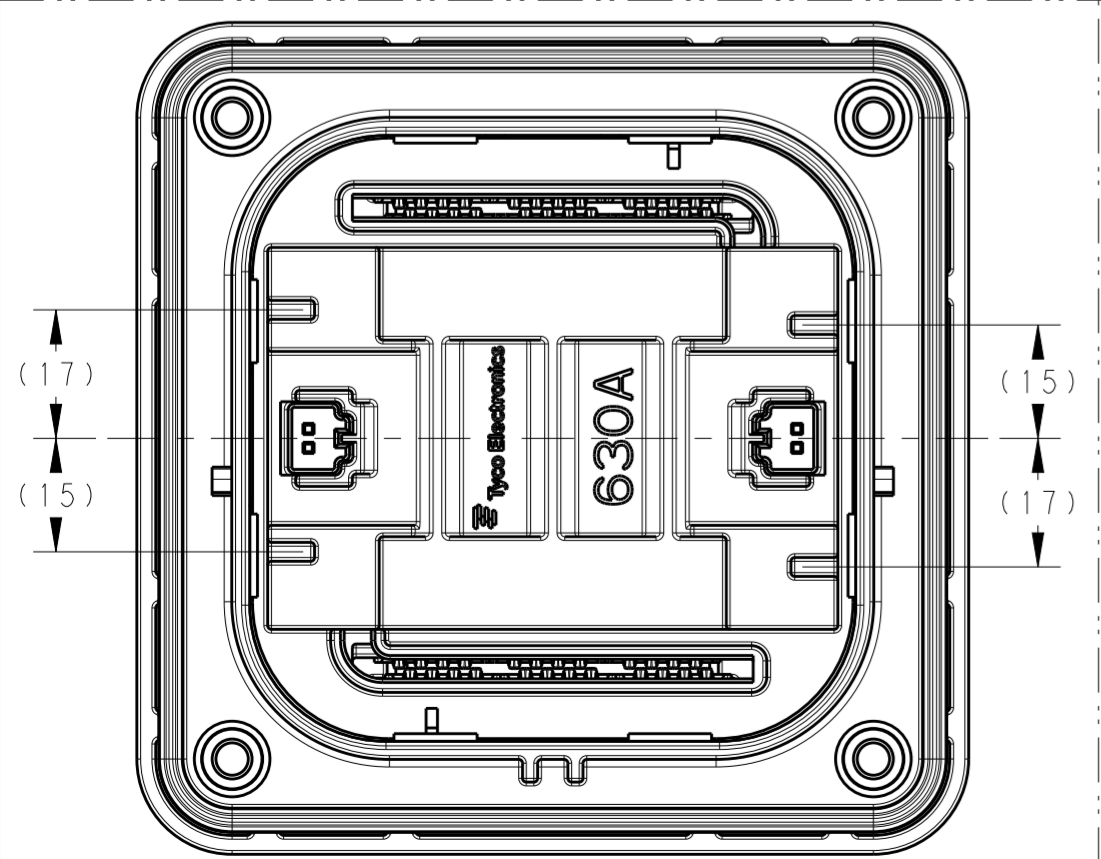

1-1587987-4
FUSE RATING: 630A

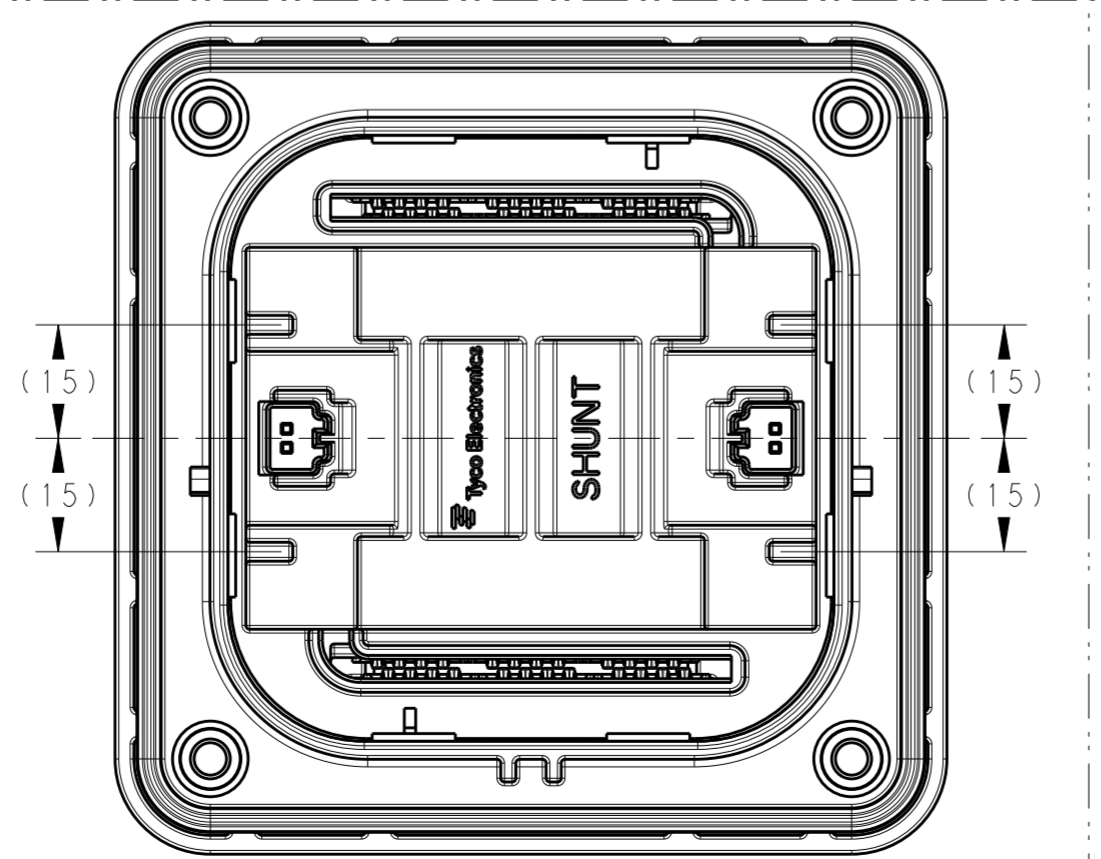

1-1587987-7
SHUNT

THIS DRAWING IS A CONTROLLED DOCUMENT. DIMENSIONING AND TOLERANCING PER ASME Y14.5M-2009		DWN G. COITIER 10MAR2010	TE Connectivity	NAME RECEPTACLE ASSEMBLY MANUAL SERVICE DISCONNECT
DIMENSIONS: mm		CHK A. BOYER 10MAR2010		
TOLERANCES UNLESS OTHERWISE SPECIFIED:		APVD J. BOLEWITZ 10MAR2010		
0 PLC ± 1 PLC ± 2 PLC ± 3 PLC ± 4 PLC ± ANGLES ± FINISH -		PRODUCT SPEC 108-127000 APPLICATION SPEC WEIGHT 320.34g		
MATERIAL		CUSTOMER DRAWING	SIZE A200779	DRAWING NO. C-1587987
SCALE 1:1			SHEET 2 OF 3	REV E1

THIS DRAWING IS UNPUBLISHED. RELEASED FOR PUBLICATION 20
 © COPYRIGHT 20 BY TYCO ELECTRONICS CORPORATION ALL RIGHTS RESERVED.

REVISIONS				
P	LTR	DESCRIPTION	DATE	APVD
-		SEE SHEET 1	-	-

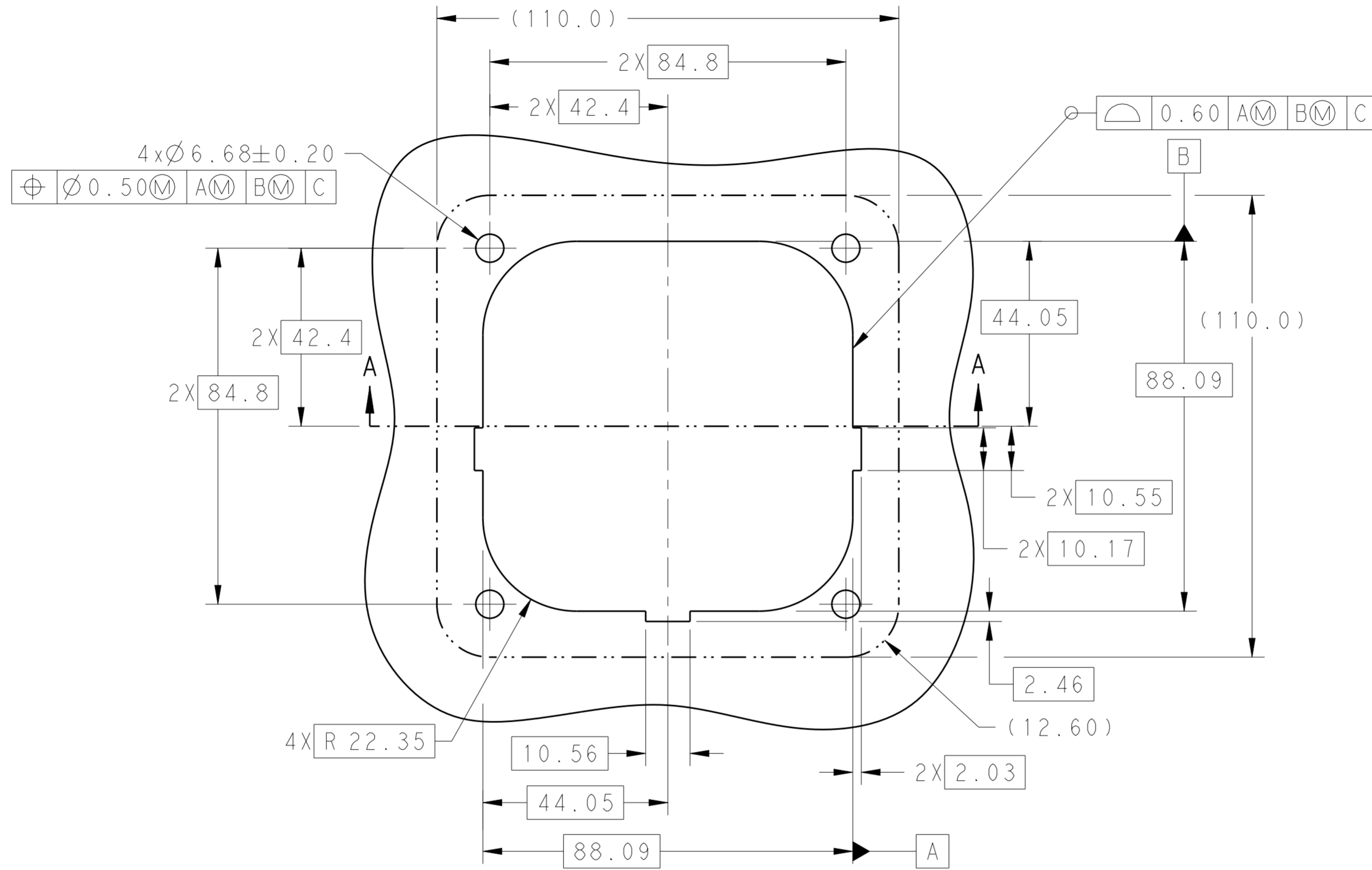

MOUNTING INTERFACE SPECIFICATION

THIS DRAWING IS A CONTROLLED DOCUMENT. DIMENSIONING AND TOLERANCING PER ASME Y14.5M-2009		DWN: G. COITER 10MAR2010 CHK: A. BOYER 10MAR2010 APVD: J. BOLEWITZ 10MAR2010	STE TE Connectivity	
DIMENSIONS: mm		PRODUCT SPEC: 108-127000	NAME: RECEPTACLE ASSEMBLY MANUAL SERVICE DISCONNECT	
TOLERANCES UNLESS OTHERWISE SPECIFIED: 0 PLC ± 1 PLC ± 2 PLC ± 3 PLC ± 4 PLC ± ANGLES ± FINISH		APPLICATION SPEC: 7	SIZE: A200779	DRAWING NO: C-1587987
MATERIAL: -		WEIGHT: 320.34g	RESTRICTED TO: -	SCALE: 1:1
		CUSTOMER DRAWING	SHEET: 3 OF 3	REV: E1

X-ON Electronics

Largest Supplier of Electrical and Electronic Components

Click to view similar products for [Automotive Connectors](#) category:

Click to view products by [TE Connectivity](#) manufacturer:

Other Similar products are found below :

[003-018-000](#) [60403001](#) [60993906-B](#) [M902-2131](#) [M902-2161](#) [72.330.1035.1](#) [73.353.4028.0](#) [F119300-B](#) [F166900](#) [F258300-B](#) [F358300-B](#)
[F407400](#) [F444110](#) [F487000](#) [F509500B-B](#) [827153-1](#) [8N1515-32-24P](#) [9-1326729-8](#) [925474-1](#) [928905-1](#) [964562-4](#) [968782-1](#) [GT17SA-8DS-](#)
[HU](#) [98891-1012](#) [98947-1016](#) [12004147](#) [12004475-L](#) [12010290](#) [12010309-B](#) [12015454](#) [12020219-B](#) [12020308](#) [12041318-B](#) [12052225-L](#)
[12052466](#) [12059125](#) [12064869](#) [12004327-B](#) [12010503-B](#) [12015308](#) [12015384](#) [12015909](#) [1-21030-1](#) [12041254](#) [12041318](#) [12047946-B](#)
[12047957](#) [12047957-L](#) [12059473](#) [12066261](#)