

SCALA NON IMPEGNATIVA
(DO NOT SCALE)
DIMENSIONI IN mm
(DIMENSIONS IN mm)

METRIC

PROIEZIONE EUROPEA
(EUROPEAN PROJECTION)

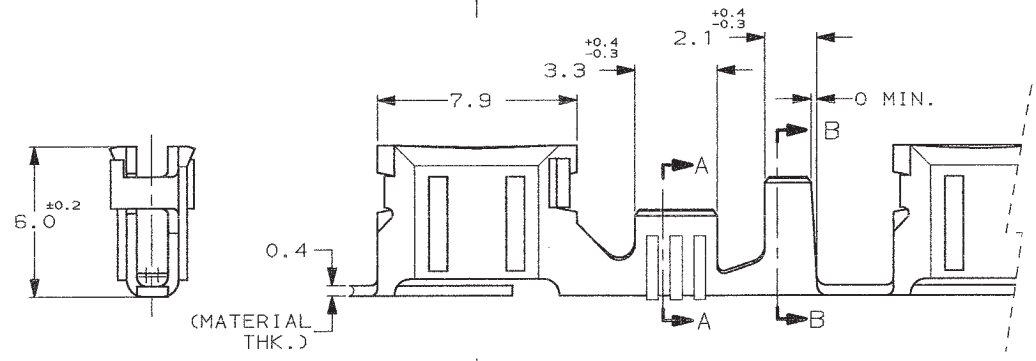
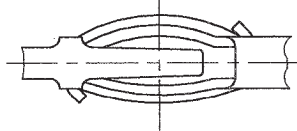
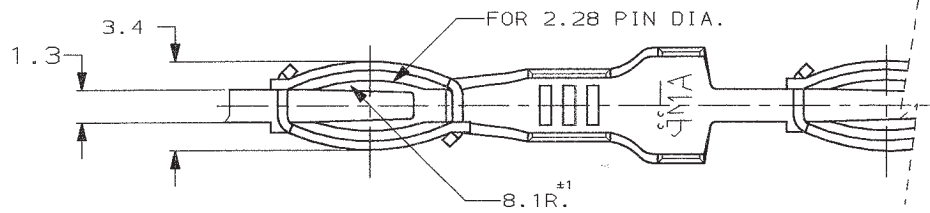

SEZIONE A-A
(SECTION A-A)

SEZIONE B-B
(SECTION B-B)

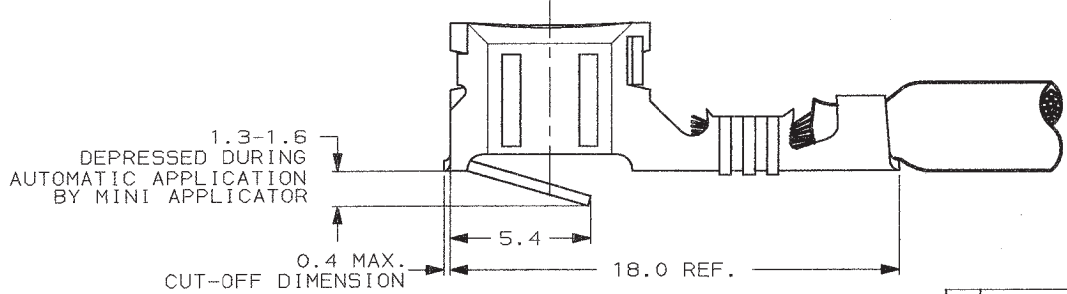
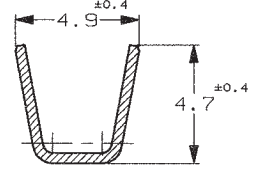
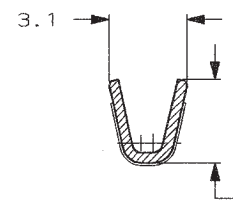

1) STATO DI FORNITURA -SCALA 1:1-
(SUPPLY CONDITION -SCALE 1:1-)

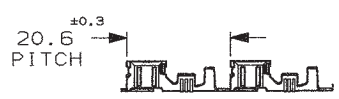

SENSO DI USCITA
DEL TERMINALE
DALLA BOBINA
(DIRECTION OFF
TOP OF REEL)

2) CONFEZIONATO IN ACCORDO ALLA AMP SPEC. 107-20211.
(PACKAGING ACCORDING TO AMP SPEC. 107-20211).

3) REELED WITH INTERLEAVE PAPER.

STAGNATO (TIN PLATED)	BRONZO FOSF. (PH. BRONZE)	0-160640-2	Z
NUDO (UNPLATED)	BRONZO FOSF. (PH. BRONZE)	0-160640-1	Z
FINITURA / COLORE (FINISH / COLOUR)	MATERIALE (MATERIAL)	NUMERO (AMP P/N)	REV

CUSTOMER DWG. FOR REFERENCE ONLY DISEGNO PER CLIENTE SOLO PER RIFERIMENTO

THIS DRAWING IS UNPUBLISHED RELEASE FOR PUBLICATION 19
© COPYRIGHT 19 BY AMP INCORPORATED, HARRISBURG, PA. ALL INTERNATIONAL RIGHT RESERVED. AMP PRODUCTS MAY BE COVERED BY U.S. AND FOREIGN PATENT AND/OR PATENT PENDING

TOLLERANZE, SE NON DIVERSAMENTE SPECIFICATO (TOLERANCES, UNLESS OTHERWISE SPECIFIED)	DIAM. ISOLANTE (INS. DIA. RANGE) mm	RANGO FILO (WIRE RANGE) (O.B. = 1.5 mm ²)	SCALA (SCALE)
± 0.3	3.4-4.1	18-16 AWG	5:1

ANGOLI (ANGLES) ± 2°

DIS. H. YAALI (COR.) 11 JAN 2000



DESCRIZIONE (DESCRIPTION)
SNAP-IN CLUSTER REC. CONTACT

Z1	REVISED PER ECR-19-015041	PC	07NOV 2010	CONT. C. TARTARI	LOC. SIZE	NUMERO (DWG NO)	REV.	FOGLIO (SHEET)
Z	REVISED & REDRAWN ETOQ-0407-99	H. Y	13JAN 2000	APP. 11 JAN 2000	IA3	C-160640	Z1	1 OF 1
REV. (REV.)	REVISIONI (REVISION RECORD)	DIS. (DR)	DATA (DATE)	APP. (APP.)				

DISTRIBUZIONE (PRINT-DIST.)

X-ON Electronics

Largest Supplier of Electrical and Electronic Components

Click to view similar products for [Terminals](#) category:

Click to view products by [TE Connectivity](#) manufacturer:

Other Similar products are found below :

[00-054007-01074-6](#) [00-054007-70206-1](#) [00-054007-70210-8](#) [00-054007-70217-7](#) [00-054007-70226-9](#) [00-054007-70228-3](#) [00-054007-70248-1](#) [00-054007-70256-6](#) [00-054007-70301-3](#) [00-054007-70316-7](#) [00-054007-49560-4](#) [00-054007-70209-2](#) [00-054007-70225-2](#) [00-054007-70227-6](#) [00-054007-70231-3](#) [00-054007-70241-2](#) [00-054007-70242-9](#) [00-054007-70244-3](#) [00-054007-70246-7](#) [00-054007-70263-4](#) [00-054007-70288-7](#) [00-054007-70290-0](#) [00-054007-70300-6](#) [00-054007-70304-4](#) [01-2065-1-0216](#) [01-2900-1-04412](#) [00581P0075](#) [600TS-10](#) [60205-1](#) [604200-1](#) [605601-1](#) [60598-1-CUT-TAPE](#) [61314-6-C](#) [61810-3](#) [61-S](#) [61-SN](#) [626-0194](#) [62-NBM-A](#) [62-SN](#) [62-SP](#) [63-S](#) [640179-1](#) [M55155/059I03](#) [M55155/079C01](#) [M55155/099H02](#) [M55155/109H01](#) [M55155/109H02](#) [M55155/12XH05](#) [M55155/16XH02](#) [M55155/29-5S](#)