

DO NOT SCALE  
DIMENSIONS IN mm

METRIC

THIRD ANGLE  
PROJECTION

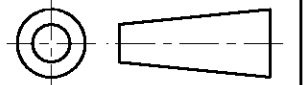

NOTES

- 1. FOR USE ON MINIATURE APPLICATORS ( LEFT-RIGHT FEED ) AND STANDARD APPLICATORS ( RIGHT-LEFT FEED ).
- 2. REELED WITH PAPER AND PAPER COVER.
- 3. OBSOLETE PARTS: OBSOLETE CIS STREAMLINING PER D.RENAUD/D.SINISI

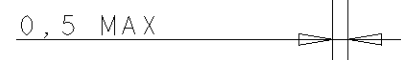
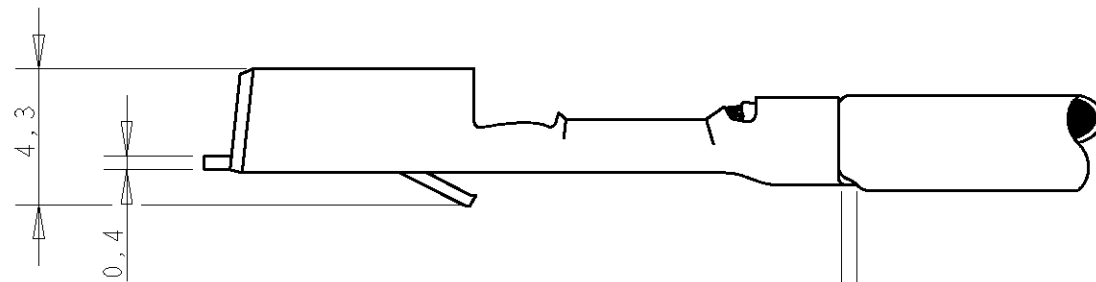
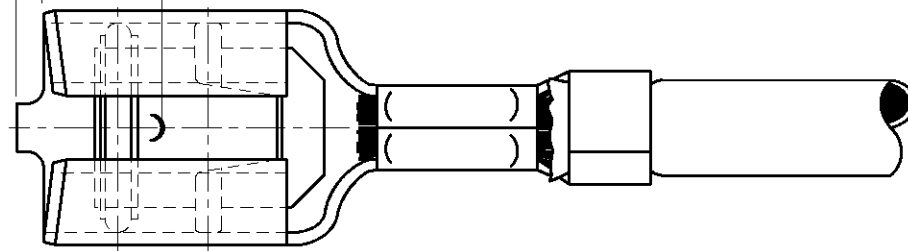
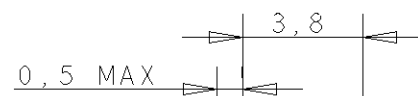
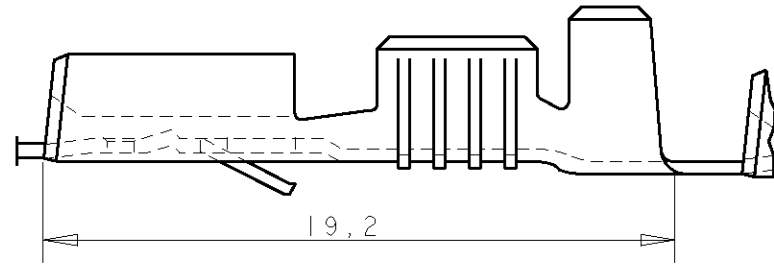
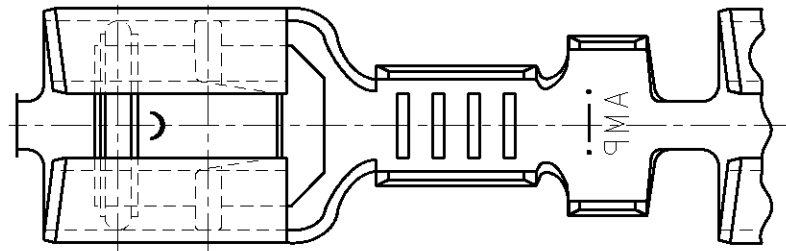
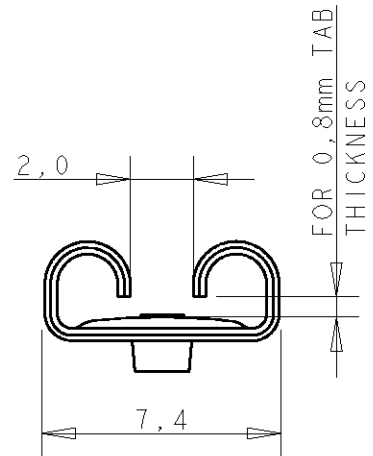

WIRE RANGE :  
>1,0-2,5 mm<sup>2</sup>  
INSULATION RANGE :  
2,1-3,1 DIA.

GENERAL TOLERANCES ±0.3

NOTES	FINISH	MATERIAL	PARTNUMBER
OBSOLETE 3	PRE-TINPLATED	PH.BRONZE	<del>6-160917-8</del>
	PRE-TINPLATED	BRASS	<del>6-160917-7</del>
	TINPLATED	PH.BRONZE	160917-4
	UNPLATED	PH.BRONZE	160917-3
	TINPLATED	BRASS	160917-2
	UNPLATED	BRASS	160917-1

DR.	CHK.	APP.	DATE	REV.	DATE	DATE	DATE	DWG. No.	REV. LTR.	SHEET	OF		
R.V.LOKVEN.	A.BIJNEN.	L.V.SOEST.	31-07-87		10-08-87	25-08-887		160917	E3	1	1		
E3 REVISED PER ECO-11-005139				RK	HMR	28MAR11							
LTR. REVISION RECORD				DR.	CHK.	DATE							
CUSTOMER DRAWING FOR REFERENCE ONLY WILL NOT BE UPDATED													
THIS DRAWING IS UNPUBLISHED - RELEASED FOR PUBLICATION JULY, 19 87													
TE Connectivity NAME .250 SRS FASTIN-ON RECEPTACLE.													
DWG. No. 160917									REV. LTR. E3			SHEET 1 OF 1	

## X-ON Electronics

Largest Supplier of Electrical and Electronic Components

*Click to view similar products for [Terminals](#) category:*

*Click to view products by [TE Connectivity](#) manufacturer:*

Other Similar products are found below :

[00-054007-01074-6](#) [00-054007-70206-1](#) [00-054007-70210-8](#) [00-054007-70217-7](#) [00-054007-70226-9](#) [00-054007-70228-3](#) [00-054007-70248-1](#) [00-054007-70256-6](#) [00-054007-70301-3](#) [00-054007-70316-7](#) [0-0320562-0](#) [00-054007-49560-4](#) [00-054007-70209-2](#) [00-054007-70225-2](#) [00-054007-70227-6](#) [00-054007-70231-3](#) [00-054007-70241-2](#) [00-054007-70242-9](#) [00-054007-70244-3](#) [00-054007-70246-7](#) [00-054007-70263-4](#) [00-054007-70288-7](#) [00-054007-70290-0](#) [00-054007-70300-6](#) [00-054007-70304-4](#) [01-2065-1-0216](#) [01-2900-1-04412](#) [00581P0075](#) [600TS-10](#) [60205-1](#) [604200-1](#) [605601-1](#) [60598-1-CUT-TAPE](#) [61314-6-C](#) [61810-3](#) [61-S](#) [61-SN](#) [626-0194](#) [62-NBM-A](#) [62-SN](#) [62-SP](#) [63-S](#) [640179-1](#) [M55155/059I03](#) [M55155/079C01](#) [M55155/099H02](#) [M55155/109H01](#) [M55155/109H02](#) [M55155/12XH05](#) [M55155/16XH02](#)