

Type CRG Series

Key Features

Thick Film Resistors with high power to size ratio, ideally suited to industrial and general purpose use

Value range from 1Ω to 10MΩ

Eight package sizes

Terminal finish matte Sn over Ni



The resistive element is screen printed and fired, and a passivation layer added. Each resistor is trimmed to tolerance by laser. The pre-scribed tile is then broke into strips, the end plating fired on, and the strips broken into individual components. Final termination finish is electroplated matte Sn over a Ni barrier layer.

Electrical Characteristics

Type	0201	0402	0603	0805	1206	1210	2010	2512
Power rating (W)	0.05	0.0625	0.1	0.125	0.25	0.5	0.75W	1W
Resistance range (Ω)	Min	1R0	1R0	1R0	1R0	1R0	1R0	1R0
	Max	10M	10M	10M	10M	10M	10M	10M
Tolerance (%)	1	1	1	1	1	1	1	1
Code Letter	F	F	F	F	F	F	F	F
Max Working Voltage	25V	50V	75V	150V	200V	200V	200V	200V
Max Overload Voltage	50V	100V	150V	300V	400V	500V	500V	500V
Dielectric Strength (V)	-	100V	300V	500V	500V	500V	500V	500V
Rated current (Jumper) (A)	0.5A	1A	1A	2A	2A	2A	2A	2A
Max Overload Current (A) (Jumper)	1A	2A	2A	5A	10A	10A	10A	10A
Temperature Range	-55°C ~ 155°C							

Power rating:

Resistors shall have a power rating based on continuous load operation at an ambient temperature of 70 °C . For temperature in excess of 70 °C , The load shall be derate as shown below

Derating Chart

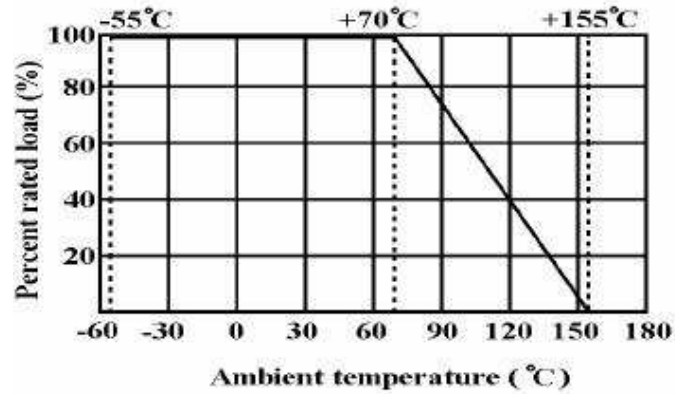

Construction

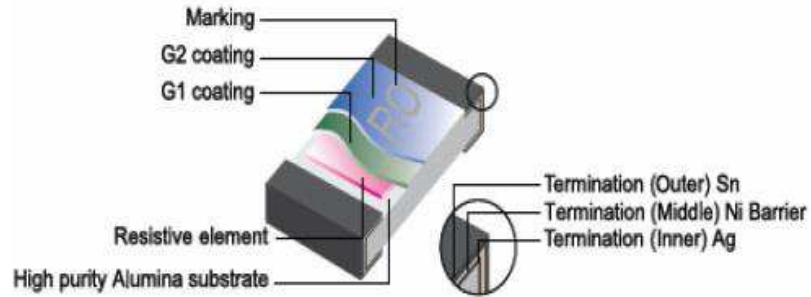

Dimensions:

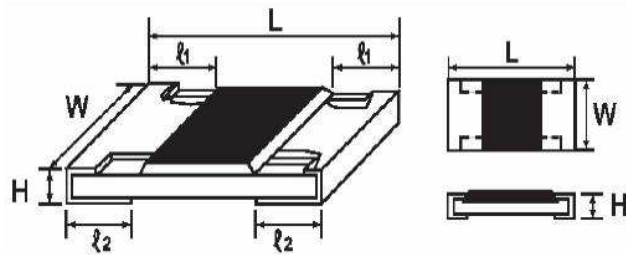

Type	Dimensions (mm)				
	L	W	H	l 1	l 2
0201	0.60±0.03	0.30±0.03	0.23±0.03	0.10±0.05	0.15±0.05
0402	1.00±0.10	0.50±0.05	0.35±0.05	0.20±0.10	0.25±0.10
0603	1.60±0.10	0.80+0.15 -0.10	0.45±0.10	0.30±0.20	0.30±0.20
0805	2.00±0.15	1.25+0.15 -0.10	0.55±0.10	0.40±0.20	0.40±0.20
1206	3.10±0.15	1.55+0.15 -0.10	0.55±0.10	0.45±0.20	0.45±0.20
1210	3.10±0.10	2.60±0.15	0.55±0.10	0.50±0.25	0.50±0.20
2010	5.00±0.10	2.50±0.15	0.55±0.10	0.60±0.25	0.50±0.20
2512	6.35±0.10	3.20±0.15	0.55±0.10	0.60±0.25	0.50±0.20

Performance Specification:

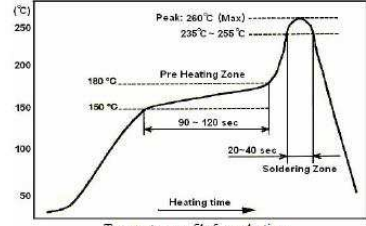
Characteristic	Specification	Test Methods (JIS C 5201-1)
*Insulation Resistance	1,000MΩ Min.	Apply 500V DC between protective coating and termination for 1 min, then measure (Sub-clause 4.6)
*Dielectric Withstanding Voltage	No evidence of flashover mechanical damage, arcing or insulation break down	Apply 100V(0402) 300V(0603) & 500V (0805,1206,1210,2010,2512) AC between protective coating and termination for 1 minute (Sub-clause 4.7)
Temperature Coefficient of Resistance (TCR)	1Ω-10Ω : ± 400 PPM/°C 10.1Ω-100Ω : ± 200 PPM/°C 101Ω~10MΩ : ± 100 PPM/°C For 0201: >100Ω : ± 200 PPM/°C	Natural resistance change per temp. degree centigrade. $\frac{R_2 - R_1}{R_1(t_2 - t_1)} \times 10^6 \text{ (PPM/°C)}$ R1: Resistance value at room temperature (t1) R2: Resistance value at room temp. plus 100 °C (t2) (Sub-clause 4.8)
Short Term Overload	Resistance change rate is: ± 5% (2.0% + 0.1Ω) Max. ± 1% (1.0% + 0.1Ω) Max.	Permanent resistance change after the application of a potential of 2.5 times RCWV for 5 seconds (Sub-clause 4.13)
*Solderability	95 % coverage Min.	Test temperature of solder : 245 ±3°C Dipping time solder : 2-3 seconds (Sub-clause 4.17)
Soldering Temp. Reference	Electrical characteristics shall be satisfied without distinct deformation in appearance. (95 % coverage Min.)	Wave soldering condition: (2 cycles Max.) Pre-heat : 100 ~ 120 °C, 30 ± 5 sec. Suggestion solder temp.: 235 ~ 255 °C, 10 sec. (Max.) Peak temp.: 260 °C Reflow soldering condition: (2 cycles Max.) Pre-heat : 150 ~ 180 °C, 90 ~ 120 sec. Suggestion solder temp.: 235 ~ 255 °C, 20 ~ 40 sec. Peak temp.: 260 °C  Hand soldering condition: The soldering iron tip temperature should be less than 300°C and maximum contract time should be 5 sec.
Soldering Heat	Resistance change rate is: ±(1%+0.05Ω) Max.	Dip the resistor into a solder bath having a temperature of 260°C±3°C and hold it for 10±1 seconds. (Sub-clause 4.18)

Performance Specification: (Continued)

Characteristic	Specification	Test Methods (JIS C 5201-1)															
Temperature Cycling	Resistance change rate is $\pm 5\%$ (1.0% + 0.05 Ω) Max. $\pm 1\%$ (0.5% + 0.05 Ω) Max.	Resistance change after continuous 5 cycles for duty cycle specified below :															
		<table border="1"> <thead> <tr> <th>Step</th> <th>Temperature</th> <th>Time</th> </tr> </thead> <tbody> <tr> <td>1</td> <td>-55°C\pm3°C</td> <td>30 mins</td> </tr> <tr> <td>2</td> <td>Room Temp</td> <td>10~15 mins</td> </tr> <tr> <td>3</td> <td>155°C\pm2°C</td> <td>30 mins</td> </tr> <tr> <td>4</td> <td>Room Temp</td> <td>10~15 mins</td> </tr> </tbody> </table>	Step	Temperature	Time	1	-55°C \pm 3°C	30 mins	2	Room Temp	10~15 mins	3	155°C \pm 2°C	30 mins	4	Room Temp	10~15 mins
		Step	Temperature	Time													
		1	-55°C \pm 3°C	30 mins													
		2	Room Temp	10~15 mins													
3	155°C \pm 2°C	30 mins															
4	Room Temp	10~15 mins															
(Sub-clause 4.19)																	
Load Life in Humidity	Resistance change rate is $\pm 5\%$ (3.0% + 0.1 Ω) Max. $\pm 1\%$ (1.0% + 0.1 Ω) Max.	Resistance change after 1,000 hours (1.5 hours "on", 0.5 hour "off") at RCWV in a humidity chamber controlled at 40°C \pm 2°C and 90 to 95 % relative humidity (Sub-clause 4.24.2.1)															
Load Life	Resistance change rate is $\pm 5\%$ (3.0% + 0.1 Ω) Max. $\pm 1\%$ (1.0% + 0.1 Ω) Max.	Permanent resistance change after 1,000 hours operating at RCWV, with duty cycle of (1.5 hours "on", 0.5 hour "off") at 70°C \pm 2°C ambient (Sub-clause 4.25.1)															
Terminal Bending	Resistance change rate is $\pm (1.0\% + 0.05\Omega)$ Max.	Twist of Test Board : Y/X = 5/90 mm for 10 seconds (Sub-clause 4.33)															
The resistors of 0 Ω only can do the characteristic noted of *																	

Environment Related Substance

This product complies to EU RoHS directive, EU PAHs directive, EU PFOS directive and Halogen free. Ozone layer depleting substances are not used in our manufacturing process of this product.

This product is not manufactured using Chloro fluorocarbons (CFCs), Hydrochlorofluorocarbons (HCFCs), Hydrobromofluorocarbons (HBFCs) or other ozone depleting substances in any phase of the manufacturing process.

Storage Condition

The performance of these products, including the solderability, is guaranteed for a year from the date of arrival at your company, provided that they remain packed as they were when delivered and stored at a temperature of 25°C \pm 10°C and a relative humidity of 60%RH \pm 10%RH, chemical and dust free atmosphere

Even within the above guarantee periods, do not store these products in the following conditions otherwise, their electrical performance and/or solderability may be deteriorated, and the packaging materials (e.g. taping materials) may be deformed or deteriorated, resulting in mounting failures.

1. In salty air or in air with a high concentration of corrosive gas, such as Cl₂, H₂S, NH₃, SO₂, or NO₂
2. In direct sunlight

Marking

E24 series 0603 – 2512 3 Digits – first two digits denote significant figures of resistance and third digit denotes number of zeros thereafter. EG

$$\begin{array}{|c|c|c|} \hline & 222 & \\ \hline \end{array} = 2K2$$

Marking for E96 Series 0805 – 2512 4 digits – First three digits denote significant figures of resistance and fourth digit denotes number of zeros thereafter. EG.

$$\begin{array}{|c|c|c|c|} \hline & 1000 & & \\ \hline \end{array} = 100R$$

For ohmic values below 100R letter “R” denotes decimal point. EG

$$\begin{array}{|c|c|c|} \hline & 1R80 & \\ \hline \end{array} = 1R8 / 1.8\Omega$$

0201 and 0402 size chips are not marked

0603 E96 3 digit marking.

Resistance Code from table on next page, and Multiplier code from table below

Multiplier Code

Code	A	B	C	D	E	F	G	H	X	Y	Z
Mult.	10 ⁰	10 ¹	10 ²	10 ³	10 ⁴	10 ⁵	10 ⁶	10 ⁷	10 ⁻¹	10 ⁻²	10 ⁻³

Coding		Formula		Example	
XX		X		10K2	= 102 X 10 ² = 02C
	Res. Code		Multiplier Code		
				33R2	= 332 X 10 ⁻¹ = 51X

Resistance Code

Value	Code	Value	Code	Value	Code	Value	Code	Value	Code
100	01	162	21	261	41	422	61	681	81
102	02	165	22	267	42	432	62	698	82
105	03	169	23	274	43	442	63	715	83
107	04	174	24	280	44	453	64	732	84
110	05	178	25	287	45	464	65	750	85
113	06	182	26	294	46	475	66	768	86
115	07	187	27	301	47	487	67	787	87
118	08	191	28	309	48	499	68	806	88
121	09	196	29	316	49	511	69	825	89
124	10	200	30	324	50	523	70	845	90
127	11	205	31	332	51	536	71	866	91
130	12	210	32	340	52	549	72	887	92
133	13	215	33	348	53	562	73	909	93
137	14	221	34	357	54	576	74	931	94
140	15	226	35	365	55	590	75	953	95
143	16	232	36	374	56	604	76	976	96
147	17	237	37	383	57	619	77		
150	18	243	38	392	58	634	78		
154	19	249	39	402	59	649	79		
158	20	255	40	412	60	665	80		

Label

Label shall be marked with the following item :

- A. Nominal Resistance and Resistance Tolerance
- B. Power Rating and Size
- C. Quantity and description
- D. Part No.
- E. Lot No.
- Ex.

RT008-04		
606150040052	CHIP RESISTORS	r
Resistance: 100R Ω		$\pm 1\%$
Wattage: 0.25W	Size: 1206	
Quantity: 5000 PCS	CRG 1206 1% 100R	
PART NO. 1623403-1	RoHS 2011/65/EU	
LOT NO.	REF #	
Order Code (YYWW)	1623 Rev. BA	
		

Packing Specification:

Tape dimensions (mm)

A. Paper Taping

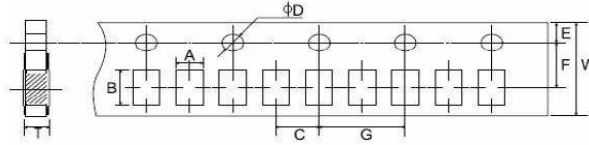

Type	A±0.2	B±0.2	C±0.05	∅D+0.1 -0	E±0.1	F±0.05	G±0.1	W±0.2	T±0.1
0201	0.40 ±0.05	0.70 ±0.05	2.0	1.5	1.75	3.5	4.0	8.0	0.42
0402	0.65	1.15	2.0	1.5	1.75	3.5	4.0	8.0	0.45

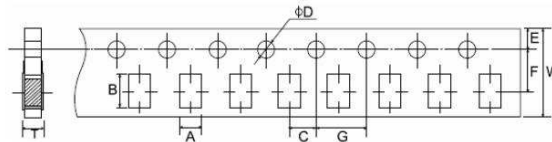

Type	A±0.2	B±0.2	C±0.05	∅D+0.1 -0	E±0.1	F±0.05	G±0.1	W±0.2	T±0.1
0603	1.10	1.90	2.0	1.5	1.75	3.5	4.0	8.0	0.67
0805	1.65	2.40	2.0	1.5	1.75	3.5	4.0	8.0	0.81
1206	2.00	3.60	2.0	1.5	1.75	3.5	4.0	8.0	0.81
1210	2.80	3.50	2.0	1.5	1.75	3.5	4.0	8.0	0.75

B. Embossed Taping

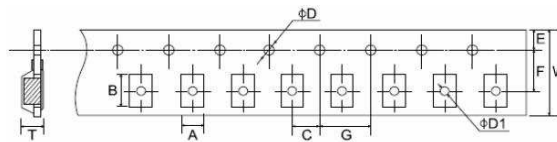

Type	A ±0.2	B ±0.2	C ±0.05	∅D+0.1 -0	∅D1+0.1 -0	E ±0.1	F ±0.05	G ±0.1	W ±0.2	T ±0.1
2010	2.90	5.60	2.0	1.5	1.5	1.75	5.5	4.0	12.0	1.0
2512	3.50	6.70	2.0	1.5	1.5	1.75	5.5	4.0	12.0	1.0

* Peeling Strength of Top Cover Tape

Test Condition: 0.1 to 0.7 N at a peel-off speed of 300 mm / min.

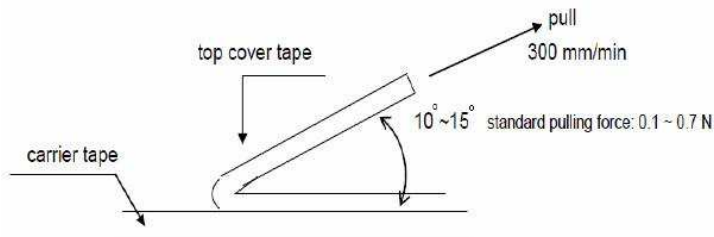

Reel Dimension (mm)

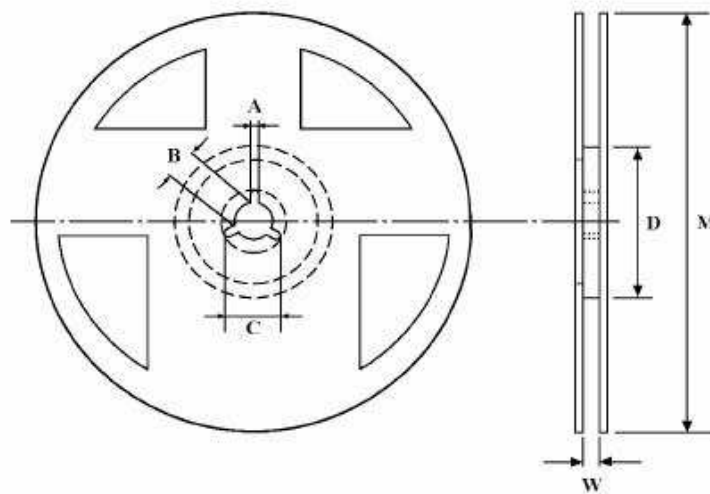

Type	Taping	Reel Quantity	A ±0.5	B ±0.5	C ±0.5	D ±1	M ±1	W ±1
0201	Paper	10,000	2	13	21	60	178	10
0402	Paper	10,000	2	13	21	60	178	10
0603	Paper	5,000	2	13	21	60	178	10
0805	Paper	5,000	2	13	21	60	178	10
1206	Paper	5,000	2	13	21	60	178	10
1210	Paper	5,000	2	13	21	60	178	10
2010	Embossed	4,000	2	13	21	60	178	13.8
2512	Embossed	4,000	2	13	21	60	178	13.8

How To Order

CRG	0603	F	10K	
Common Part	Size	Tolerance	Resistance Value	
CRG - Thick Film Chip Resistor	0201	F - ±1%	1 ohm (1Ω) 1R0	
	0402		1K ohm (1000Ω) 1K0	
	0603			
	0805			
	1206			100K ohm (100000Ω) 100K
	1210			
	2010			
	2512		1M ohm (1000000Ω) 1M0	

X-ON Electronics

Largest Supplier of Electrical and Electronic Components

Click to view similar products for [Thick Film Resistors - SMD category:](#)

Click to view products by [TE Connectivity manufacturer:](#)

Other Similar products are found below :

[CRCW04028R20JNEE](#) [CRCW06036K80FKEE](#) [CRG1206F1K58](#) [CRL0603-FW-R700ELF](#) [M55342K06B6E19RWL](#) [RC1005F1072CS](#)
[RC1005F471CS](#) [RC1005F4751CS](#) [RCP0603W100RGED](#) [RCWP72251K47FKWB](#) [RLR05C7501GPB14](#) [RLR07C5111FSBSL](#) [ERJ-](#)
[1GMF1R00C](#) [ERJ-1GMF1R20C](#) [ERJ-1GMF2R55C](#) [ERJ-1GMF8R66C](#) [25121WF1003T4E](#) [25.501.3653.0](#) [290-1.0M-RC](#) [292-1.0M-RC](#) [292-](#)
[2.2K-RC](#) [292-4.7K-RC](#) [25121WF4700T4E](#) [292-470K-RC](#) [302-1.0M-RC](#) [CPG1206F10KC](#) [CRCW02011R00FXED](#) [CRCW060315K0FKEE](#)
[CRCW060320K5FKEE](#) [CRG0201F10K](#) [RCG0402150RFKED](#) [RCG04023K92FKED](#) [RCP2512B100RGWB](#) [RCWP110010R0FKS3](#)
[RCWP11002K00FKS3](#) [RCWP12061K00FKS2](#) [3520510RJT](#) [352075KJT](#) [M55342K11B9E53RUL](#) [RMC16-102JT](#) [RMC1JPTE](#) [TR0603MR-](#)
[075K1L](#) [5-2176094-4](#) [35202K7JT](#) [WF06Q1000FTL](#) [ERJ-S03J1R0V](#) [ERJ-S14J4R7U](#) [CHP2512L4R30GNT](#) [CPCC10270R0JE32](#)
[RCWP11001K00FKS3](#)