



## Resistive Solutions For Railway Applications





## Product Portfolio for the Railway Sector

### Introduction

TE Connectivity can help you to become part of the leading force in the railway sector. For over 50-plus years, TE Connectivity has worked with industry leaders to lower costs and develop systems to increase reliability, and to devise new and innovative ways to implement technically advanced products for the railway market. Find more information at [te.com/railway](http://te.com/railway)

Power electronics design in railway applications presents unique environmental, mechanical and electrical challenges in the selection of power resistor components and assemblies. The selection of resistors must be engineered to take these factors into account. **Why?**

- Resistors must be carefully chosen to meet the specific performance requirements including factors like power rating, power density, accuracy, stability, short-term overload capacity, capacitance and inductance and thermal de-rating.
- In addition, heat dissipation, electrical isolation and other requirements often call for specialized packaging solutions.

#### Working with TE Connectivity

- We provide you with reliable technology for high safety railway applications.
- As a global company, we operate wherever you do and we can support you worldwide through a single account management program, which simplifies design and sourcing for you.
- Through our global manufacturing network in 25 countries, we can balance e.g. exchange rate volatility to offer you competitive pricing for your local market needs.
- Depending on your application, you can either choose a field-proven component from our standard resistor portfolio.
- Or, if you need a custom solution, our experienced field engineering and design team works closely with your engineering personnel to meet your exact requirements.
- We conduct in-house testing in our own R&D laboratory.

#### TE Connectivity's Passives Core Product Offering for Railway include:

##### Power Resistors

- Power ratings from 0.25W to > 300kW
  - Range of applications
    - Balancing
    - Capacitor Pre-charge / discharge
    - Chopper
    - Crowbar
    - Current sense
    - Filter
    - Inrush limiting
    - Snubber
  - Range of technologies
    - Carbon composition
    - Ceramic composition
    - Foil
    - Thick film
    - Thin film
    - Wire-wound
  - In-house design and test facilities for development of specification driven products
  - Customisation capabilities of standard products
  - Supported by wide range of commodity power resistors
- We design tests in conjunction with your specifications to include cyclic rated power and overload testing, adiabatic (single shot and frequency) testing, environmental, mechanical and repetitive pulse testing. Qualification testing is carried out to a proven procedure and the product development stages are well documented and approved by a design approval team.
  - We offer 3D modeling of the product so you have an understanding of what the product will look like from the start of the project.
  - TE supplies quick turnaround samples.



## Product Portfolio for the Railway Sector

### Product / Application Guide

Family	Technology	Key Features	Pre-Charge / Discharge	Inrush Limiting	Crowbar	Balancing	Current Sense	Snubber	Chopper	Filter	Page No.
BDF	Foil	400W Isotop									17
BDS	Thick Film	100W - 600W Isotop									17
C	Wire-wound	3 - 4W Vitreous	•	•		•	•				23
CBT/CCR	Carbon/Ceramic	1/4 - 2W Pulse Withstand		•							34
CFH	Wire-wound	350 - 2200W Aluminium Housed		•	•						10
CJS	Wire-wound	175 - 1000W Mineral Filled			•						7
CJT	Wire-wound	60 - 2000W Aluminium Housed	•		•				•	•	8
ER/ES	Wire-wound	0.5 - 14W Silicone	•	•		•	•				25
HB	Thick Film	High Voltage Planar				•		•			29
HH/HJ	Thick Film	High Voltage				•					30
HS	Wire-wound	5 - 300W Aluminium Housed	•	•	•					•	12
HVR	Thick Film	Up to 50kV High Voltage Tubular				•					28
Load Bank	Wire-wound	Customised Load Bank			•				•		6
MPC	Thick Film	3 - 10W Planar		•		•		•			20
MPR	Thin Film	20W T0220 Radial				•		•			19
MPT	Thick Film	20 - 100W Radial		•		•		•			18
R5000	Wire-wound/Foil	250W Low Profile					•	•			11
RGP	Thick Film	0.25W High Ohmic				•		•			31
RR	Metal Film	1, 2 & 3W Power	•			•		•			32
ROX	Metal Oxide	0.5 - 5W Oxide Power	•			•		•			33
SBC	Wire-wound	4 - 40W Ceramic Cased	•	•						•	24
SBL	Foil	4 - 5W Low Ohmic					•				26
SQ	Wire-wound/Oxide	2 - 40W Ceramic Cased	•	•			•			•	21-22
TE	Wire-wound	50 - 2500W Tubular	•	•	•				•	•	15
THS	Wire-wound	5 - 50W Aluminium Housed	•	•	•					•	14
TT	Wire-wound	10 - 1000W Tubular	•	•	•				•	•	16
YP	Wire-wound	8 - 10W Capacitor Discharge	•								27



Foil Technology



Wire-wound Technology



Thick Film Technology

## Application Guide

Below is a typical frequency convertor schematic used in railway applications.

The diagram shows all the different applications where resistive components are required.

Page 3 provides a cross reference of TE Connectivity's resistive solutions for each application shown.

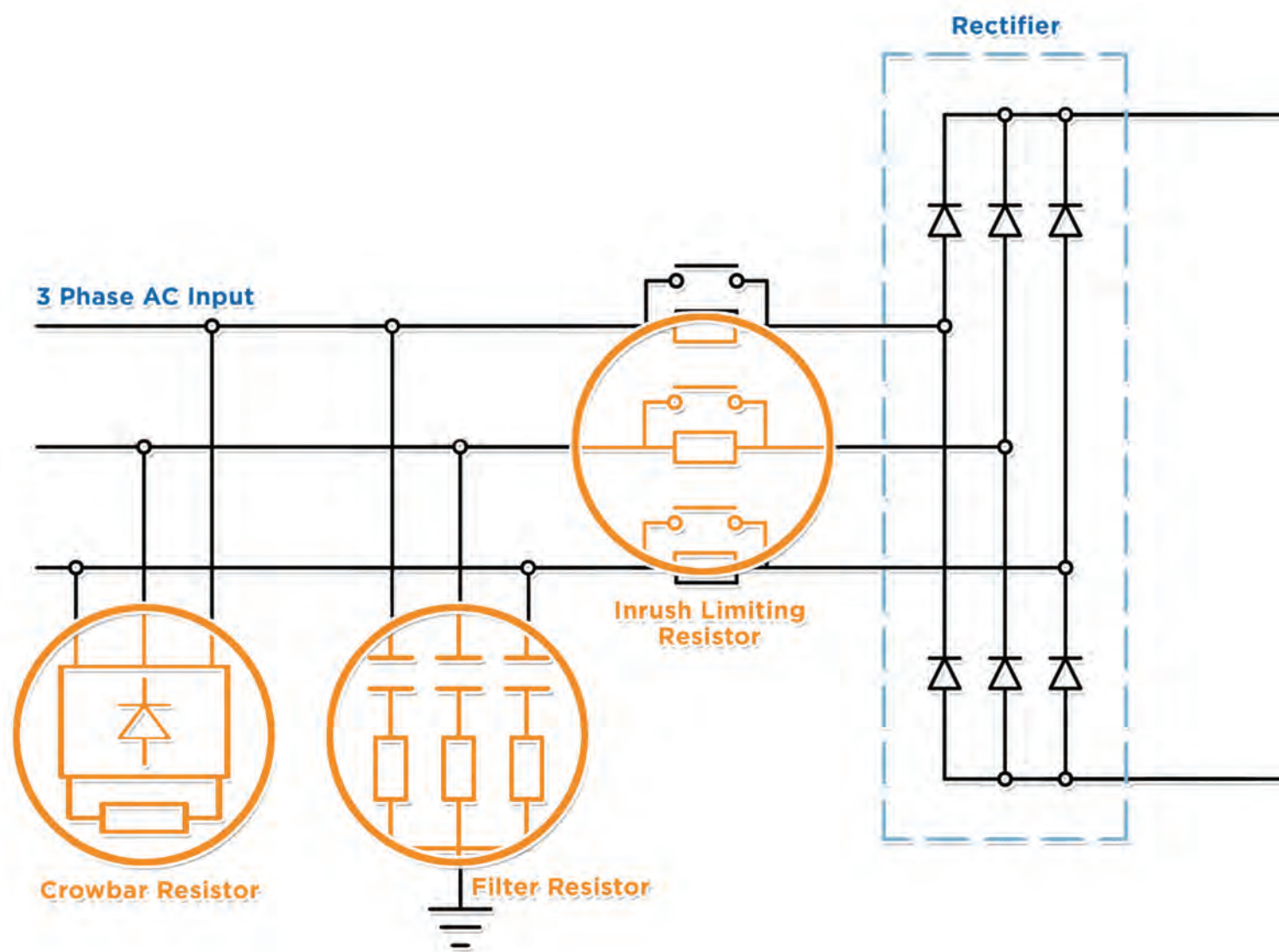

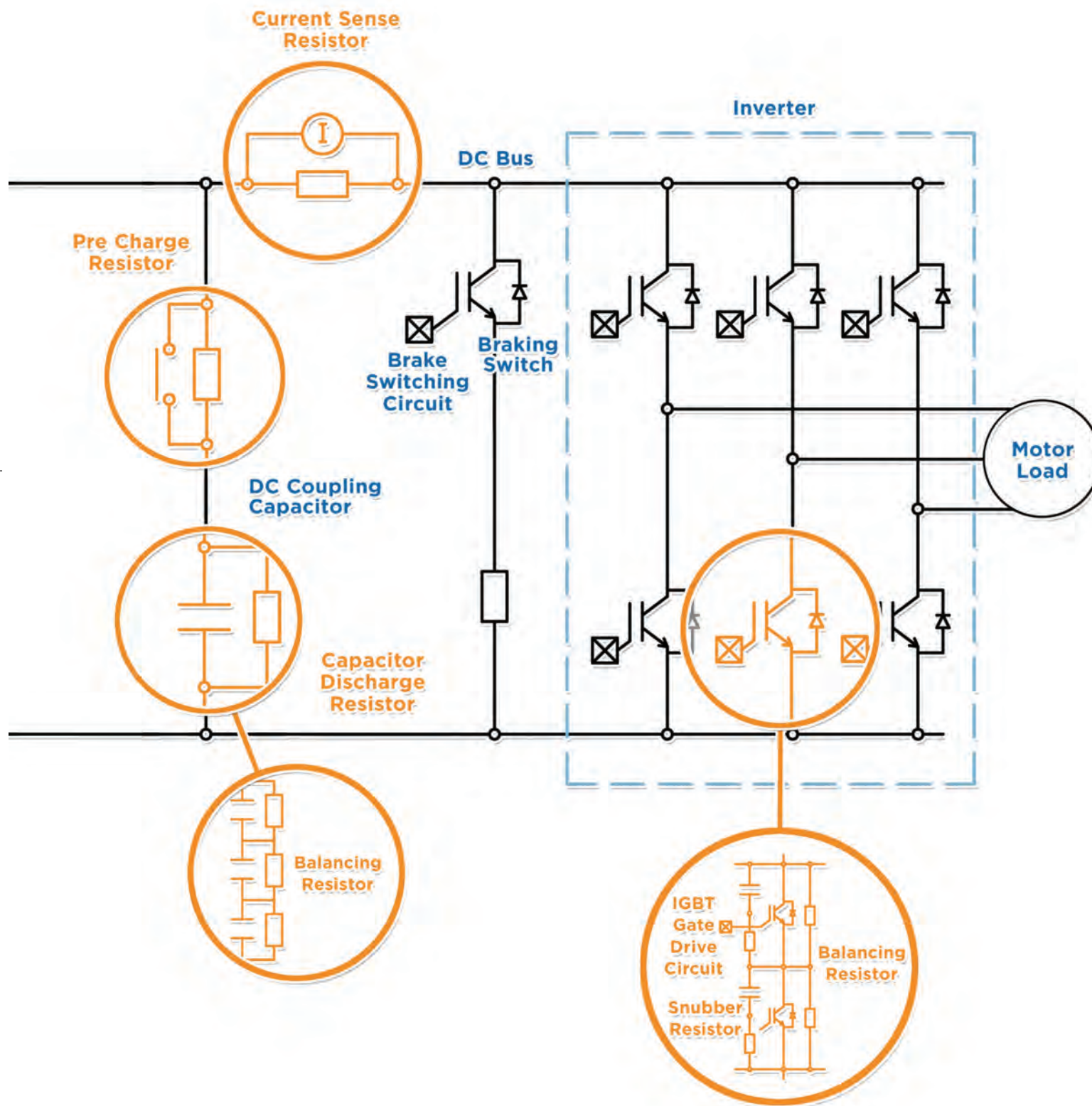



## Product Portfolio for the Railway Sector

### Type Load Bank Series

Offered in a wide range of package styles, including IP sealing and in a variety of resistive configurations, TE Connectivity's resistor banks are the result of over 40 years attention to power dissipation, pulse energy absorption and resistive technology developments. High power resistor banks are used in a wide variety of applications, such as testing of engine generator sets, periodic exercising of stand-by engine generator sets, battery system testing, ground power testing, load optimization in prime power applications, factory testing of turbines etc

#### Key Features

- 0.5 - 300kW power dissipation
- 0.5 - 10kV rated voltage
- Up to 30kV dielectric strength
- Up to 250A rated current
- IP20 - IP23 environmental protection
- Custom design solutions
- Modular design

#### Applications

- Crowbar
- Load test simulation



### Characteristics - Electrical

#### Case Mounted - LBR



Power Range:	0.5kW - 10kW
Operating Voltage Range:	0.5kV - 3kV
Resistance Range:	1R0 - 1K0
Voltage Withstand:	2.5kV - 5kV/1min 50Hz
IP Class:	IP20
Vibration:	0.5g
Rated Temperature Rise:	375°C
Temperature Drift:	80 - 1260ppm/°C

#### Open Frame - TEBR



Power Range:	1kW - 500kW
Operating Voltage Range:	0.5kV - 3kV
Resistance Range:	1R0 - 1K0
Voltage Withstand:	2.5kV - 5kV/1min 50Hz
IP Class:	IP20
Vibration:	0.5g
Rated Temperature Rise:	375°C
Temperature Drift:	80 - 1260ppm/°C

#### Cabinet Mounted - LBR



Power Range:	11kW - 300kW
Power Factor Range:	0.1 - 1 adjustable
Operating Voltage Range:	0.5kV - 10kV
Resistance Range:	R50 - 100R
Dielectric Strength:	2.5kV - 30kV/1min 50Hz
IP Protection:	IP20 - IP23
Vibration:	0.5g
Temperature Rise:	375°C
Air Flow:	7000m³/h
Temperature Coefficient:	80 - 1260ppm/°C



## Product Portfolio for the Railway Sector

### Type CJS Series

The CJS is a mineral filled, aluminium housed resistor designed for high power loads. The case can be internally earthed for extra safety.

#### Key Features

- Fully insulated and sealed
- Low inductance possible
- FASTON or wire leads
- Custom designs welcome
- UL approved

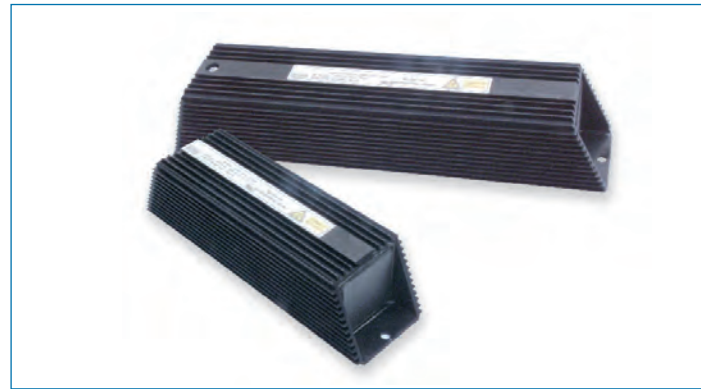

#### Characteristics - Electrical

	CJS 275	CJS 300	CJS 550	CJS 600	CJS 700	CJS 1000
Power on Heatsink (W):	275	300	550	600	700	1000
Power Free Air (W):	175	225	325	450	525	525
Resistance Range:	5R0-7K5	10R-13K	20R-26K	20R-32K	20R-32K	20R-36K
Standard Resistance Tolerance:	±5% (others by request)					
Long Term Stability:	< 5% over 1000 hours - 1.5 hours on 0.5 hours off					
Temperature Coefficient:	±150ppm/°C					
Insulation Voltage:	5.0kV or AC peak					
Insulation Resistance:	100MΩ at 250V					
Element Voltage:	3 kV AC, RMS max (do not exceed when applying pulse overload)					
Short Time Overload:	100 x 1 second, 20 x 5 seconds, 10 x 10 seconds (not 275 and 1000)					

#### Pulse Energy Versus Resistance

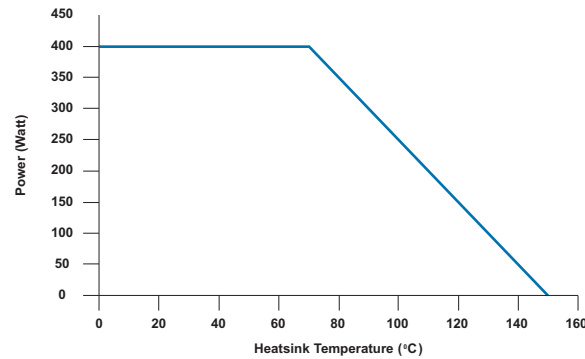
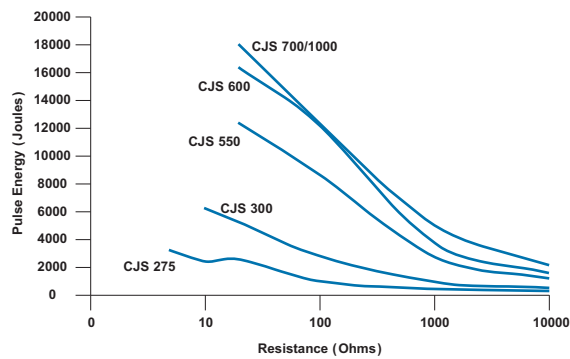

#### Dimensions

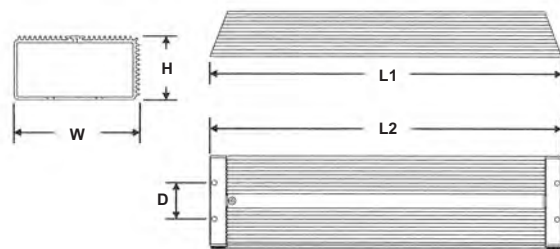

	L1	L2	H	W	D
CJS 275	200	190	55	58	-
CJS 300	280	270	55	58	-
CJS 550	280	270	55	84	40
CJS 600	340	330	54	84	40
CJS 700	400	390	52	103	40
CJS 1000	400	385	103	52	30



## Product Portfolio for the Railway Sector

### Type CJT Series

TE Connectivity supplies standard and custom-designed power resistors for industrial, control and general-purpose applications. The CJT Series of resistors are advantageous to conventional ceramic resistors in the terms of weatherproofing, oscillation-resistance and safety. They are widely applied to a range of electrical circuits including power supplies, inverters and servo systems. With easy airtight fitting and the ability to fit a heatsink the resistor is highly suited to challenging environmental conditions.

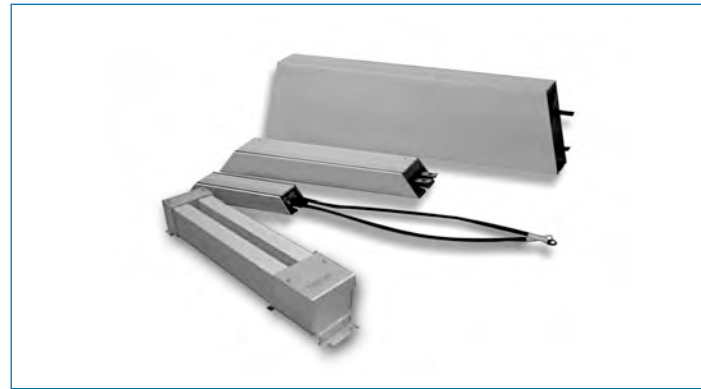

#### Key Features

- Up to 2000W power rating
- Aluminium enclosure
- Vibration resistant
- Modular versions available
- Environmental protection to IP54

#### Applications

- Power supplies
- Inverters
- Servo systems
- Electrical systems in difficult environments

#### Characteristics - Electrical

Type:	CJT60	CJT80	CJT100	CJT120	CJT150	CJT200	CJT300	CJT400	CJT500	CJT800	CJT1000	CJT1200	CJT1500	CJT2000
Rated Power in Free Air (W):	60	80	100	120	150	200	300	400	500	800	1000	1200	1500	2000
Ohmic Value - min/max:	1R0 to 2K7 (standard tolerance 5%)													
Temp. Coefficient of Resistance:	440ppm													
Resistor Element max. Working Voltage:	1kV													
Dielectric Voltage:	AC2.5KV / 1min 50Hz													
Insulation Resistance (MΩ):	R≥100MΩ													
Max. Surface Temp at Rated Power Free Air (°C):	206°C	221°C	254°C	267°C	286°C	306°C	334°C	370°C	358°C	311°C	372°C	406°C	419°C	453°C
Weight:	150g	185g	240g	280g	300g	445g	600g	765g	965g	1.18kg	3.46kg	3.885kg	4.31kg	4.89kg
Terminal Creep Distance:	N/A									30mm	42mm	42mm	42mm	42mm

#### Temperature Rise

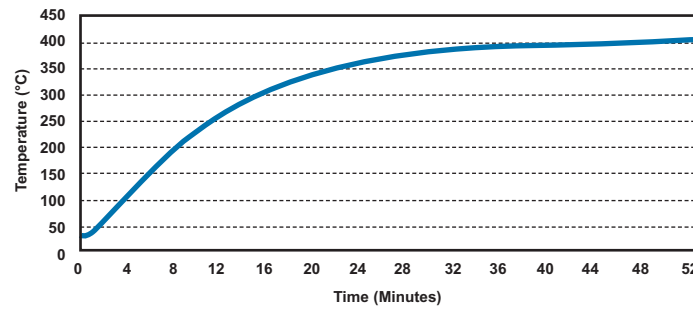

#### Derating Curve

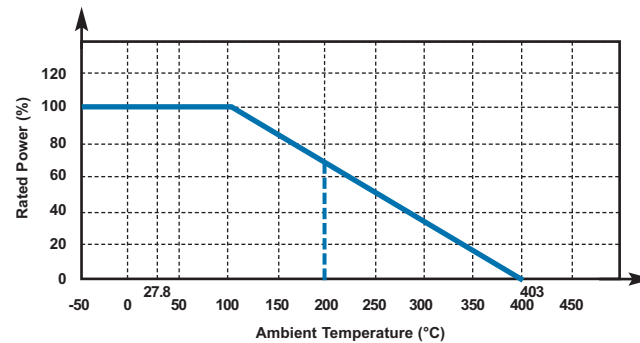





## Product Portfolio for the Railway Sector

### Type CJT Series

#### Dimensions - CJT

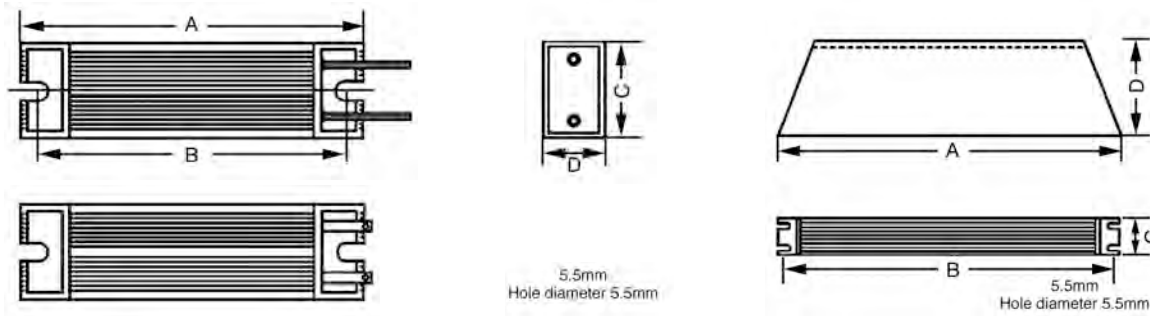

Rated Power (Watt)	Dimensions			
	A	B	C	D
60	115	98	40	20
80	140	123	40	20
100	165	148	40	20
120	190	173	40	20
150	215	197	40	20
200	165	147	60	30
300	215	197	60	30

Rated Power (Watt)	Dimensions			
	A	B	C	D
400	265	247	60	30
500	335	317	60	30
800	400	382	61	59
1000	400	384	50	107
1200	450	434	50	107
1500	485	470	50	107
2000	550	532	50	107

#### Dimensions - CJTM

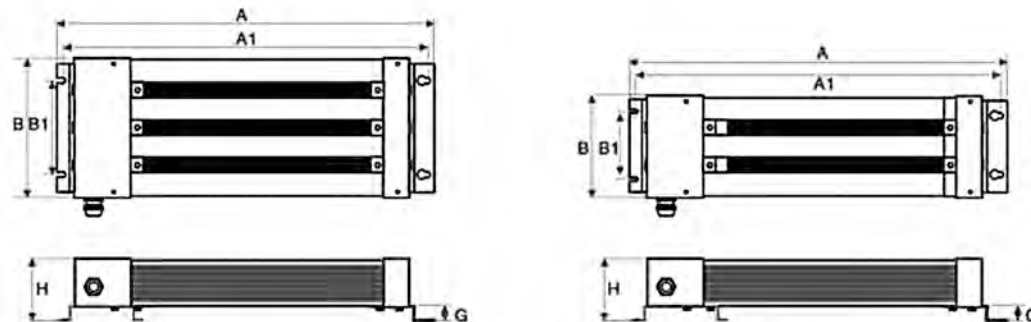

Type	Rated Power (Watt)	Resistance (Ω)		Dimensions (mm)						Connecting Wire (mm <sup>2</sup> )	Lead Length (mm)
		Min	Max	A	A1	B	B1	G	H		
CJTM1U	200	1	2K7	268	253	64	30	20	54	2.5	500
CJTM1U	300	1	2K7	318	303	64	30	20	54	2.5	500
CJTM1U	400	1	2K7	368	353	64	30	20	54	2.5	500
CJTM1U	500	1	2K7	438	423	64	30	20	54	2.5	500
CJTM1U	600	1	2K7	503	488	64	30	20	54	2.5	500
CJTM2U	800	2	5K4	372	355	84	49	20	84	2.5	500
CJTM2U	1000	2	5K4	442	425	84	49	20	84	2.5	500
CJTM2U	1200	2	5K4	507	490	84	49	20	84	2.5	500
CJTM3U	1200	3	8K1	372	355	134	75	20	84	2.5	500
CJTM3U	1500	3	8K1	442	425	134	75	20	84	2.5	500
CJTM3U	1800	3	8K1	507	490	134	75	20	84	2.5	500
CJTM4U	1600	4	10K8	372	355	184	125	20	84	2.5	500
CJTM4U	2000	4	10K8	442	425	184	125	20	84	4	500
CJTM4U	2400	4	10K8	507	490	184	125	20	84	4	500
CJTM5U	2000	5	13K5	372	355	234	175	20	84	4	500
CJTM5U	2500	5	13K5	442	425	234	175	20	84	4	500
CJTM5U	3000	5	13K5	507	490	234	175	20	84	4	500



## Product Portfolio for the Railway Sector

### Type CFH Series

The CFH is a high quality range of aluminium housed power resistors offering environmental protection to IP55, 6kV dielectric strength, 1.8kW power dissipation, and the ability to absorb electrical pulses of up to 24kJ. The use of advanced materials in the construction of this device enables operating temperatures of up to 450°C giving very high power density.



#### Key Features

- 2200W in a 72cm<sup>2</sup> footprint
- Impressive pulse capability
- No heatsink required
- Slimline casing
- Environmental protection to IP55

#### Applications

- Balancing
- Capacitor charging & discharging
- Crowbar
- Filter
- Inrush limiting

#### Characteristics - Electrical

	CFH350	CFH500	CFH750	CFH1100
Dissipation @ 25°C with Heatsink (Watts):	650	850	1300	1800
Without Heatsink:	350	500	750	1100
With Water Cooled Heatsink (40°C):	750	1000	1500	2200
Overload Rating (5s):	4000	5600	8000	12000
Ohmic Value (Ohms):	R50 to 10K	R50 to 18K	R50 to 27K	R50 to 27K
Tolerance:	±5% Standard			
Maximum Working Voltage (DC/ACrms) Volts:	1500	2500	3500	4000
Insulation Resistance (Volts):	≥10000MΩ			
Dielectric Strength (AC peak) Volts:	4500 standard and 6000 special			
Inductance (Henries):	5-50μH at 1000Hz	7-70μH at 1000Hz	10-100μH at 1000Hz	20-200μH at 1000Hz
Standard Heatsink Area (mm <sup>2</sup> ):	1600	1600	1600	1600
Thickness (mm):	135	135	135	135
Protection Grade (IP):	IP55			
Heat Dissipation:	Although the use of proprietary heat sinks with lower thermal resistance is acceptable, up rating is not recommended. The use of proprietary heat sink compound to improve thermal conductivity is essential.			

#### Derating Curve

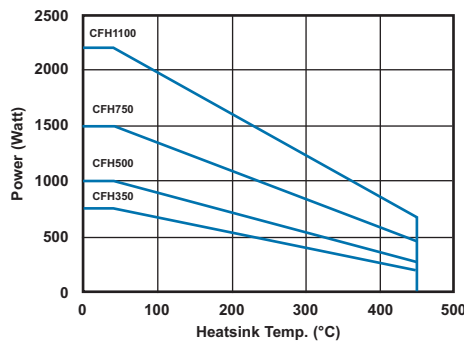

#### Surface Temperature Rise

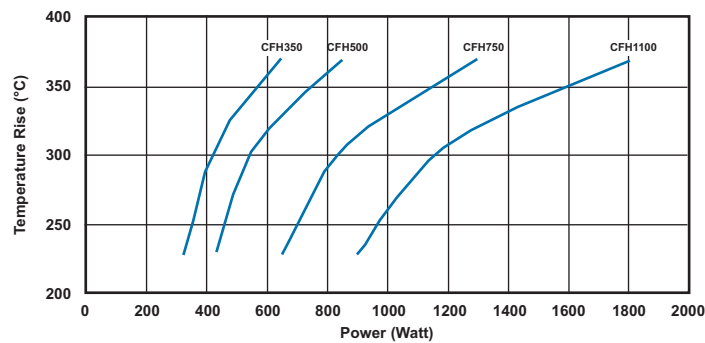

#### Dimensions

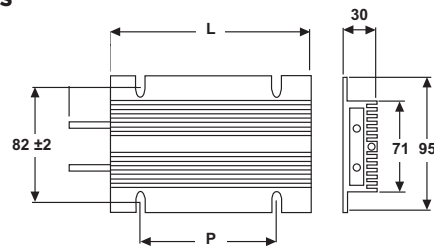

Type	CFH350	CFH500	CFH750	CFH1100
L	110mm	160mm	220mm	320mm
P	60mm	110mm	140mm	240mm



## Product Portfolio for the Railway Sector

### Type R5000 Series

The R5000 by TE Connectivity is a high specification flat resistor module with flying leads, designed for snubbing applications where size and weight are at a premium. With a height of 13mm, an overall weight of 150g, and a rated power of 250W, this resistor offers unbeatable performance in terms of power density. Advanced construction methods and high performance materials give a rugged and resilient device capable of high pulse energy absorption, low inductance, high stability, and a low TCR. This device can be fused to offer circuit protection and is available in a wide range of resistance values.



#### Key Features

- 250W in a 77cm<sup>2</sup> footprint
- Special fuse option available
- Low inductance for the fastest switching speeds
- High quality aluminium construction - just 150g
- UL approved

#### Applications

- Snubbing
- Filter
- Power supplies
- Electrical machinery

#### Characteristics - Electrical

Dissipation @ 20°C with Heatsink (Watts):	250
Ohmic Value - Foil / Wire-wound (Ohms):	R05 - 20R / 10R - 10K (± 10% Tolerance)
Limiting Element Voltage (DC/ACrms) Volts:	500V DC or AC Peak
Dielectric Strength (AC peak) Volts:	500V (Can be uprated)
Inductance - Foil Element (Henries):	<1 µH
Capacitance (F):	440pF
TCR (ppm/°C):	20ppm/°C - 150ppm/°C (to design)
Stability (1000h/250W):	ΔR < 5%
Terminal Strength:	5kg pull strength
Temperature Range:	-50°C to 125°C
Humidity (Silicon-sealed Option):	96% RH @ 40°C - 56days. ΔR <1%
Orientation:	Vertical
Number of Mounting Holes:	2
Cable Length:	130mm ± 10mm
Heat Dissipation:	Although the use of proprietary heat sinks with lower thermal resistance is acceptable, up rating is not recommended. The use of proprietary heat sink compound to improve thermal conductivity is essential.

#### Derating Curve

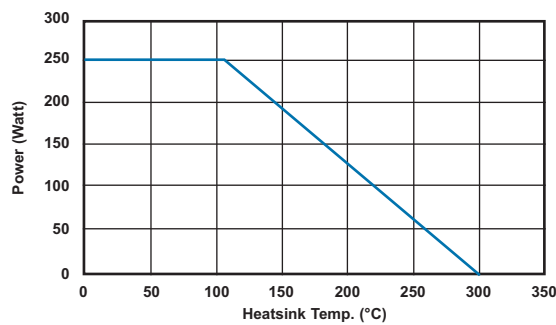

#### Pulse Energy (Foil Element)

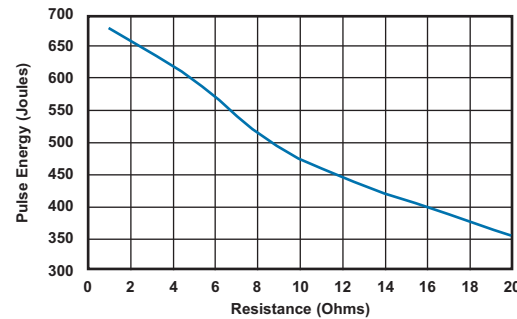

#### Dimensions

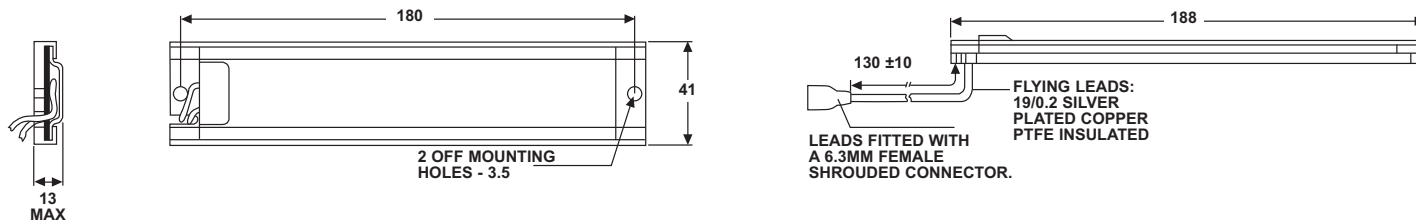

Literature No. 4-1773460-6  
Issued 3-11

Dimensions are in millimeters and inches unless otherwise specified. Values in brackets are standard equivalents.

Dimensions are shown for reference purposes only. Specifications subject to change.

TE Connectivity / Berwyn, PA  
For email, phone or live chat, go to: [te.com/help](http://te.com/help)



## Product Portfolio for the Railway Sector

### Type HS Series

TE Connectivity supplies standard and custom designed aluminium housed resistors for general-purpose use, power supplies, power generation and the traction industry. The HS is a range of extremely stable, high quality wire-wound resistors capable of dissipating high power in a limited space with relatively low surface temperature. The power is rapidly dissipated as heat through the aluminium housing to a specified heatsink. The resistors are made from quality materials for optimum reliability and stability. TE Connectivity can test resistors to conform to relevant international, MIL or customer specifications. TE Connectivity is happy to advise on the use of resistors for pulse applications and to supply information for high voltage use and low-ohmic value, alternative mountings and termination type.



#### Key Features

- Established product with proven reliability
- 5 - 300W
- Versatile product
- Custom designs
- Low resistance, low inductance and higher voltage versions available

#### Applications

- Balancing resistor
- Filter
- Crowbar
- Capacitor charging & discharging

#### Characteristics - Electrical

	HSA5	HSA10	HSA25	HSA50	HSC75	HSC100	HSC150	HSC200	HSC250	HSC300
Dissipation @ 25°C with/without Heatsink (Watts):	10/5.5	16/8	25/12.5	50/20	75/45	100/50	150/55	200/50	250/60	300/75
Ohmic Value min/max (Ohms):	R01/10K	R01/15K	R01/36K	R01/100K	R05/50K	R05/100K	R10/100K	R10/50K	R10/68K	R10/82K
Max. Working Voltage (DC or ACrms) Volts:	160	265	550	1250	1400	1900	2500	1900	2200	2500
Dielectric Strength (AC peak) Volts:	1400	1400	2500	2500	5000	5000	5000	5600	5600	5600
Stability (% resistance change, 1000 hours) (%):	1	1	1	1	2	2	2	3	3	3
Standard Heatsink Area (mm <sup>2</sup> ):	41500	41500	53500	53500	99500	99500	99500	375000	476500	578000
Thickness (mm):	1	1	1	1	3	3	3	3	3	3
Number of Mounting Holes:	2 hole	2 hole	2 hole	2 hole	4 hole	4 hole	4 hole	6 hole	6 hole	6 hole

#### Pulse Energy HSA5 to HSC75

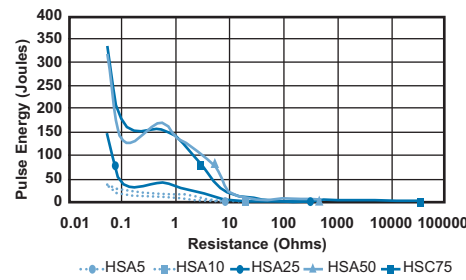

#### Pulse Energy HSC100 to HSC300

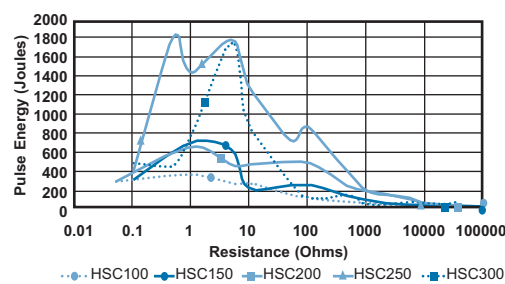



## Product Portfolio for the Railway Sector

### Type HS Series

#### Surface Temperature Rise

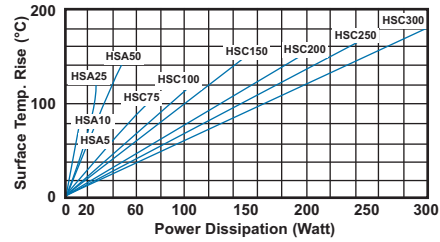

For resistor mounted on standard heatsink, related to power dissipation

#### Dimensions - HSA5 - HSA50

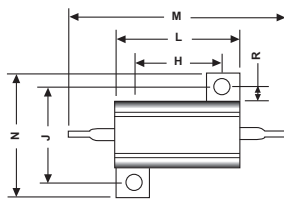

#### HSC75 - HSC150

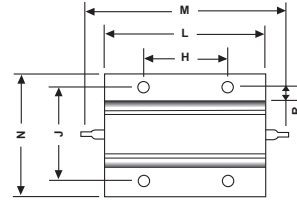

#### HSC200+

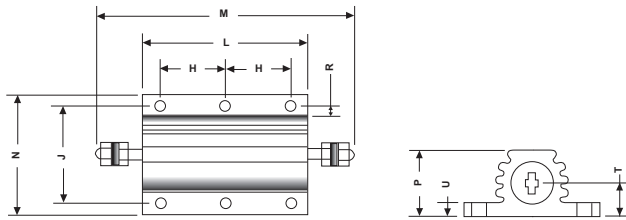

Type	H±0.3	J±0.3	K±0.2	L Max	M Max	N Max	P Max	R Min	T±0.5	U Max
HSA5	11.3	12.4	2.4	17.0	30.0	17.0	9.0	1.9	3.4	2.5
HSA10	14.3	15.9	2.4	21.0	36.5	21.0	11.0	1.9	5.2	3.2
HSA25	18.3	19.8	3.3	29.0	51.8	28.0	15.0	2.8	7.2	3.2
HSA50	39.7	21.4	3.3	51.0	72.5	30.0	17.0	2.8	7.9	3.2
HSC75	29.0	37.0	4.4	49.0	71.0	47.5	26.0	5.0	11.5	3.5
HSC100	35.0	37.0	4.4	65.5	87.5	47.5	26.0	5.0	11.5	3.5
HSC150	58.0	37.0	4.4	98.0	122.0	47.5	26.0	5.0	11.5	3.5
HSC200	35.0	57.2	5.3	90.0	143.0	73.0	45.0	5.6	22.2	6.75
HSC250	44.5	57.2	5.3	109.0	163.0	73.0	45.0	5.6	22.2	6.75
HSC300	52.0	59.0	6.5	128.0	180.0	73.0	45.0	6.0	22.2	6.75

#### HSA5 - HSA50

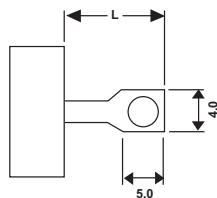

#### HSC200-HSC300

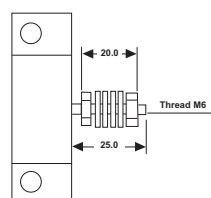

Type	L
HSA5, 10	7
HSA25, 50	10
HSC75, 100, 150	8



## Product Portfolio for the Railway Sector

### Type THS Series

The THS is a range of extremely stable, high quality wire-wound resistors capable of dissipating high power in a limited space with relatively low surface temperature. The power is rapidly dissipated as heat through the aluminium housing to a specified heatsink. The resistors are made from quality materials for optimum reliability and stability. TE Connectivity can test resistors to conform to relevant international, MIL or customer specifications.

#### Key Features

- Established product with proven reliability
- 10 - 75W
- Versatile product

#### Applications

- Balancing resistor
- Filter
- Crowbar
- Capacitor charging & discharging



#### Characteristics - Electrical

	THS10	THS15	THS25	THS50	THS75
Dissipation @ 25°C with / without Heatsink (Watts):	10 / 5.5	15 / 8	25 / 12.5	50 / 20	75 / 40
Ohmic Value min/max (Ohms):	R01-10K	R01-15K	R01-36K	R01-50K	R05-50K
Max. Working Voltage (DC or ACrms) Volts:	160	265	550	1250	1400
Dielectric Strength (AC Peak) Volts:	1400	1400	2500	2500	5000
Stability (% resistance change, 1000 hours) (%):	1	1	1	1	2
Standard Heatsink Area-mm <sup>2</sup> / Thickness mm:	41500 / 1	41500 / 1	53500 / 1	53500 / 1	99500 / 3
Number of Mounting Holes:	2 hole	2 hole	2 hole	2 hole	4 hole

#### Derating Curve

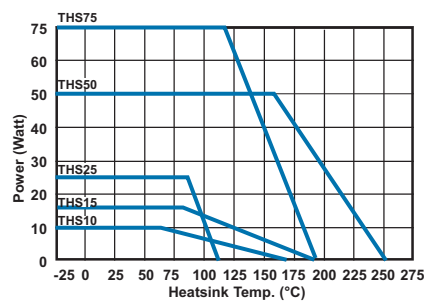

#### Pulse Energy THS10 to THS75

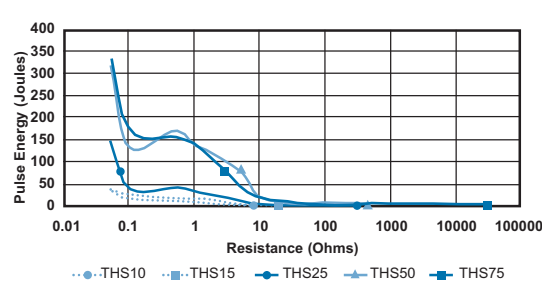

#### Surface Temperature Rise

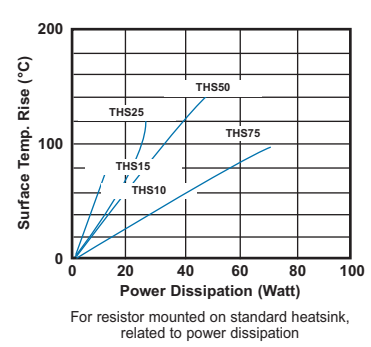

#### Dimensions - THS10 - THS50

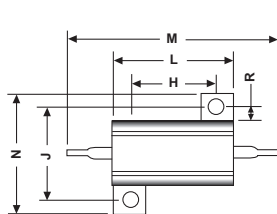

#### THS75

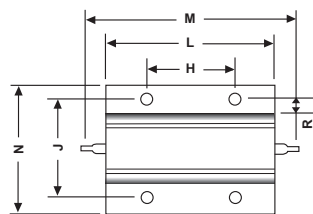

Type	H±0.3	J±0.3	L Max	M Max	N Max	P Max	R Min	T±0.5	U Max
THS10	11.3	12.4	17.0	30.0	17.0	9.0	1.9	3.4	2.5
THS15	14.3	15.9	21.0	36.5	21.0	11.0	1.9	5.2	3.2
THS25	18.3	19.8	29.0	51.8	28.0	15.0	2.8	7.2	3.2
THS50	39.7	21.4	51.0	72.5	30.0	17.0	2.8	7.9	3.2
THS75	29.0	37.0	49.0	71.0	47.5	26.0	5.0	11.5	3.5

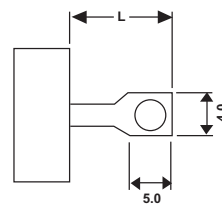
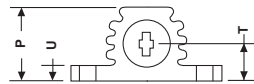

Type	L
THS10, 15	7
THS25, 50	10
THS75	8



## Product Portfolio for the Railway Sector

### Type TE Series

The TE Connectivity range of mullite coated tubular ceramic core resistors have a corrugated ribbon element for rapid cooling effect to enable up to 2500W power handling capability. Designed for heavy duty machinery, electrical equipment, motor control etc. requiring stability and reliability.

#### Key Features

- Mullite coated
- Up to 2500W power rating
- Corrugated ribbon element for rapid cooling
- 3x overload for 5 seconds
- Custom terminations/ leads available
- Flameproof construction

#### Applications

- Capacitor charging & discharging
- Load test simulation
- Motor start/stop cycles
- Equipment discharge

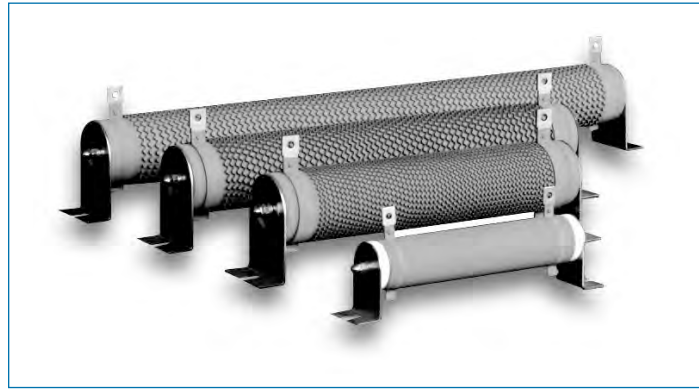

#### Characteristics - Electrical

Temperature Coefficient of Resistance:	Within $\pm 440\text{ppm}/^\circ\text{C}$
Rated Power Free Air:	50 - 2500W
Operating Temperature Range :	$-25^\circ\text{C}$ to $+225^\circ\text{C}$
Resistance Range (Ohms):	See resistance range chart below
Selection Series:	E12
Tolerance:	$\pm 5\%$ , $\pm 10\%$ as per resistance range chart below

Type	Resistance Value	Tolerance
50W	R10 – R99	10%
	1R0 – 2K7	5%
60W	R10 – R99	10%
	1R0 – 2K7	5%
80W	R10 – R99	10%
	1R0 – 2K7	5%
100W	1R0 – 2K7	5%
120W	1R0 – 2K7	5%
150W	1R0 – 2K7	5%
200W	1R0 – 2K7	5%

Type	Resistance Value	Tolerance
300W	1R0 – 2K7	5%
400W	1R0 – 2K7	5%
500W	1R0 – 2K7	5%
600W	1R0 – 2K7	5%
750W	1R0 – 2K7	5%
1000W	1R0 – 2K7	5%
1200W	1R0 – 2K7	5%
1500W	1R0 – 2K7	5%
2000W	1R0 – 2K7	5%
2500W	1R0 – 2K7	5%

#### Derating Curve

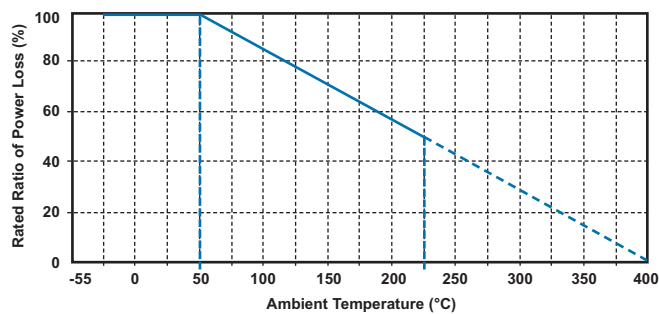

#### TE Temperature Rise

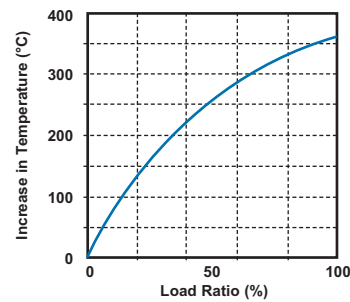

#### Dimensions

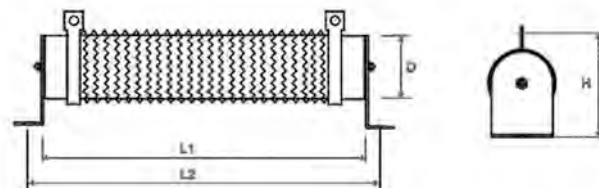

Rated Power	Dimensions			
	L1±2	L2±5	D±2	H1±3
50	102	124	28	61
60	102	124	28	61
80	152	174	28	61
100	182	204	28	61
120	182	204	28	61
150	195	217	40	81
200	195	217	40	81
300	282	304	40	81
400	282	304	40	81

Rated Power	Dimensions			
	L1±2	L2±5	D±2	H1±3
500	316	338	50	101
600	345	367	40	81
750	316	338	50	101
1000	300	325	60	119
1200	415	440	60	119
1500	415	440	60	119
2000	510	535	60	119
2500	600	625	60	119

Literature No. 4-1773460-6  
Issued 3-11

Dimensions are in millimeters and inches unless otherwise specified. Values in brackets are standard equivalents.

Dimensions are shown for reference purposes only. Specifications subject to change.

TE Connectivity / Berwyn, PA  
For email, phone or live chat, go to: [te.com/help](http://te.com/help)



## Product Portfolio for the Railway Sector

### Type TT Series

These high power tubular resistors have a high resistance to heat, and a small resistance to temperature co-efficient. Relatively small in size, their ability to take a large load make them ideal for use in heavy electrical machinery. Available as standard wire-wound resistor coated with flameproof enamel paint or ribbon style also coated with flameproof enamel paint.

#### Key Features

- High resistance to heat
- Small resistance temperature coefficient
- Small in size
- Adjustable version available
- Ribbon version available

#### Applications

- Crowbar
- Inrush limiting
- Balancing
- Filter
- Electrical machinery
- Capacitor charging & discharging



#### Characteristics - Electrical

Resistance Values:	R20 to 70K
Resistance Tolerance:	5%, 10%
Temp. Coefficient of Resistance:	within $\pm 400\text{ppm}/^\circ\text{C}$
Rated Power @ 70°C:	10 - 1000W nominal
Operating Temperature Range:	-55°C to +200°C

#### Derating Curve

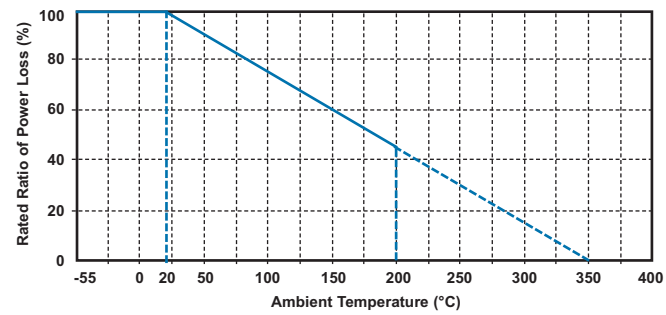

#### Dimensions - TTR Series

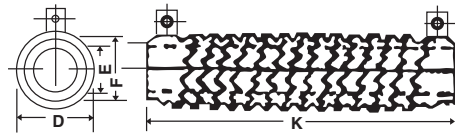

Power Rating	Dimensions (mm)				Resistance Range (Ohms)
	D $\pm 1.0$	E $\pm 2.0$	F $\pm 1.0$	K $\pm 2.0$	
90W	33	15	26	90	R2 - 7R5
120W	33	15	26	115	R2 - 10R
150W	33	15	26	140	R3 - 12R
180W	33	15	26	165	R3 - 15R
225W	33	15	26	195	R43 - 18R
300W	33	15	26	254	R51 - 20R
450W	48	25	42	254	R82 - 25R
600W	48	25	42	330	1R - 30R
1000W	48	25	42	420	2R - 33R

#### TTH Series

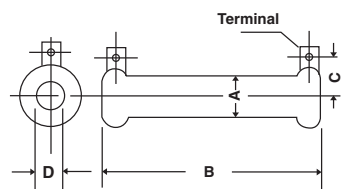

Power Rating	Dimensions (mm)				Resistance Range (Ohms)	
	A $\pm 1.0$	B $\pm 2.0$	C $\pm 3.0$	D $\pm 2.0$	TTH	TTHA
10W	12	45	16	5	1R - 1K	1R - 470R
15W	15	45	17	7	1R - 2K	1R - 1K
20W	19	50	19	9	1R - 3K	1R - 1K5
25W	19	60	19	9	2R - 3K9	2R - 2K
30W	19	75	19	9	2R - 4K3	2R - 2K2
40W	19	90	19	9	2R - 5K6	2R - 3K
50W	26	75	31	15	3R - 7K5	3R - 3K6
60W	28	90	31	15	3R - 10K	3R - 4K7
80W	28	115	31	15	3R - 12K	3R - 5K6
100W	28	140	31	15	4R3 - 15K	4R3 - 7K5
120W	28	165	31	15	4R3 - 20K	4R3 - 10K
150W	28	195	31	15	5R1 - 22K	5R1 - 11K
200W	28	254	31	15	5R1 - 30K	5R1 - 15K
300W	42	254	48	25	5R1 - 39K	5R1 - 20K
400W	42	330	48	25	10R - 47K	10R - 24K
600W	42	420	48	25	10R - 68K	10R - 33K

#### TTHA Series

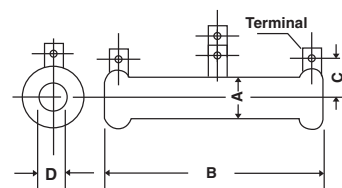





## Product Portfolio for the Railway Sector

### Type BDS / BDF Series

The BDS is a non-inductive thick film power resistor offering continuous powers up to 400 Watts (on a suitable heatsink). A modern functional package, with high voltage insulation and an excellent partial discharge rating.

#### Key Features

- Values R47 - 1M $\Omega$
- Voltage single shot 12kV
- Options for internal circuitry
- Non-inductive for fast switching
- Low partial discharge

#### Applications

- Snubbing (low inductance)
- Balancing resistor (multi resistor package)
- Filter (low inductance)
- High voltage
- High frequency

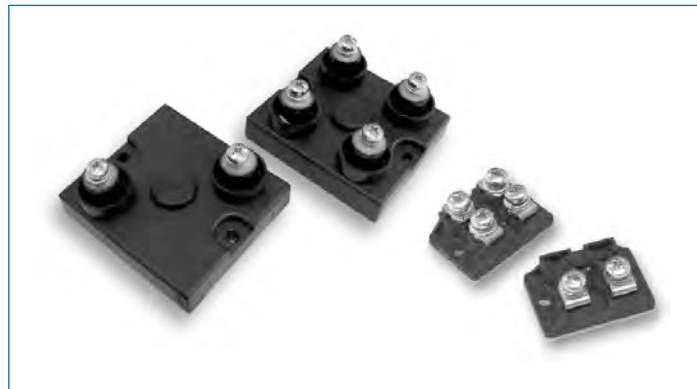

#### Characteristics - Electrical

	250 / 400W	100W (T0 227)
Resistance Range:	0R47-1M (4 terminal below 1R)	0R20-1M (4 terminal below 1R)
Resistance Tolerance:	$\pm 10\%$ , 5% (tighter by discussion)	$\pm 10\%$ , 5% (tighter by discussion)
TCR - R > 1 Ohm:	250ppm $^{\circ}$ C	250ppm $^{\circ}$ C
TCR - R < 1 Ohm:	150ppm $^{\circ}$ C	150ppm $^{\circ}$ C
Rated Power Heatsink Temperature at 100 $^{\circ}$ C:	250W (400W) at 70 $^{\circ}$ C	100W at 60 $^{\circ}$ C max heatsink
Parallel Capacitance:	40pf	40pf
Capacitance to Earth:	120pf	120pf
Series Inductance:	40nH maximum	40nH maximum
Limiting Element Voltage:	5kV max DC/AC rms	2.5kV DC/AC rms
Isolation Voltage (Terminal to Heatsink):	7kV DC/AC rms	2.5kV DC/AC rms
Single Shot 1.5/50 $\mu$ s:	up to 12kV	4.0kV
Insulation Resistance at 500V DC:	> 100g Ohms	> 100g Ohms
Partial Discharge:	< 5pC at 7kV	< 10pC at 2.5 kv
Endurance (Rated Power):	2000 cycles at rated power 30m/30m	$\Delta R$ 0.25% typically
Humidity Load Life:	56 days, 40 $^{\circ}$ C, 95%rh	$\Delta R$ 0.25% typically (i.r. 10g $\Omega$ )
Temperature Cycling:	-55 $^{\circ}$ C to +125 $^{\circ}$ C, 5 cycles	$\Delta R$ 0.25% typically
Operating / Storage Temperature:	-55 $^{\circ}$ C to +125 $^{\circ}$ C	
*Short Term Overload:	3 times rated power, 10 seconds	$\Delta R$ 0.25% typically *(4 times to order)
Vibration:	10/500 hz	$\Delta R$ 0.25% typically
Bump:	40g 4000	$\Delta R$ 0.25% typically

#### Dimensions

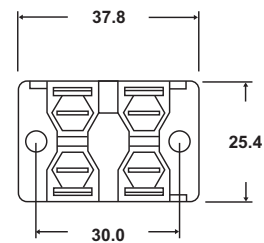
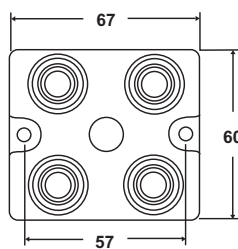



## Product Portfolio for the Railway Sector

### Type MPT Series

The MPT resistor series are a range of T0220 packaged, low inductance thick film power resistors which complement the thin film MPR series. This small size, high power device packaged in five case sizes are ideally suited to applications where high power dissipation yet small size are key design requirements. The MPT resistor series are the ideal solution for small snubber circuits, the output side of high speed pulse generators and low inductive resistor requirements in switch mode power supplies.

#### Key Features

- High power density
- Non inductive
- High power up to 100W
- Isolated moulded case
- Easy to mount

#### Applications

- Balancing
- Snubber
- Current sense
- In rush limiting



#### Characteristics - Electrical

	MPT20	MPT30	MPT35	MPT50	MPT100
Resistance Range:	R10 - 10K	R10 - 10K	R10 - 10K	R10 - 10K	R10 - 10K
Selection Series:	E24				
Rated Power with Suitable Heatsink:	20W	30W	35W	50W	100W
Rated Power without Heatsink:	3W	2.25W	2.5W	3W	3.5W
Maximum Operating Voltage:	350V				
Dielectric Strength:	1800VAC				
Insulation Resistance:	10G min.				
Operating Temperature Range:	-65°C to +150°C				-65°C to +175°C

#### Derating Curve

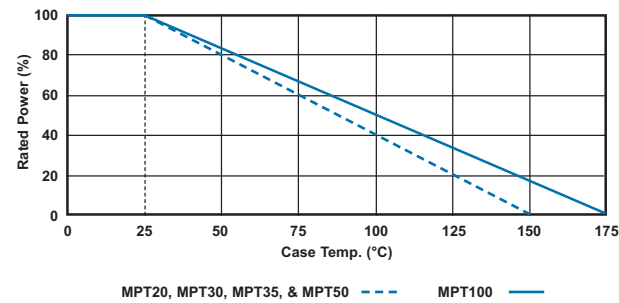

#### TCR / Tolerance Value Chart

Resistance Range / Tolerance	MPT 20 / 30 / 35 / 50		MPT100
	1% / 5% / 10%	0.5%	1% / 5% / 10%
R10 - 2R7	300ppm	-	300ppm
3R - 10R	100ppm	-	100ppm
3R - 10R	200ppm	-	200ppm
11R - 10K	50ppm	50ppm	50ppm
11R - 10K	100ppm	100ppm	100ppm
11R - 10K	200ppm	200ppm	200ppm

#### Dimensions

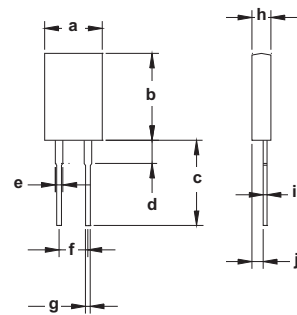

#### MPT30

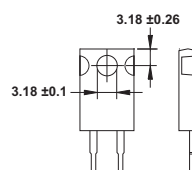

#### Mounting Detail

#### MPT35

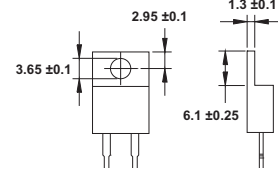

#### MPT100

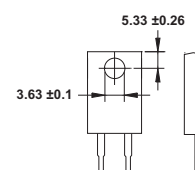

	a	b	c	d	e	f	g	h	i	j
MPT20	10.41 ±0.26	16.26 ±0.26	12.7 ±1.27	3.3 ±0.76	1.27 ±0.13	5.08 ±0.26	0.76 ±0.1	3.18 ±0.26	0.5 ±0.1	1.78 ±0.26
MPT30	10.41 ±0.26	16.26 ±0.26	12.7 ±1.27	3.3 ±0.76	1.27 ±0.13	5.08 ±0.26	0.76 ±0.1	3.18 ±0.26	0.5 ±0.1	1.78 ±0.26
MPT35	10.16 ±0.25	14.75 ±0.25	13.70 ±1.0	4.0	1.27 ±0.1	5.08 ±0.25	0.78 ±0.8	4.44 ±0.38	0.625 ±0.07	2.285 ±0.235
MPT50	10.41 ±0.26	16.26 ±0.26	12.7 ±1.27	3.3 ±0.76	1.27 ±0.13	5.08 ±0.26	0.76 ±0.1	3.18 ±0.26	0.5 ±0.1	1.78 ±0.26
MPT100	15.75 ±0.26	20.7 ±0.26	14.48 ±1.27	2.79 ±0.76	3.63 ±0.18	10.16 ±0.26	1.52 ±0.1	4.95 ±0.26	0.81 ±0.26	2.41 ±0.26



## Product Portfolio for the Railway Sector

### Type MPR Series

This small size non-inductive, high power resistor is an innovative and significant first for TE Connectivity. Occupying a standard T0220 package it is ideally suited to positions where high power dissipation, small size and tight tolerance are key design requirements. This series is an ideal solution for the output side of high speed pulse generators, a surge absorption resistor in switch mode power supplies and for monitors, display terminals, scientific workstations and other brown and white goods.

#### Key Features

- Small size (T0220 package)
- Non inductive
- High frequency range up to 300MHz
- High power 20W with suitable heatsink
- Voltage proof 2000V DC

#### Applications

- Balancing
- Snubber

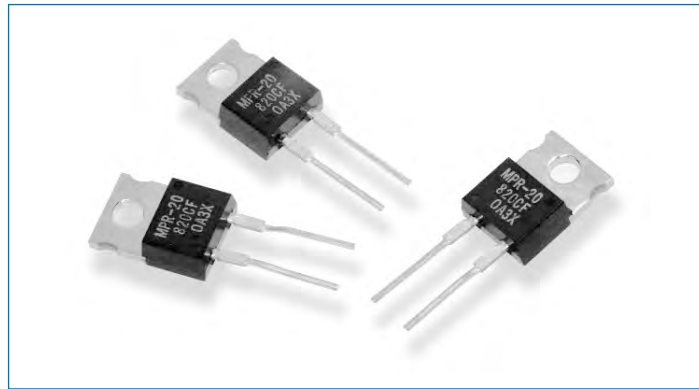

#### Characteristics - Electrical

Resistance Range:	R22 - R91	1R0 - 9R1	10R - 51K
Resistance Tolerance:	5%	5%	1% / 5%
Temp. Coefficient of Resistance (TCR):	250ppm/°C	100ppm/°C	50ppm/°C
Rated Power (on Suitable Heatsink):	20W		
Rated Power (with/without Heatsink):	2W * (See note below)		
Equivalent Parallel Capacitance:	1.0pF		
Maximum Operating Voltage:	500V DC		
Withstand Voltage:	2000V DC (Between terminals and heatsink)		
Operating Temperature Range:	-55°C to +155°C		
Rated Ambient Temperature:	-25°C to +40°C		

\* With a 5.8°C Watt heatsink or better at a 25°C ambient temperature, 20 Watts can be dissipated. A larger heatsink will allow the resistor to run at a lower temperature.

#### Derating Curve

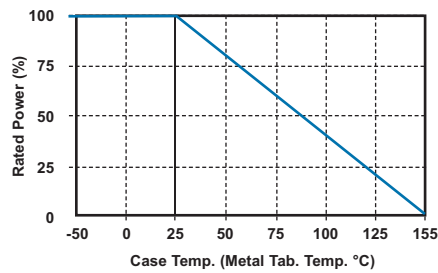

#### Load Life in High Temperature & Humidity

(70°C 95% DC Rated Power x 0.1) Continuous

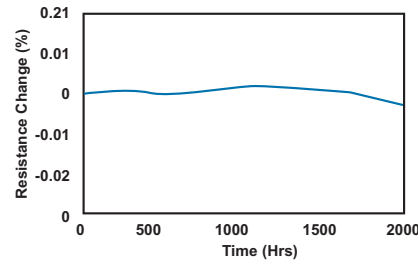

#### Dimensions

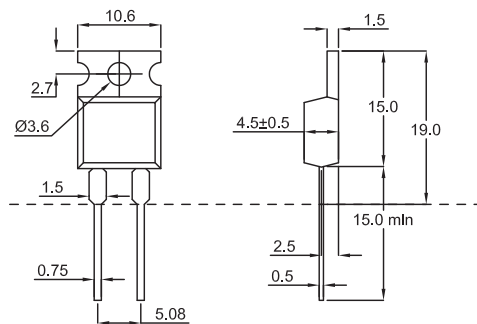

#### PCB Piercing Plan

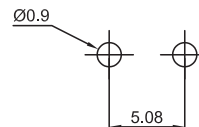



## Product Portfolio for the Railway Sector

### Type MPC Series

A range of non inductive thick film power resistors complementing the T0220 packaged MPR series (20W heat sink styles), being vertically mounted and suitable to dissipate power from 3W up to 10W. Available in values from 1R0 to 200K Ohms they are the idea solution for small snubber circuits, the output side of high speed pulse generators and low inductive resistor requirements in switch mode power supplies.

#### Key Features

- High power density
- Non inductive
- High power up to 10W
- Voltage proof 5000V DC
- Stable at 100ppm/°C

#### Applications

- Balancing
- Snubber
- Current sense
- Inrush limiting



#### Characteristics - Electrical

Resistance Values:	R10 to 200K
Resistance Tolerance:	1%, 5%
Temp. Coefficient of Resistance:	±100ppm/°C
Rated Power @ 70°C:	3 - 10W nominal
Equivalent Parallel Capacitance (100 MHz):	1.0pf
Maximum Operating Voltage:	300V AC
Withstanding Voltage:	5000V
Overload Current:	20 x rated current up to 8ms (ΔR ± 0.5%)

#### Derating Curve

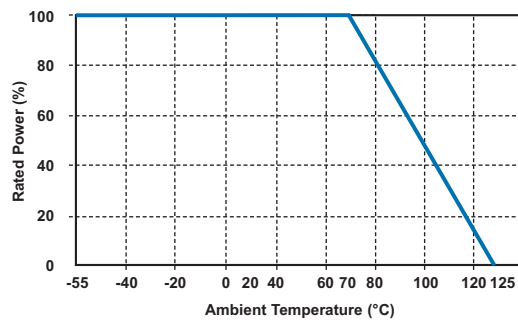

#### Overload Characteristics

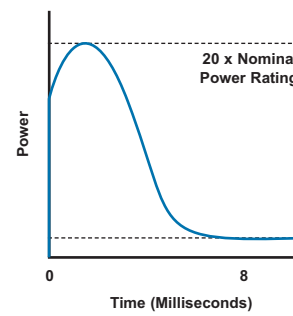

#### Dimensions

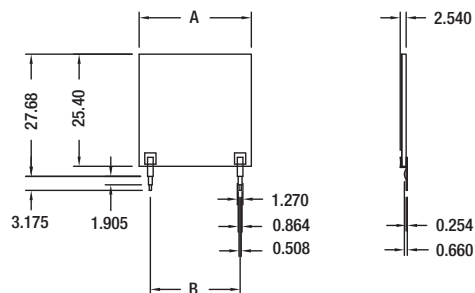

Size	MPC3	MPC5	MPC7	MPC10
A	10.16	12.7	19.05	25.4
B	5.08	5.08	12.70	20.32



## Product Portfolio for the Railway Sector

### Type SQ Series

This flexible range of power wire-wound resistors either have wire or power oxide film elements. The SQ series resistors are wound or deposited on a fine non-alkali ceramic core then embodied in a ceramic case and sealed with an inorganic silica filler. This design provides a resistor with high insulation resistance, low surface temperature, excellent TCR, and entirely fire proof construction. These resistors are ideally suited to a range of areas where low cost, and efficient thermal performance are important design criteria. Metal film cores adjusted by laser spiral are used where the resistor value is above that suited to wire. Similar performance is obtained although short time overload is slightly derated.



#### Key Features

- Choice of styles
- Bracketed types available
- Stable TCR 300ppm/°C
- Custom designs welcome
- Inorganic flame proof construction

#### Applications

- Capacitor pre-charge
- Capacitor discharge
- Inrush limiting

#### Characteristics - Electrical

	Test Condition	Performance
Resistance Temp. Coefficient:	-55°C ~ 155°C	± 300ppm/°C
*Short Time Overload:	10 times rated power for 5 seconds	± 2%
Rated Load:	Rated power for 30 minutes	± 1%
Voltage Withstand:	1000V AC 1 minute	no change
Insulation Resistance:	500V megger	1000meg
Temperature Cycle:	-30°C ~ 85°C for 5 cycles	± 1%
Load Life:	70°C on-off cycle for 1000 hours	± 5%
Moisture-proof Load Life:	40°C 95% RH on-off cycle 1000 hours	± 5%
Incombustibility:	16 times rated wattage for 5 minutes	No flame
Max. Overload Voltage:	2 times max. working voltage	
*Metal Film Elements:	Short time overload 5 times rated power, 5 seconds	

#### Derating Curve

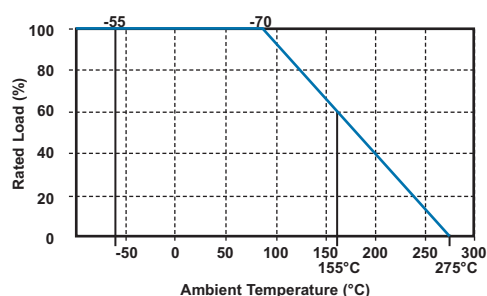

#### Load Against Temperature

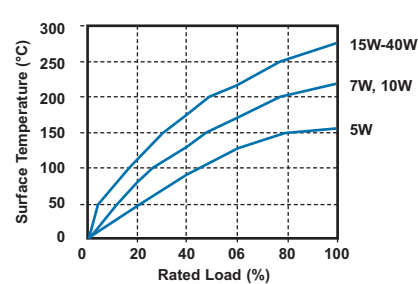

#### Dimensions - Type SQP - Horizontal

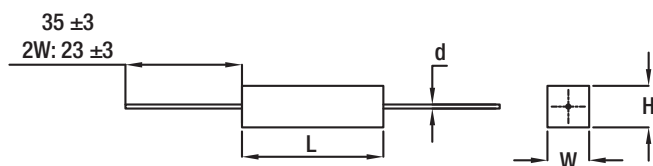

Power Rating	Dimensions					Resistance Range		Max. Working Voltage
	W±1	H±1	L±1.5	d±0.05	l±0.3	Wire	Metal Film	
2W	7	7	18	0.65	23	R10 - 82R	83R - 10K	150V
3W	8	8	22	0.8	35	R10 - 180R	181R - 33K	350V
5W	10	9	22	0.8	35	R10 - 180R	181R - 100K	350V
7W	10	9	35	0.8	35	R10 - 430R	431R - 100K	500V
10W	10	9	48	0.8	35	R10 - 470R	471R - 100K	750V
15W	12.5	11.5	48	0.8	35	R50 - 600R	601R - 150K	1000V
20-25W	14	13.5	60	0.8	35	R50 - 1K0	1.1K - 150K	1000V

Rated Continuous Working Voltage (RCWV)  
 RCWV:  $\sqrt{\text{Rated Power} \times \text{Resistance Value}}$  or Maximum Working Voltage listed above whichever is lower



## Product Portfolio for the Railway Sector

### Type SQ Series

#### Type SQH - Horizontal with Solder Lugs

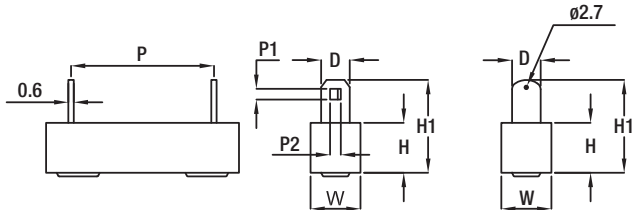

Power Rating	Dimensions					Resistance Range	
	W ±1	H ±1	L ±1.5	P	H1 ±1	Wire	Metal Film
10W	10	10	48	32 ±1	21	R50 - 600R	601R - 50K
15W	12.5	11.5	48	32 ±1	21	1R0 - 600R	601R - 50K
20W	14.5	13.5	60	42 ±1	24	1R0 - 1K0	1K1 - 50K
30W	19	19	75	55 ±2	31	1R0 - 2K0	-
40W	19	19	90	67 ±2	31	1R0 - 2K0	-

#### Type SQB - Horizontal with Solder Lugs & Bracket

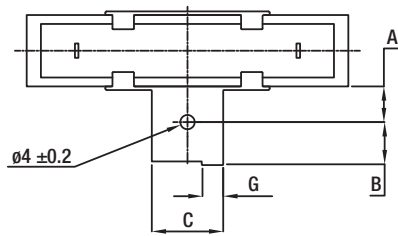

Power Rating	Dimensions			
	A ±0.5	B ±0.5	C ±0.5	G ±0.5
10W	8.0	5.0	12.0	3.0
15W	8.0	5.5	12.0	3.0
20W	8.0	5.5	12.0	3.0
30W	10.5	8.0	18.0	3.5
40W	10.5	8.0	18.0	3.5

#### Type SQZ - Horizontal Pluggable

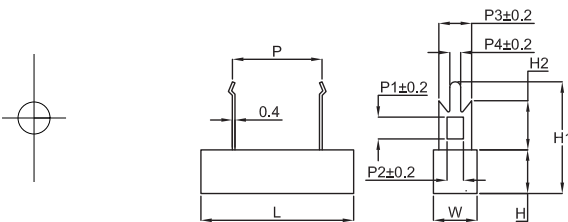

Power Rating	Dimensions										Resistance Range	
	W ±1	H ±1	L ±1.5	P1 ±1.5	P1	P2	P3	P4	H1 ±1	H2 ±1	Wire	Metal Film
5W	10	10	28	15	4.2	2	5	1.5	25	10.5	R10 - 130R	131R - 100K
7W	10	10	36	20	4.2	2	5	1.5	25	10.5	R10 - 430R	431R - 100K
10W	10	10	48	32	4.2	2	5	1.5	25	10.5	R20 - 470R	471R - 100K
15W	12.5	12	48	32	4.2	2	5	1.5	26	10.5	1R0 - 600R	601R - 150K
20W-25W*	15	13	60	42	7	6	10	2.7	36	15.0	1R0 - 1K0	1K1 - 150K

\*NB: 20W & 25W Devices Terminations are not crimped

#### Type SQM - Vertical

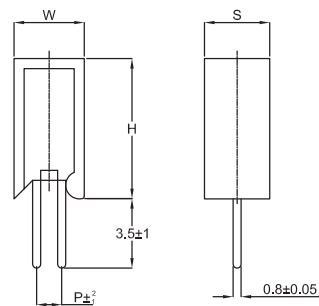

Power Rating	Dimensions				Resistance Range	
	W ±1	H ±1	S ±1.5	P ±2.0	Wire	Metal Film
2W	11	20	7	5	R10 - 82R	83R - 10K
3W	12	25	8	5	R10 - 180R	181R - 33K
5W	13	25	9	5	R10 - 180R	181R - 100K
7W	13	39	9	5	R10 - 430R	431R - 100K
10W	13	51	9	5	R10 - 470R	471R - 100K
10WS	16	35	12	7.5	R10 - 360R	361R - 100K

N.B. Custom design versions in wire at low tolerances, better TCR, and higher ohmic values are available to special order. Please enquire.

#### Type SPS - Vertical Mounting with Stabilising Bracket

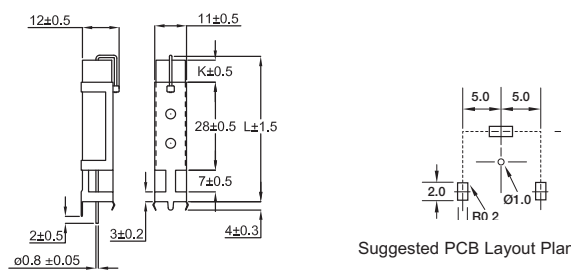

Power Rating	Dimension		Resistance Range	
	L ±1.5	K ±0.5	Wire	Metal Film
7W	48	8.5	R10 - 430R	431R - 100K
10W	60	20	R10 - 470R	471R - 100K



## Product Portfolio for the Railway Sector

### Type C Series

TE Connectivity has offered the C Series of vitreous enamelled wire-wound resistors for more than 25 years and as a result of continuous development and investment in the latest production equipment now supplies a product with a proven record of reliability and quality. These economically priced resistors are capable of dissipating high power from a relatively small size in harsh environmental conditions. The resistors are manufactured from quality materials for optimum reliability and stability.

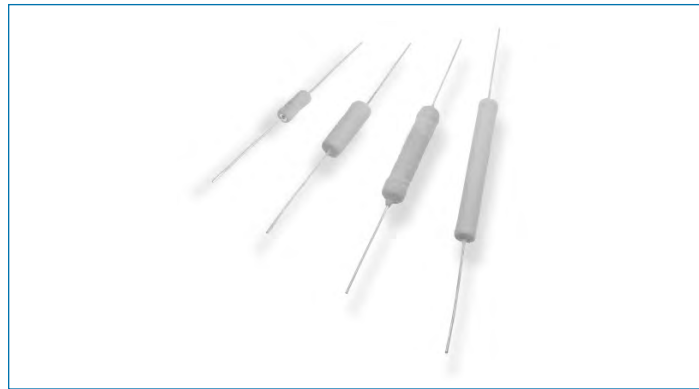

#### Key Features

- Vitreous enamel coated
- Up to 14W power
- All welded construction
- Overload 10 x 5 seconds
- Ammo packed or reeled (3 - 7W)

#### Applications

- Capacitor pre-charge
- Capacitor discharge
- Inrush limiting
- Balancing

#### Characteristics - Electrical

	C3A	C7	C10	C14
Wattage at 40°C:	4	7	10	14
Ohmic Value (min):	R10	R10	R10	R10
(max):	10K	27K	47K	100K
Limiting Element Voltage (DC/AC rms):	200	350	500	650
Resistance Tolerance:	10%, 5%, 2% (1% by request on a limited value range)			
Temperature Coefficient of Resistance (Ohmic Value):	Above 1R0 90ppm/°C			
Overload Resistance Change (up to 10x Rated Wattage for 5 Secs):	ΔR less than 1%			
Load Life Stability at Rated Wattage (resistance change):	1000 hours ΔR less than 3% 8000 hours ΔR less than 5%			
Shelf life stability (Resistance Change):	2 years ΔR less than 0.25%			
Power Derating:	Derate from 40°C linearly to zero at 350°C			

#### Surface Temperature v Power Dissipation

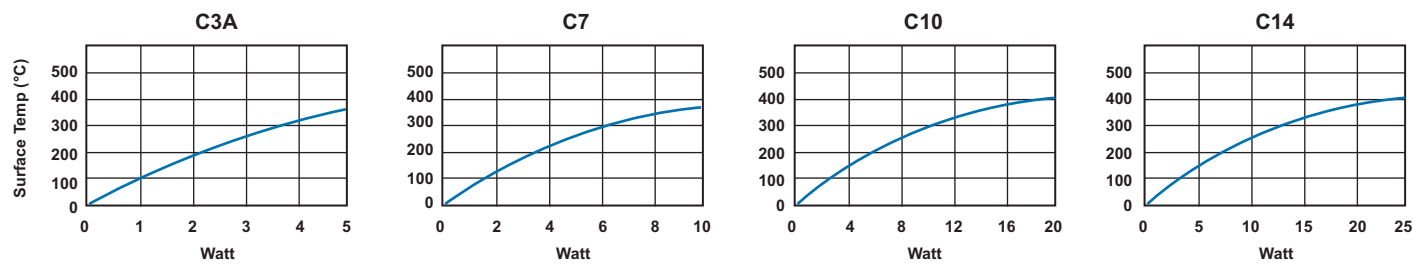

#### Dimensions

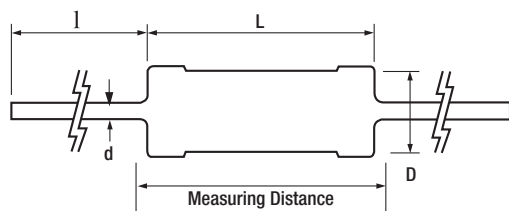

Type	L	D	d	I	Measuring Distance
C3A	13.0	5.7	0.8	35.0	30.7
C7	22.0	8.5	0.8	35.0	37.7
C10	38.1	8.5	0.8	35.0	52.8
C14	53.3	8.5	0.8	35.0	69.5



## Product Portfolio for the Railway Sector

### Type SBC Series

This range of power wire-wound resistors are wound on continuous glass fiber elements or have a ceramic core depending on resistance value. The element is housed in a ceramic case and sealed with an inorganic silica filler. Their construction gives a resistor with high insulation resistance and low surface temperature, capable of withstanding high overload currents. These resistors are ideally suited to a variety of applications within industrial and commercial environments, where performance and reliability are of prime importance. Applications include fan force ovens, cooker hoods, power supplies and triac based speed controls. Custom Design Variants in value and style are welcomed.



#### Key Features

- Vertical or axial mount
- Up to 17W
- Customer specials invited
- Fusible styles
- Widely available from distribution

#### Applications

- Pre-charge
- Discharge
- In rush limiting
- Pulse withstand

#### Characteristics - Electrical

Resistance Values:	Series E24 5% E12 10% (see tables for value limits per style)
Resistance Tolerance:	±5% ±10%
Maximum Continuous Voltage:	$\sqrt{P \times R}$
Load Life:	$\Delta R < \pm 3\%$ 1000 hours at 70°C
Power Rating:	See Surface Temperature Curve (below)
Temperature Coefficient of Resistance:	200ppm/°C (400ppm/°C below 18R)
Dielectric Strength:	2000V RMS

#### Surface Temperature Rise Curve

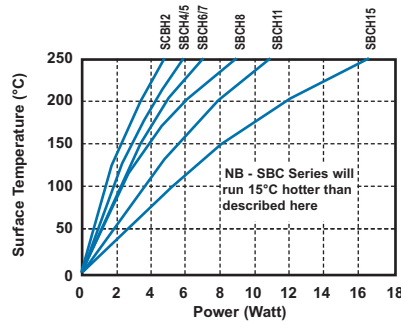

#### Derating Curve

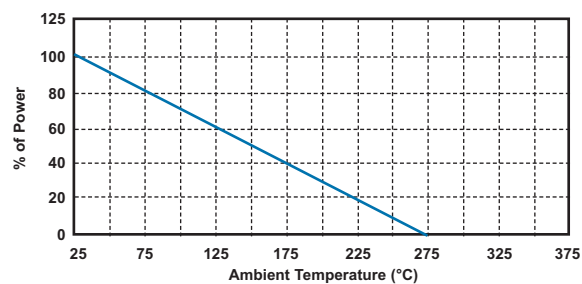

#### Dimensions

##### Type SBC (No Flutes in Ceramic)

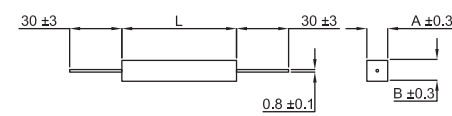

##### Type SBCH (Flutes in Ceramic)

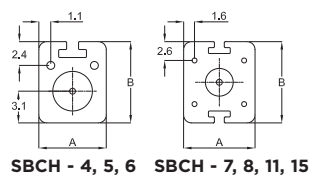

##### Type SBCLF (Externally Fused Style)

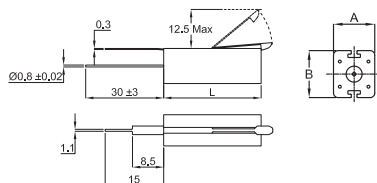

##### Type SBCV (Vertical Mount Style)

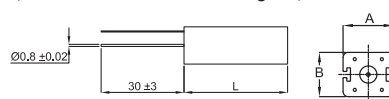

#### Ceramic Styles



Model	Power Max	Ohmic Values		Dimensions		
		Min	Max	A	B	L
SBC-2	4W	R20	6K8	6.4	6.4	20
SBC-4	5W	R30	10K	6.4	6.4	25
SBC-6	7W	R47	22K	6.4	6.4	38
SBC-8	9W	1R0	8K2	9	9	38
SBC-11	11W	1R0	22K	9	9	50
SBC-15	17W	1R0	22K	9	9	75
SBCH-4	4W	R20	6K8	7	8	20
SBCH-5	5W	R30	10K	7	8	25
SBCH-6	7W	R47	22K	7	8	38
SBCH-7	7W	R33	10K	9	10	25
SBCH-8	9W	1R0	8K2	9	10	38
SBCH-11	11W	1R0	22K	9	10	50
SBCH-15	17W	1R0	22K	9	10	75
SBCLF-4	4W	2R2	2K2	10	9	25
SBCLF-5	5.5W	2R2	5K6	10	9	38
SBCLF-7	7W	3R3	8K2	10	9	50
SBCLF-10	10W	4R7	12K	10	9	75
SBCV-6	7W	R47	22K	9	10	25
SBCV-8	9W	1R0	8K2	9	10	38
SBCV-11	11W	1R0	22K	9	10	50
SBCV-15	17W	1R0	22K	9	10	75





## Product Portfolio for the Railway Sector

### Type ER(V) / ES Series

A silicone coated power resistor. The ER series is suited to a wide range of industrial, control, medical and consumer applications and is available in a vertical mounting style. While very slightly larger than the ER series and manufactured to a marginally different specification, the ES series is suited to volume requirements in power supplies, process control instruments, communication equipment and other industrial positions.

#### Key Features

- Tough silicone coating
- Special pulse styles available
- 0.5% tolerance available
- Resistant to most solvents
- Vertical mount styles available
- Custom designs welcomed
- 0.5W - 10W sizes

#### Applications

- Capacitor pre-charge
- Capacitor discharge
- Inrush limiting
- Balancing



#### Characteristics - Electrical

	ES0.5W	ES1W	ES2W	ES3W	ES3WY	ES5W	ES6W	ES7W	ES8W	ES10W	ER74	ER58	ER16	ER17	ERV74	ERV58	ERV16
Power Rating at 20°C (W):	1/2	1	2	3	3	5	6	7	8	10	-	-	-	-	3*	7*	11*
Power Rating at 40°C (W):	-	-	-	-	-	-	-	-	-	-	3	7	11	14	-	-	-
Power Rating at 70°C (W):	-	-	-	-	-	-	-	-	-	-	2.5	6	9	12	1.5*	3*	5*
Resistance Range:	R05-68R	R05-100R	R05-150R	R05-200R	201R-470R	R10-390R	R10-1K0	R10-1K5	R10-2K2	R10-3K3	R03-10K	R05-20K	R13-68K	R20-100K	R10-3K9	R10-6K8	R15-27K
Dielectric Withstand Voltage:	350V	500V	500V	500V	500V	500V	500V	500V	800V	1000V	-	-	-	-	-	-	-
Max. Element Volts:	-	-	-	-	-	-	-	-	-	-	100V	200V	500V	700V	100V	200V	500V

\* When mounted in the horizontal and vertical plane only - inverted mounting may result in heat damage of the PCB - Please contact your local Product Information Center or go to [te.com/help](http://te.com/help)

#### Power Ratings Dissipation / Ambient Temperature

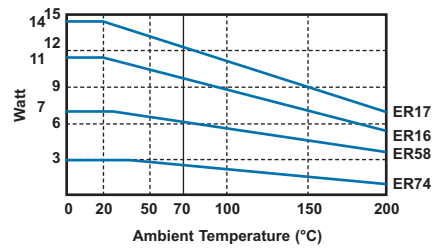

#### Power Ratings Hot Spot Temperature @ 40°C

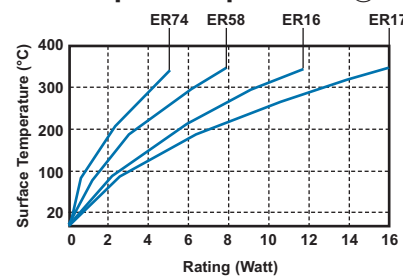

#### Surface Temperature Vs Power

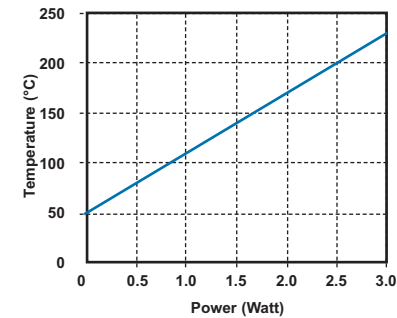

#### Dimensions

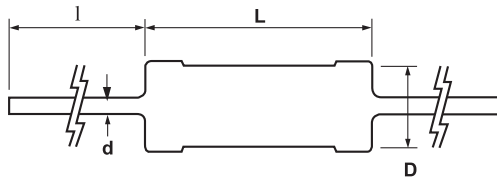

Type	ES0.5W	ES1W	ES2W	ES3W	ES3WY	ES5W	ES6W	ES7W	ES8W	ES10W	ER74	ER58	ER16	ER17
D	3.0 ±1.0	4.0 ±1.0	5.0 ±1.0	5.5 ±1.0	6.0 ±1.0	6.5 ±1.0	8.5 ±1.0	8.5 ±1.0	8.5 ±1.0	8.5 ±1.0	6.0	8.0	8.0	8.0
L	9.0 ±1.5	9.0 ±1.5	11.0 ±1.5	13.0 ±1.5	17.0 ±1.5	20.0 ±1.5	25.0 ±1.5	32.0 ±1.5	41.0 ±1.5	53.0 ±1.5	13.5	22.2	38.1	53.5
I	30.0 ±3.0	30.0 ±3.0	30.0 ±3.0	38.0 ±3.0	38.0 ±3.0	38.0 ±3.0	38.0 ±3.0	38.0 ±3.0	38.0 ±3.0	33.0 ±3.0	38.0	38.0	38.0	38.0
d	0.65 ±0.05	0.65 ±0.05	0.80 ±0.05	0.80 ±0.05	0.80 ±0.05	0.80 ±0.05	0.80 ±0.05	0.80 ±0.05	0.80 ±0.05	0.80 ±0.05	0.8	0.8	0.8	0.8

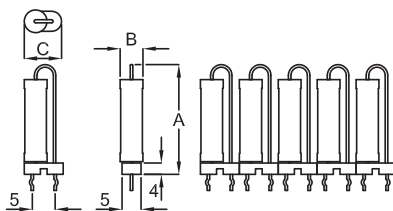

Type	A	B	C
ERV74	19.0	5.6	9.7
ERV58	29.0	8.0	10.6
ERV16	43.0	8.0	10.6

- Resistance measured 6mm either side of body.
- Supplied in standard packs in arrays of 5 resistors with snap links for handling.



## Product Portfolio for the Railway Sector

### Type SBL Series

The SBL series is a low ohmic non-inductive resistor with a low temperature coefficient in a fully insulated ceramic housing. It is ideal for applications in power supply regulation, motor control current monitoring, feedback control loops, overload sensors and radio frequency applications. The solid metal element has welded copper terminals and is encapsulated in a ceramic housing, filled with compressed silica sand.

#### Key Features

- 4W & 5W versions
- Solid metal element
- Non-inductive
- Low temperature coefficient
- 4W device available in distribution

#### Applications

- Current sense

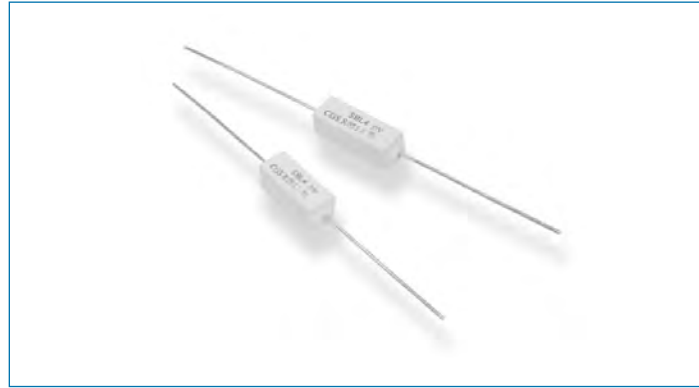

#### Characteristics - Electrical

Resistance Values (4W):	R005, R01, R015, R018, R022, R033, R047, R051
Resistance Values (5W):	R01, R015, R018, R022, R033, R047, R051
Resistance Tolerance:	± 5%
Rated Dissipation (4W):	4W at 70°C
Rated Dissipation (5W):	5W at 70°C
Dielectric Strength:	2000V

#### Temperature Co-Efficient of Resistance

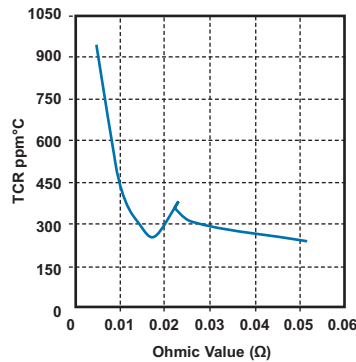

#### Temperature Rise

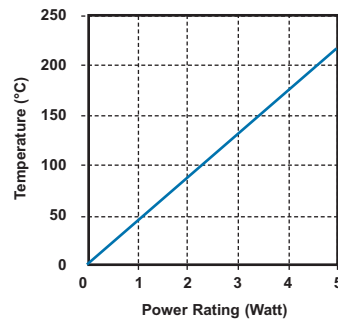

#### Derating Curve

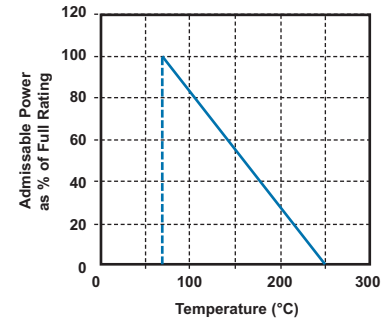

#### Dimensions

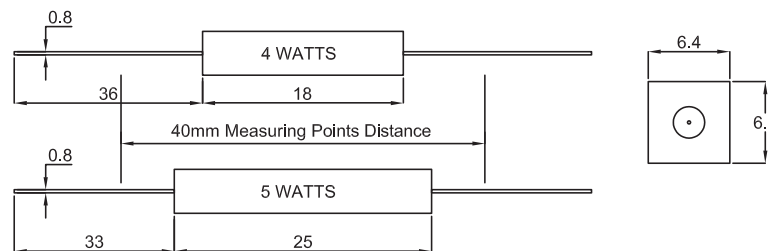



## Product Portfolio for the Railway Sector

### Type YP Series

The YP series resistors are coated a multilayer silicone and the terminals are designed for quick and easy mounting on capacitors and have a mounting pitch of 22.2 and 31.8 mm. These are wire-wound ceramic core resistors designed for voltage balancing of series connected aluminium electrolytic capacitors. These resistors are also suitable for capacitor voltage discharge safety applications in high voltage circuits. Ideally suited for industrial grade capacitors.

#### Key Features

- Flameproof silicone coating
- Stainless steel mounting terminals for direct mounting on capacitors
- Direct mounting onto capacitors
- Custom designs possible
- Innovative design

#### Applications

- Capacitor pre-charge
- Capacitor discharge
- Inrush limiting



#### Characteristics - Electrical

Resistance Values:	2K, 10K, 18K, 27K, 47K. Other values on request and to order
Resistance Tolerance:	±5%
Temperature Coefficient:	±30ppm/°C (typ.), ±100ppm/°C (maximum)
Maximum Voltage:	825V DC or AC rms for YP10, 570V for YP8
Derating:	Derated linearly to zero at 350°C
Power Rating:	10W @ 70°C for YP10 and 8W @ 70°C for YP8
Stability:	70°C, 1000hr - R/R @ 100% load <±5%
Standard:	Performance as per BS - CECC 40201-002
Marking:	Type, resistance value, tolerance

#### Dimensions

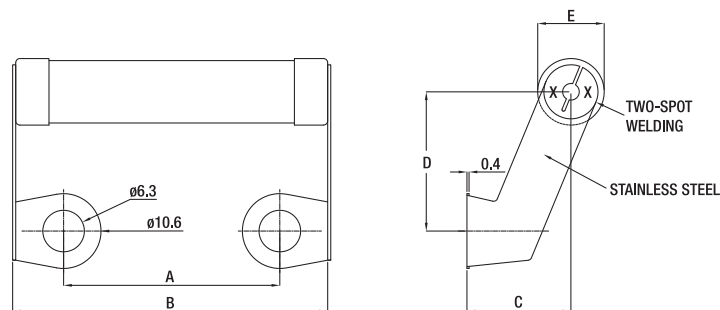

Type	A ±1mm	B max.	C ±1mm	D ±1mm	E ±1mm
YP8	22.2	40	15	21	9.5
YP10	31.8	50	15	21	9.5



## Product Portfolio for the Railway Sector

### Type HVR Series

TE Connectivity supplies high specification power resistors for specialist applications. The HVR range consists of high power, high voltage resistors capable of operating up to 50kV (continuous) and dissipating 50W in air or 100W oil. The thick film resistor element is designed to minimise inductance and capacitance giving optimum performance at MHz frequencies, and resistance to high voltage surges.

#### Key Features

- Highly versatile product
- 50kV continuous operating voltage
- Low inductance and capacitance
- Established product

#### Applications

- High frequency switching (MHz)
- Balancing
- Voltage divider
- High voltage



#### Characteristics - Electrical

	HVR10	HVR20	HVR30	HVR50
Ohmic Value min/max (Ω):	2K0-1G0	2K0-1G0	2K0-1G0	2K0-1G0
Resistor Tolerance - standard (%):	10%	10%	10%	10%
Options (R<400M):	5%, 1%	5%, 1%	5%, 1%	5%, 1%
Power Dissipation at 20°C (W):	5W	15W	25W	50W
At 70°C:	3W	10W	15W	25W
In Oil at 20°C:	10W	30W	50W	100W
Continuous Operating Voltage max (V):	10kV	20kV	30kV	50kV
Temperature Coefficient of Resistance 20°C to 70°C (ppm/°C):	< ±300ppm/°C	< ±300ppm/°C	< ±300ppm/°C	< 300ppm/°C
Voltage Coefficient of Resistance - V > 100V (%):	< ±2%	< ±2%	< ±2%	< ±2%
Stability ΔR - 1000h load life (%):	< ±2%	< ±2%	< ±2%	< ±2%

#### Derating Curve

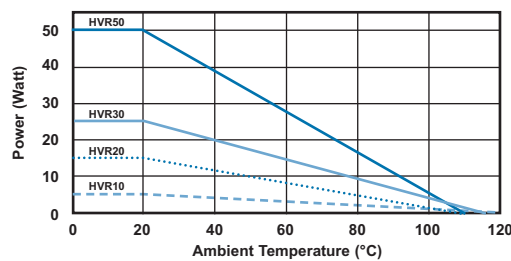

#### Surface Temperature Rise

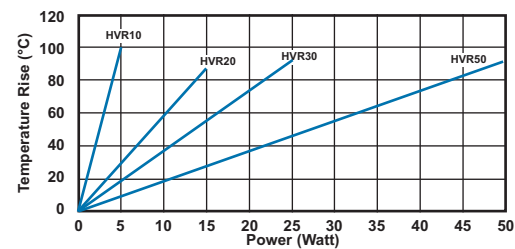

#### Dimensions

##### Style B

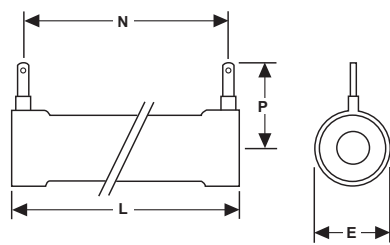

##### Style B

Type	A	E	L	N	P
HVR10	6.3	12.0	60.0	53.2	18.2
HVR20	10.0	22.6	120.0	109.0	27.0
HVR30	17.5	30.6	120.0	109.0	34.0
HVR50	17.5	30.6	240.0	229.0	34.0

##### Style D

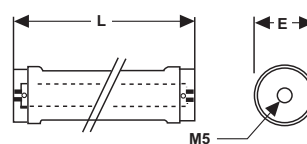

##### Style C

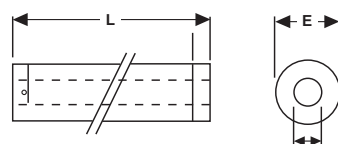

##### Style C

Type	A	E	L	N	P
HVR10	6.3	10.5	60.0	-	-
HVR20	10.0	20.2	120.0	-	-
HVR30	17.5	28.2	120.0	-	-
HVR50	17.5	28.2	240.0	-	-

##### Style D

Type	A	E	L	N	P
HVR10	6.3	10.0	70.0	-	-
HVR20	10.0	21.5	140.0	-	-
HVR30	17.5	30.0	140.0	-	-
HVR50	17.5	30.0	260.0	-	-



## Product Portfolio for the Railway Sector

### Type HB Series

TE Connectivity supplies standard and custom designed high value/high voltage resistors for high voltage, industrial, control, medical and general-purpose use. The HB is a tough epoxy coated high voltage resistor, with axial or radial leads, values up to 1GΩ and an operational voltage to 20kV as standard and 30kV to order. The resistors are made from quality materials for optimum reliability and stability. TE Connectivity can test resistors to conform to relevant international, MIL or customer specifications. TE Connectivity offers advise on the use of resistors for high frequency applications and to supply information for high voltage use. Please contact your local Product Information Center or go to [te.com/help](http://te.com/help)



#### Key Features

- Up to 15kV element voltage
- High ratio of size to power
- 1kΩ to 1GΩ
- Low inductance
- Established proven reliability

#### Applications

- High voltage divider
- Surge
- Filter
- Balancing
- Inrush limiting

#### Characteristics - Electrical

	HBA	HB1	HB3
Power Dissipation - Power @ 20°C (70°C) (W):	0.8 (0.4)	2.0 (1.0)	4.0 (2.0)
Ohmic Value - min/max (Ohms):	1K-120M	10K-1G	10K-1G
Resistance Tolerance (%) (Tighter by Request):	1%, 2%, 5%	1%, 2%, 5%	1%, 2%, 5%
Maximum Working Voltage - DC or ACrms (Volts):	1kV	7.5kV	15kV
Insulation Resistance - Epoxy Coated, @500V DC (Ohms):	>10 <sup>6</sup> MΩ	>10 <sup>6</sup> MΩ	>10 <sup>6</sup> MΩ
Temperature Coefficient (ppm/°C):	±100ppm/°C	±100ppm/°C	±100ppm/°C
(±20ppm/°C Available to Special Order)			
Voltage Coefficient:	Negligible up to 100K		Negligible up to 200K
	Increasing to 0.02ppm/Volt at 800K		Increasing to 0.01ppm/Volt at 1M0
	Increasing to 1.0ppm/Volt at 5M0		Increasing to 1.0ppm/Volt at 10M
	Increasing to 2.0ppm/Volt at 50M		Increasing to 2.0ppm/Volt at 100M
	Increasing to 8.0ppm/Volt at 100M		Increasing to 8.0ppm/Volt at 1000M
Ambient Temperature Range (°C):	-55 to 125	-55 to 125	-55 to 125
Encapsulation:	Epoxy coating (Optional)		

#### Derating Curve

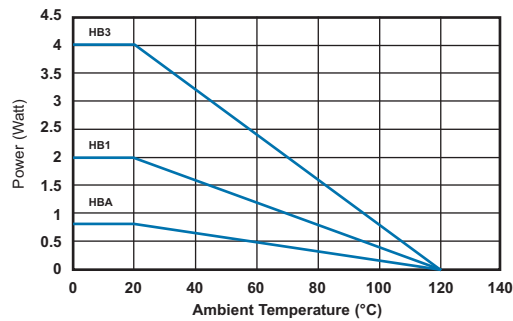

#### Surface Temperature Rise

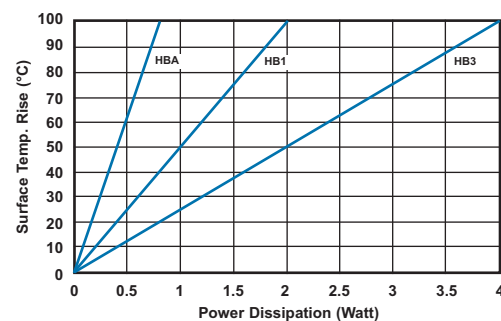

#### Dimensions

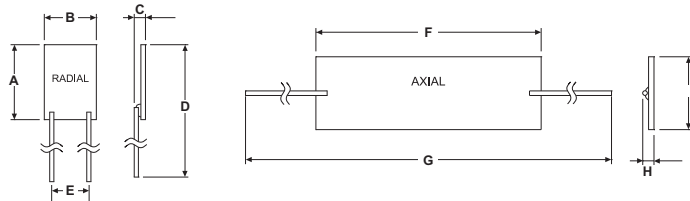

Type	A	B	C	D	E	F	G	H	I
HBA	Uncoated	10.2	7	1.75	60.2	5.0	-	-	-
	Epoxy Coated	12.5	8	2.6	60.5	5.0	-	-	-
HB01	Uncoated	8.4	26	1.5	33.8	22.9	26	66	1.5
	Epoxy Coated	10.4	26.5	3.0	35.8	22.9	26.3	66	3
HB03	Uncoated	8.4	51.1	1.5	33.8	48.3	51.1	91.1	1.5
	Epoxy Coated	10.4	52	3.0	35.8	48.3	53.5	91.1	3

Lead Length: minimum 20mm  
Lead Diameter: Nominal 0.6 ±0.05mm



## Product Portfolio for the Railway Sector

### Type HH / HJ Series

The HH type resistors offers a very stable high voltage resistor in a compact package with excellent pulse withstand capability. These are used mainly in physical and chemical measuring instruments, X-ray apparatus, electron microscopes and other high voltage industrial applications. The HJ type resistors have higher reliability when they are mounted on board, and excellent long-term stability. These are used mainly in semiconductor equipments, X-ray apparatus, and many other measuring instruments.



#### Key Features

- Low TCR's
- Close resistance tolerances
- Small compact size
- Excellent long-term stability
- High resistance to pulse voltages
- Special coatings for high humidity
- High thermal shock resistance

#### Applications

- Balancing

#### Characteristics - Electrical

Type	Power Rating @ 25°C (Watt)	Max. Working Voltage DC (kV)	Impulse Voltage (kV) 1.2 x 50 Microseconds	Resistance Range (Ohms)	Resistance Tolerance (%)	Temperature Coefficient (ppm)
HJ55	0.25W	0.75	1.5	100K-100M	0.1, 0.25	±25, ±50, ±100
HJ60	0.5W	1.5	3.0	100K-100M	0.1, 0.25	±25, ±50, ±100
HJ65	1.0W	2.0	4.0	100K-100M	0.1, 0.25	±25, ±50, ±100
HJ70	2.0W	5.0	10.0	100K-100M	0.1, 0.25	±25, ±50, ±100
HJ80	3.0W	10.0	20.0	1M-100M	0.1, 0.25	±25, ±50, ±100
HH55	0.5W	1.5	3.0	100K-100M	1.0, 2.0, 5.0, 10	±25, ±50, ±100
HH60	1.0W	2.0	4.0	100K-500M	1.0, 2.0, 5.0, 10	±25, ±50, ±100
HH65	2.0W	5.0	10.0	100K-500M	1.0, 2.0, 5.0, 10	±25, ±50, ±100
HH70	3.0W	10.0	20.0	100K-500M	1.0, 2.0, 5.0, 10	±25, ±50, ±100
HH80	4.0W	15.0	30.0	100K-500M 100K-2G0	1.0, 2.0, 5.0, 10	±50 ±100
HH120	6.0W	20.0	40.0	100K-500M 100K-2G0	1.0, 2.0, 5.0, 10	±50 ±100

#### Derating Curve

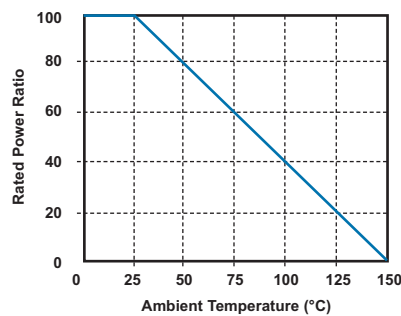

#### Dimensions

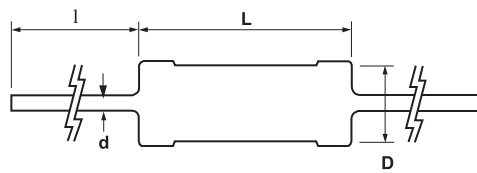

Style	D±1.0	L±1.0	d±0.05	l min
HH55	4.5	13.0	0.8	38.0
HH60	4.5	14.5	0.8	38.0
HH65	5.5	26.5	1.0	38.0
HH70	5.5	42.0	1.0	38.0
HH80	8.5	52.0	1.0	38.0
HH120	8.5	77.0	1.0	38.0

Style	D±1.0	L±1.0	d±0.05	l min
HJ55	3.0	9.0	0.6	38.0
HJ60	4.5	13.0	0.8	38.0
HJ65	4.5	14.5	0.8	38.0
HJ70	5.5	26.5	1.0	38.0
HJ80	8.5	42.0	1.0	38.0



## Product Portfolio for the Railway Sector

### Type RGP Series

Metal glaze resistors are manufactured using thick film techniques. The ceramic slugs have the thick film applied, the film is fired and end caps are forced onto the slugs, the resistive element is spiralled to value and lead wires are welded onto the end caps. Four layers of coating are applied - the first being a phenolic resin, the other three being epoxy.

#### Key Features

- Stable thick film elements
- High working voltages
- High ohmic values

#### Applications

- Balancing
- Snubber



#### Characteristics - Electrical

	RGP0207CH	RGP50	RGP100	RGP200	RGP300	RGP400
Rated Power @ 70°C (W):	0.25	0.5	1	2	3	4
Resistance Range (Ohms) min:	1M0	1M0	1M0	1M0	1M0	1M0
max:	1G0	3G0	5G0	5G0	10G	10G
Tolerance (%):	5 10					
Code Letter:	J K					
Temp. Coefficient max (ppm/°C):	±350					
Selection Series:	E24					
Limiting Element Voltage (V):	750	1K0	1K5	5K0	10K	15K
Maximum Overload Voltage (V):	1K0	1K5	2K5	7K5	15K	20K
Operating Temp. Range (°C):	-55 to +155					
Climatic Category:	55/155/56					
Voltage Coefficient (±%/V):	0.005					
Typical Noise at 47MΩ:	0.75					
Dielectric Strength (V):	300					
Insulation Resistance (MΩ):	1000					

#### Derating Curve

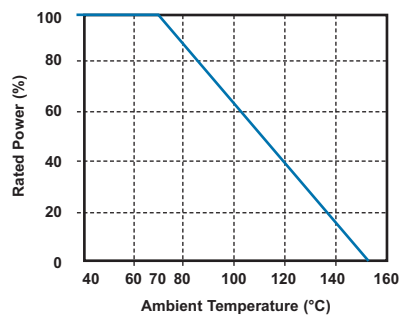

#### Dimensions

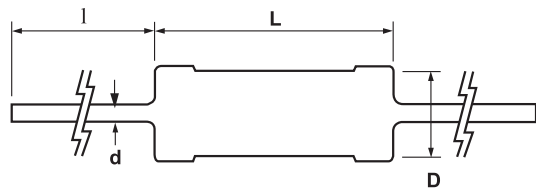

Style	L ± 1	D ± 0.5	d ± 0.1	l ± 2
RGP0207CH	6.5	2.5	0.6	28
RGP50	13.0	4.5	0.8	38
RGP100	14.5	5.5	0.8	38
RGP200	27.0	7.0	0.8	38
RGP300	42.0	7.0	0.8	38
RGP400	52.0	8.0	1.0	38



## Product Portfolio for the Railway Sector

### Type RR Series

The RR Series is manufactured by depositing a homogeneous film of metal alloy onto a high-grade ceramic body. After a helical groove has been cut in the resistive layer, tinned connecting wires of electrolytic copper are welded to the end-caps. The resistors are coated with a red, non-flammable lacquer, which provides electrical, mechanical and climatic protection.

#### Key Features

- Metal film technology
- High power, small package
- Excellent long-term stability
- High surge/overload capability
- High stability/reliability

#### Applications

- Pre-charge
- Discharge
- Snubbing
- Balancing
- Pulse withstand



#### Characteristics - Electrical

	RR01 1W		RR02 2W		RR03 3W	
Resistance Range:	0.22Ω-1MΩ	10R - 1M0	0.33Ω-1MΩ	10R - 1M0	0.33Ω-1MΩ	10R - 1M0
Tolerance and Series:	±5%, E24	±1%, E24/E96	±5%, E24	±1%, E24/E96	±5%, E24	±1%, E24/E96
Temperature Coefficient:	±300ppm/°C					
Limiting Voltage (DC or RMS):	350V		500V		750V	

#### Derating Curve

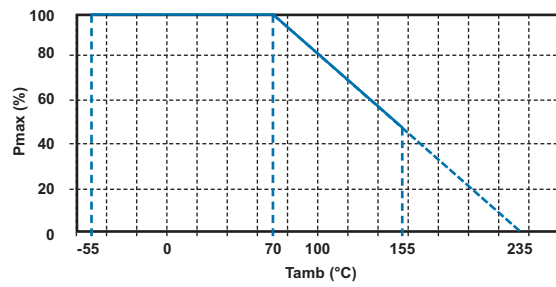

Maximum dissipation (Pmax) in percentage of rated power as a function of ambient temperature (Tamb)

#### Fusing Characteristics

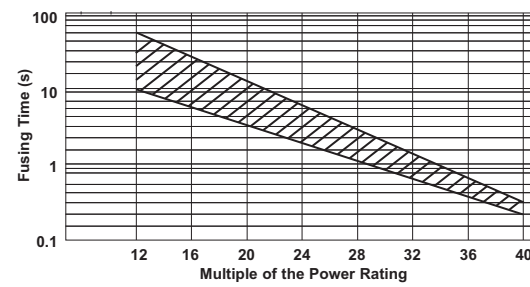

#### Pulse Characteristics

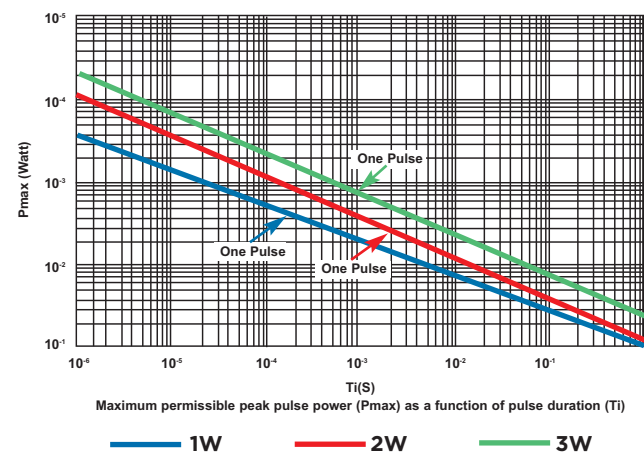

Condition test: Resistance change  $\leq \pm 5\%$  with pulse 1000 cycles as like the figure (reference only).

1. Added power and added voltage are within the lower territory of this graph.
2. Added in normal temperature and humidity.

#### Dimensions

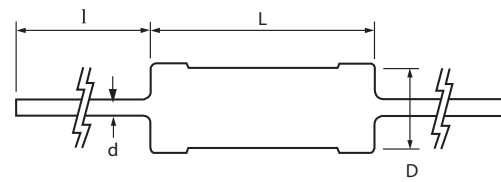

	L ±1	øD ±0.5	ød ±0.1	l ±3
RR01	6.8	2.6	0.65	30
RR02	9.0	3.5	0.8	30
RR03	15.0	5.0	0.8	30

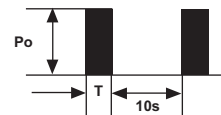





## Product Portfolio for the Railway Sector

### Type ROX Series

The resistive element comprises a metal oxide film deposited on a ceramic former. The element is protected by a flameproof coating which will withstand overload conditions without flame or mechanical damage. They are recommended for use in applications such as line protection.

#### Key Features

- High power, small size
- Complete flameproof construction
- High surge/overload capability
- Special lead formations possible
- Custom lead forming

#### Applications

- Capacitor pre-charge
- Capacitor discharge
- Balancing
- Snubber

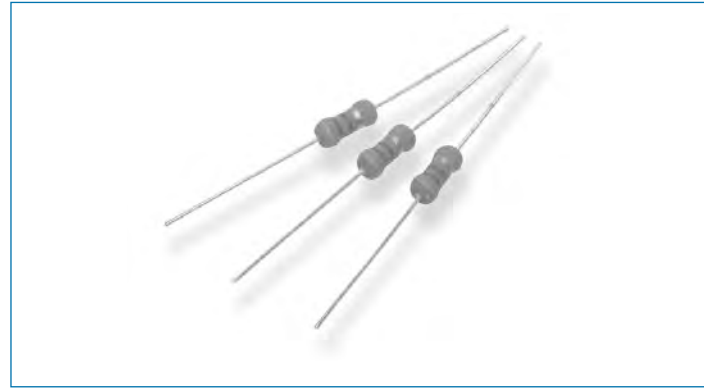

#### Characteristics - Electrical

	ROX05	ROX1	ROX2	ROX05S	ROX1SS	ROX1S	ROX2S	ROX3S	ROX5S
Rated Power @ 70°C (W):	0.5	1	2	0.5	1	1	2	3	5
Resistance Range min/max(Ω)	0.1-330K	0.1-470K	0.1-560K	0.1-100K	0.1-200R	0.1-270K	0.1-470K	0.1-560K	0.1-560K
Tolerance and Code Letter:	2% (G) / 5% (J)			1% (F) available on request					
Temp. Coefficient max (ppm/°C):	± 350								
Limiting Element Voltage (V):	250	350	350	250	350	350	350	350	500
Maximum Overload Voltage (V):	400	600	600	400	400	600	600	600	800
Max Intermittent Overload Voltage (V):	500	750	750	500	500	750	750	750	1500
Dielectric Strength (V):	250	350	350	250	350	350	350	350	500

#### Derating Curve

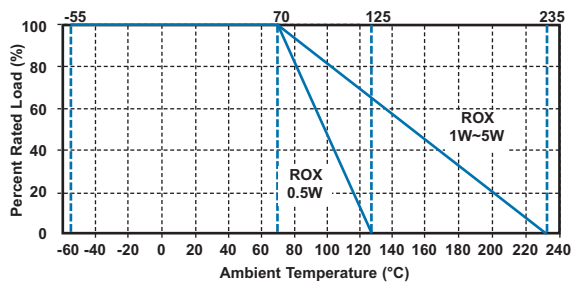

#### Heat Rise Chart

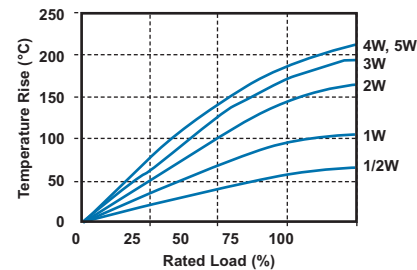

#### Dimensions

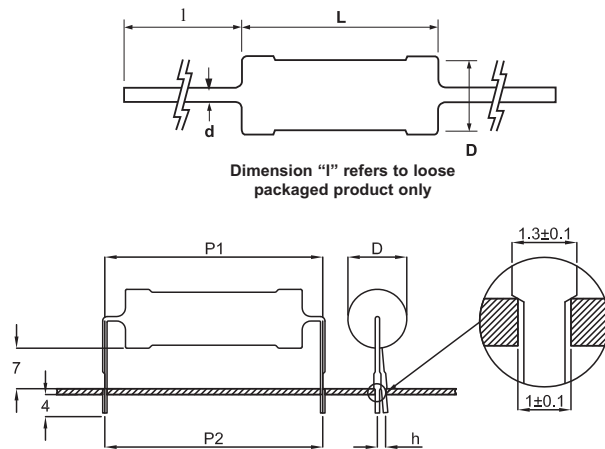

#### Standard Range Ledged

Style	D max	L Max	l±3	d±0.05
ROX05	3.5	10	28	0.54
ROX1	5	12	25	0.7
ROX2	5.5	16	28	0.7

#### Standard Range Pre-formed

Style	P1 ±0.5	P2 ±2	H1	H2	h max
ROX05	12.5	12.5	7.5±1.5	3.5±1	2.0
ROX1	15	15	7.5±1.5	3.5±1	2.0
ROX2	20	20	7.5±2.0	3.5±1	3.0

#### "S" Range Ledged

Style	D max	L Max	l+/-3	d+/-0.05
ROX05S	2.5	7.5	28	0.54
ROX1SS	2.5	7.5	28	0.54
ROX1S	3.5	10	28	0.54
ROX2S	5	12	25	0.7
ROX3S	5.5	16	28	0.7
ROX5S	8	25	38	0.75

#### "S" Range Pre-formed

Style	P1 ±0.5	P2 ±2	H1	H2	h max
ROX05S	10	10	7.5±1.5	3.5±1	2.0
ROX1SS	10	10	7.5±1.5	3.5±1	2.0
ROX1S	12.5	12.5	7.5±0.5	3.5±1	2.0
ROX2S	15	15	7.5±1.5	3.5±1	2.9
ROX3S	20	20	7.5±2.0	3.5±1	3.0
ROX5S	30	30	7.5±2.0	3.5±1	3.0



## Product Portfolio for the Railway Sector

### Type CBT / CCR Series

The CBT and CCR Series of resistors are constructed utilising solid carbon or ceramic composition, which is the traditional medium for absorbing high energy pulses, in cases of high inrush current. These resistors have evolved over many years to have excellent pulse withstand capabilities, whilst remaining very stable. These improved characteristics have been achieved by prudent selection of materials of optimum physical properties and by advances in manufacturing process.

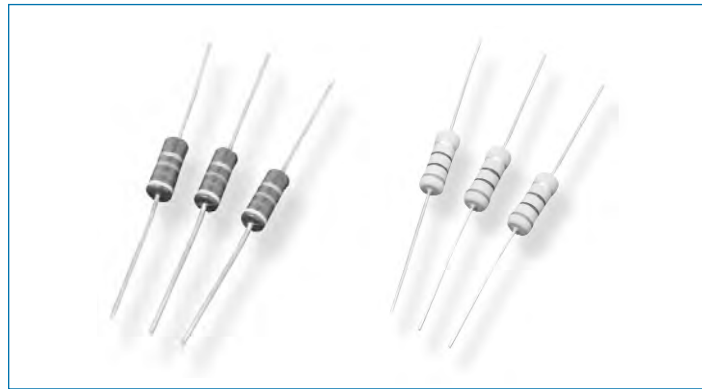

#### Key Features

- Ceramic or carbon element
- Designed for pulse withstand
- Solid element construction
- High performance
- 0.25W to 2.0W dissipation

#### Applications

- R-C Snubber circuits
- HV power supplies
- Inrush limiting
- Surge protection

#### Characteristics - Electrical

	CBT25	CBT50	CCR1/2	CCR1	CCR2
Power at 70°C Ambient:	0.25W derating to 0 at +125°C	0.5W derating to 0 at +125°C	0.5W derating to 0 at +200°C	1W derating to 0 at +200°C	2W derating to 0 at +200°C
Maximum Voltage:	250 V	350 V	200V	300V	400V
Resistance Range:	1R0 - 5M6	1R0 - 22M	10R - 100K	3R3 - 390K	3R3 - 390K
Resistance Values:	5% E24 Series/10% E12 Series/20% E6 Series		10% E12 series	10% E12 series	10% E12 series
Voltage Coefficient:	± 0.035%/V	± 0.035%/V	-	-	-
Limiting Element Voltage:	250 V	350 V	-	-	-
Maximum Overload Voltage:	400 V	700 V	400V	600V	800V
Dielectric Withstand Voltage:	-	-	500 V	500 V	700 V
Impulse Withstanding Voltage*:	-	-	10 Kv	14 Kv	20 Kv
Temperature Coefficient (ppm/°C):	-	-	<100R: -900 to ±300	>100R: -1300 to ±300	>100R: -1300 to ±300

NB \*: Please refer to Resistance to Pulse Circuit

#### Pulse Withstand Characteristics

Charging and discharging a 2000pF Capacitor for 100 Cycles

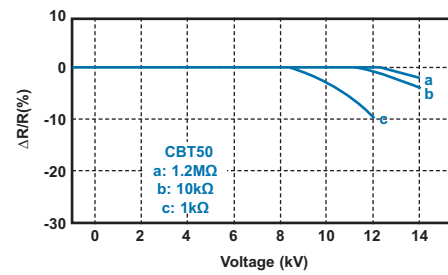
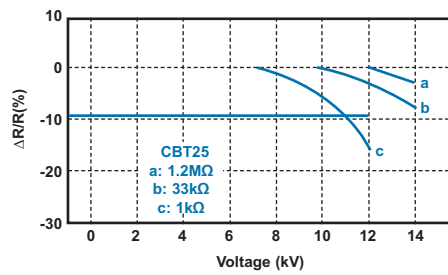

#### Resistance to Pulse Circuit

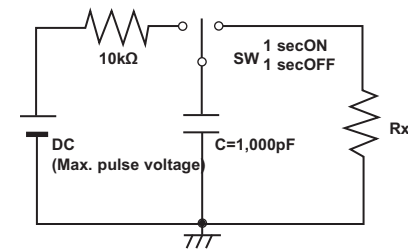

#### Resistance to Pulse Graphs - CCR1

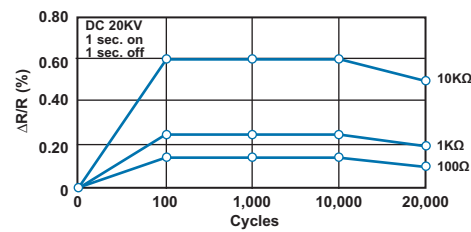

#### CCR2

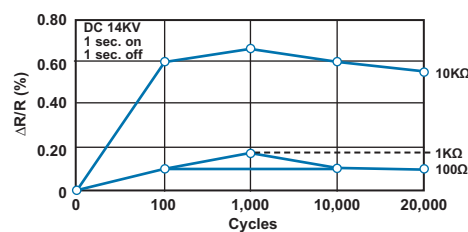

#### Dimensions

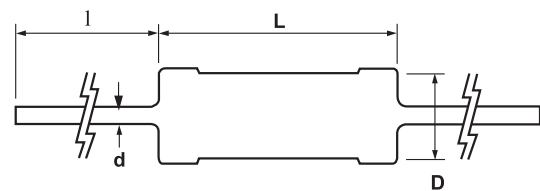

Style	L	D	d (nom)	l
CBT25	6.3 ± 0.7	2.4 ± 0.1	0.6	27 min.
CBT50	9.5 ± 0.8	3.6 ± 0.2	0.7	25 min.
CCR1/2	9.0 ± 1.0	3.5 ± 0.5	0.7	30 ± 3
CCR1	16.5 ± 1.0	5.5 ± 1.0	0.8	38 ± 3
CCR2	19.0 ± 1.0	7.0 ± 1.0	0.8	38 ± 3



## Product Portfolio for the Railway Sector

### Engineering Notes





## Product Portfolio for the Railway Sector

### Technology Terminology

#### Wire-wound

Traditional design, consisting of resistance wire wrapped around a ceramic core. Robust, cheap, and with a relatively high element mass, wire-wound elements provide excellent value due to their ability for withstanding high currents and absorption of large energy pulses. These resistors are available in a variety of sizes and are suited to applications where high short term overload capacity or very high power ratings are required.

**Suitable Applications:**

- Load test simulation
- Inrush limiting
- Crowbar
- Pre-charge
- Capacitor discharge

**Preferred Product Types:**

C • CFH • CJB • CJS • ER • ES • HS/THS  
LOAD BANK • R5000 • SBC • SQ • TT/TE • YP

#### Thick Film

Thick Film resistive elements consist of a metal and glass films printed onto a flat or tubular ceramic surface. Offering very low inductance values, these elements can be manufactured with a wide resistance range then laser trimmed to a high degree of accuracy. Benefits of this technology are the high thermal efficiencies allowing the resistor to have a higher power density compared with conventional wire-wound elements.

**Suitable Applications:**

- Balancing resistors
- Snubbing

**Preferred Product Types:**

BDS • HB • HH • HJ • HVR • MPC • MPT • RGP

#### Thin Film

A sputtered film of metal alloy deposited onto a ceramic surface. Commonly used in the manufacturing of precision resistors. Suited to high specification or technically demanding circuits whilst offering excellent thermal efficiency.

**Suitable Applications:**

- Inrush limiting
- Snubbing

**Preferred Product Types:**

MPR • RGP • RR • ROX

#### Foil

The element is formed by etching or punching a metal alloy into a serpentine shape which is then enclosed into a resistor package. This technology has a high element mass enabling it to withstand high energy pulses whilst offering good thermal efficiency and low inductance. Foil elements offer a robust solution but are limited in resistance value.

**Suitable Applications:**

- Inrush limiting
- Snubbing

**Preferred Product Types:**

BDF • R5000

#### Carbon Composition / Ceramic Composition

Consisting of either a bulk carbon or ceramic core, this technology is used when protection is required from high energy pulses.

**Suitable Applications:**

- Inrush limiting
- Protection

**Preferred Product Types:**

CBT • CCR



## Product Portfolio for the Railway Sector

### Application Terminology

#### Pre-Charge Resistor

This is used on system start up to charge the DC coupling capacitor. The resistor limits the inrush current during charging of the DC coupling capacitor. This capacitor sits across the DC voltage source to keep the line voltage constant when the input voltage drops low. The resistor must be able to absorb high energy from a single pulse, over a short time.

- **Key Feature:** Short-term overload capability

#### Capacitor Discharge Resistor

The resistor is fitted across the capacitor terminals to provide a safety function. When the voltage to the capacitor is removed, the resistor discharges any residual voltage in the capacitor making it safe to touch. The resistor must handle continuous power as it dissipates power continuously when the capacitor is connected to a voltage source.

- **Key Feature:** Continuous power dissipation

#### Inrush Limiting Resistor

Similar to precharge resistor, but offers protection to the rectifier section of circuit.

- **Key Feature:** Short-term overload capability

#### Crowbar Resistor

The resistor is used to drop the voltage to earth safely, generating a zero voltage in the circuit when a fault has been detected.

- **Key Feature:** Ability to absorb large short-term energy and voltage overloads, with a high insulation resistance

#### Balancing Resistor

The resistor is used to balance the voltage across critical components (such as IGBTs) when they are connected in series. This is to ensure that each component has equal voltage stress during operation.

- **Key Feature:** Tight tolerance, low power and high ohmic value

#### Current Sense Resistor

A low ohmic resistor creates a small voltage drop in the circuit. As the current in the circuit changes the voltage drop will vary. The change in voltage drop is used to measure the current to or from the circuit. This current can be monitored allowing an action in the control software.

- **Key Feature:** Low ohmic value, high accuracy

#### Snubber Resistor

The resistor is used to absorb transient high voltage spikes produced by switching a solid state switch (like relays, IGBTs, GTOs, etc.). It is connected in series with a capacitor across the switch. These switching operations can be very high frequency therefore the resistor must have a low inductance, so that the transient spike is not transferred back into the switch.

- **Key Feature:** Dissipation of repetitive energy pulses, low inductance

#### Filter Resistor

This resistor makes up a RC network which is used to reduce the noise on power lines. The resistor is fitted inline with a capacitor with one side connected to earth enabling it bleed overvoltage to ground. These resistors must be able to handle continuous power as they are in circuit constantly as the frequency of noise is high enough to be considered constant.

- **Key Feature:** Continuous power dissipation

#### Note: Partial Discharge

A resistor with low partial discharge is a requirement of many of the applications above. Partial discharge is a form of high voltage test that can be used to measure the life of the component. It measures the amount and size of voids in the insulation and therefore the quality of it.



## Product Portfolio for the Railway Sector

### Engineering Notes





## Product Portfolio for the Railway Sector

### Engineering Notes

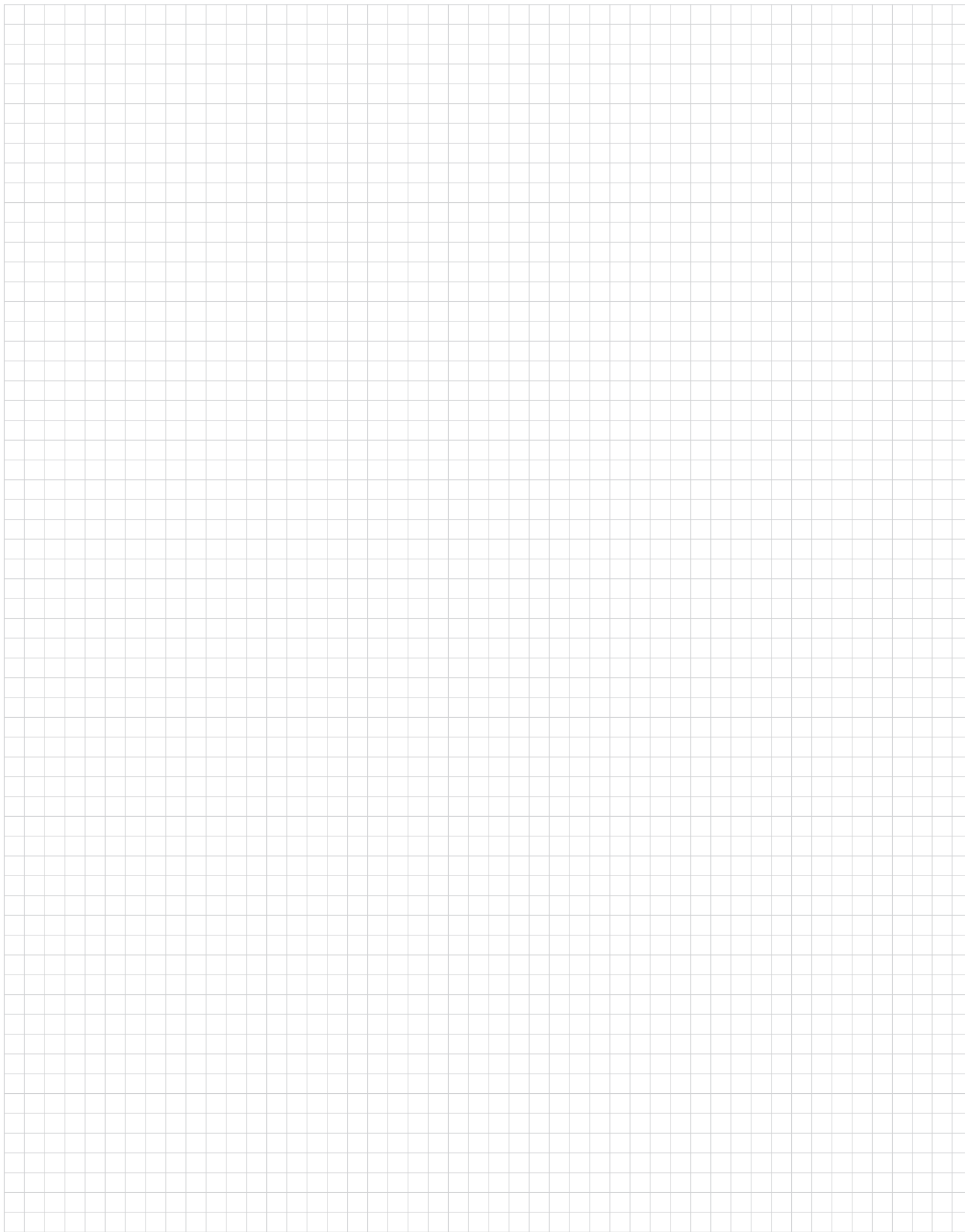

**FOR MORE INFORMATION**

[te.com/passives](http://te.com/passives)  
[te.com/railway](http://te.com/railway)

For email, phone or live chat, go to: [te.com/help](http://te.com/help)

**TE Connectivity Customer Support:**

Austria:	+43 1 90560 1228
Baltic Regions:	+46 8 50 72 50 20
Benelux:	+31 73 6246 999
Canada:	+1 905 475 6222
Mexico:	+52 55 1106 0800
China:	+86 400 820 6015
France:	+33 1 34 20 86 86
Germany:	+49 6251 133 1999
Italy:	+39 011 4012 632
Nordic:	+358 9 5123 4218
Latin & South America:	+54 11 4733 2200
Spain & Portugal:	+34 93 291 0366
Switzerland:	+41 71 447 04 47
United Kingdom:	+44 800 267 666
United States:	+1 800 522 6752

Part numbers in this brochure are RoHS Compliant\*, unless marked otherwise.  
\*as defined [te.com/leadfree](http://te.com/leadfree)

**TE Connectivity**

Berwyn, PA

[te.com](http://te.com)

© 2011 Tyco Electronics Corporation. All Rights Reserved.  
4-1773460-6 CIS BI 03/2011

FASTON, TE Connectivity and TE connectivity (logo) are trademarks of the TE Connectivity Ltd family of companies.  
Other logos, product and Company names mentioned herein may be trademarks of their respective owners.

While TE has made every reasonable effort to ensure the accuracy of the information in this catalog, TE does not guarantee that it is error-free, nor does TE make any other representation, warranty or guarantee that the information is accurate, correct, reliable or current. TE reserves the right to make any adjustments to the information contained herein at any time without notice. TE expressly disclaims all implied warranties regarding the information contained herein, including, but not limited to, any implied warranties of merchantability or fitness for a particular purpose. The dimensions in this catalog are for reference purposes only and are subject to change without notice. Specifications are subject to change without notice. Consult TE for the latest dimensions and design specifications.





## X-ON Electronics

Largest Supplier of Electrical and Electronic Components

*Click to view similar products for [Wirewound Resistors - Through Hole](#) category:*

*Click to view products by [TE Connectivity](#) manufacturer:*

Other Similar products are found below :

[75822-2K4](#) [90J56R](#) [AC03000001208JAC00](#) [EP3WS47RJ](#) [C1010KJL](#) [C1015RJL](#) [C3A10KJT](#) [27J1K0](#) [ES3W47RJ](#) [AC04000001500JAC00](#)  
[AC10000002208JAB00](#) [AC10000004708JAB00](#) [SQMW5R39J](#) [SQPW5R22J](#) [SQPW5R33J](#) [1879927-3](#) [FCB2100RJ](#) [T505](#) [FSQ5WR47J](#)  
[FW10A33R0JA](#) [CPCC03R5000JB31](#) [CPCC0510R00JE32](#) [CPCC051R000JB31](#) [CPCP10500R0JE32](#) [CPW05700R0JE143](#)  
[CPW152K500JE313](#) [C1010RJL](#) [C10R47JL](#) [C141K0JL](#) [C144R7JL](#) [ES05W100RJ](#) [SQMW1047RJ](#) [SQMW210RJ](#) [CPCC03R2000JB31](#)  
[CPCC0515R00JE01](#) [CPW055R000JB143](#) [CPW103K300JE143](#) [CPW202R000JB14](#) [ULW5-39R0JT075](#) [W31-R47JA1](#) [ULW5-68RJT075](#)  
[SQBW401K0JFASTON](#) [SPH1001JLF](#) [65888-3R3](#) [CPCC10R5100JE66](#) [SQP500JB-400R](#) [SQBW403R3JFASTON](#) [280-PRM7-4.7-RC](#)  
[CW02B9R100JE73](#) [CPCP05R1000JE32](#)