

LOC	DIST	REVISIONS					
		P	LTN	DESCRIPTION	DATE	DWN	APVD
ES	00	E9		REVISED 2-2 BY CUSTOMER	26FEB2015	CZ	SZ

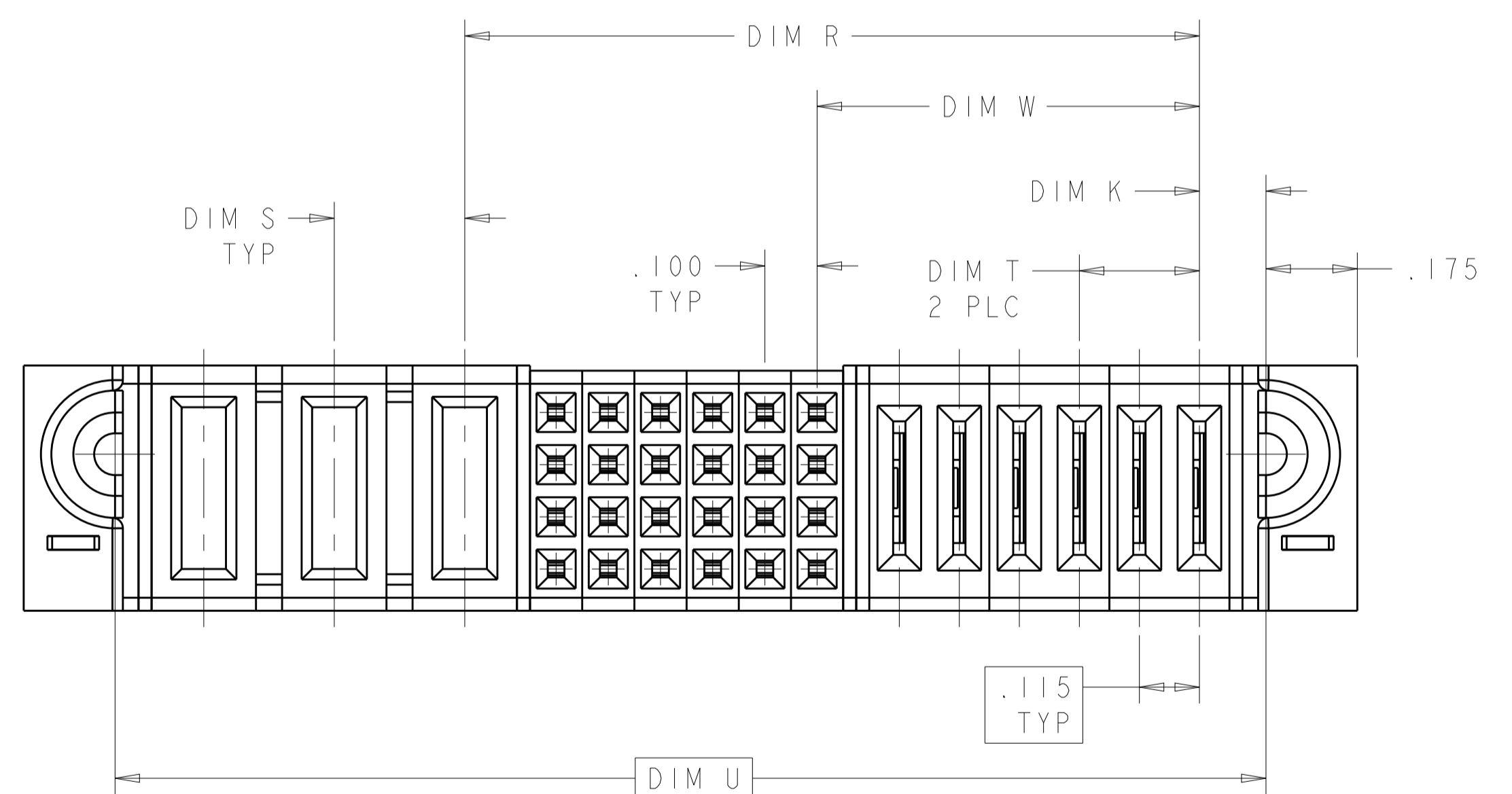

- 1 "AMP", TRADEMARK, PART NUMBER AND DATE CODE TO BE MARKED IN AREA SHOWN
- 2 MATERIAL: HOUSING - GLASS FILLED HIGH TEMP THERMO PLASTIC, UL94 V-0, BLACK
SIGNAL CONTACT - HIGH CONDUCTIVITY COPPER ALLOY
POWER CONTACT - HIGH CONDUCTIVITY COPPER ALLOY
- 3 CONTACT PLATING: NOBLE METAL PLATING ON CONTACT FUNCTIONAL AREA OF POWER AND SIGNAL CONTACTS
- 4 MECHANICAL CONNECTOR KEEP OUT ZONE
- 5 DATUM AND BASIC DIMENSIONS ESTABLISHED BY CUSTOMER
- 6 PCB - ALL HOLE DIAMETERS ARE FINISHED HOLE SIZES
- 7 PCB - .0453 ± .0010 DRILLED HOLES PLATED WITH .0003 MIN Sn OVER .001 TO .003 CU PLATING TO ACHIEVE A .040 ± .003 DIA HOLE
- 8 DIM W & DIM R ARE APPLICABLE TO P+S+P CONFIGURATION.
- 9 FOR P/N 6450850-3, -11, THE VARIABLE DIMENSIONS PLEASE SEE SHEET 2.
- 10 VARIABLE DIMENSIONS SHOW ON TABLE OR PART VIEW

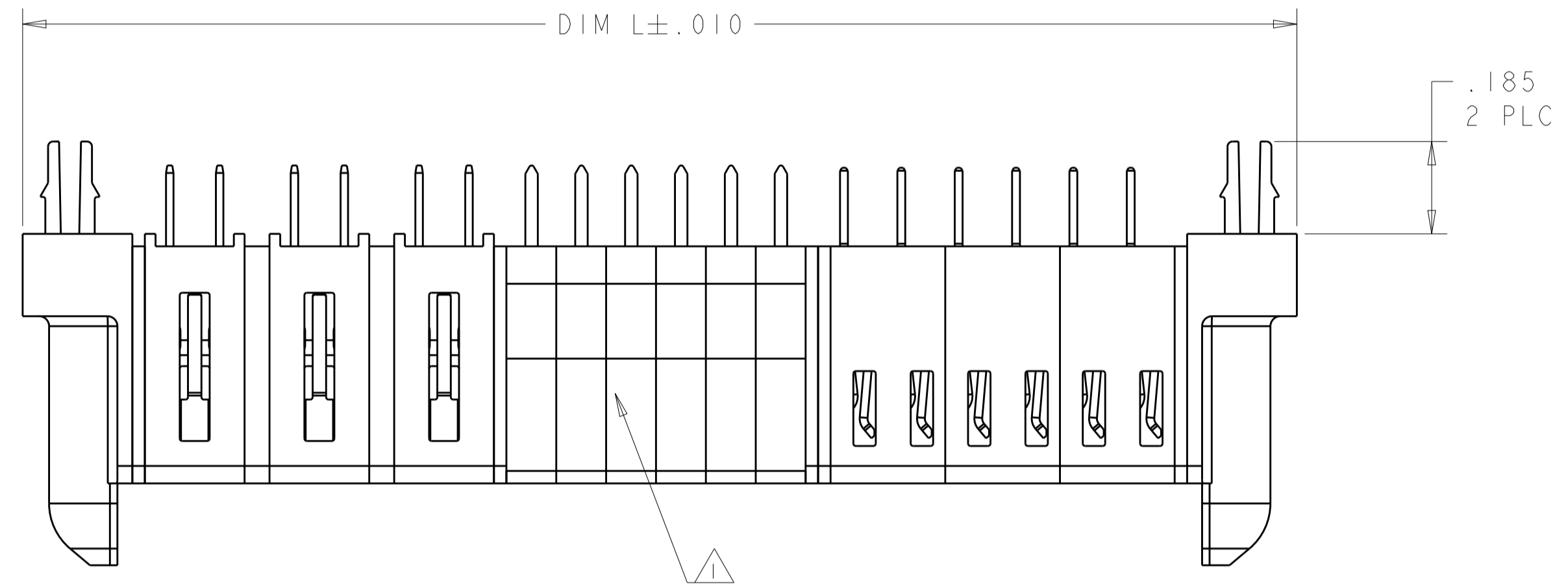
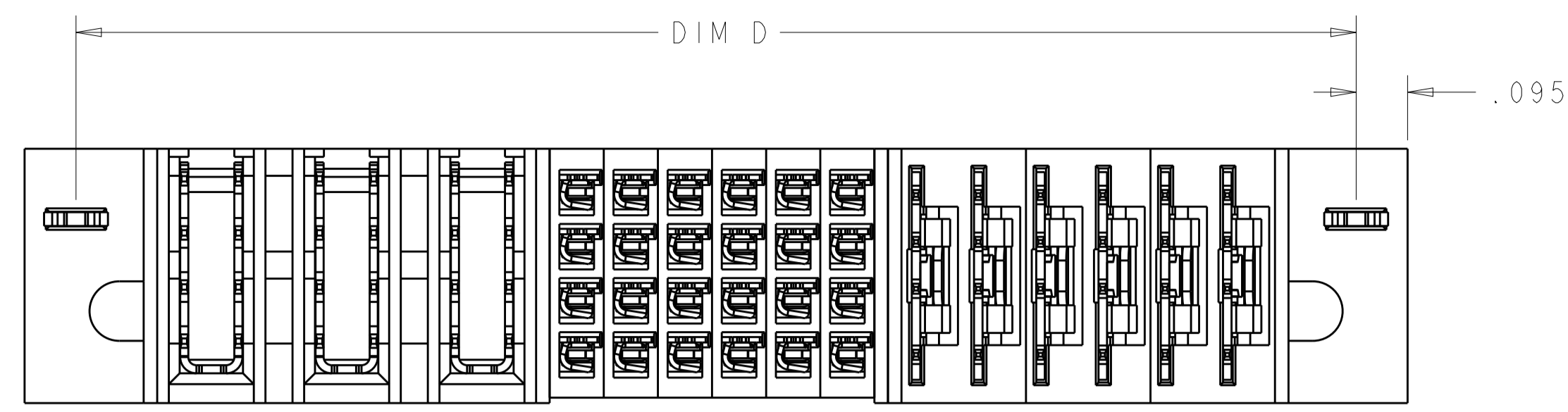
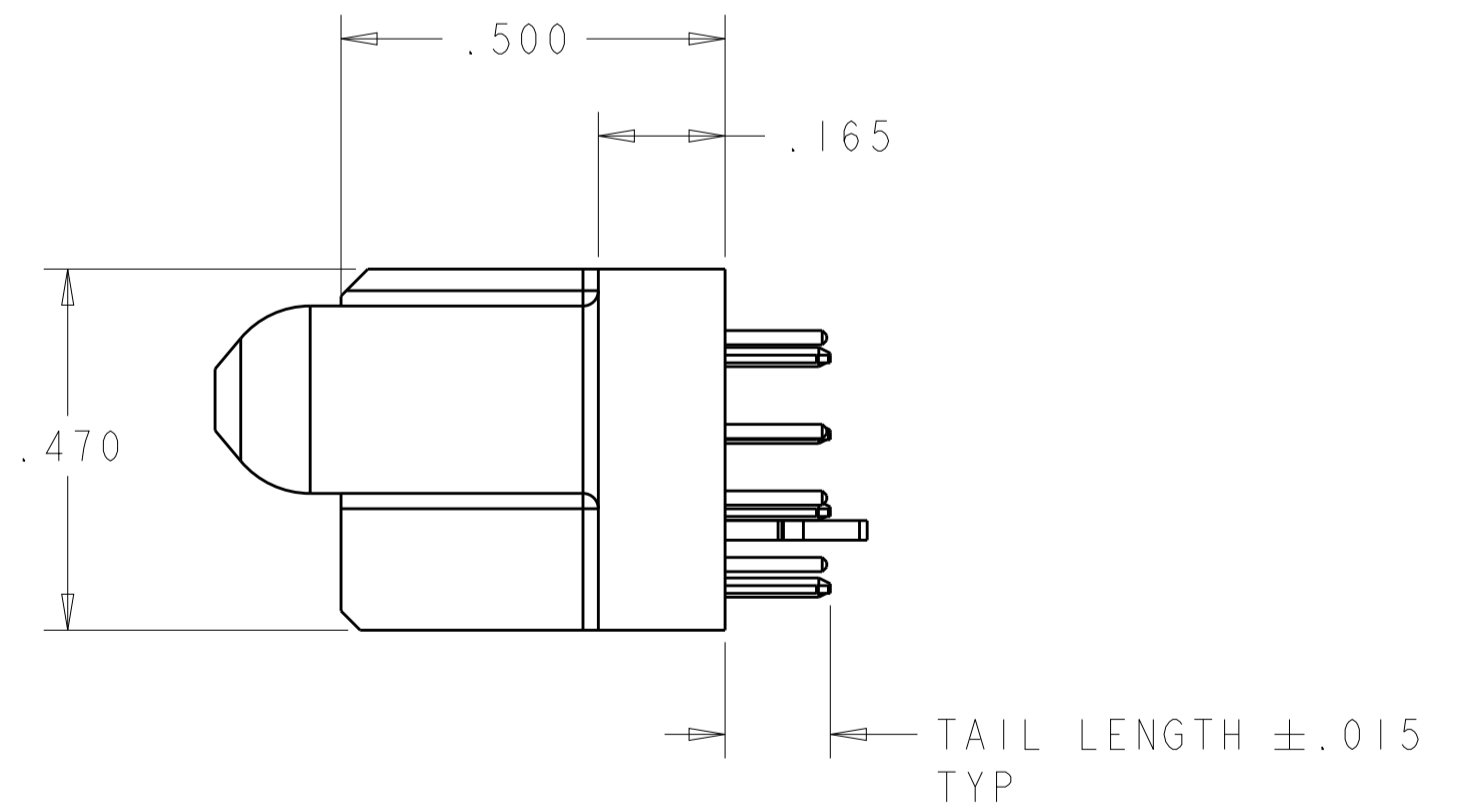

THIS DRAWING IS A CONTROLLED DOCUMENT.		DWN S. ZHAO CHK S. ZHAO	20SEP2007 20SEP2007	STE TE Connectivity
DIMENSIONS: INCHES		APVD S. YAO	NAME VERTICAL RECEPTACLE ASSEMBLY, WITH GUIDES MULTI-BEAM XLE	
TOLERANCES UNLESS OTHERWISE SPECIFIED:		PRODUCT SPEC		RESTRICTED TO
0 PLC ± 1 PLC ±.01 2 PLC ±.01 3 PLC ±.005 4 PLC ±.0020 ANGLES ±.7°		APPLICATION SPEC		
MATERIAL		SIZE CAGE CODE DRAWING NO		SCALE 4:1 SHEET 1 OF 8 REV E9
FINISH		A100779C=6450850		
CUSTOMER DRAWING		WEIGHT		

LOC		DIST		REVISIONS				
ES	00	P	LTN	DESCRIPTION	DATE	DMN	APVD	
-	-	-	-	SEE SHEET 1	-	-	-	

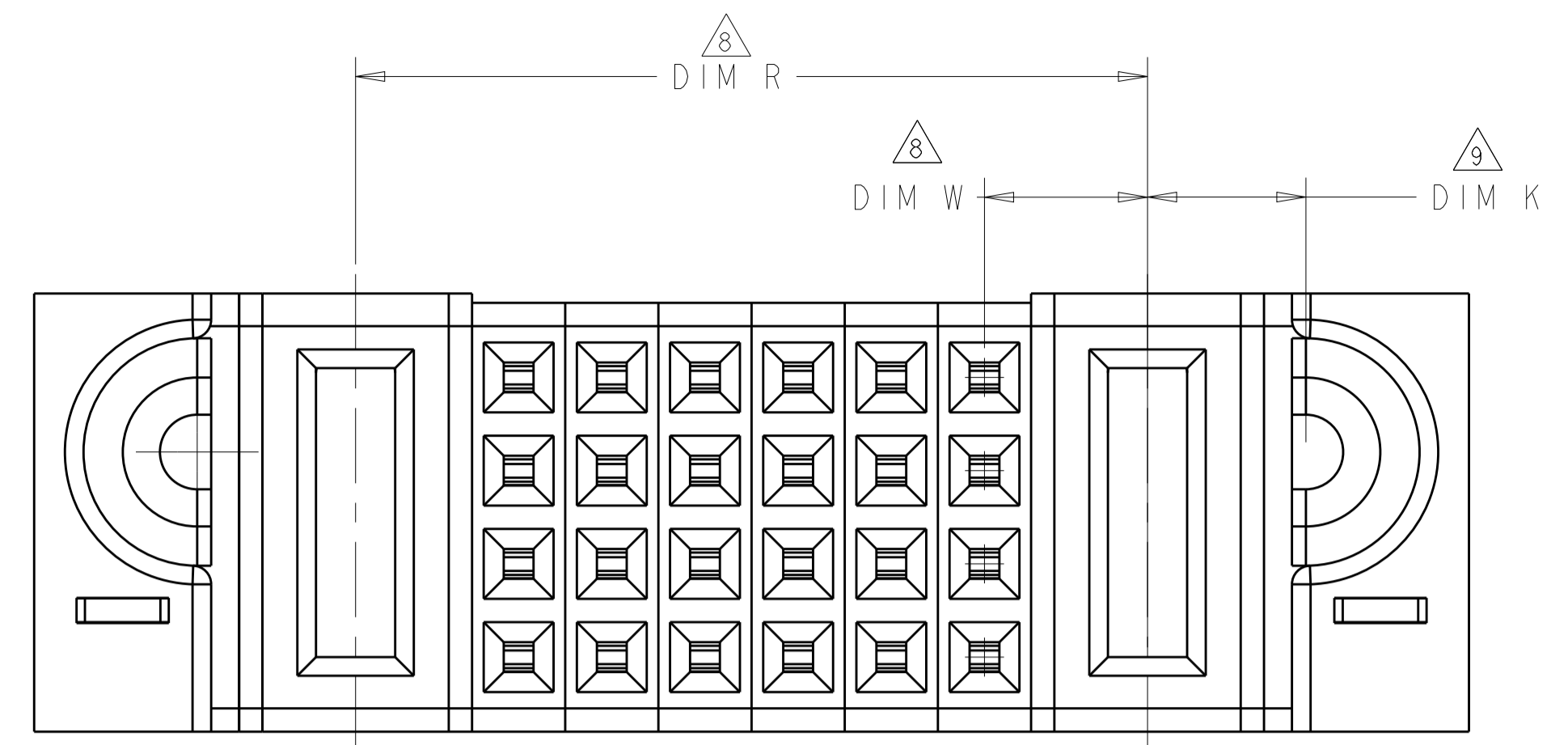

FOR P/N 6450850-3, -11, THE OTHER DIMENSIONS PLEASE SEE THE TABLE OF SHEET 1.

Δ	Δ	2.1275	1.1025	4.475	4.125	4.285	.1025	9LP + 36S + IP + 15LP	2-6450850-2
.300	.250	1.275	.800	2.490	2.140	2.300	.195	3ACP + 16S + 3P	2-6450850-1
.230	.230	1.090	.7825	1.990	1.640	1.800	.1025	3LP + 12S + 4LP	2-6450850-0
.250	.250	1.150	.675	2.340	1.990	2.150	.170	3P + 16S + 3P	1-6450850-9
Δ	Δ	Δ	Δ	3.270	2.920	3.080	.170	5HDP + 24S + IP + 7LP	1-6450850-8
-	-	.500	.200	1.140	.790	.950	.145	IP + 8S + IP	1-6450850-7
.300	.250	1.250	.775	2.940	2.590	2.750	.170	3ACP + 16S + 5P	1-6450850-6
.200	.200	.800	.350	1.840	1.490	1.650	.145	2P + 16S + 3P	1-6450850-4
.250	.250	1.300	.925	2.740	2.390	2.550	.170	4P + 12S + 4P	1-6450850-3
-	-	.850	.175	1.540	1.190	1.350	.170 Δ	IP + 24S + IP	1-6450850-1
-	-	.850	.175	1.540	1.190	1.350	.170 Δ	IP + 24S + IP	6450850-3
.230	.250	1.4075	.7325	2.555	2.205	2.365	.1275	6LP + 24S + 3P	6450850-2
DIM T	DIM S	DIM R Δ	DIM W Δ	DIM L	DIM U	DIM D	DIM K	DESCRIPTION	PART NUMBER

THIS DRAWING IS A CONTROLLED DOCUMENT. DMN S. ZHAO 20SEP2007
 CHK S. ZHAO 20SEP2007

DIMENSIONS: INCHES TOLERANCES UNLESS OTHERWISE SPECIFIED:
 0 PLC ±.01
 1 PLC ±.01
 2 PLC ±.01
 3 PLC ±.005
 4 PLC ±.0020
 ANGLES ±.7°
 FINISH

MATERIAL: -

APVD S. YAO

PRODUCT SPEC 108-1973
 APPLICATION SPEC 114-13038

WEIGHT -

CUSTOMER DRAWING

STE TE Connectivity

NAME VERTICAL RECEPTACLE ASSEMBLY, WITH GUIDES MULTI-BEAM XLE

SIZE CAGE CODE DRAWING NO RESTRICTED TO
 A100779C=6450850

SCALE 4:1 SHEET 2 OF 8 REV E9

LOC	DIST	REV	DATE	BY	APPD
ES	00				

REVISIONS		DATE	BY	APPD
-	SEE SHEET 1	-	-	-

PART NUMBER	ROWS	POWER				SIGNAL			POWER			
		P8	P7	P6	P5	3	2	1	P4	P3	P2	P1
I-6450850-3	D					E	E	E				
	C					E	E	E				
	B	VM	VM	VM	VM	E	E	E	VM	VM	VM	VM
	A	HD				E	E	E				HD

4P + 12S + 4P

PART NUMBER	ROWS	POWER			SIGNAL				POWER	
		P5	P4	P3	4	3	2	1	P2	P1
I-6450850-4	D				E	E	E	E		
	C				E	E	E	E		
	B	VM	VM	VM	E	E	E	E	VM	VM
	A	HD			E	E	E	E		HD

2HDP + 16S + 3HDP

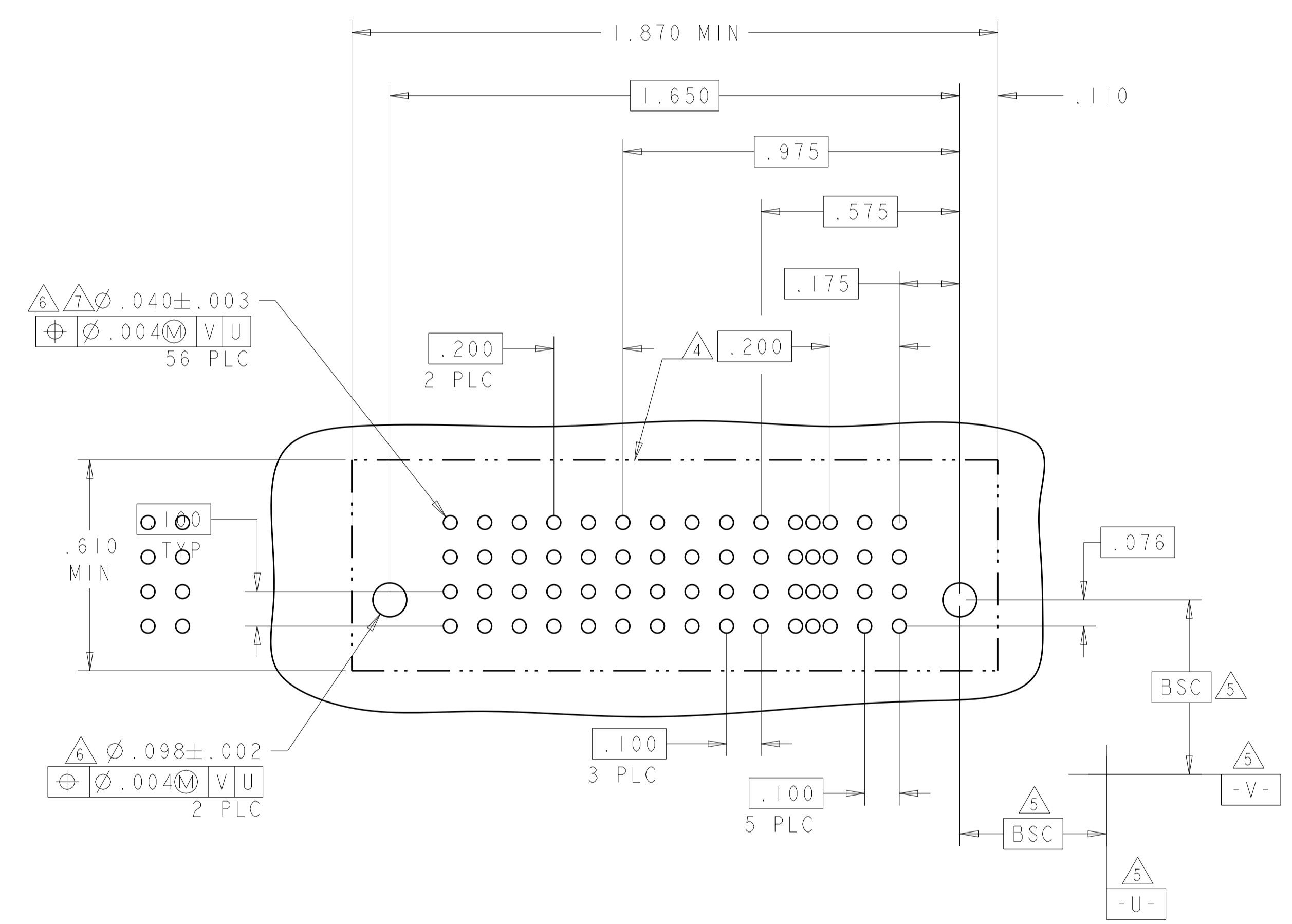
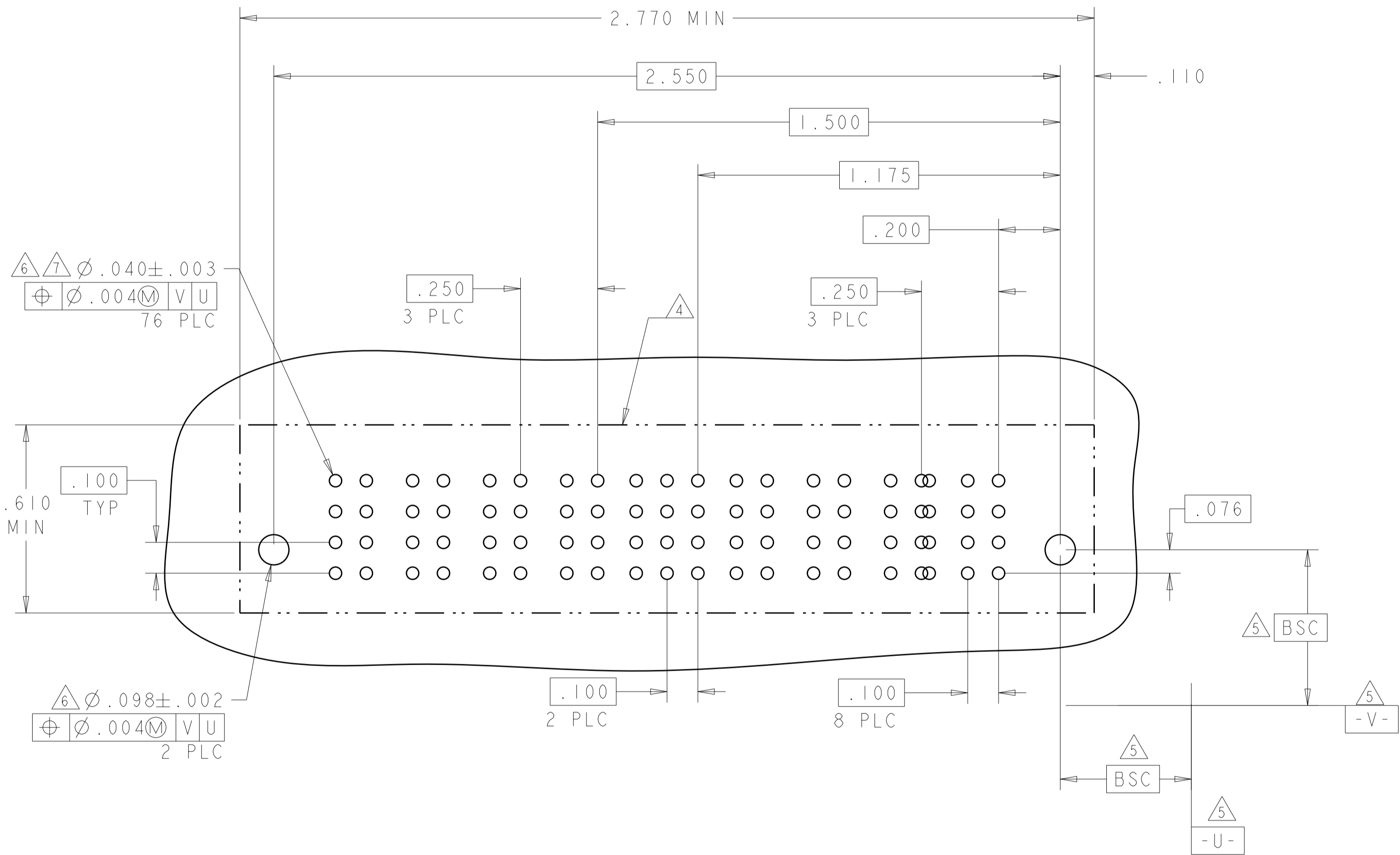

THIS DRAWING IS A CONTROLLED DOCUMENT.		OWN: S. ZHAO 20SEP2007	TE Connectivity
DIMENSIONS: INCHES		CHK: S. ZHAO 20SEP2007	
TOLERANCES UNLESS OTHERWISE SPECIFIED:		APVD: S. YAO	NAME: VERTICAL RECEPTACLE ASSEMBLY, WITH GUIDES MULTI-BEAM XLE
0 PLC ± .01	1 PLC ± .01	PRODUCT SPEC 108-1973	SIZE: CAGE CODE DRAWING NO. RESTRICTED TO
2 PLC ± .01	3 PLC ± .005	APPLICATION SPEC 114-13038	A100779C=6450850
4 PLC ± .0020	ANGLES ± .2°	WEIGHT	SCALE 4:1 SHEET 4 OF 8 REV E9
MATERIAL	FINISH	CUSTOMER DRAWING	

LOC	DIST	REVISIONS			
P	LTN	DESCRIPTION	DATE	DMN	APVD
ES	00	SEE SHEET 1			

PART NUMBER	ROWS	POWER					SIGNAL				POWER		
		P8	P7	P6	P5	P4	4	3	2	1	P3	P2	P1
1-6450850-6	D						E	E	E	E			
	C	VA	VM	VM	VM	VA	E	E	E	E	VM	VM	VA
	B						E	E	E	E			
	A	HD					E	E	E	E			HD

3ACP + 16S + 5P

PART NUMBER	ROWS	POWER		SIGNAL		POWER	
		P2	2	1	P1		
1-6450850-7	D						
	C	VM		E	E		
	B			E	E		
	A			E	E		

IP + 8S + IP

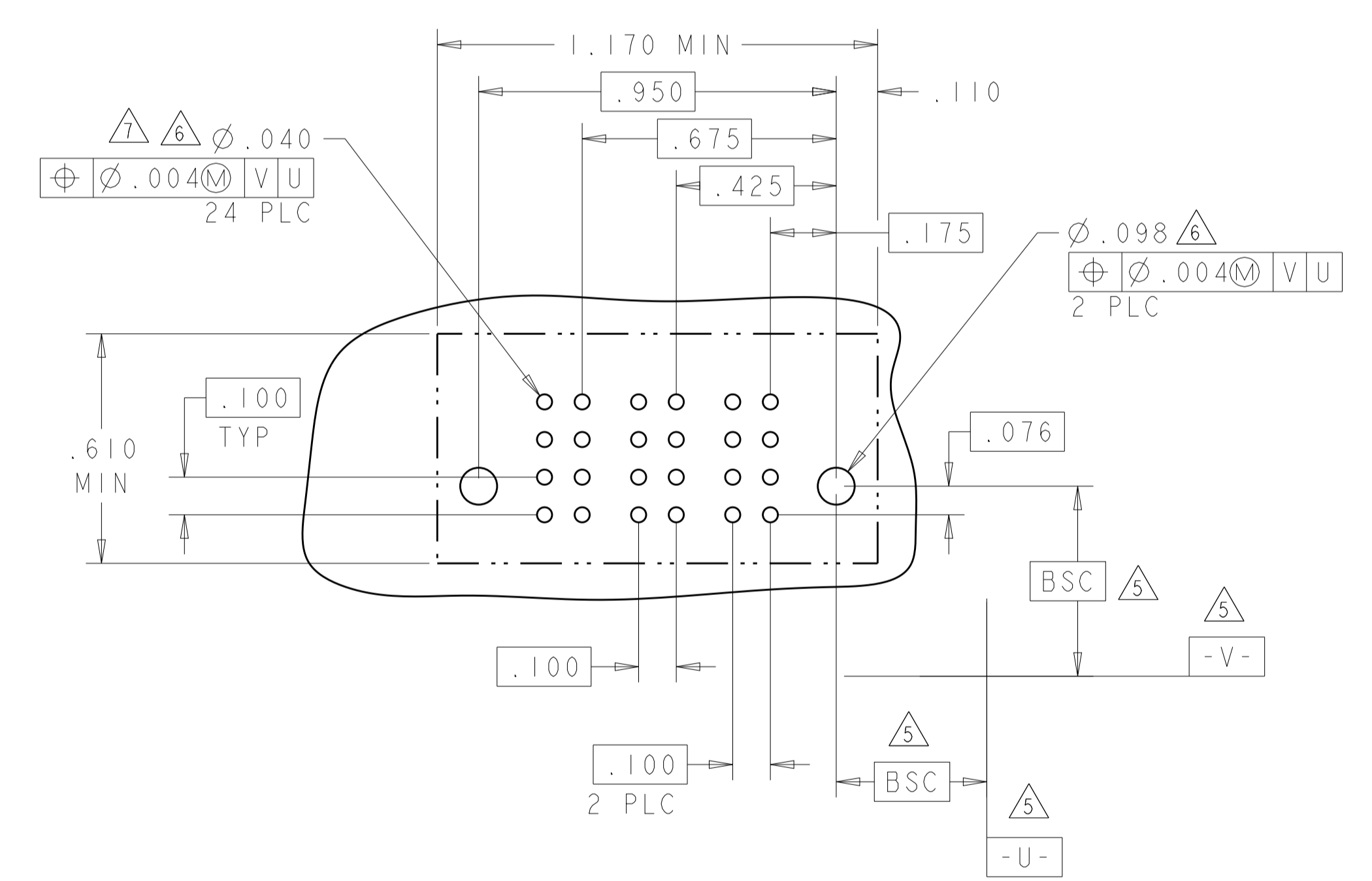
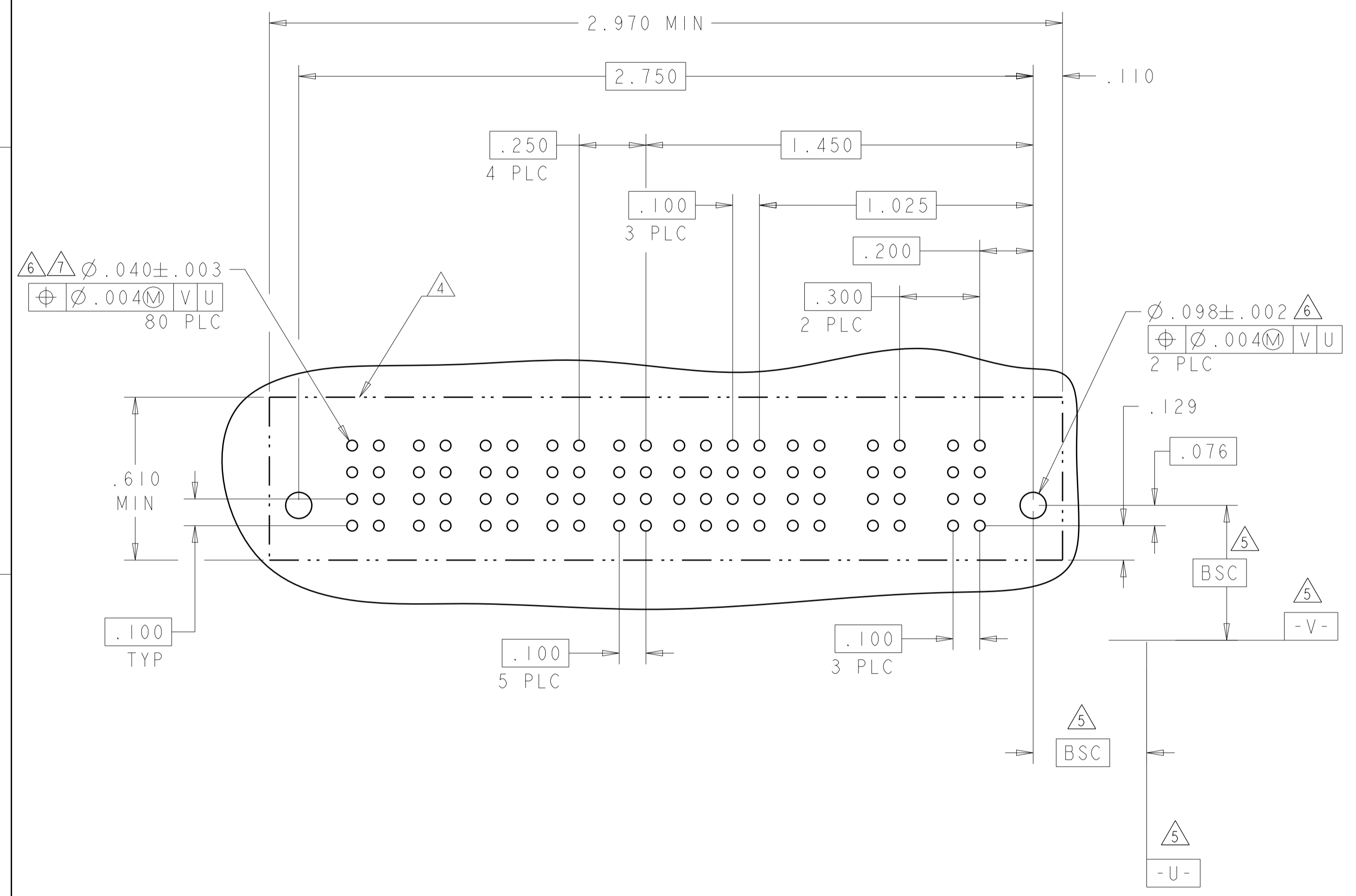

THIS DRAWING IS A CONTROLLED DOCUMENT.		DMN S. ZHAO 20SEP2007	TE Connectivity
DIMENSIONS: INCHES		CHK S. ZHAO 20SEP2007	
TOLERANCES UNLESS OTHERWISE SPECIFIED:		APVD S. YAO	NAME VERTICAL RECEPTACLE ASSEMBLY, WITH GUIDES MULTI-BEAM XLE
0 PLC ±	1 PLC ±.01	PRODUCT SPEC 108-1973	SIZE CAGE CODE DRAWING NO RESTRICTED TO
2 PLC ±.01	3 PLC ±.005	APPLICATION SPEC 114-13038	A100779C=6450850
4 PLC ±.0020	ANGLES ±.020	WEIGHT	SCALE 4:1 SHEET 5 OF 8 REV E9
MATERIAL	FINISH	CUSTOMER DRAWING	

LOC	DIST	REVISIONS			
P	LTN	DESCRIPTION	DATE	DMN	APVD
ES	00	SEE SHEET 1			

PART NUMBER	ROWS	LOW POWER				SIGNAL			LOW POWER		
		LP7	LP6	LP5	LP4	3	2	1	LP3	LP2	LP1
2-6450850-0	D					E	E	E			
	C					E	E	E			
	B					E	E	E			
	A	LM	LM	LM	LM	E	E	E	LM	LM	LM
		HD									HD
3LP + 12S + 4LP											

PART NUMBER	ROWS	POWER			SIGNAL				POWER		
		P6	P5	P4	4	3	2	1	P3	P2	P1
2-6450850-1	D				E	E	E	E			
	C				E	E	E	E			
	B				E	E	E	E			
	A	VA	VM	VA	E	E	E	E	VM	VM	VA
		HD									HD
3ACP + 16S + 3P											

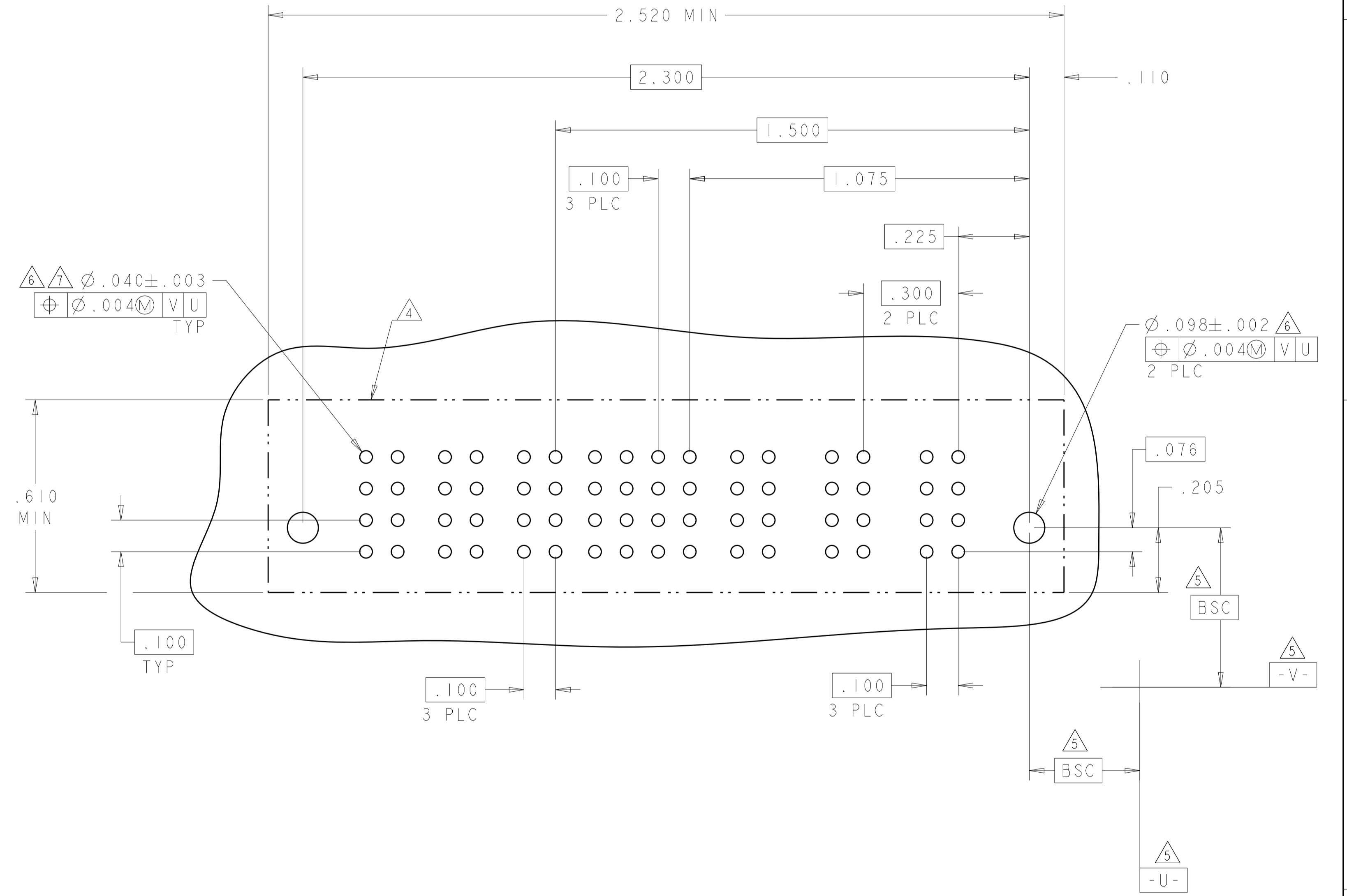
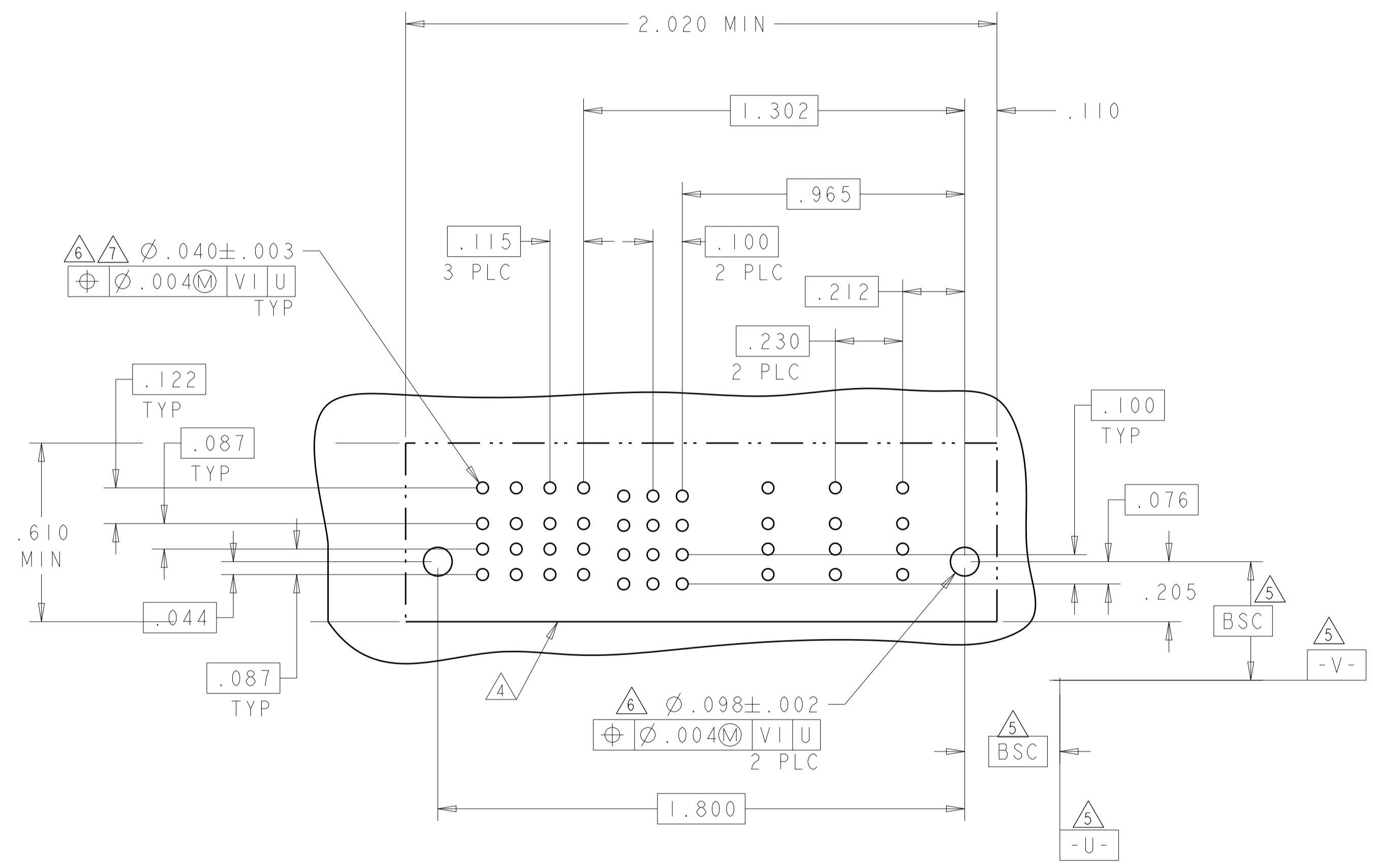

THIS DRAWING IS A CONTROLLED DOCUMENT.		DMN S. ZHAO 20SEP2007	TE Connectivity
DIMENSIONS: INCHES		CHK S. ZHAO 20SEP2007	
TOLERANCES UNLESS OTHERWISE SPECIFIED:		APVD S. YAO	NAME VERTICAL RECEPTACLE ASSEMBLY, WITH GUIDES MULTI-BEAM XLE
0 PLC ± 1 PLC ±.01 2 PLC ±.01 3 PLC ±.005 4 PLC ±.0020 ANGLES ±.2° FINISH		PRODUCT SPEC 108-1973	SIZE CAGE CODE DRAWING NO. RESTRICTED TO
MATERIAL		APPLICATION SPEC 114-13038	A100779C=6450850
		WEIGHT	SCALE 4:1 SHEET 7 OF 8 REV E9
		CUSTOMER DRAWING	

X-ON Electronics

Largest Supplier of Electrical and Electronic Components

Click to view similar products for [Power to the Board](#) category:

Click to view products by [TE Connectivity](#) manufacturer:

Other Similar products are found below :

[10131318-08512GRLF](#) [6450171-4](#) [6450552-7](#) [6600323-8](#) [6643429-1](#) [6646040-2](#) [6651939-1](#) [6766604-1](#) [120959-1](#) [1393557-2](#) [1393532-2](#)
[1393532-3](#) [1393532-4](#) [1393557-1](#) [1600812-5](#) [1-6450861-2](#) [1645595-1](#) [1743490-1](#) [1744132-7](#) [1761122-1](#) [1766169-1](#) [1766250-1](#) [18362](#)
[1892109-1](#) [1-967627-6](#) [2226808-1](#) [2-6450860-5](#) [2-6450860-6](#) [2-6450870-0](#) [93003-0502](#) [953552-1](#) [1-6450161-4](#) [1-6450850-6](#) [1645526-2](#) [1-](#)
[6600130-0](#) [1743419-1](#) [1766150-1](#) [2005243-2](#) [211110-1](#) [2-6600130-2](#) [TE34-12-16P-F0](#) [51700-10201602AALF](#) [5-6450830-6](#) [5646956-4](#)
[36662-0005](#) [40585-3000](#) [4-6450830-9](#) [4-6600333-3](#) [51142-0214](#) [10125416-4050LF](#)