

MINIMUM INSERTION LOSS IN DB
LINE TO GROUND IN 50 OHM CIRCUIT

MINIMUM INSERTION LOSS IN DB
LINE TO LINE IN 50 OHM CIRCUIT

CURRENT	FREQUENCY MHZ			CURRENT	FREQUENCY MHZ			STYLE	DIMENSION 'A'			DIMENSION B		
	0.15	0.5	1		3	5	10		30	0.15	0.5		1	3
H MODELS														
3 AMP	21	27	30	29	26	23	15	4	12	18	31	40	48	41
6 AMP	11	15	17	19	18	16	13	4	12	16	26	35	40	35
10 AMP	5	8	10	12	11	11	10	4	12	16	26	33	40	32
S MODELS														
3 AMP	21	27	33	40	44	50	32	4	12	15	30	48	50	45
6 AMP	12	17	23	32	36	44	30	4	12	15	22	42	55	45
10 AMP	5	10	13	23	27	35	27	4	12	15	22	42	55	45
* FOR PANEL THICKNESS OF 0.031" - 0.079" ONLY.														
USE 2.213 FOR PANEL THICKNESS OF 0.083" - 0.114"														
PSJ 1.06 1.12 1.06 45														
PSC 1.06 1.12 1.06 45														
PM 1.06 1.12 1.06 45														
PE 1.12 1.12 1.12 45														
PSL 1.12 1.12 1.12 45														
PS 1.06 1.12 1.06 45														

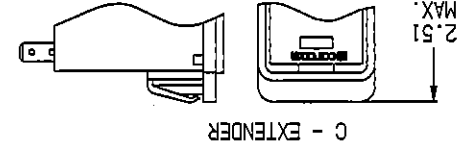

C - EXTENDER

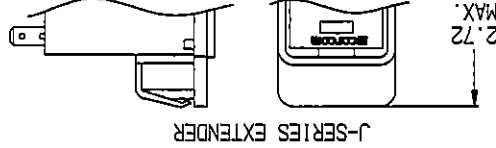

J-SERIES EXTENDER

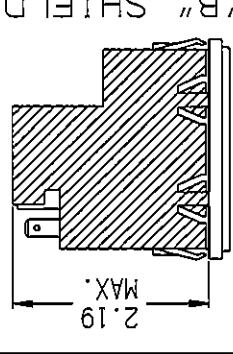
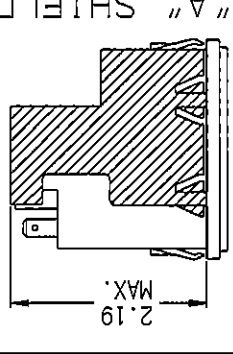
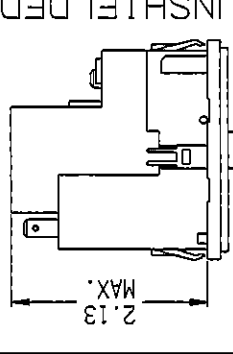
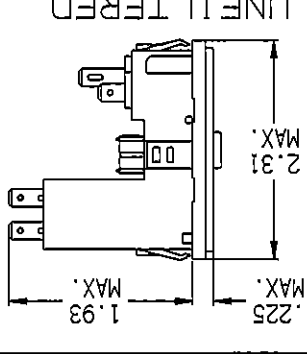
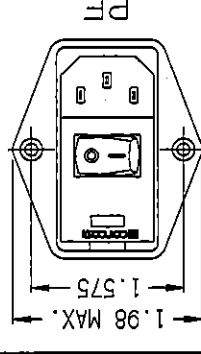
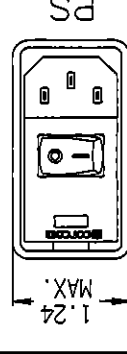
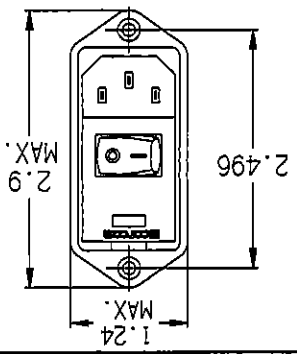

PM

PS

PE

UNFILTERED

UNSHIELDED

"A" SHIELD

"B" SHIELD

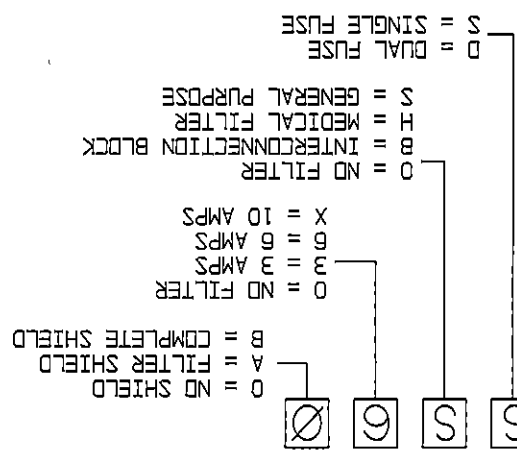
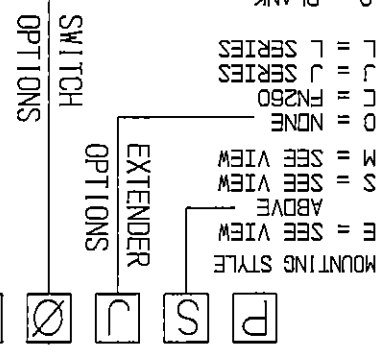

CONVERSION CLIP
FOR SINGLE FUSE
APPLICATIONS

Tyco Electronics
CUSTOMER DRAWING
P-SERIES

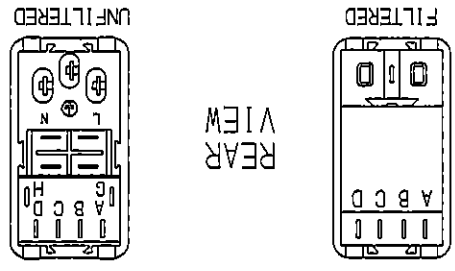

REAR
VIEW

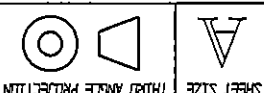

THIS INFORMATION IS CONFIDENTIAL AND PROPRIETARY TO TYCO ELECTRONICS CORPORATION AND ITS WORLDWIDE SUBSIDIARIES AND AFFILIATES. IT MAY NOT BE DISCLOSED TO ANYONE OTHER THAN TYCO ELECTRONICS PERSONNEL, WITHOUT WRITTEN AUTHORIZATION FROM TYCO ELECTRONICS CORPORATION, HARRISBURG, PENNSYLVANIA USA.

SCALE: NA
DATE: 2/4/97
DRAWING NUMBER: P-SERIES
REV: D

TYCO ELECTRONICS PART NO.

CUSTOMER DRAWING
P-SERIES

CORCOM PRODUCTS, 620 S. BUTTERNUT RD., MUNDLEIN, IL 60060



UL RECOGNIZED
CSA CERTIFIED
VDE APPROVED



THIS FILTER HAS BEEN FORMALLY RECOGNIZED, CERTIFIED OR APPROVED BY THE LISTED AGENCY. THEREFORE, ALL TEST/REQUIREMENTS SPECIFIED IN THE LATEST REVISION OF THE FOLLOWING AGENCY STANDARDS HAVE BEEN MET:

SAFETY ORGANIZATIONS

GENERAL NOTES:
CONVERSION CLIP PROVIDED ON FUSEHOLDER FOR SINGLE FUSE MODELS.
SWITCH: DOUBLE INSULATED RATED FOR 10,000 OPERATIONS AT FULL LOAD.
51 AMP INRUSH CAPABILITY.
TERMINALS: FOUR 0.187" x 0.032" QUICK CONNECT TABS
ONE SOLDER TERMINAL

SEE INDIVIDUAL CUSTOMER
DRAWINGS FOR OTHER (L AND Z)
P-SERIES VERSIONS.



S MODEL



H MODEL

RATED CURRENT, I_R:

3, 6 & 10 AMP
MODELS AVAILABLE

@ 250 VAC 50Hz:

S MODELS 0.50mA
H MODELS 51A

@ 120 VAC 60Hz:

H MODELS 27A
S MODELS 0.25mA

MAXIMUM LEAKAGE CURRENT, EACH LINE TO GROUND

NONFILTERED MODELS

RATED CURRENT, I_R:

10A @ 120 VAC
10A @ 250 VAC

FILTERED MODELS

HIPOT RATING (ONE MINUTE):
LINE TO GROUND: 1500 VAC
LINE TO LINE: 1450 VDC
OPERATING FREQUENCY: 50/60 Hz
RATED VOLTAGE: 120/250 VAC
OPERATING VOLTAGES: 115/230 VAC
SELECTABLE FUSEHOLDER ACCEPTS 1 OR 2 FUSES
1/4" x 1-1/4"
OR 5 x 20mm
OPERATING AMBIENT TEMP.: -10°C TO +40°C
STORAGE TEMPERATURE: -40°C TO +85°C
HUMIDITY: 21 DAYS, 40°C @95% RH.
CURRENT OVERLOAD TEST: 6 TIMES I_R FOR 8 SECONDS

SPECIFICATIONS

NOTE 1: JUMPERS ARE REQUIRED IF A FILTER OR INTERCONNECTION MODULE IS NOT USED.
NOTE 2: LOCATION OF OPTIONAL FILTER, JUMPERS ARE REQUIRED IF A FILTER OR INTERCONNECTION MODULE IS NOT USED.

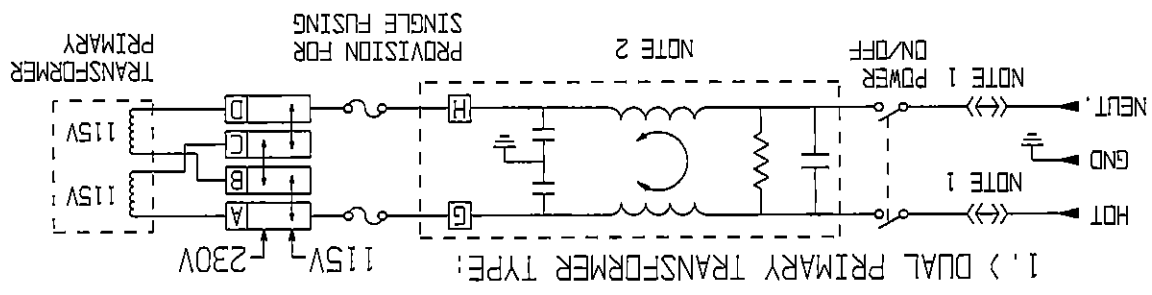
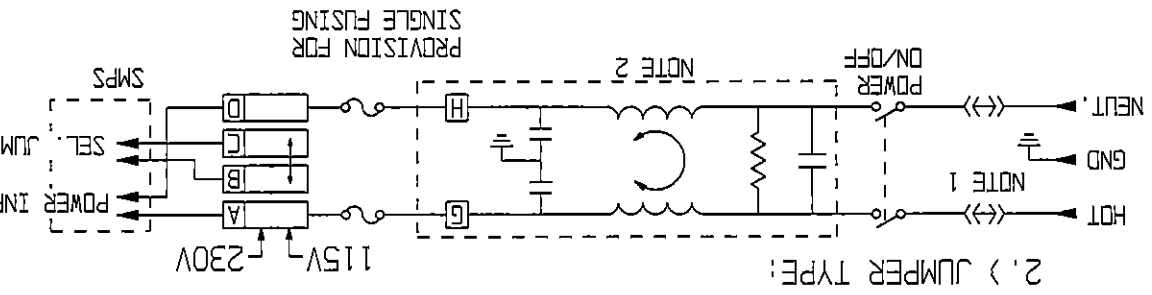

X-ON Electronics

Largest Supplier of Electrical and Electronic Components

Click to view similar products for [Modular Connectors / Ethernet Connectors](#) category:

Click to view products by [TE Connectivity](#) manufacturer:

Other Similar products are found below :

[RJE231881317T](#) [MP1010RX-1000](#) [MP44RX-1000](#) [GAX-3-66](#) [GAX-8-62](#) [93606-0253](#) [GD-A-44](#) [GDCX-PA-66-50](#) [GDCX-PN-64](#) [GDCX-PN-66](#) [GDCX-PN-66-50](#) [GDLX-A-66](#) [GDLX-A-88](#) [GDLX-N-66](#) [GDLX-S-88K](#) [GDTX-S-88-50](#) [GDX-PA-1010](#) [GLX-N-1010M-BLK](#) [GLX-N-44M](#) [GLX-S-88M-BLK](#) [GMX-N-1010](#) [GMX-S-1010](#) [GMX-S-66](#) [GMX-SMT2-N-1010](#) [GMX-SMT2-N-64-50](#) [GMX-SMT2-S6-88](#) [GMX-SMT4-N-88](#) [GPX-2-64](#) [GRT1-BT1-5](#) [GSGX-N-2-88](#) [GSX-NS2-88-3.05](#) [GSX-NS2-88-3.05-50](#) [GSX-NS-88-3.05-30](#) [GSX-NS-88-3.05-50](#) [GSX-NS-88-3.68](#) [1-1775629-2](#) [GWLX-S-88-GR](#) [GWLX-S9-88-YG](#) [1300500326](#) [1300500227](#) [1300530003](#) [1300570002](#) [1324640-4](#) [RJ11FTVC2G](#) [RJ11FTVC2N](#) [RJFTVX2SA1G](#) [132764-001](#) [1400000](#) [1413176](#) [1413235](#)