

© COPYRIGHT 2010 BY TYCO ELECTRONICS CORPORATION. ALL INTERNATIONAL RIGHTS RESERVED.

一般公差 GENERAL TOLERANCE	
30以下 100以下 OVER 30 NOT REACHING 100	±0.3
10以下 30以下 OVER 10 NOT REACHING 30	±0.25
NOT REACHING 10 角 ANGLE	±0.2 ±0°

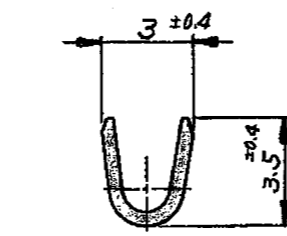

断面 'A-A'
(SECTION "A-A")

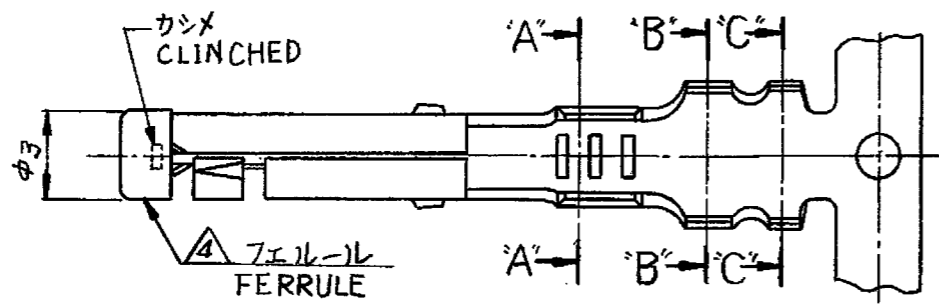
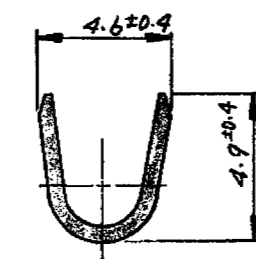

断面 'C-C'
(SECTION "C-C")

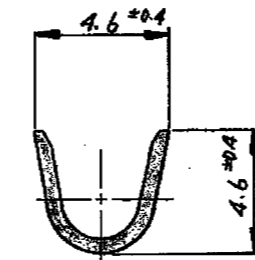
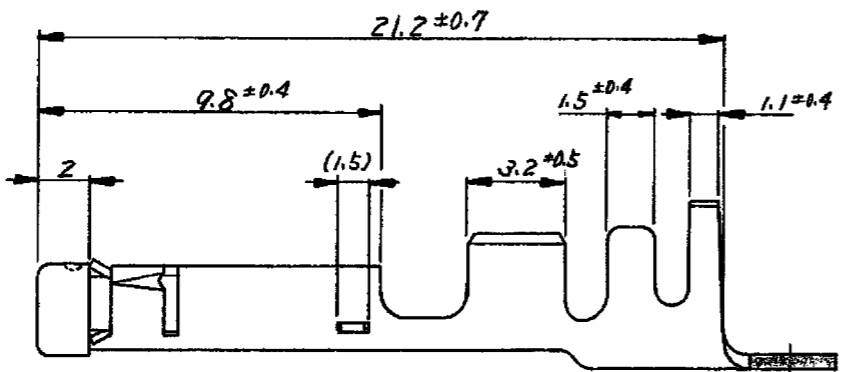
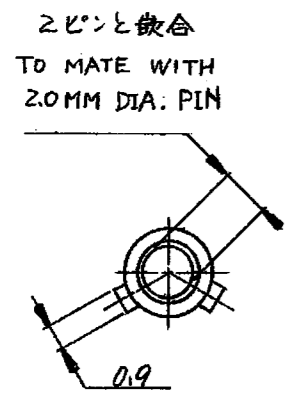

断面 'B-B'
(SECTION "B-B")

注:

- 嵌合相手型番 170279
 - 適用製品規格番号 108-5121
 - 適用端子圧着仕様書番号 114-5039
- △ フェルル材料: 黄銅

NOTES

- MATING COUNTERPART PART NUMBER 170279
 - APPLICABLE PRODUCT SPECIFICATION NUMBER 108-5121
 - APPLICABLE APPLICATION SPECIFICATION NUMBER 114-5039
- △ FERRULE MATERIAL: BRASS

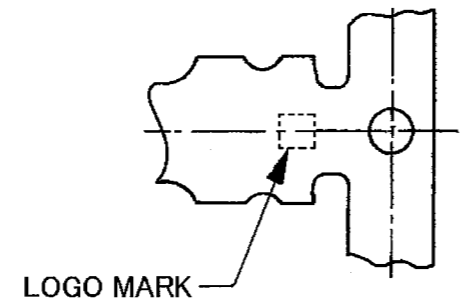

単位: 概 寸法 IN MM. DO NOT SCALE PRINT

LTR.	変更 (REVISION RECORD)	DR.	CHK.	DATE
C	EGR-10-018948	TS	MP	12/27/2010
B ₁	ECN J-12303	DMK	Y	3/19/08
B	ECN J80-5657	KA	JK	7/1/00
A ₁	ECN JB-5003	S.O	HN	1/30/00
A	変更	M.N	YS	9/8/00
0	作成	K.Y	JK	5/26/98

	逆巻リール (REVERSED REEL)	0.32	錫めき付黄銅 (PRETIN BRASS)	1-170280-1
170293-1	—	0.32	錫めき付黄銅 (PRETIN BRASS)	170280-1
パラ 端子型番 (LP PART No)	備考 (REMARKS)	板厚 (STOCK THICKNESS)	材料 (MATERIAL)	番号 (NUMBER)
	表参照 (SEE TABLE)	一般公差 (TOLERANCE) ± 4 (EXCEPT AS NOTED)	Tyco Electronics Corporation Kawasaki, Japan	
	適用配線範囲 (APPLICABLE WIRE RANGE) 0.5~2mm	DR. X. ymas 5/19/78	名称 (NAME) 2φピンリセプタクルランスレス	
	被覆外径 (INSULATION DIAMETER) 2.2~3.4mm	CHK. 5-21-78	2MM DIA PIN RECEPTACLE LANCELESS	
		DE. M. J. 5-21-78	SIZE B	LOC J
		APP. X. ymas 5/17/78	番号 (NO.) C-170280	
			尺度 (SCALE) 4:1	REV. C
			SHEET #	

X-ON Electronics

Largest Supplier of Electrical and Electronic Components

Click to view similar products for [Automotive Connectors](#) category:

Click to view products by [TE Connectivity](#) manufacturer:

Other Similar products are found below :

[003-018-000](#) [60403001](#) [60993906-B](#) [M902-2131](#) [M902-2161](#) [72.330.1035.1](#) [73.353.4028.0](#) [F119300-B](#) [F166900](#) [F258300-B](#) [F358300-B](#)
[F407400](#) [F444110](#) [F487000](#) [F509500B-B](#) [827153-1](#) [8N1515-32-24P](#) [9-1326729-8](#) [925474-1](#) [928905-1](#) [964562-4](#) [968782-1](#) [GT17SA-8DS-](#)
[HU](#) [98891-1012](#) [98947-1016](#) [12004147](#) [12004475-L](#) [12010290](#) [12010309-B](#) [12015454](#) [12020219-B](#) [12020308](#) [12041318-B](#) [12052225-L](#)
[12052466](#) [12059125](#) [12064869](#) [12004327-B](#) [12010503-B](#) [12015308](#) [12015384](#) [12015909](#) [1-21030-1](#) [12041254](#) [12041318](#) [12047946-B](#)
[12047957](#) [12047957-L](#) [12059473](#) [12066261](#)