

REVISIONS				
P	LTR	DESCRIPTION	DATE	APVD
B	I	REVISED PER ECR-10-019377	30SEP2010	HMR TM
C		REVISED PER ECR-14-000206	26DEC2013	PV RB

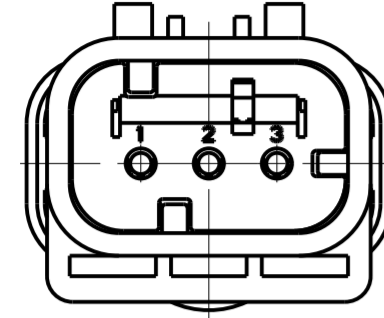

1717673-2
SCALE 2:1

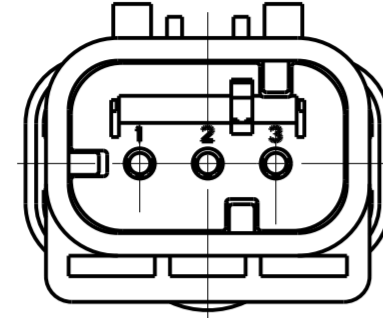

1717673-3
SCALE 2:1

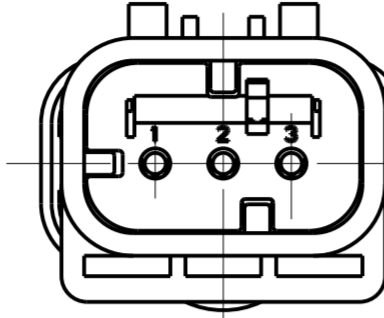

1717673-4
SCALE 2:1

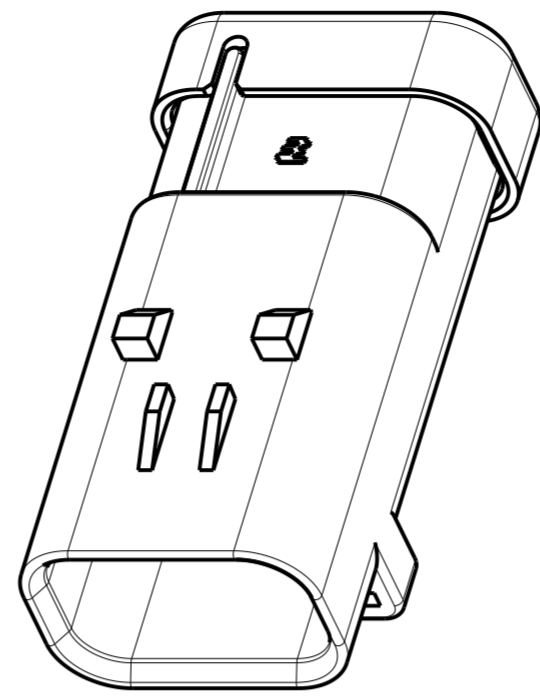

SCALE 2:1

- ① MATERIAL: 15% GLASS FILLED THERMOPLASTIC
COLOR: BLACK
- ② MATERIAL: 15% GLASS FILLED THERMOPLASTIC
COLOR: (SEE TABLE)
- ③ MATERIAL: SILICONE
COLOR: GREEN

4. WIRE INSULATION RANGE: $\varnothing 2.24 \sim \varnothing 3.94$

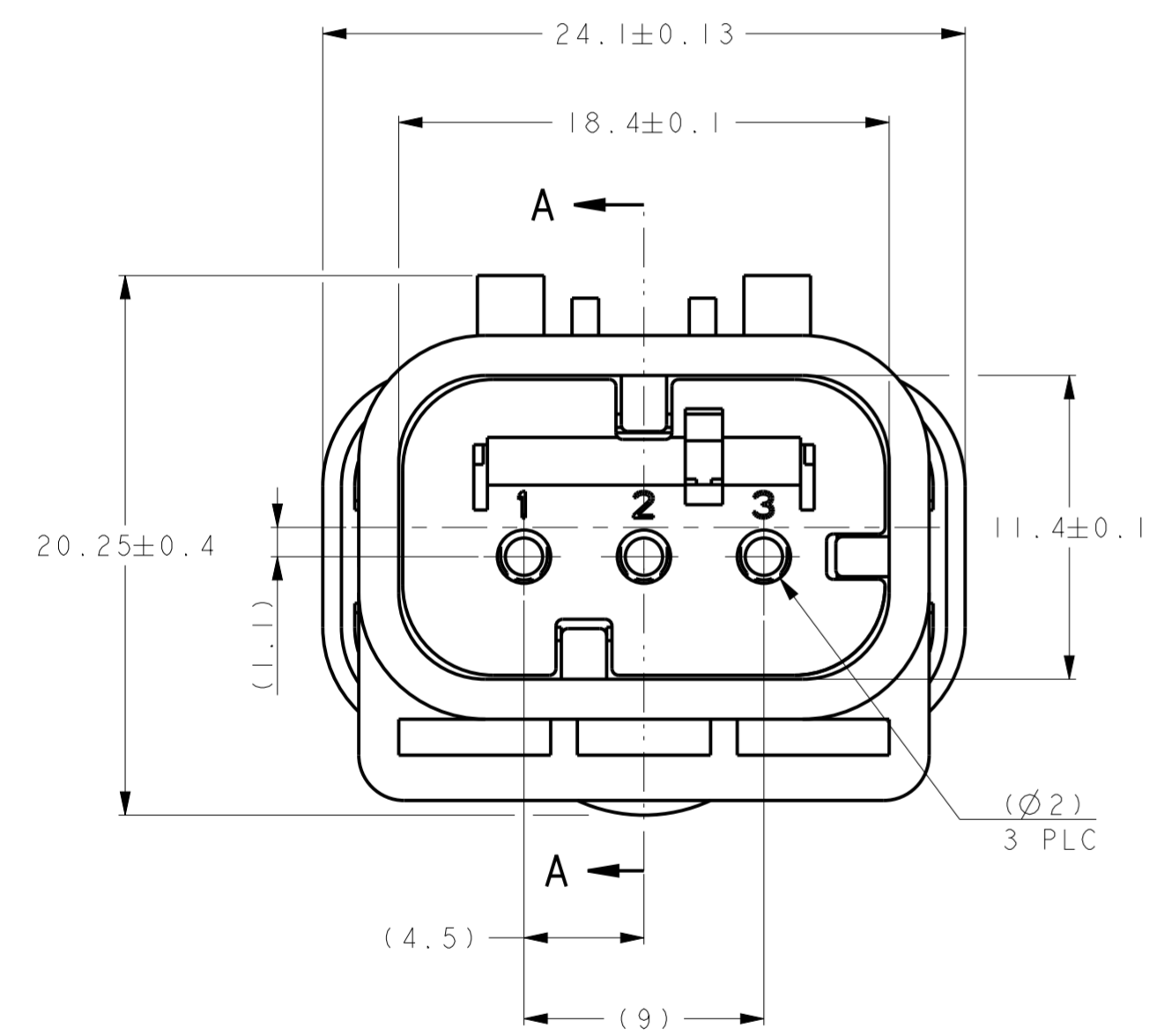

1717673-1 SHOWN

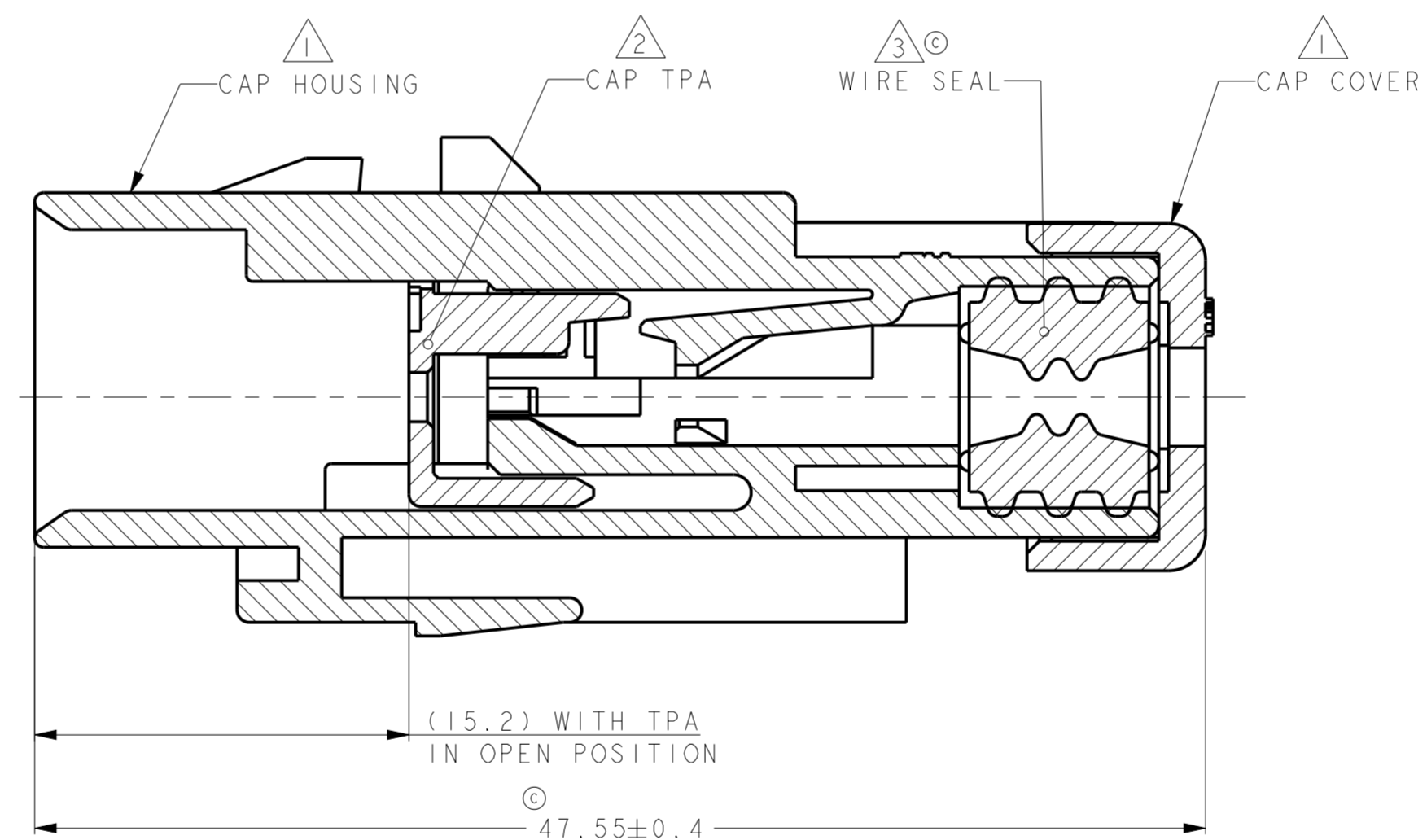

A - A
OPEN POSITION

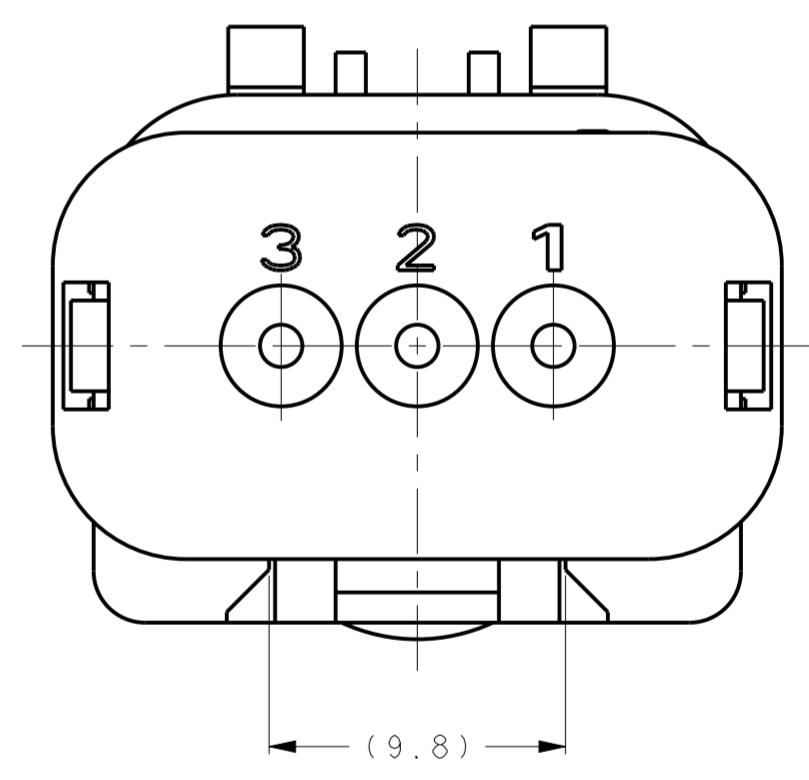

GREEN	1717673-4
YELLOW	1717673-3
GRAY	1717673-2
RED	1717673-1
TPA COLOR	PART NUMBER

THIS DRAWING IS A CONTROLLED DOCUMENT.		DWN Y. KATO 15JAN2004	TE Connectivity													
DIMENSIONS: mm		CHK S. MANABE 15JAN2004														
TOLERANCES UNLESS OTHERWISE SPECIFIED		APVD S. MANABE 15JAN2004														
<table border="1"> <tr> <td>0 PLC</td> <td>±</td> </tr> <tr> <td>1 PLC</td> <td>±</td> </tr> <tr> <td>2 PLC</td> <td>±</td> </tr> <tr> <td>3 PLC</td> <td>±</td> </tr> <tr> <td>4 PLC</td> <td>±</td> </tr> <tr> <td>ANGLES</td> <td>±</td> </tr> <tr> <td>FINISH</td> <td></td> </tr> </table>		0 PLC		±	1 PLC	±	2 PLC	±	3 PLC	±	4 PLC	±	ANGLES	±	FINISH	
0 PLC	±															
1 PLC	±															
2 PLC	±															
3 PLC	±															
4 PLC	±															
ANGLES	±															
FINISH																
MATERIAL		Customer Drawing	NAME CAP ASSY, 3 POS. BRACKET REVERSE TYPE AMP SEAL 16 SIZE CAGE CODE DRAWING NO A200779 C-1717673 RESTRICTED													
1471-9 (3/13)		SCALE 4:1	SHEET OF REV C													

X-ON Electronics

Largest Supplier of Electrical and Electronic Components

Click to view similar products for [Automotive Connectors](#) category:

Click to view products by [TE Connectivity](#) manufacturer:

Other Similar products are found below :

[003-018-000](#) [60403001](#) [60993906-B](#) [M902-2131](#) [M902-2161](#) [72.330.1035.1](#) [73.353.4028.0](#) [F119300-B](#) [F166900](#) [F258300-B](#) [F358300-B](#)
[F407400](#) [F444110](#) [F487000](#) [F509500B-B](#) [827153-1](#) [8N1515-32-24P](#) [9-1326729-8](#) [925474-1](#) [928905-1](#) [964562-4](#) [968782-1](#) [GT17SA-8DS-](#)
[HU](#) [98891-1012](#) [98947-1016](#) [12004147](#) [12004475-L](#) [12010290](#) [12010309-B](#) [12015454](#) [12020219-B](#) [12020308](#) [12041318-B](#) [12052225-L](#)
[12052466](#) [12059125](#) [12064869](#) [12004327-B](#) [12010503-B](#) [12015308](#) [12015384](#) [12015909](#) [1-21030-1](#) [12041254](#) [12041318](#) [12047946-B](#)
[12047957](#) [12047957-L](#) [12059473](#) [12066261](#)