

REVISIONS					
P	LTR	DESCRIPTION	DATE	DWN	APVD
B	I	REVISED PER ECR-10-019377	30SEP2010	HMR	T.M
C		REVISED PER ECR-14-000206	26DEC2013	DR	RB

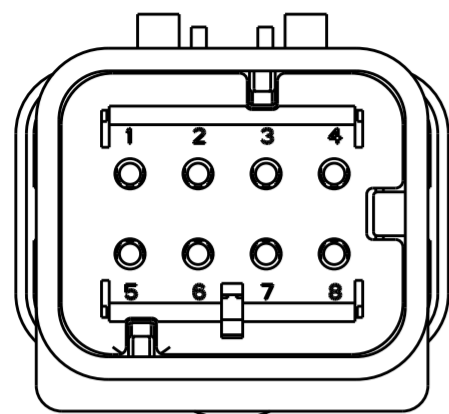

1717676-2
SCALE 2:1

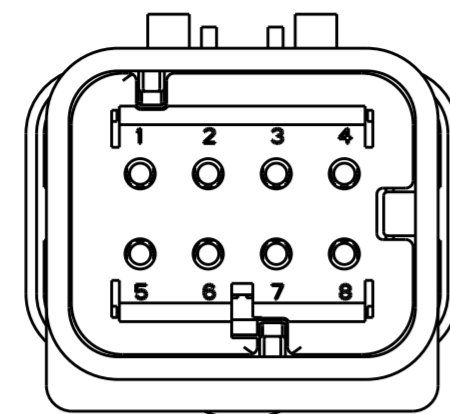

1717676-3
SCALE 2:1

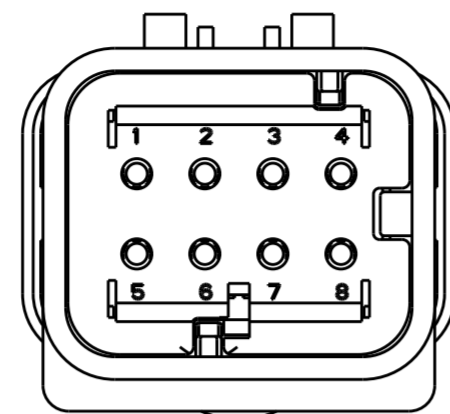

1717676-4
SCALE 2:1

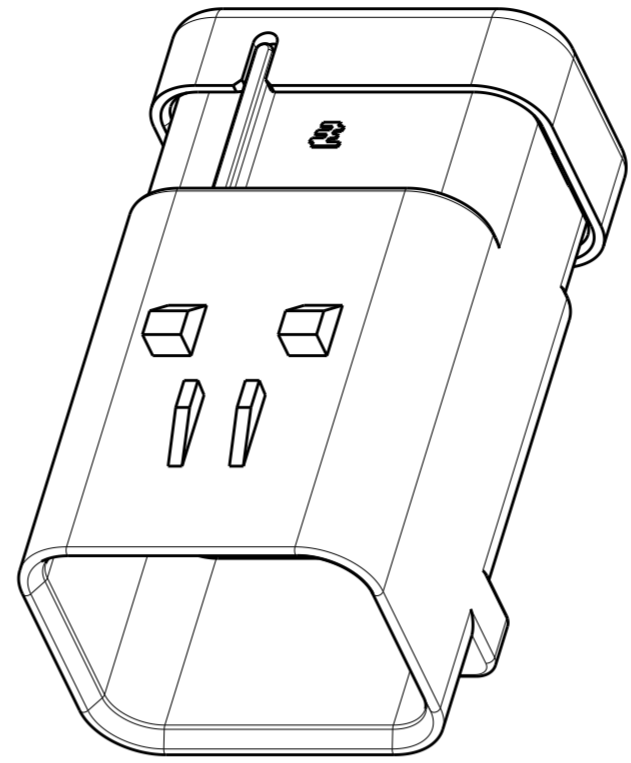

SCALE 2:1

- ① MATERIAL: 15% GLASS FILLED THERMOPLASTIC
COLOR: BLACK
- ② MATERIAL: 15% GLASS FILLED THERMOPLASTIC
COLOR: (SEE TABLE)
- ③ MATERIAL: SILICONE
COLOR: GREEN

4. WIRE INSULATION RANGE: $\varnothing 2.24 \sim \varnothing 3.94$

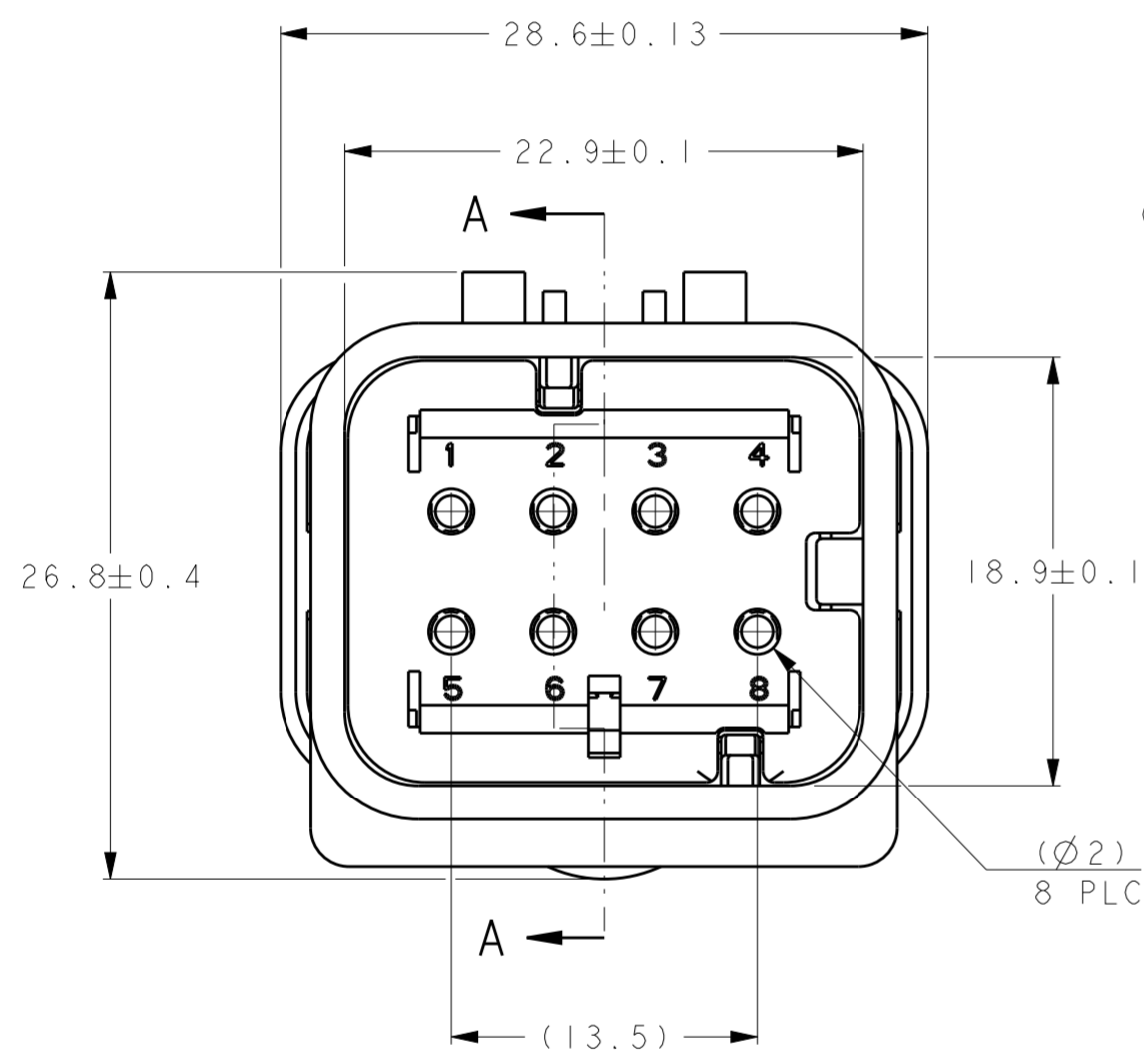

1717676-1 SHOWN

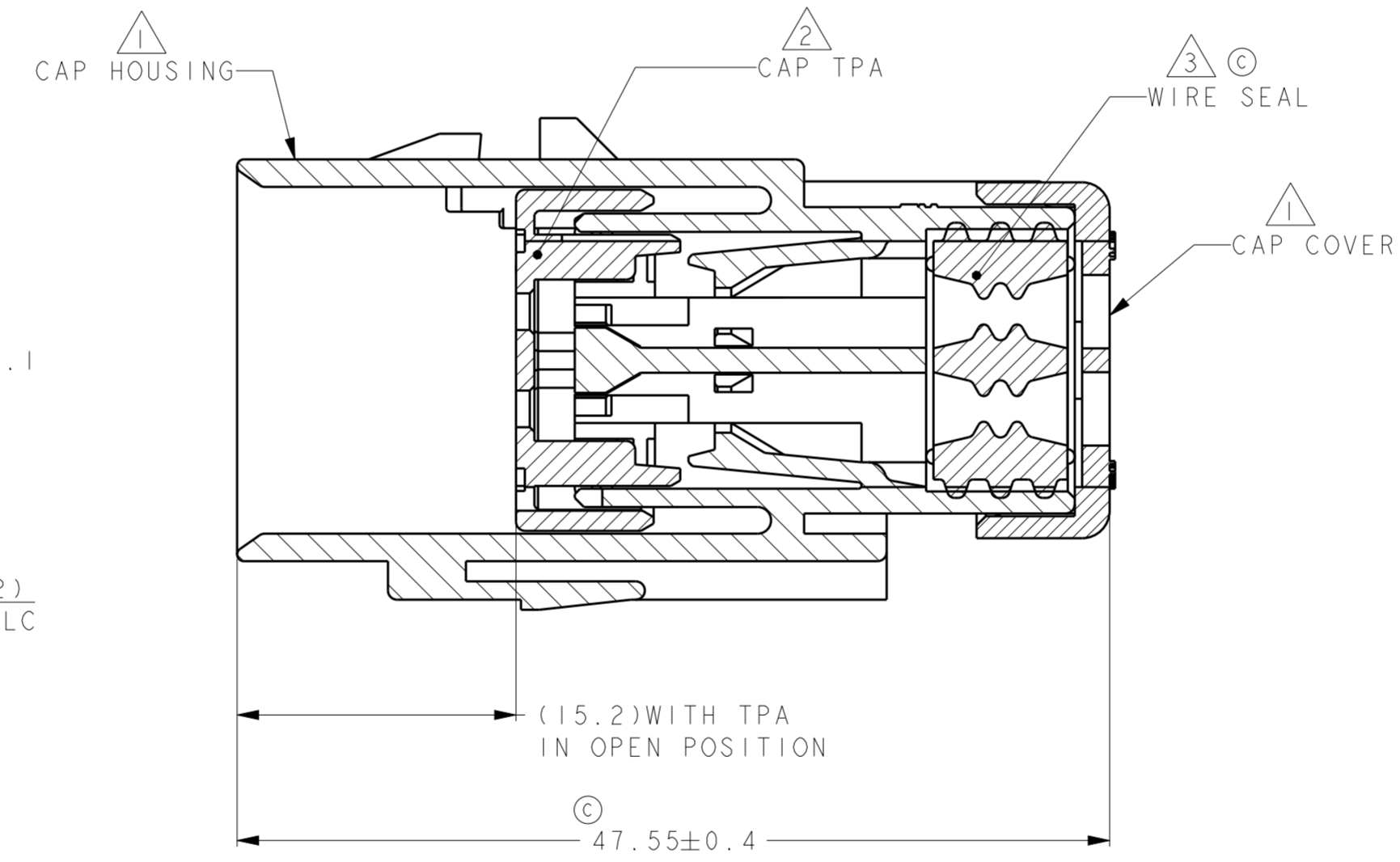

A - A
OPEN POSITION

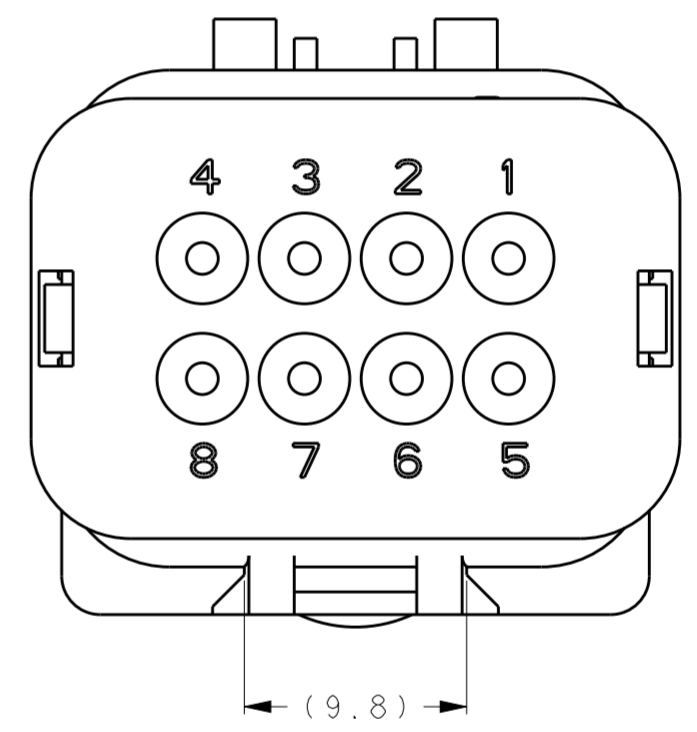

GREEN	1717676-4
YELLOW	1717676-3
GRAY	1717676-2
RED	1717676-1
TPA COLOR	PART NUMBER

THIS DRAWING IS A CONTROLLED DOCUMENT.		DWN Y. KATO 15JAN2004	TE Connectivity															
DIMENSIONS: mm		CHK S. MANABE 15JAN2004																
TOLERANCES UNLESS OTHERWISE SPECIFIED:		APVD S. MANABE 15JAN2004	NAME CAP ASSY, 8 POS. BRACKET REVERSE TYPE AMP SEAL 16															
<table border="1"> <tr><td>0 PLC</td><td>±</td></tr> <tr><td>1 PLC</td><td>±0.5</td></tr> <tr><td>2 PLC</td><td>±0.13</td></tr> <tr><td>3 PLC</td><td>±0.013</td></tr> <tr><td>4 PLC</td><td>±0.0001</td></tr> <tr><td>ANGLES</td><td>±</td></tr> <tr><td>FINISH</td><td>-</td></tr> </table>		0 PLC	±	1 PLC	±0.5	2 PLC	±0.13	3 PLC	±0.013	4 PLC	±0.0001	ANGLES	±	FINISH	-	PRODUCT SPEC 108-2184	SIZE A20779	
0 PLC	±																	
1 PLC	±0.5																	
2 PLC	±0.13																	
3 PLC	±0.013																	
4 PLC	±0.0001																	
ANGLES	±																	
FINISH	-																	
MATERIAL TBD		APPLICATION SPEC 114-13065	DRAWING NO C-1717676															
		WEIGHT -	RESTRICTED TO															
		CUSTOMER DRAWING	SCALE 3:1 SHEET 1 OF 1 REV C															

X-ON Electronics

Largest Supplier of Electrical and Electronic Components

Click to view similar products for [Automotive Connectors](#) category:

Click to view products by [TE Connectivity](#) manufacturer:

Other Similar products are found below :

[003-018-000](#) [60403001](#) [60993906-B](#) [M902-2131](#) [M902-2161](#) [M902-2344](#) [72.330.1035.1](#) [73.353.4028.0](#) [F119300-B](#) [F166900](#) [F258300-B](#)
[F358300-B](#) [F407400](#) [F444110](#) [F487000](#) [F509500B-B](#) [827153-1](#) [8N1515-32-24P](#) [9-1326729-8](#) [925474-1](#) [928905-1](#) [964562-4](#) [968782-1](#)
[GT17SA-8DS-HU](#) [98891-1012](#) [98947-1016](#) [12004147](#) [12004475-L](#) [12010290](#) [12010309-B](#) [12015454](#) [12020219-B](#) [12041318-B](#) [12052225-](#)
[L](#) [12052466](#) [12064869](#) [12004327-B](#) [12015308](#) [12015384](#) [12015909](#) [1-21030-1](#) [12041254](#) [12041318](#) [12047946-B](#) [12047957](#) [12047957-L](#)
[12059473](#) [12066261](#) [12110546](#) [12110546-B](#)