

LOC J	DIST	REVISIONS					
		P	LTR	DESCRIPTION	DATE	DWN	APVD
		F2		REVISED PER ECO-11-005140	01APR11	RK	HMR

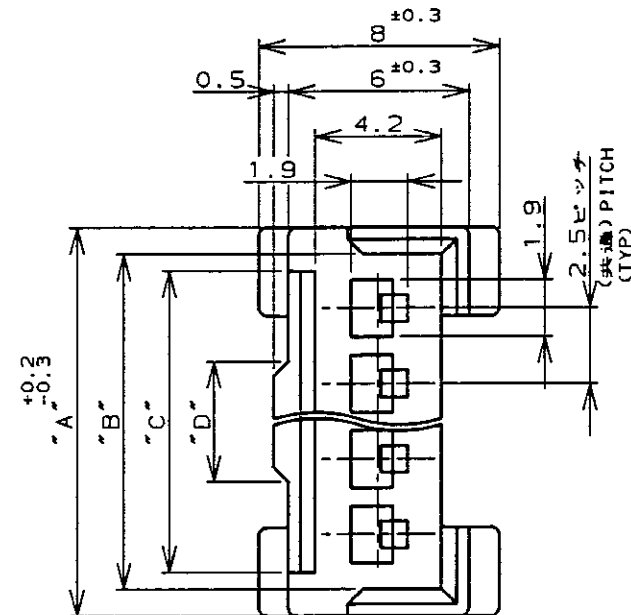

2~6Pos.: AS SHOWN  
 2~6極品: 本図  
 (8, 10, 12極品はSHEET 2/2を参照)  
 (8, 10, 12Pos. -SEE SHEET 2/2)

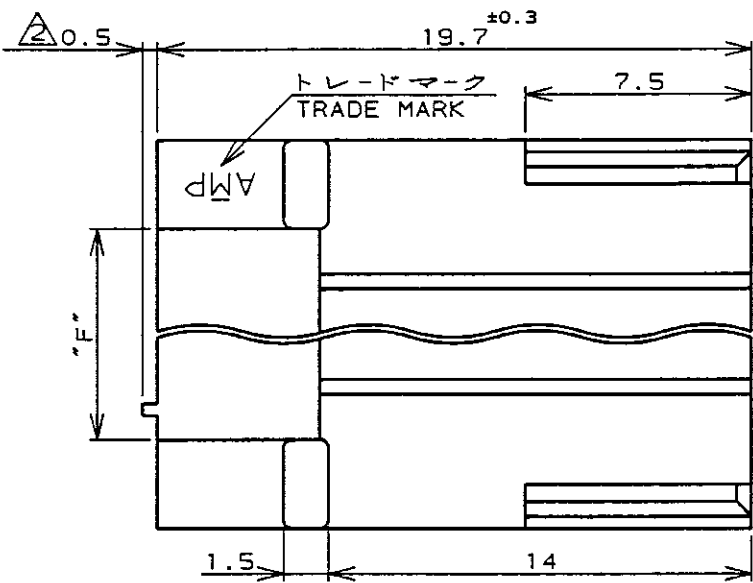
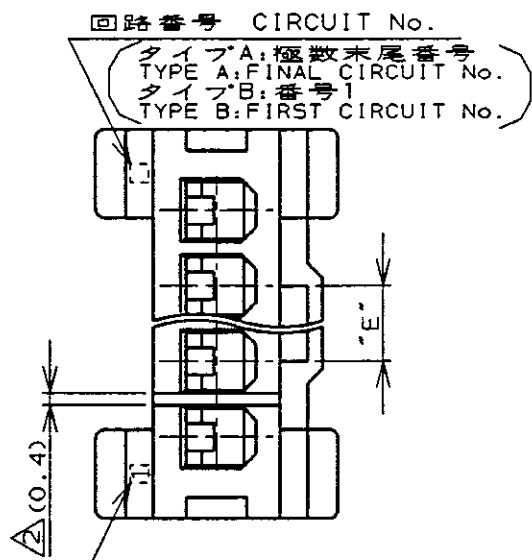
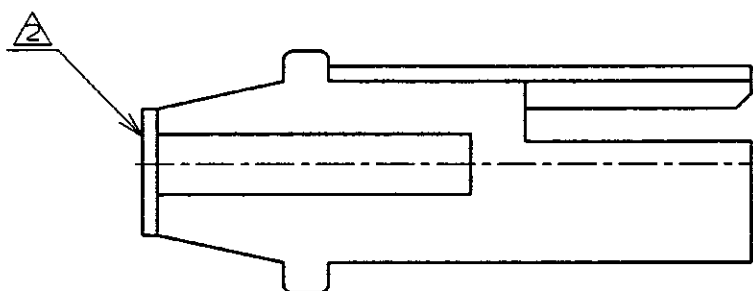
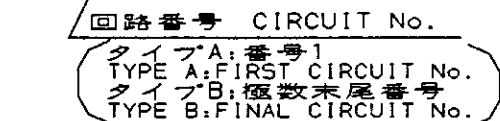

NOTES;

- APPLICABLE CONTACT NUMBER:  
 170376 (AWG #20-#26)  
 170377 (AWG #26-#30)
- APPLY TO 2Pos. HOUSING ONLY.

**4**  
 OBSOLETE

B (逆転) REVERSE TYPE	171880	(12)	▲	▲	15	16.1	17.9	6			4- ▲	-6	2- ▲	-6	▲	-6	
		(9.5)			12.5	13.6	15.4	5			4-	-5	2-	-5		-5	
		(7)			10	11.1	12.9	4			4-	-4	2-	-4		-4	
		(4.5)	2.5	4	7.5	8.6	10.4	3			4-	-3	2-	-3		-3	
		(2)	2	3.5	5	6.1	7.9	2			4-172212-2		2-172212-2			172212-2	
A (標準) STANDARD TYPE	171822	(12)	▲	▲	15	16.1	17.9	6			4- ▲	-6	2- ▲	-6	▲	-6	
		(9.5)			12.5	13.6	15.4	5			4-	-5	2-	-5		-5	
		(7)			10	11.1	12.9	4			4-	-4	2-	-4		-4	
		(4.5)	2.5	4	7.5	8.6	10.4	3	8- ▲	-3	6- ▲	-3	4-	-3	2-	-3	-3
		(2)	2	3.5	5	6.1	7.9	2	8-172211-2		6-172211-2		4-172211-2		2-172211-2		172211-2
回路番号 タイプ CIRCUIT No. TYPE	嵌合相手 ハウジング型番 MATING COUNTER PARTS No.	"F"	"E"	"D"	"C"	"B"	"A"	極数 Pos.	赤色 RED	緑色 GREEN	青色 BLUE	黒色 BLACK	自然色 NATURAL	型番 PARTS No.			

注記

- 適用コンタクト型番: 170376 (AWG #20-#26)  
 170377 (AWG #26-#30)
- 2極品にのみ適用
- OBSOLETE PARTS: OBSOLETE CIS STREAMLINING PER D.RENAUD/D.SINISI

DIMENSIONS: 単位: 英 mm		TOLERANCES UNLESS OTHERWISE SPECIFIED		DWN H. Hoskins 8/1/96		TE Connectivity	
MATERIAL 材料 66ナイロン 66NYLON (UL94V-0)		FINISH 色: 表参照 COLOR: SEE TABLE		APVD A. Tanigawa 8/1/96		NAME EI シリーズ コネクタ (電線対電線) EI SERIES CONNECTOR (Wire-to-Wire) フリーハンギングタイプ キャップハウジング FREE HANGING TYPE CAP HOUSING	
PRODUCT SPEC 製品規格 108-5118		APPLICATION SPEC 取付適用規格 114-5035		WEIGHT		SIZE A3	
CUSTOMER DRAWING		SCALE 尺度 4-1		SHEET 1 OF 2		DRAWING NO. 番号 C-172211	

LOC J	DIST	REVISIONS						
		P	LTR	DESCRIPTION	ECN	DATE	DWN	APVD
				SHEET 1/2 参照	SEE SHEET 1/2			

8, 10, 12Pos.: AS SHOWN  
 8, 10, 12極品: 本図  
 (2-6極品はSHEET 1/2を参照)  
 (2-6Pos.-SEE SHEET 1/2)

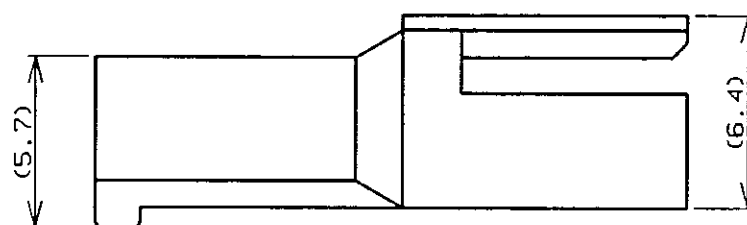
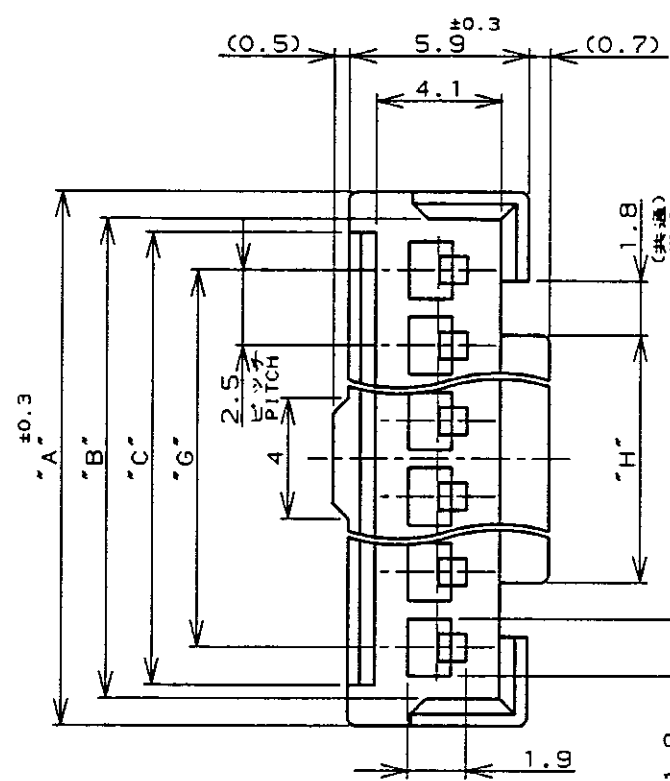
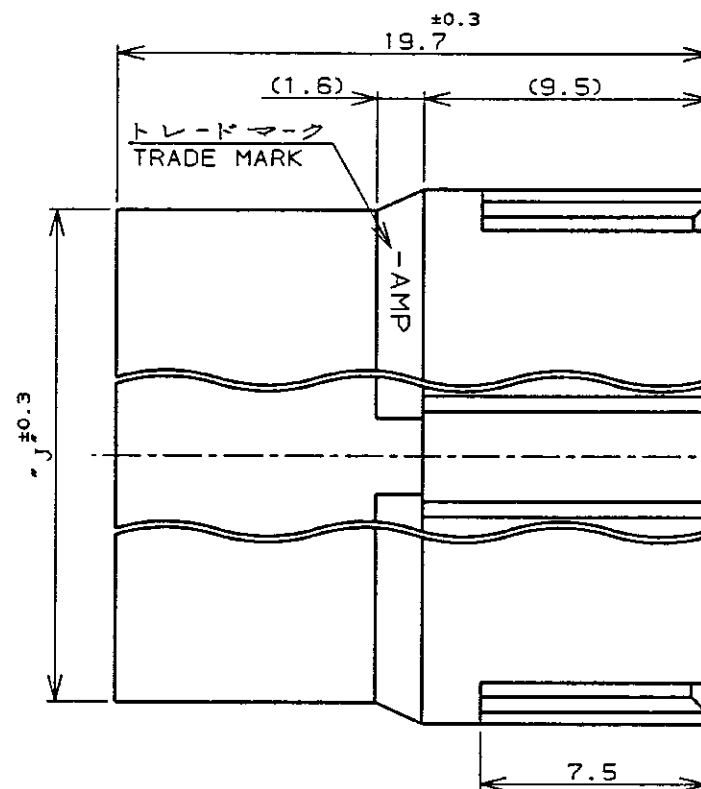
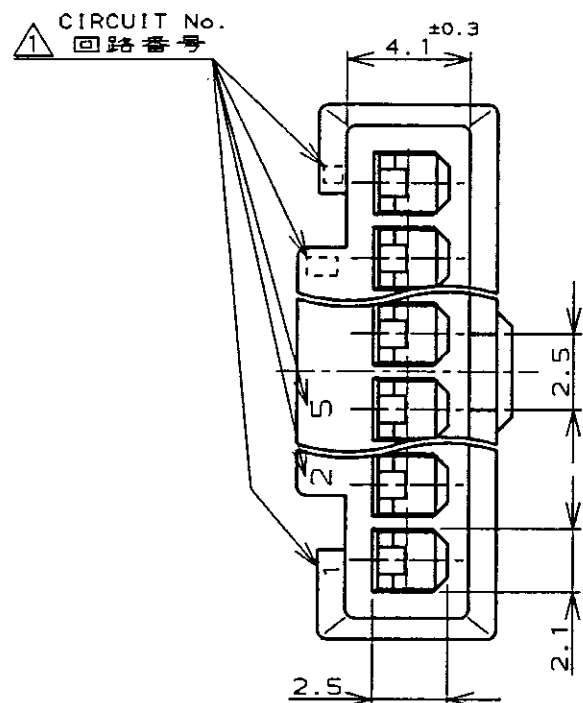

NOTES;

△ CIRCUIT NUMBER: INDICATE EACH TWO NUMBERS FROM THE FIRST, FINAL AND CIRCUIT No.5.

2. APPLICABLE CONTACT NUMBER:

170376 (AWG #20-#26)

170377 (AWG #26-#30)

3. MATING COUNTER PARTS NUMBER: 171822

注記;

△ 回路番号は表示は1, 2, 5及び最終番号(極数)とその1番前の番号のみ。

2. 通用コンタクト型番: 170376 (AWG #20-#26)

170377 (AWG #26-#30)

3. 嵌合相手リセハウジング型番: 171822

黒色 BLACK	21.3	13.2	17.5	20	20.9	22.7	8	2-	▲	-8
自然色 NATURAL	31.3	23.2	27.5	30	30.9	32.7	12	1-		-2
	26.3	18.2	22.5	25	25.9	27.7	10	1-		-0
ハウジング色 HOUSING COLOR	21.3	13.2	17.5	20	20.9	22.7	8			172211-8
	寸法 DIMENSIONS						極数 Pos.	型番 PARTS No.		

DIMENSIONS 単位: 概 mm		TOLERANCES UNLESS OTHERWISE SPECIFIED		DWN 14. Washino 8/1 '96		TE Connectivity	
		一般公差 10% : ±0.2 30% : ±0.25 50% : ±0.3 100% : ±0.3 ANGLE : ±3°		CHK A. Tanigawa 8/1 '96		NAME 名称	
				APVD S. Kubouchi 8/1 '96		EI シリーズ コネクタ (電線対電線) EI SERISE CONNECTOR (Wire-to-Wire)	
MATERIAL 材料 66ナイロン 66NYLON (UL94V-0)		FINISH 色: 表参照 COLOR: SEE TABLE		PRODUCT SPEC 製品規格 108-5118		フリーハンギングタイプ キャップハウジング FREE HANGING TYPE CAP HOUSING.	
				APPLICATION SPEC 取付適用規格 114-5035		DRAWING NO 番号	
				WEIGHT		A3 00779 C-172211	
				CUSTOMER DRAWING		SCALE 尺度 4-1	
						SHEET 2 OF 2	
						REV F2	

## X-ON Electronics

Largest Supplier of Electrical and Electronic Components

*Click to view similar products for [Headers & Wire Housings](#) category:*

*Click to view products by [TE Connectivity](#) manufacturer:*

Other Similar products are found below :

[892-18-020-10-001101](#) [58102-G61-06LF](#) [582553-1](#) [0009485154](#) [009176003701906](#) [0050291907](#) [LY20-4P-DT1-P1E-BR](#) [02.125.8002.8](#)  
[609-3404](#) [61062-3](#) [61082-181009](#) [622-3653LF](#) [63453-116](#) [636-1030](#) [636-1427](#) [636-3427](#) [636-4007](#) [641938-9](#) [641991-4](#) [644827-2](#) [65817-](#)  
[010LF](#) [65817-015LF](#) [65863-015LF](#) [66207-023LF](#) [67095-007LF](#) [67601157](#) [68645-018](#) [68648-049](#) [70.362.1628.0](#) [70-4210](#) [70-4226B](#) [70-](#)  
[4853B](#) [707-5020](#) [707-5028](#) [71.350.2428.0](#) [71918-208LF](#) [71961-016LF](#) [733-134](#) [733-162](#) [754199-000](#) [760-3052](#) [787-8014-00](#) [79531-3000](#)  
[FCN-360C032-B](#) [FCN-367T-T012/H](#) [FCN-723D010/2](#) [80.063.4001.1](#) [800-90-001-10-001000](#) [800-90-010-10-002000](#) [801-43-002-10-013000](#)