

172774-1 ✓ ACTIVE

AMP | Multilock Connector System

TE Internal #: 172774-1

Multilock Connector System, Automotive Terminals, Receptacle,
Tab Width .118 in [3 mm], Tab Thickness .025 in [.65 mm]

[View on TE.com >](#)



Terminals & Splices > Automotive Terminals > MULTILOCK, RECEPTACLE AND TAB



Terminal & Splice Type: **Receptacle**

Mating Tab Width: **3 mm [.118 in]**

Mating Tab Thickness: **.65 mm [.025 in]**

Terminal Transmits: **0 – 24 A (Low Power)**

Wire Size: **20 – 14 AWG**

[All MULTILOCK, RECEPTACLE AND TAB \(144\)](#)

Features

Product Type Features

Receptacle Style	180°
Sealable	No
Primary Locking Feature	Clean Body

Contact Features

Crimp Type	F-Crimp
Terminal & Splice Type	Receptacle
Mating Tab Width	3 mm [.118 in]
Mating Tab Thickness	.65 mm [.025 in]
Automotive Terminal Interface Plating	Tin (Sn)
Contact Termination Area Plating Material	Tin (Sn)

Termination Features

Termination Method to Wire & Cable	Crimp
Automotive Terminal Termination Method	Wire

Dimensions

Wire Size	.5 – 2 mm ²
Wire Size Search	14 AWG, 15 AWG, 16 AWG, 17 AWG, 18 AWG, 19 AWG, 20 AWG



Wire Insulation Diameter	2.1 – 3.38 mm [.082 – .133 in]
--------------------------	--------------------------------

Usage Conditions

Insulation Requirement	Uninsulated
Operating Temperature (Max)	80 °C, 85 °C, 90 °C, 100 °C, 105 °C [176 °F][185 °F][194 °F][212 °F][221 °F]
Operating Temperature Range	-30 – 105 °C [-22 – 221 °F]

Packaging Features

Packaging Method	Bag
Packaging Quantity	1000

Other

Terminal Transmits	0 – 24 A (Low Power)
--------------------	----------------------

Product Compliance

[For compliance documentation, visit the product page on TE.com>](#)

EU RoHS Directive 2011/65/EU	Compliant
EU ELV Directive 2000/53/EC	Compliant
China RoHS 2 Directive MIIT Order No 32, 2016	No Restricted Materials Above Threshold
EU REACH Regulation (EC) No. 1907/2006	Current ECHA Candidate List: JUL 2021 (219) Candidate List Declared Against: JUL 2021 (219) Does not contain REACH SVHC
Halogen Content	Low Halogen - Br, Cl, F, I < 900 ppm per homogenous material. Also BFR/CFR/PVC Free
Solder Process Capability	Not applicable for solder process capability

Product Compliance Disclaimer

This information is provided based on reasonable inquiry of our suppliers and represents our current actual knowledge based on the information they provided. This information is subject to change. The part numbers that TE has identified as EU RoHS compliant have a maximum concentration of 0.1% by weight in homogenous materials for lead, hexavalent chromium, mercury, PBB, PBDE, DBP, BBP, DEHP, DIBP, and 0.01% for cadmium, or qualify for an exemption to these limits as defined in the Annexes of Directive 2011/65/EU (RoHS2). Finished electrical and electronic equipment products will be CE marked as required by Directive 2011/65/EU. Components may not be CE marked. Additionally, the part numbers that TE has identified as EU ELV compliant have a maximum concentration of 0.1% by weight in homogenous materials for lead, hexavalent chromium, and mercury, and 0.01% for cadmium, or qualify for an exemption to these limits as defined in the Annexes of Directive 2000/53/EC (ELV). Regarding the REACH Regulation, the information TE provides on SVHC in articles for this part number is based on the latest European Chemicals Agency (ECHA) 'Guidance on requirements for substances in articles' posted at this URL: <https://echa.europa.eu/guidance-documents/guidance-on-reach>

Compatible Parts



TE Part # 1804014-1
CCII MIC MK-II REC 20-14 ASSY



TE Part # 753787-1
EXTRACTION TOOL FOR MIC MK II



TE Part # 172500-1
MIC MARK-2 PLUG HSG 17P



TE Part # 172497-1
MIC MARK-2 PLUG HSG 11P



TE Part # 172501-1
MIC MARK-2 PLUG HSG 21P



TE Part # 172496-1
MIC PLUG HSG 9P (MK II)



TE Part # 172494-1
MIC MARK-2 PLUG HSG 5P

Also in the Series | Multilock Connector System

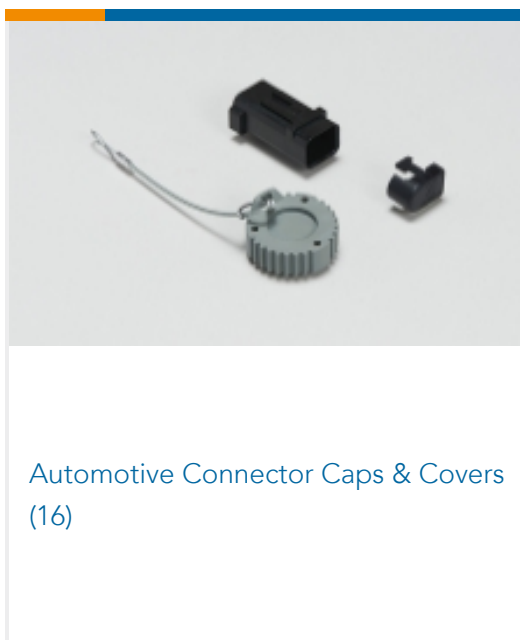

Automotive Connector Caps & Covers
(16)



Automotive Connector EMC Shielding
(1)



Automotive Connector Locks &
Position Assurance(2)

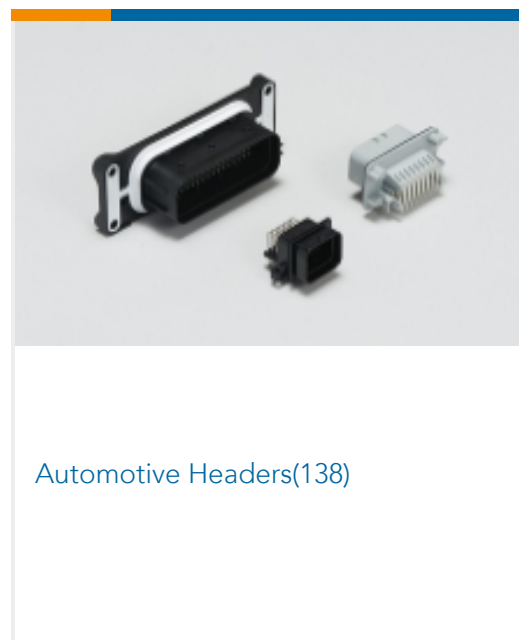

Automotive Headers(138)

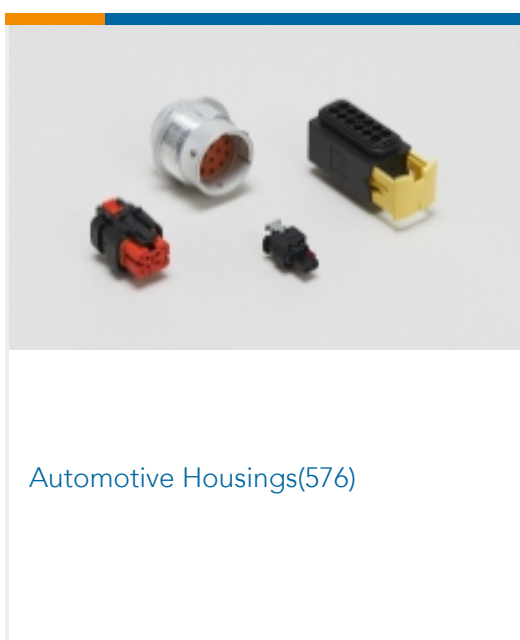

Automotive Housings(576)



Automotive Seals & Cavity Plugs(2)

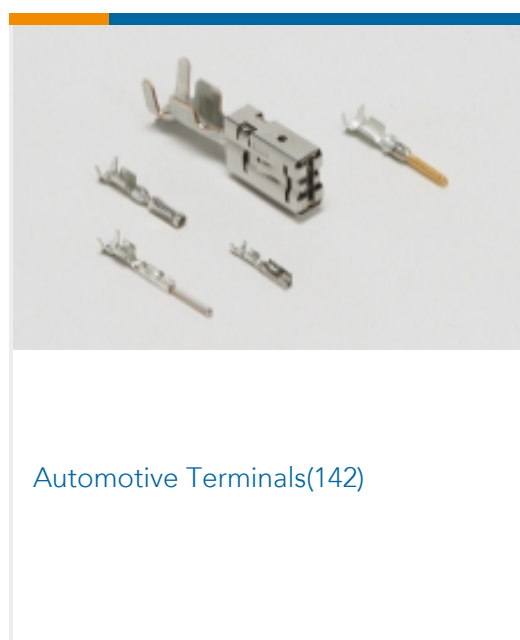

Automotive Terminals(142)

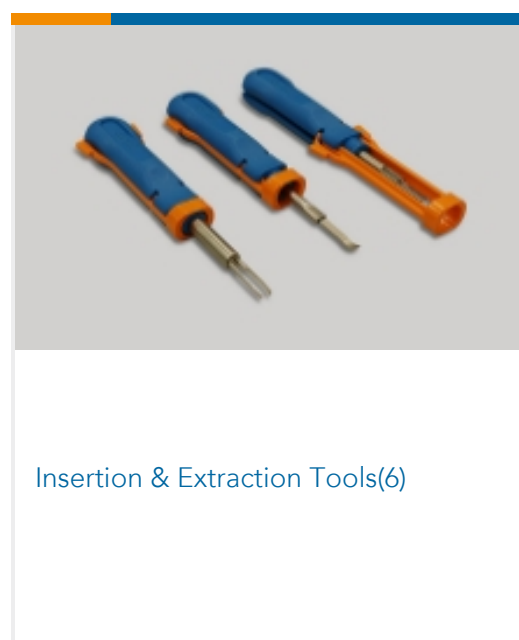

Insertion & Extraction Tools(6)

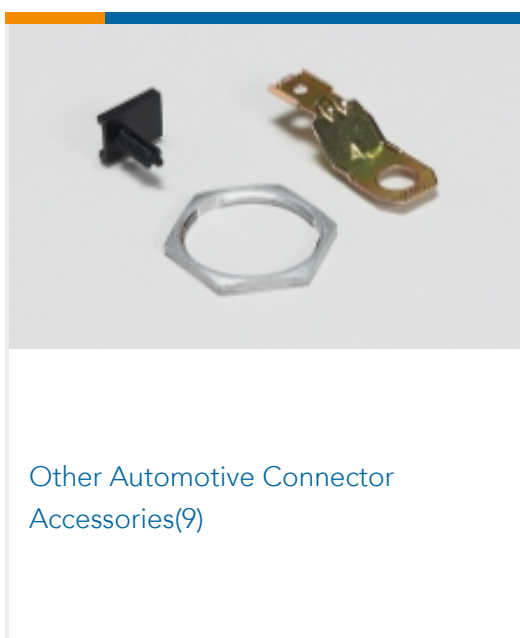

Other Automotive Connector
Accessories(9)

Customers Also Bought

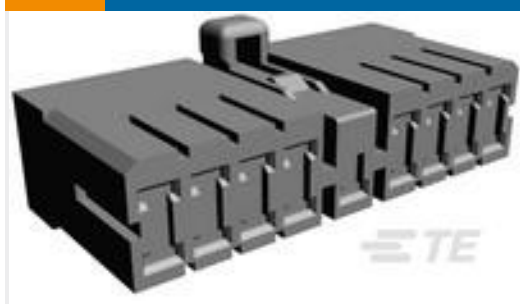

TE Part #172500-1
MIC MARK-2 PLUG HSG 17P

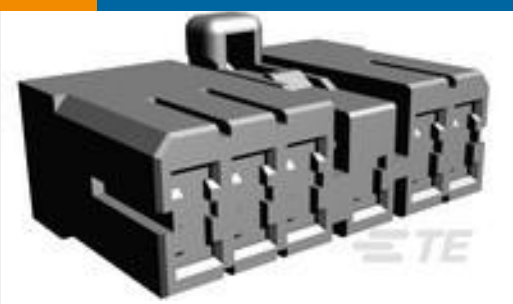

TE Part #172497-1
MIC MARK-2 PLUG HSG 11P



TE Part #172496-1
MIC PLUG HSG 9P (MK II)



TE Part #172494-1
MIC MARK-2 PLUG HSG 5P



TE Part #170108-2
FF 250 REC 18-14AWG TPPB LP

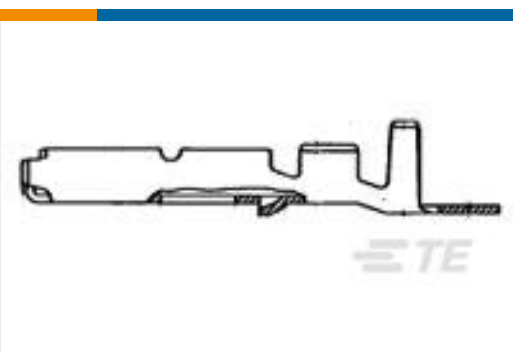

TE Part #172776-1
MIC MARK-2 REC CONTACT L.P.



TE Part #171190-1
FF 250 TAB HSG 6P NYLON NAT

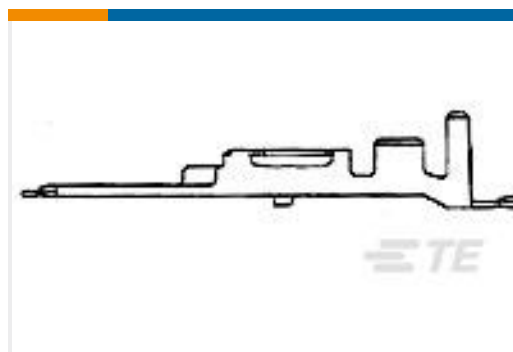

TE Part #172778-1
MIC MK-2 TAB LP

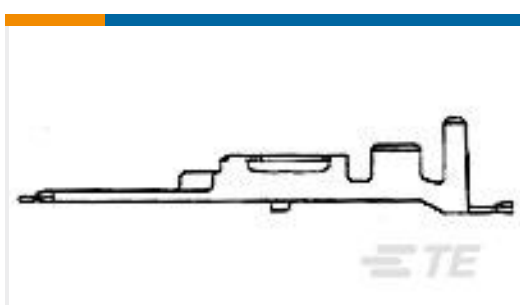

TE Part #172778-4
MIC MK-II TAB LP

Documents

Product Drawings

[RECP CONT MULTILOCK MIC MARKII](#)

Japanese

[RECP CONT MULTILOCK MIC MARKII](#)

Japanese

CAD Files

[3D PDF](#)

3D

Customer View Model

[ENG_CVM_CVM_172774-1_U.2d_dxf.zip](#)

English

Customer View Model

[ENG_CVM_CVM_172774-1_U.3d_igs.zip](#)

English

Customer View Model

[ENG_CVM_CVM_172774-1_U.3d_stp.zip](#)



English

By downloading the CAD file I accept and agree to the [Terms and Conditions](#) of use.

Datasheets & Catalog Pages

MULTILOCK Connector System

English

Product Specifications

Application Specification

English

Crimping Multi-Interlock (MIC) Conn. Mark II, Rec. Contact

English

Instruction Sheets

Instruction Sheet (non U.S.)

English

Multi-Interlock Mark II Contact From Plug & Cap HSG

English

Instruction Sheet (non U.S.)

Japanese

X-ON Electronics

Largest Supplier of Electrical and Electronic Components

Click to view similar products for [Automotive Connectors](#) category:

Click to view products by [TE Connectivity](#) manufacturer:

Other Similar products are found below :

[003-018-000](#) [60403001](#) [60993906-B](#) [M902-2131](#) [M902-2161](#) [M902-2344](#) [72.330.1035.1](#) [73.353.4028.0](#) [F119300-B](#) [F166900](#) [F258300-B](#)
[F358300-B](#) [F407400](#) [F444110](#) [F487000](#) [F509500B-B](#) [827153-1](#) [8N1515-32-24P](#) [9-1326729-8](#) [925474-1](#) [928905-1](#) [964562-4](#) [968782-1](#)
[GT17SA-8DS-HU](#) [98891-1012](#) [98947-1016](#) [12004147](#) [12004475-L](#) [12010290](#) [12010309-B](#) [12015454](#) [12020219-B](#) [12041318-B](#) [12052225-](#)
[L](#) [12052466](#) [12064869](#) [12004327-B](#) [12015308](#) [12015384](#) [12015909](#) [1-21030-1](#) [12041254](#) [12041318](#) [12047946-B](#) [12047957](#) [12047957-L](#)
[12059473](#) [12066261](#) [12110546](#) [12110546-B](#)