

P	LTR	DESCRIPTION	DATE	DMN	APVD
-	-	SEE SHEET 1	-	-	-

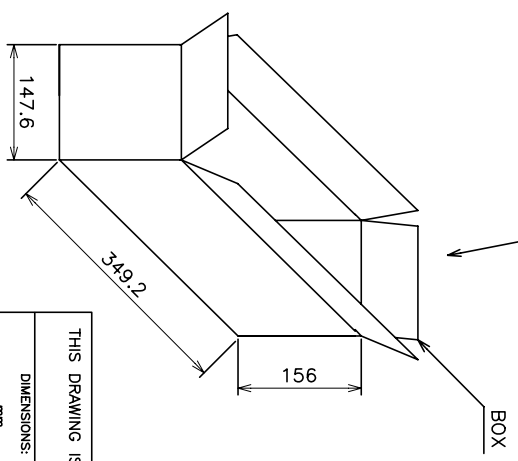
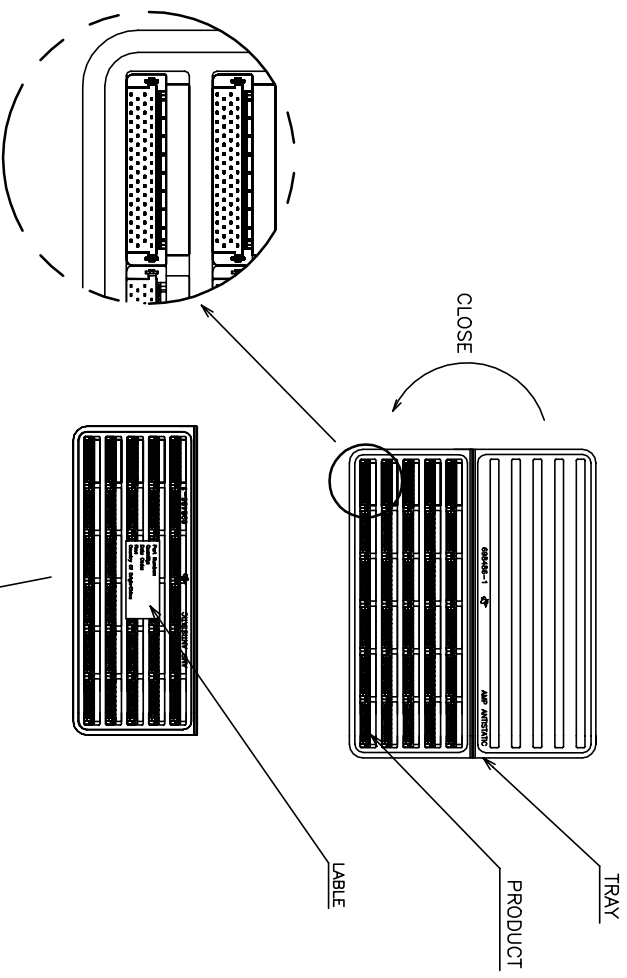

POS.	QTY/ TRAY	TRAY/ BOX	QTY/ BOX	N/W (KG)	G/W (KG)	PART NUMBER
40	45	10	450	1.71	2.66	5-1734099-4
						6-1734099-8
						3-1734099-8
						1-1734099-8
160	10	10	100	1.18	2.13	5-1734099-6
						3-1734099-6
						1-1734099-6
120	15	10	150	1.20	2.15	3-1734099-2
						1-1734099-2
68	30	10	300	1.69	2.64	4-1734099-7
						2-1734099-7
						1734099-7
60	30	10	300	1.53	2.48	4-1734099-6
						2-1734099-6
						1734099-6
50	35	10	350	1.58	2.56	4-1734099-5
						2-1734099-5
						1734099-5
40	45	10	450	1.71	2.66	4-1734099-4
						2-1734099-4
						1734099-4

THIS DRAWING IS A CONTROLLED DOCUMENT.

DIMENSIONS:	TOLERANCES UNLESS OTHERWISE SPECIFIED:
mm	
0 P/C	±
1 P/C	±
2 P/C	±
3 P/C	±
4 P/C	±
ANGLES	±

DMN	CHK	APVD
-	-	-

NAME	SIZE	QAGE CODE	DRAWING NO	RESTRICTED TO
PLUG ASSEMBLY, R/A, BTB, CHAMP .050, SERIES I	A3	00779	1734099	

MATERIAL	FINISH	WEIGHT	CUSTOMER DRAWING
-	-	-	-

REVISIONS					
P	LTR	DESCRIPTION	DATE	DMN	APVD
-	-	SEE SHEET 1	-	-	-

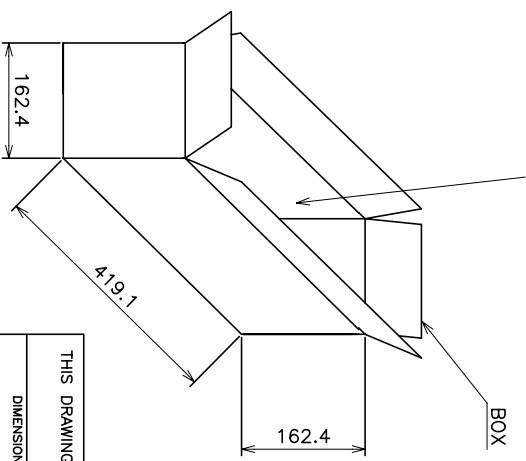
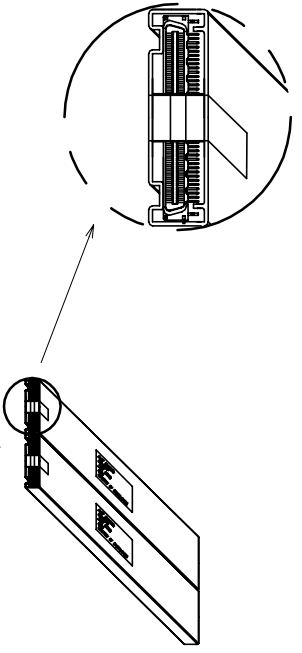
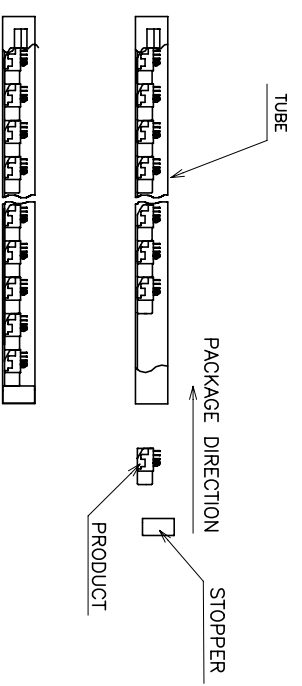

POS.	QTY/ TUBE	TUBE/ BOX	QTY/ BOX	N/W (KG)	G/W (KG)	PART NUMBER
100	21	16	336	2.60	3.44	5-1734099-0 3-1734099-0 1-1734099-0
80	21	16	336	2.15	3.00	4-1734099-8 2-1734099-8 1734099-8

THIS DRAWING IS A CONTROLLED DOCUMENT.

DIMENSIONS:	TOLERANCES UNLESS OTHERWISE SPECIFIED:
mm	
0 P/C	±
1 P/C	±
2 P/C	±
3 P/C	±
4 P/C	±
ANGLES	±
FINISH	



DMN	CHK	APVD	PRODUCT SPEC	APPLICATION SPEC	WEIGHT
-	-	-	-	-	-

STE TE Connectivity

PLUG ASSEMBLY, R/A,
BTB, CHAMP .050, SERIES I

SIZE: A3
CAGE CODE: 00779
DRAWING NO: 1734099

RESTRICTED FOR CUSTOMER DRAWING

REVISIONS		DATE	DMN	APVD
P	LIR			
	SEE SHEET 1			

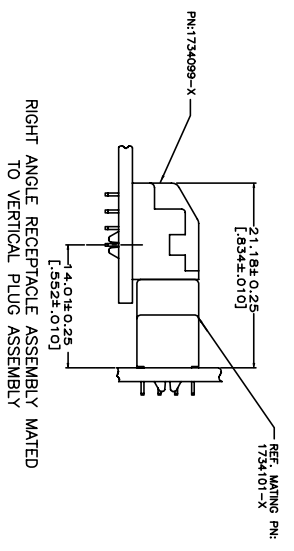
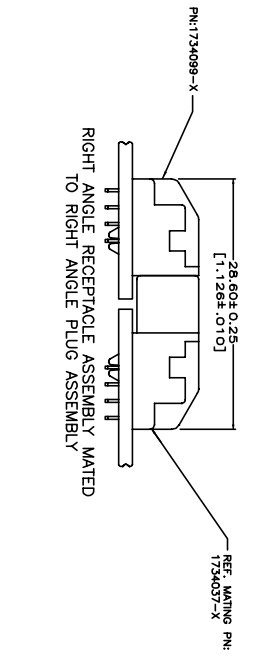
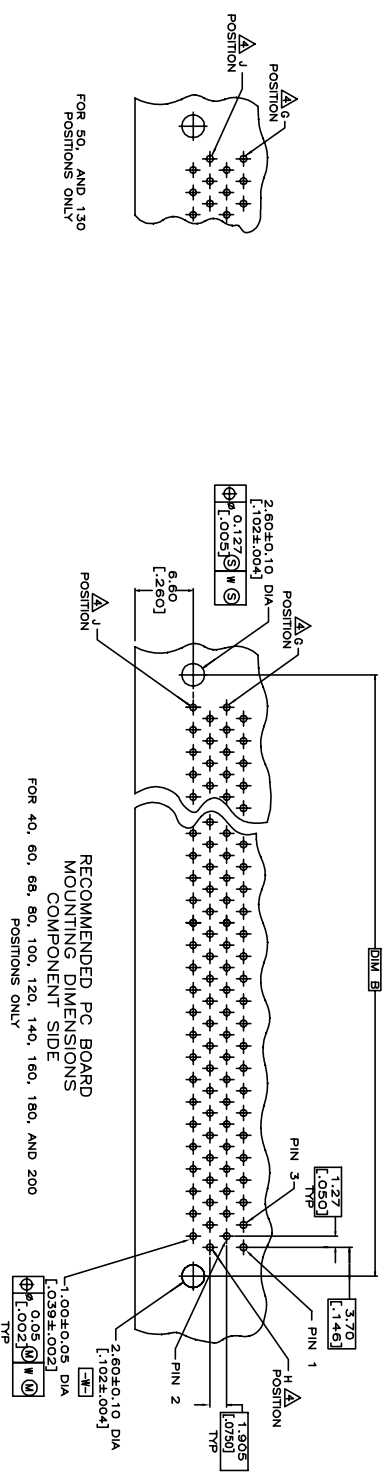

THIS DRAWING IS A CONTROLLED DOCUMENT.

DIMENSIONS:	mm	TOLERANCES UNLESS OTHERWISE SPECIFIED:	DMN	CHK	APVD	NAME
0 P/C		±				 TE Connectivity PLUG ASSEMBLY, R/A, BTB, CHAMP .050, SERIES I
1 P/C		±				
2 P/C		±				
3 P/C		±				
4 P/C		±				
ANGLES		±				
MATERIAL						

FINISH

APVD

PRODUCT SPEC

APPLICATION SPEC

WEIGHT

CUSTOMER DRAWING

SIZE A3

QAGE CODE 00779

DRAWING NO. 1734099

RESTRICTED 70

SCALE

SHEET 3 of 5

REV H1

X-ON Electronics

Largest Supplier of Electrical and Electronic Components

Click to view similar products for [Headers & Wire Housings](#) category:

Click to view products by [TE Connectivity](#) manufacturer:

Other Similar products are found below :

[892-18-020-10-001101](#) [58102-G61-06LF](#) [582553-1](#) [0009485154](#) [009176003701906](#) [0050291907](#) [LY20-4P-DT1-P1E-BR](#) [02.125.8002.8](#)
[609-3404](#) [61062-3](#) [61082-181009](#) [622-3653LF](#) [63453-116](#) [636-1030](#) [636-1427](#) [636-3427](#) [636-4007](#) [641938-9](#) [641991-4](#) [644827-2](#) [65817-010LF](#) [65817-015LF](#) [65863-015LF](#) [66207-023LF](#) [67095-007LF](#) [67601157](#) [68645-018](#) [68648-049](#) [70.362.1628.0](#) [70-4210](#) [70-4226B](#) [70-4853B](#) [707-5020](#) [707-5028](#) [71.350.2428.0](#) [71918-208LF](#) [71961-016LF](#) [733-134](#) [733-162](#) [754199-000](#) [760-3052](#) [787-8014-00](#) [79531-3000](#)
[FCN-360C032-B](#) [FCN-367T-T012/H](#) [FCN-723D010/2](#) [80.063.4001.1](#) [800-90-001-10-001000](#) [800-90-010-10-002000](#) [801-43-002-10-013000](#)