

P	LTR	DESCRIPTION	DATE	DMN	APVD
-	-	SEE SHEET 1	-	-	-

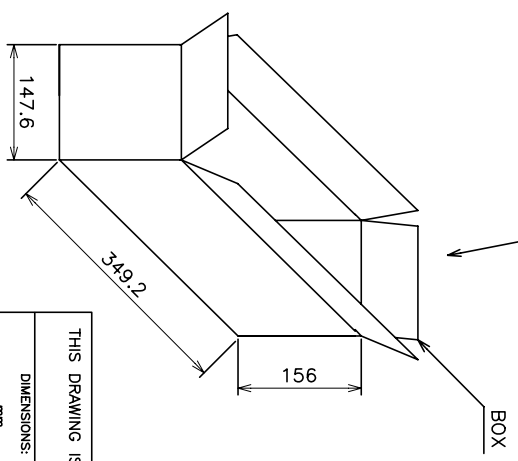
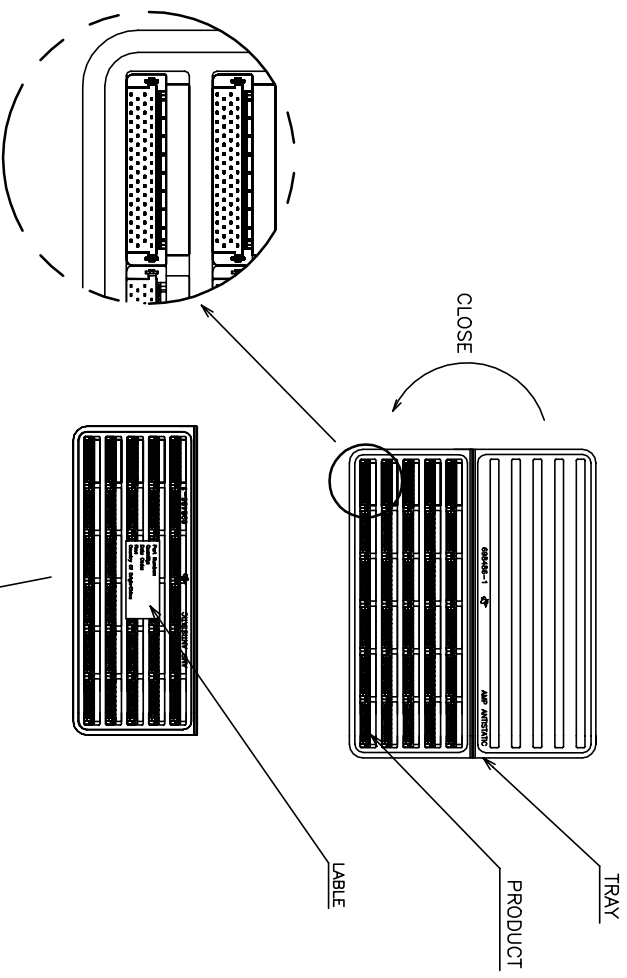

POS.	QTY/ TRAY	TRAY/ BOX	QTY/ BOX	N/W (KG)	G/W (KG)	PART NUMBER
40	45	10	450	1.71	2.66	5-1734099-4
						6-1734099-8
						3-1734099-8
						1-1734099-8
160	10	10	100	1.18	2.13	5-1734099-6
						3-1734099-6
						1-1734099-6
120	15	10	150	1.20	2.15	3-1734099-2
						1-1734099-2
68	30	10	300	1.69	2.64	4-1734099-7
						2-1734099-7
						1734099-7
60	30	10	300	1.53	2.48	4-1734099-6
						2-1734099-6
						1734099-6
50	35	10	350	1.58	2.56	4-1734099-5
						2-1734099-5
						1734099-5
40	45	10	450	1.71	2.66	4-1734099-4
						2-1734099-4
						1734099-4

THIS DRAWING IS A CONTROLLED DOCUMENT.

DIMENSIONS:	TOLERANCES UNLESS OTHERWISE SPECIFIED:
mm	
0 P/C	±
1 P/C	±
2 P/C	±
3 P/C	±
4 P/C	±
ANGLES	±

DMN	CHK	APVD
-	-	-

NAME	SIZE	QAGE CODE	DRAWING NO	RESTRICTED TO
PLUG ASSEMBLY, R/A, BTB, CHAMP .050, SERIES I	A3	00779	1734099	

MATERIAL	FINISH	WEIGHT	CUSTOMER DRAWING
-	-	-	-

REVISIONS					
P	LTR	DESCRIPTION	DATE	DMN	APVD
-	-	SEE SHEET 1	-	-	-

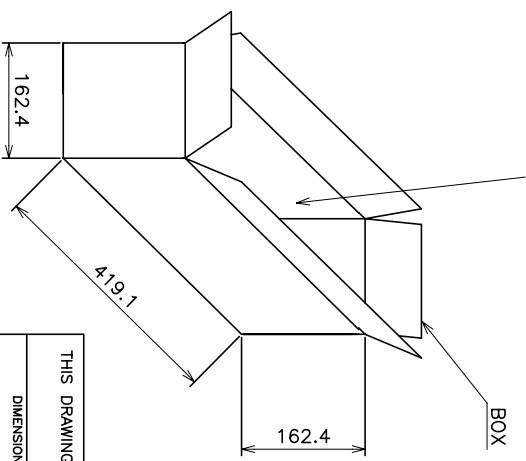
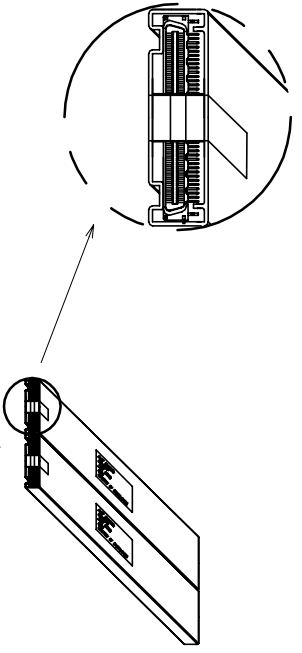
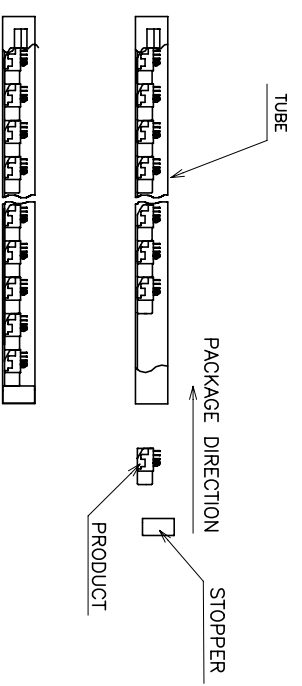

POS.	QTY/ TUBE	TUBE/ BOX	QTY/ BOX	N/W (KG)	G/W (KG)	PART NUMBER
100	21	16	336	2.60	3.44	5-1734099-0 3-1734099-0 1-1734099-0
80	21	16	336	2.15	3.00	4-1734099-8 2-1734099-8 1734099-8

THIS DRAWING IS A CONTROLLED DOCUMENT.

DIMENSIONS:	TOLERANCES UNLESS OTHERWISE SPECIFIED:
mm	
0 P/C	±
1 P/C	±
2 P/C	±
3 P/C	±
4 P/C	±
ANGLES	±
FINISH	

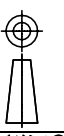

DMN	CHK	APVD	PRODUCT SPEC	APPLICATION SPEC	WEIGHT
-	-	-	-	-	-

STE TE Connectivity

PLUG ASSEMBLY, R/A,
BTB, CHAMP .050, SERIES I

NAME

SIZE A3

CAGE CODE 00779

DRAWING NO. 1734099

RESTRICTED FOR CUSTOMER DRAWING

SCALE -

SHEET 4 OF 5

REV H1

REVISONS		DESCRIPTION	DATE	DMN	APVD
P	LIR	SEE SHEET 1	-	-	-

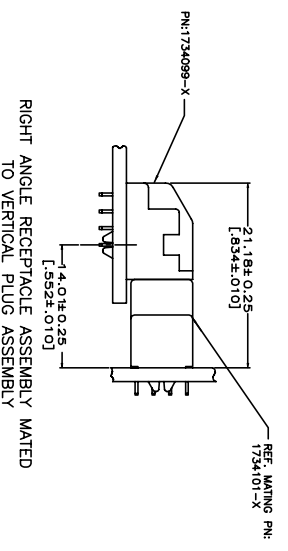
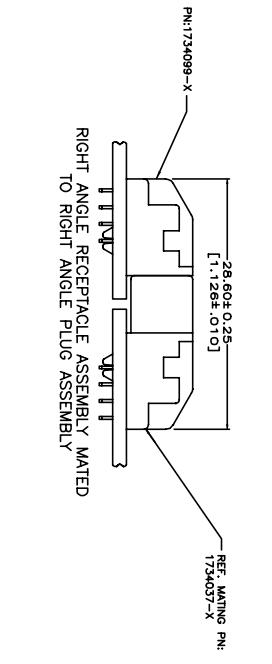
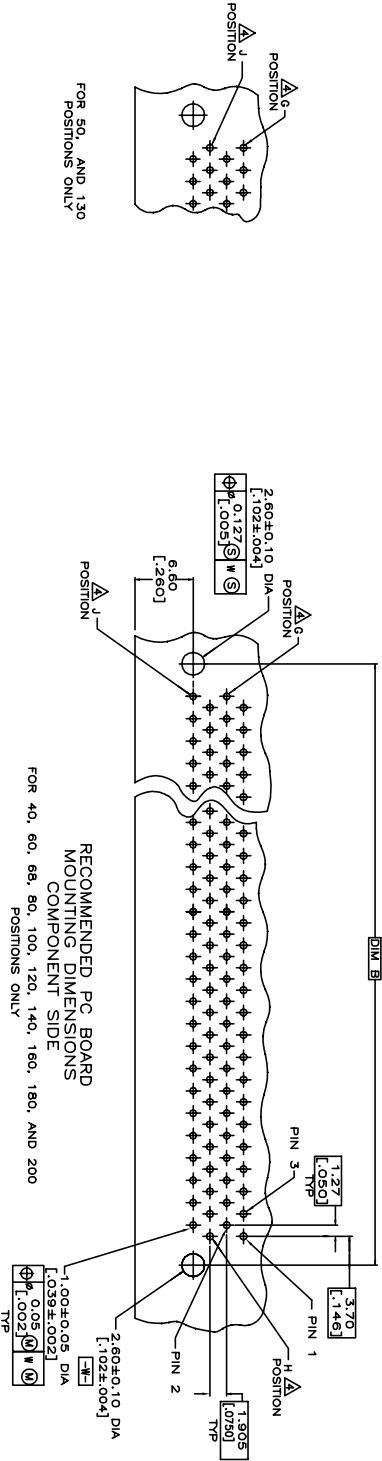

RECOMMENDED PC BOARD MOUNTING DIMENSIONS COMPONENT SIDE

THIS DRAWING IS A CONTROLLED DOCUMENT.

DIM	CHK	APVD	NAME
-	-	-	-

DIMENSIONS:	TOLERANCES UNLESS OTHERWISE SPECIFIED:
mm	0 P/C ±
	1 P/C ±
	2 P/C ±
	3 P/C ±
	4 P/C ±
	ANGLES ±

MATERIAL	FINISH	WEIGHT
-	-	-

STE TE Connectivity

PLUG ASSEMBLY, R/A,
BTB, CHAMP .050, SERIES I

SIZE	CAGE CODE	DRAWING NO	RESTRICTED TO
A3	00779	1734099	-

CUSTOMER DRAWING

SCALE - SHEET 3 OF 5 REV H1

X-ON Electronics

Largest Supplier of Electrical and Electronic Components

Click to view similar products for [Board to Board & Mezzanine Connectors](#) category:

Click to view products by [TE Connectivity](#) manufacturer:

Other Similar products are found below :

[589158040000018](#) [FCN-230C068-11](#) [FCN-268F012-G/BD](#) [FCN-268F036-G/BD](#) [FCN-268M012-G/0D](#) [FCN-268M024-G/1D](#) [FCN-723J004/1](#) [MIS-048-01-F-D-DP-K](#) [832-10-034-10-001000](#) [FX4C-80S-1.27DSA](#) [FCN-214Q030-G/0](#) [FCN-234P048-G/0](#) [FCN-235D050-G/C](#) [210-93-314-41-105000](#) [2-22603-0](#) [MDF7-40DP-2.54DSA\(55\)](#) [AXG720047](#) [5031084030](#) [MIT-114-03-F-D-K](#) [55323-1519](#) [DF33-2P-3.3DSA\(24\)](#) [YFT-20-05-H-03-SB-K](#) [503308-3040](#) [026-6203-PDB](#) [027-6203-PDB](#) [069159702701000](#) [10123981-102LF](#) [101A10019X](#) [55650-0588-C](#) [68684-306](#) [75140-7012](#) [589159005003045](#) [194261-1](#) [FCN-268F024-G0D](#) [10124054-515LF](#) [68685-603](#) [8-1616154-3](#) [MIS-019-01-F-D](#) [589159005002045](#) [541371078](#) [IL-WX-10PB-HF-B-E1000E](#) [FCN-268M024-G/3D](#) [20021832-06016C1LF](#) [KX15-20KLDL-E1000E](#) [MDF7-16DP-2.54DSA\(55\)](#) [AXE810124](#) [FCN-214J100-G/0](#) [FCN-230C068-E/S](#) [AXE812124](#) [AXE816124](#)