

THIS DRAWING IS UNPUBLISHED. RELEASED FOR PUBLICATION
 © COPYRIGHT 2011 BY TYCO ELECTRONICS CORPORATION. ALL RIGHTS RESERVED.

LOC		DIST		REVISIONS			
P	LTR	DESCRIPTION		DATE	DWN	APVD	
E1		REVISED (ECR-14-000556), ADD NEW PART NUMBER.		06JAN14	S.C.	H.L.	

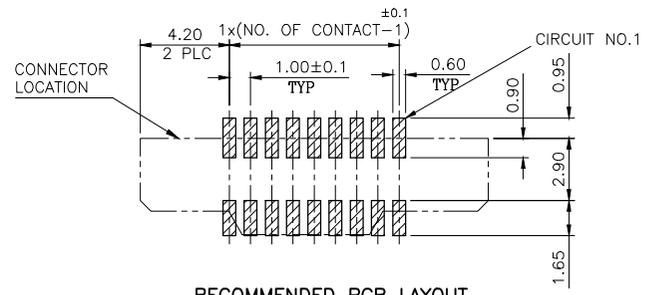
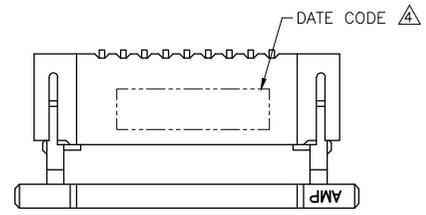

RECOMMENDED PCB LAYOUT
(TOLERANCE : \pm 0.05)

- NOTES:
- MATERIAL:
 - HOUSING: THERMOPLASTIC (PA9T)
UL94 V-0, COLOR: BLACK.
 - ACTUATOR: THERMOPLASTIC (PA9T)
UL94 V-0, COLOR: BLACK.
 - CONTACTS: PHOSPHOR BRONZE
 - MYLAR: CAPTON. THICKNESS: 0.12. COLOR: YELLOW
 - FINISH:
 - CONTACT: GOLD FLASH PLATING OVERALL.
1.27mm (50m") MIN. NICKEL UNDERPLATING OVERALL.
 - REFLOW SOLDER CAPABLE TO 260°C PER TEC-109-201, CONDITION B.
 - Δ WITHOUT DATE CODE FOR 8 POSITION UNDER.
 - Δ MYLAR ATTACHED FOR PN 6-1734248-0 ONLY

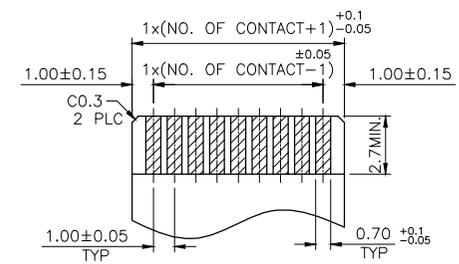
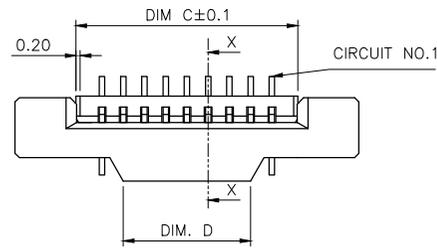

APPLICABLE FPC
RECOMMENDED DIMENSION
(THICKNESS:0.3 \pm 0.05)

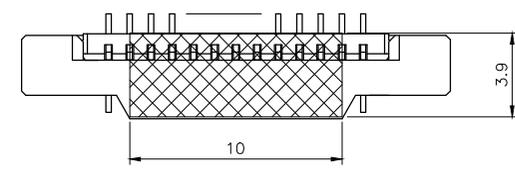
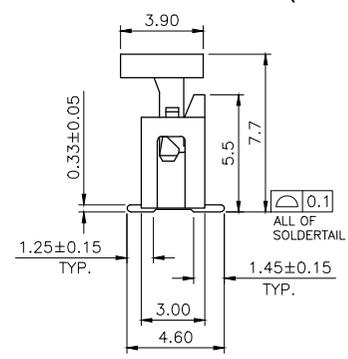
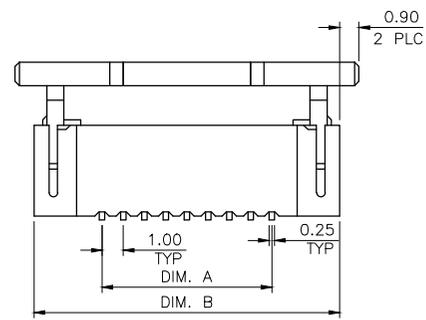

W/ MYLAR
 Δ (FOR 6-1734248-0 ONLY)

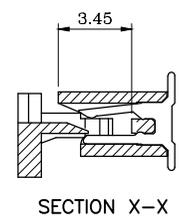

STATUS	DIM D	DIM C	DIM B	DIM A	POS.	PART NUMBER
ACTIVE	27	31.40	35.6	29.0	30	6-1734248-0
	37	41.40	45.6	39.0	40	4-1734248-0
	36	40.40	44.6	38.0	39	3-1734248-9
	35	39.40	43.6	37.0	38	3-1734248-8
	34	38.40	42.6	36.0	37	3-1734248-7
	33	37.40	41.6	35.0	36	3-1734248-6
OBSOLETE	32	36.40	40.6	34.0	35	3-1734248-5
	31	35.40	39.6	33.0	34	3-1734248-4
	30	34.40	38.6	32.0	33	3-1734248-3
	29	33.40	37.6	31.0	32	3-1734248-2
	28	32.40	36.6	30.0	31	3-1734248-1
ACTIVE	27	31.40	35.6	29.0	30	3-1734248-0
	26	30.40	34.6	28.0	29	2-1734248-9
	25	29.40	33.6	27.0	28	2-1734248-8
	24	28.40	32.6	26.0	27	2-1734248-7
	23	27.40	31.6	25.0	26	2-1734248-6
	22	26.40	30.6	24.0	25	2-1734248-5
	21	25.40	29.6	23.0	24	2-1734248-4
OBSOLETE	20	24.40	28.6	22.0	23	2-1734248-3
	19	23.40	27.6	21.0	22	2-1734248-2
	18	22.40	26.6	20.0	21	2-1734248-1
	17	21.40	25.6	19.0	20	2-1734248-0
	16	20.40	24.6	18.0	19	1-1734248-9
	15	19.40	23.6	17.0	18	1-1734248-8
	14	18.40	22.6	16.0	17	1-1734248-7
	13	17.40	21.6	15.0	16	1-1734248-6
	12	16.40	20.6	14.0	15	1-1734248-5
	11	15.40	19.6	13.0	14	1-1734248-4
	10	14.40	18.6	12.0	13	1-1734248-3
ACTIVE	9	13.40	17.6	11.0	12	1-1734248-2
	8	12.40	16.6	10.0	11	1-1734248-1
	7	11.40	15.6	9.0	10	1-1734248-0
	6	10.40	14.6	8.0	9	1734248-9
	5	9.40	13.6	7.0	8	1734248-8
	4	8.40	12.6	6.0	7	1734248-7
	3	7.40	11.6	5.0	6	1734248-6
	2	6.40	10.6	4.0	5	1734248-5
	2	5.40	9.6	3.0	4	1734248-4
	2	4.40	8.6	2.0	3	1734248-3

THIS DRAWING IS A CONTROLLED DOCUMENT.		DWN H. HUANG 30MAR2007	TE Connectivity	
DIMENSIONS: mm		CHK S. HOU 30MAR2007		
TOLERANCES UNLESS OTHERWISE SPECIFIED:		APVD W.J. KF 30MAR2007	NAME	
0 PLC \pm -		PRODUCT SPEC	108-57080	
1 PLC \pm 0.3		APPLICATION SPEC	108-57080	
2 PLC \pm 0.2			SIZE	
3 PLC \pm -			CAGE CODE	
4 PLC \pm -			DRAWING NO	
ANGLES \pm 3'			RESTRICTED TO	
MATERIAL SEE NOTE	FINISH SEE NOTE	WEIGHT -	A300779 C=1734248	
CUSTOMER DRAWING		SCALE	SHEET	REV
			1 of 2	E1

X-ON Electronics

Largest Supplier of Electrical and Electronic Components

Click to view similar products for [FFC & FPC Connectors](#) category:

Click to view products by [TE Connectivity](#) manufacturer:

Other Similar products are found below :

[FPH-1422G](#) [FPH-1602G](#) [K-FC20](#) [FH29B-80S-0.2SHW\(99\)](#) [FPH-2022G](#) [AYF332735](#) [52610-1075](#) [52610-1275](#) [52610-1934](#) [501864-3091-TR225](#) [086222026001800](#) [52610-0675](#) [62684-36210E9ALF](#) [52746-1671-TR250](#) [10051922-2810EHLF](#) [6-520415-9](#) [SFV6R-1STE9HLF](#) [XF3M-2915-1B-R100](#) [1658549-1](#) [AYF534065TA](#) [AYF351525](#) [086212040340800+](#) [AYF530365TA](#) [67000-014LF](#) [67000-004LF](#) [006207341915000+](#) [DS1020-19RT1D](#) [67000-003LF](#) [67000-011LF](#) [67000-016LF](#) [HFW14R-2STE9LF](#) [SFV32R-2STBE9HLF](#) [SFW12R-5STE9LF](#) [SFW18R-1STAE9LF](#) [SFW4R-5STE9LF](#) [52807-0430](#) [046283021002868+](#) [THD1015-8CL-SN](#) [67000-006LF](#) [502250-8027](#) [104267-9617](#) [66987-011LF](#) [AYF362535](#) [F0501-T-50-20T-R](#) [F1003-ZV-12-25T-R](#) [HFW8S-2STAE1HLF](#) [67000-008LF](#) [67000-012LF](#) [ECC576069EU](#) [F1002-B-20-20T-R](#)